



A Tomkins Company

# 2010

## MASTER AUTOMOTRIZ



**\$ 45.00**  
M.N

**Automóviles - Camionetas de 1996 al 2011**



MADE IN MEX



Timing Component Kit  
Caja de Distribución con  
Bomba de Agua

Poleas y Tensoros

Poleas y Tensoros

Timing Component Kit  
Caja de Distribución con  
Bomba de Agua

Timing Component Kit

TRICO HEAVY DUTY  
MegaVision



# ¿POR QUÉ SOMOS DIFERENTES?

- 1 Privilegio - Marca - Más de 52 años sirviendo al mercado mexicano.
- 2 Garantía - Todos nuestros productos están garantizados por defectos de fabricación.
- 3 Calidad de Equipo Original - Gates es proveedor de las principales armadoras de autos y camiones a nivel mundial.
- 4 La oferta de productos más completa del mercado - Bandas Micro-V KP, Bandas Micro V Stretch Fit, Bandas Timing, Bandas en V O-R Power, GS, XL, TRL, Bandas para Scooter, Poleas, Tensores, Kits de Distribución, Kits Drive-Angle para bandas de serpiente, Limpiaaparafísas, Termostatos, Distribuidores, Bombas de Dirección Hidráulica, Abrazaderas, Mangueras de Silicón, Manguera-Canvas, Mangueras Flexibles, Mangueras para combustible, Ensamble de Dirección Hidráulica, y más (Ver Índice de este catálogo).
- 5 Cinco Centros de Distribución y Servicio - Ubicados estratégicamente en toda la república. Cada uno de estos Centros cuenta con un INVENTARIO de productos adecuado a las necesidades de la región, para ofrecer el mejor SERVICIO a nuestros clientes.
- 6 Catálogo actualizado - con la mayor cobertura en aplicaciones y variedad de productos hasta modelos 2011.
- 7 Revista "Sin Parar" - La cual llega a Distribuidores, Refaccionarias, Talleres Mecánicos y Flotas, con la información más Actualizada de aplicaciones y nuevos productos.
- 8 Capacitación - Gates de México, ofrece capacitación a toda la red de distribuidores, con el propósito de difundir todos los ventajas competitivos de nuestros productos, servicios y la importancia de la calidad y seguridad para nuestros clientes.
- 9 La mejor Red de Distribuidores - Nuestra red de distribuidores de servicio especializado en cualquier zona de la República Mexicana.
- 10 Asesoría técnica en productos - Teléfono sin costo 01 800 774 2832, Revista "Sin Parar" y correo electrónico [sinparar@gates.com](mailto:sinparar@gates.com) [www.gates.com.mx](http://www.gates.com.mx)

Otras líneas Gates - Hidráulica, Neumática y Empaque.



## Master Automotriz 2010 INDICE



<b>PRODUCTOS GATES</b>					
<b>Característica y especificaciones</b>					
Bandas Micro-V® STRETCH FIT™	A-2	Bandas para motonetas y cuatrimotos PowerLink®	A-28	<b>Destelladores (Flashers) - TRIDON</b>	A-101
Kits PowerGrip® TCK's con Bomba de Agua	A-4	Bandas Hi-Power® II	A-28	<b>Destelladores Electrónicos</b>	A-102
Kits para Bandas de Tiempo	A-6	Bandas Tri-Power®	A-28	Temperaturas alternas disponibles para termostatos de Servicio Ligero y SUPERSTAT®	A-103
Kits para bandas Micro-V®	A-6	Bandas Vulco®	A-28	TABLA DE INTERCAMBIO DE TERMOSTATOS	A-105
DriveAlign® - Tensores automáticos para bandas Micro-V®	A-7	Bandas PowerBand®	A-28	Juntas de Salida de Agua Sello	A-107
Tensores automáticos y Poleas para bandas de Tiempo	A-8	<b>Herramientas:</b>			
Tensores hidráulicos	A-10	Alineador Láser DriveAlign™	A-29	<b>APLICACIÓN POR ARMADORA</b>	
Limpiaparabrisas TRICO	A-11	Medidor Banda Micro-V®	A-29		
Limpiaparabrisas NEOFORM®	A-11	Localizador Banda-V	A-29	<b>ACURA</b>	
Limpiaparabrisas Megavision	A-12	Kit Completo para reemplazo de bandas Timing	A-29	MDX	1
Ensamblajes de Dirección Hidráulica	A-12	KrikIt II Micro-V® - Medidor de tensión de bandas	A-30	RDX	1
Bombas de Dirección Hidráulica	A-12	KrikIt V-Bandas Medidor de tensión	A-30	RL	1
Abrazaderas Sin Fin	A-13	Probador de tensión para bandas Timing	A-30	TL	1
Abrazaderas de Servicio Pesado	A-13	Herramienta para tensar las bandas de Serpentin	A-30	TSX	2
Termostatos de Servicio Pesado	A-14	<b>FORMAS Y DIMENSIONES</b>		<b>ALFA ROMEO</b>	
Destelladores (Flashers)	A-14	Guía de Poleas DriveAlign®	A-32	ALFA 147	3
Tapones		Guía de Poleas Decopladoras DriveAlign®	A-34	ALFA 159	3
Gasolina	A-15	Componentes de una Polea Decopladora DriveAlign	A-35	ALFA BRERA	3
Radiador	A-15	Guía de Tensores DriveAlign® y PowerGrip®	A-36	<b>AUDI</b>	
Aceite	A-15	Nomenclatura de Bandas	A-47	A3	3
Mangueras de Enfriamiento		Banda V Dentada	A-49	A4	3
Mangueras Curvas	A-17	Banda GS® PLATINUM QUALITY	A-50	A6	4
Mangueras Twister	A-20	Banda Vulco®	A-50	A8	5
Mangueras de Combustible		Banda Super HC®	A-51	A8 QUATTRO	5
FLH	A-22	Banda Truck Belt	A-51	ALLROAD QUATTRO	5
FLC	A-22	Banda PowerBand®	A-52	Q5	6
MPI / Fuel Injection	A-23	Banda Tri-Power®	A-52	Q7	6
Sumergible	A-23	Banda Hi-Power® II	A-53	S4 QUATTRO	6
Fuel Fill	A-24	Banda Micro-V®	A-54	TT	6
Filler Neck	A-24	Banda de Distribución o Timing	A-57	<b>BMW</b>	
Mangueras de Calefacción 30T	A-25	<b>Tabla de Aplicaciones de kits para bandas Micro-V® (Serpentin)</b>	A-61	318I	6
Manguera de Limpiaparabrisas 4106	A-25	<b>Tabla de Aplicaciones de kits para PowerGrip® (Serpentin)</b>	A-68	318TI	6
Unicoil	A-25	<b>Tabla Aplicaciones de bandas para motonetas – PowerLink®</b>	A-75	320I	7
Reductores de Diámetro	A-26	<b>Aplicaciones de bandas para Cuatrimotos – PowerLink®</b>	A-75	323CI	7
Bandas y componentes de transmisión:		<b>Tabla de aplicaciones Limpiaparabrisas Automotrices</b>	A-80	323I	7
Bandas Micro-V® AT (Serpentin)	A-27	<b>H - Abrazaderas Gates</b>	A-100	323IS	7
Bandas Micro-V® de Doble lado	A-27	<b>HP - Abrazaderas Gates</b>	A-100	325CI	7
TR y XL® bandas en V	A-27	<b>TBLS - Abrazaderas Gates</b>	A-100	325I	7
Bandas Timing para árbol de levas	A-27	<b>TB - Abrazaderas Gates</b>	A-100	325XI	7
				328I	8
				328IS	8
				330CI	8
				330XI	8
				525I	8
				528I	9
				530I	9

**GATES: LA MARCA DE MÁS PRESTIGIO EN BANDAS, MANGUERAS, HIDRÁULICA Y NEUMÁTICA.**



## Master Automotriz 2010 INDICE

540I	9	CHEVY PICK-UP	28	SEBRING	66
545I	9	CHEVY POP	29	TOWN & COUNTRY	67
5501	9	CHEVY SWING	29	VOYAGER	68
645CI	10	CHEYENNE	30	<b>DODGE</b>	
6501	10	COLORADO	31	ADVENTURER	70
740I	10	CORSA	31	AVENGER	70
740IL	10	CORVETTE	32	CALIBER	70
745I	10	CRUZE	33	CARAVAN	70
745LI	10	CUTLASS	33	CHARGER	71
750IL	10	EQUINOX	33	DAKOTA	72
760I	10	EXPRESS	33	DURANGO	72
760LI	10	EXPRESS CARGO VAN	38	INTREPID	74
M	11	EXPRESS VAN	38	JOURNEY	76
M3	11	EXPRESS VAN LUJO	39	NEON	76
M5	11	EXPRESS VAN PASAJEROS	39	NITRO	78
X3	11	HHR	39	RAM 1500	78
X5	11	IMPALA	39	RAM 2500	79
Z3	12	LUMINA	41	RAM 3500	80
Z4	12	LUV	41	RAM 4000	81
<b>BUICK</b>		MALIBU	41	RAM 6500 DIESEL	82
ENCLAVE	12	MERIVA	43	RAM CHARGER	82
LACROSSE	13	MONTE CARLO	43	RAM MAXI VAN 1500	82
<b>CADILLAC</b>		MONZA	43	RAM MAXI VAN 2500	82
CATERA	13	OPTRA	44	RAM MAXI VAN 3500	83
CTS	13	P-30	45	RAM MAXI WAGON 3500	83
DEVILLE	13	S-10	45	RAM RUNNER	83
DTS	14	SILVERADO	46	RAM SERIES PICKUP	83
EL DORADO	14	SONORA	50	RAM WAGON 1500	85
ESCALADE	15	SUBURBAN	51	RAM WAGON 2500	86
SEVILLE	16	TAHOE	54	RAM WAGON 3500	86
SRX	17	TIGRA	55	STRATUS	86
<b>CHEVROLET</b>		TORNADO	55	VAN 1000	89
400SS	17	TRACKER	55	VIPER	89
ASTRA	17	TRAILBLAZER	56	<b>FAW</b>	
AVALANCHE	18	TRAVERSE	57	F1	89
AVEO	19	UPLANDER	57	F4	89
BLAZER	19	VECTRA	58	F5	89
C y K SERIES PICKUP	20	VENTURE	58	<b>FIAT</b>	
C-1500	22	ZAFIRA	59	BRAVO	89
C-2500	22	<b>CHRYSLER</b>		DUCATO	89
C-3500	22	300 C	60	GRANDE PUNTO	90
CAMARO Z28	23	300M	61	PALIO	90
CAPTIVA	23	ASPEN	61	PALIO ADVENTURE	90
CAVALIER	24	CIRRUS	62	PANDA	90
CAVALIER Z24	25	CONCORDE	63	<b>FORD</b>	
CENTURY	25	CROSSFIRE	64	AEROSTAR	90
CHEVY	25	GRAND VOYAGER	64	CONTOUR	91
CHEVY C2	26	NEW YORKER	64	COURIER	92
CHEVY C2 SEDAN	26	PACIFICA	64	CROWN VICTORIA	92
CHEVY JOY	27	PT CRUISER	65	E SERIES VAN	92

**GATES: LA MARCA DE MÁS PRESTIGIO EN BANDAS, MANGUERAS,  
HIDRÁULICA Y NEUMÁTICA.**





## Master Automotriz 2010 INDICE



ECOSPORT	95	PILOT	130	C240	149
EDGE	95	RIDGELINE	131	C280	149
ESCAPE	96	<b>HUMMER</b>		C320	149
ESCORT	97	H1	131	C43	149
EXCURSION	98	H2	131	CL500	149
EXPEDITION	99	H3	132	CL55	150
EXPLORER	100	<b>HYUNDAI</b>		CL600	150
EXPLORER SPORT TRAC	103	ATOS	132	CLK320	150
F SERIES PICKUP	104	ATTITUDE	133	CLK430	150
F-150	105	H100 VAN/WAGON	134	CLK500	150
F-250	106	H100	134	CLK55	150
F-250 SUPER DUTY	107	VERNA	134	E320	150
F-250 XL	107	<b>INFINITI</b>		E430	151
F-250 XLT	108	INFINITI I30	135	E55	151
F-350 SUPER DUTY	108	INFINITI Q45	135	ML320	151
F-350 XL	109	Q45	135	ML430	151
F-450 SUPER DUTY	109	<b>JAGUAR</b>		S420	151
F-550 SUPER DUTY	110	S-TYPE	135	S430	151
FIESTA	111	<b>JEEP</b>		S500	151
FIVE HUNDRED	111	CHEROKEE	136	S55	151
FOCUS	112	COMMANDER	137	S600	152
FREESTAR	113	COMPASS	137	S600 L	152
FUSION	113	GRAND CHEROKEE	137	SL500	152
IKON	114	LIBERTY	140	SL55	152
KA	114	PATRIOT	141	SL600	152
LOBO	114	WRANGLER	141	SLK230	152
MONDEO	116	<b>LAND ROVER</b>		SLK320	152
MUSTANG	116	DISCOVERY	143	SLK350	152
MUSTANG SHELBY	118	DISCOVERY SERIES II	143	SPRINTER	152
RANGER	118	FREELANDER	144	VITO	152
RANGER F-100	120	RANGE ROVER	144	<b>MERCURY</b>	
SUPER DUTY PICKUP	120	<b>LINCOLN</b>		GRAND MARQUIS	153
SUPER DUTY VAN	121	AVIATOR	144	MARINER	153
THUNDERBIRD	122	CONTINENTAL	144	MILAN	154
TRANSIT	122	LS	145	MYSTIQUE	144
WINDSTAR	122	MARK LT	145	SABLE	155
ZX2	123	MARK VIII	145	SABLE / TAURUS	155
<b>GMC</b>		MKX	145	<b>MG</b>	
ACADIA	123	MKZ	145	TF	156
CANYON	123	NAVIGATOR	145	ZR	156
SIERRA	124	TOWN CAR	147	<b>MINI</b>	
YUKON	124	<b>MAZDA</b>		COOPER	156
<b>HONDA</b>		CX-7	147	<b>MITSUBISHI</b>	
ACCORD	125	CX-9	148	ECLIPSE	157
CITY	127	MAZDA 3	148	ENDEAVOR	157
CIVIC	127	MAZDA 5	148	GALANT	157
CIVIC HIBRIDO	128	MAZDA 6	148	GRANDIS	158
CR-V	128	MX-5 MIATA	149	L200	158
FIT	129	<b>MERCEDES BENZ</b>		LANCER	158
ODYSSEY	129	C230	149	MONTERO	159

**GATES: LA MARCA DE MÁS PRESTIGIO EN BANDAS, MANGUERAS,  
HIDRÁULICA Y NEUMÁTICA.**



## Master Automotriz 2010 INDICE



MONTERO SPORT	159	G4	180	<b>TOYOTA</b>	
OUTLANDER	159	G5	180	4 RUNNER	195
<b>NISSAN</b>		G6	180	AVANZA	196
240SX	160	G8	181	CAMRY	196
350Z	160	GRAND AM	181	COROLLA	197
370Z	160	GRAND PRIX	182	FJ CRUISER	198
ALMERA	160	MATIZ G2	184	HIACE	198
ALTIMA	160	MONTANA	184	HIGHLANDER	198
APRIO	162	SOLSTICE	184	HILUX	198
ARMADA	162	SUNFIRE	184	LAND CRUISER	198
CHASIS	163	TORRENT	186	MATRIX	199
ESTACAS – NP300	163	TRANS AM FIREBIRD	186	RAV 4	199
ESTAQUITAS	163	<b>PORSCHE</b>		RUSH	200
FRONTIER	163	911	187	SEQUOIA	200
KING CAB	165	BOXSTER	187	SIENNA	200
LUCCINO	165	<b>RENAULT</b>		SOLARA	201
MAXIMA	165	CLIO	187	TACOMA	201
MICRA	166	EUROCLIO	188	TUNDRA	202
MURANO	166	KOLEOS	189	YARIS	202
PATHFINDER	167	LAGUNA	189	<b>VOLKSWAGEN</b>	
PATHFINDER LE 4X2	168	MEGANE	189	BEETLE	202
PICK-UP	168	SANDERO	189	BORA	204
PICK-UP – NP300	168	SCENIC	189	BORA SPORTWAGEN	205
PICK-UP DOBLE CABINA	168	STEPWAY	190	CABRIO	205
PLATINA	168	TRAFIC	190	CARAVELLE	205
QUEST	169	<b>SAAB</b>		COMBI	205
ROGUE	170	9 - 3	190	CRAFTER	206
SENTRA	170	9 - 5	190	CROSSFOX	206
TIIDA	172	<b>SEAT</b>		DERBY	206
TITAN	172	AHLAMBRA	191	EUROVAN	206
TSURU	173	ALTEA	191	GLI	207
URVAN	174	CORDOBA	191	GOL	207
XTERRA	174	IBIZA	192	GOLF	207
X-TRAIL	175	LEON	193	GTI	210
<b>OLDSMOBILE</b>		TOLEDO	193	JETTA	210
EIGHTY EIGHT	175	<b>SMART</b>		LUPO	214
<b>PEUGEOT</b>		FORTWO	193	PANEL	214
206	176	<b>SUBARU</b>		PASSAT	214
207	176	B9 TRIBECA	193	POINTER	216
306	177	FORESTER	193	POINTER PICK-UP	217
307	177	IMPREZA	193	POINTER STATION WAGON	217
406	177	LEGACY	193	POLO	217
407	177	OUTBACK	194	ROUTAN	218
GRAND RAID	177	<b>SUZUKI</b>		SAVEIRO	218
PARTNER	178	AERIO	194	SEDAN	218
<b>PONTIAC</b>		GRAND VITARA	194	SHARAN	218
AZTEK	178	KIZASHI	194	SPORTVAN	218
BONNEVILLE	178	SWIFT	194	TIGUAN	218
FIREBIRD TRANS AM	179	SX4	195	TOUAREG	218
G3	180	XL-7	195	TRANSPORTER	219

**GATES: LA MARCA DE MÁS PRESTIGIO EN BANDAS, MANGUERAS,  
HIDRÁULICA Y NEUMÁTICA.**



## Master Automotriz 2010 INDICE

VW VAN	219	Tapones de Gasolina	489		
<b>VOLVO</b>		Tapones de Radiador	504		
C30	219	Tensores y Poleas	515		
C70	219	Termostatos	577		
C70 T5	220	Equivalencias contra Equipo Original	593		
S40	220				
S60	220				
S70	220				
S80	220				
V40	222				
V70	222				
XC90	222				
<b>APLICACIÓN POR PRODUCTO</b>					
Bandas	223				
TCKS & COMPONENTES	229				
Bomba de Dirección Hidráulica	306				
Ensamble de Dirección Hidráulica	308				
Manguera de Enfriamiento	331				
Tapones de Aceite	482				

**GATES: LA MARCA DE MÁS PRESTIGIO EN BANDAS, MANGUERAS, HIDRÁULICA Y NEUMÁTICA.**



## Master Automotriz 2010 INDICE



### Instrucciones de Uso

Use este catálogo cuando desee saber qué productos corresponden a un determinado vehículo.

- Busque el nombre del fabricante - Armadora (General Motors, Nissan, Ford, Chrysler, etc.)
- Busque la marca (nombre) del vehículo.
- Compare el motor (4 Cil, 1.8Lts.) y accesorios (aire acondicionado, dirección hidráulica, etc.)
- Identifique el producto por la posición (serpentín, aire acondicionado, dirección hidráulica, etc.)

### GLOSARIO DE TERMINOS

Cil	Cilindros	C/DH	Con dirección hidráulica	S/COM	Sin compresor de aire
6V	6 cilindros en V	S/DH	Sin dirección hidráulica	C/COM	Con compresor de aire
Lts	Litros (desplazamiento)	S/AA	Sin aire acondicionado	SOHC	Arbol de levas sencillo
6L	6 cilindros en línea	C/AA	Con aire acondicionado	DOHC	Doble árbol de levas
6V	6 cilindros en V	CT	Control de temperatura	PCD	Pulgadas cúbicas
8V	8 cilindros en V	FI	Fuel injection	TDI	Turbo Diesel
10V	10 cilindros en V	Auto	Transmisión automática	CVT	Transmisión
Lts	Litros (desplazamiento)	STD	Transmisión manual		

**GATES: LA MARCA DE MÁS PRESTIGIO EN BANDAS, MANGUERAS,  
HIDRÁULICA Y NEUMÁTICA.**



**Master Automotriz 2010**  
**Productos Gates \* Características y especificaciones**



**BANDAS MICRO-V® STRETCH FIT™**

Cada vez más los fabricantes de automóviles comercializan vehículos que no están equipados con un dispositivo de tensado para la transmisión de los accesorios. Las bandas **Stretch Fit™** son la respuesta ideal para estas aplicaciones especiales. Están pretensadas sobre las poleas, manteniendo la tensión suficiente para una transmisión de potencia eficiente durante un largo período de tiempo, pero también lo suficientemente baja para permitir la instalación fácil y evitar fallas en los demás componentes del motor.

**Características técnicas:**

Bandas de alta tecnología diseñadas para el Equipo Original, usan un refuerzo especial en las cuerda **TwistLock™** que permite mantener una tensión adecuada durante toda la vida de la banda.

**Recomendaciones para su Instalación:**

Cada aplicación tiene instrucciones de instalación únicas. Las instrucciones se muestran en el interior de la Fajilla de cada banda. Es muy importante que estas instrucciones se sigan al pie de la letra para no causar daños a la banda en el momento de su instalación.

Aquí se muestran gráficamente algunos proceso para la instalación de estas bandas:



**Nota Importante:** Se requiere de la longitud específica para cada aplicación, es decir, no existen intercambios con otras bandas Micro-V estándar.

Es necesario contar con una herramienta especial para la instalación de las bandas **Micro-V® Stretch Fit™**, esta herramienta es comercializada por Gates de México, con la siguiente identificación de producto (**No. Parte: 91030**)



**No. Parte 91030**



**Master Automotriz 2010**  
**Productos Gates \* Características y especificaciones**

**Lista de principales aplicaciones con parque vehicular en México:**

Código	Banda	Años	Marca	Modelo	Motor
85560009	K040355 SF	2009-10	Cadillac	Escalade	6.2 Lts
		2009-10	Chevrolet	Express / Suburban / Silverado / Tahoe	4.8 Lts. / 5.3 Lts.
		2009-10	GMC	Savana / Yukon / Sierra / Avalanche	5.3 Lts. / 6.0 Lts.
		2009-10	Hummer	H2 / H3	5.3 Lts. / 6.2 Lts.
85560002	K040374 SF	2007-09	Dodge	Nitro	4.0 Lts.
85560000	K040352 SF	2007-09	Ford	Edge	3.5 Lts.
		2010 +	Ford	Fusion	3.5 Lts.
85560001	K040362 SF	2008-10	Dodge	Avenger	2.7 Lts.
		2008-10	Ford	Transit	2.2 Lts TDI
85560006	K030195 SF	2006-09	Ford	Fusion	3.0 Lts.
		2006-08	Ford	Escape	3.0 Lts.
		2006-08	Lincoln	Zephyr	3.0 Lts.
		2006-08	Mercury	Milan / Mariner	3.0 Lts.
74680016	91030	MicroV Strech Fit herramienta de instalación			

**Próximamente bandas Micro-V Stretch Fit™ para SAVEIRO y GOL**

**Nuevo**

## KITS PowerGrip® TCK's CON BOMBA DE AGUA



Un mal funcionamiento del sistema de transmisión por banda de distribución puede causar graves problemas. Por eso, cuando la bomba de agua y otros componentes fallan afectan directamente a la banda de distribución, por esta razón **Gates recomienda el reemplazo completo de todos los elementos de la transmisión (Banda Timing, Tensor, Poleas y Bomba de agua)**. La extensa gama de kits PowerGrip® de Gates le permite ofrecer a sus clientes un sistema de transmisión completo con **Calidad de Equipo Original**.

La bomba de agua es un componente vital del sistema de refrigeración del vehículo. Asegura un flujo continuo de líquido refrigerante a través del radiador y del motor. Las bombas de agua modernas se accionan por la banda de distribución.

Cuando la bomba de agua falla, el líquido refrigerante se filtra sobre la banda de distribución. Una contaminación prolongada de líquido refrigerante causará finalmente la ruptura de la banda de distribución.

Código	Descripción	Años	Aplicación	No. Comp.
77820329	TCKWP139	1987-2000	Dodge Caravan 3.0L / Hyundai Sonata 3.0L	3
77820330	TCKWP143	1988-1995	Honda Civic 1.5L	3
77820362	TCKWP157	1988-1991	Toyota Camry 2.5L	4
77820361	TCKWP163	1990-1994	Pontiac Sunbird 2.0L	3
77820360	TCKWP172	1990-1993	Subaru Legacy 2.2L	6
77820331	TCKWP184	1997-2001	Honda CR-V 2.0L	3
77820332	TCKWP184A	1990-1995	Acura Integra 1.8L	3
77820333	TCKWP186	1990-1997	Honda Accord / Prelude / Odyssey 2.2L	5
77820349	TCKWP193	1991-1995	Acura Legend 3.2L	3
77820350	TCKWP193A	1996-1998	Acura TL 3.2L	3
77820363	TCKWP194	1991-1996	Ford Escort 1.9L	3
77820364	TCKWP195	1991-1999	Mitsubishi 3000GT 3.0L	4
77820334	TCKWP199	1990-2001	Toyota Camry Celica Rav 4 MR2 2.0 2.2L	4
77820365	TCKWP200	1992-1993	Toyota Camry 3.0L	4
77820366	TCKWP211	1995-1998	Acura TL 2.5L	3
77820367	TCKWP211A	1992-1994	Acura Vigor 2.5L	3
77820368	TCKWP216	1992-1996	Honda Prelude 2.3L	5
77820369	TCKWP219	1993-1994	Dodge Intrepid 3.5L	3
77820335	TCKWP221	1994-1997	Honda Passport 3.2L   Izuzu Trooper 3.2L	4
77820336	TCKWP224	1996-2000	Honda Civic 1.6L	3
77820337	TCKWP224A	1992-199	Honda Civic 1.6L	3
77820374	TCKWP240	1993-1995	Toyota 4 Runner 3.0L	4



## Master Automotriz 2010

### Productos Gates \* Características y especificaciones

Código	Descripción	Años	Aplicación	No. Comp.
77820375	TCKWP240B	1994-1995	Toyota Pickup 3.0L	4
77820376	TCKWP240C	1989-1992	Toyota 4 Runner 3.0L	4
77820338	TCKWP244	1998-2002	Honda Accord 2.3L	5
77820339	TCKWP245	1995-1998	Dodge Neon Stratus 2.0L	3
77820340	TCKWP245A	1996-2005	Dodge Neon Stratus 2.0L	3
77820341	TCKWP245B	1996-2005	Dodge Neon Stratus 2.0L	3
77820342	TCKWP246	1995-1999	Chrysler Sebring 2.0L   Mitsubishi Eclipse 2.0L	4
77820377	TCKWP259	2001-2005	Dodge Sebring Stratus 3.0L   Mistubishi Eclipse 2.0L	4
77820378	TCKWP259A	1995-2000	Chrysler Cirrus Sebring 2.5L	4
77820343	TCKWP263	1995-1997	Honda Accord 2.7L	3
77820344	TCKWP265	2003-2008	Chrysler PT Cruiser 2.4L   Jeep Liberty Wrangler 2.4L	4
77820345	TCKWP265A	2003-2008	Chrysler PT Cruiser 2.4L   Jeep Liberty Wrangler 2.4L	4
77820346	TCKWP265B	1997-2002	Dodge Stratus Caravan 2.4L	4
77820347	TCKWP265C	2003-2006	Dodge Neon 2.4L	4
77820370	TCKWP279	1996-2003	Acura RL 3.5L	5
77820348	TCKWP281	1995-2002	Kia Sportage 2.0L	4
77820351	TCKWP283	2000-2004	Ford Focus 2.0L	3
77820352	TCKWP283A	1997-2002	Ford Escort 2.0L	3
77820379	TCKWP287	2003-2004	Mitsubishi Diamante Montero Sport 3.5L	4
77820353	TCKWP296	1998-2004	Volkswagen Golf Jetta Beetle 2.0L	3
77820354	TCKWP297	1998-2005	Volkswagen Passat 2.8L	5
77820371	TCKWP297A	2000-2004	Audi A6 4.2L	6
77820372	TCKWP297B	2002-2005	Audi Allroad Quattro 2.7L	5
77820355	TCKWP306	1999-2005	Volkswagen Golf Jetta Passat Beetle 1.8L	5
77820356	TCKWP306A	1999-2006	Audi A4 1.8L	5
77820357	TCKWP321	1998-2004	Volkswagen Golf Jetta Beetle 1.9L Diesel	6
77820358	TCKWP329	2003-2007	Honda Accord 3.0L	5
77820359	TCKWP331	1998-2007	Volvo V70 2.4L	4
	TCKWP203	2004-2010	Chevrolet Chevy 1.4L	3
	TCKWP077	2010-1981	Nissan Tsuru 1.6L 8 Valvulas	3
	TCKWP260	2008-1998	Volkswagen Pointer 1.8 L	3





## Master Automotriz 2010 Productos Gates \* Características y especificaciones

### Kits para bandas de Tiempo (árbol de levas)

Los kits PowerGrip® de Gates te proporcionan una solución completa para el sistema de sincronización de tu automóvil.

Con los kits para bandas de tiempo Gates, no tendrás que comprar los componentes (Banda, Tensores, poleas y tornillos) por separado, los encontrarás en un sólo kit con la garantía de que siempre estarás haciendo el reemplazo de estas piezas con las mismas características del equipo original.

Cada kit incluye todos los componentes para una aplicación en específico:

- Banda Timing
- Polea Tensora
- Polea loca
- Instrucciones de instalación



**Nuevo**

### Kits para bandas Micro-V® (Serpentín)

Con el nuevo kit para bandas Micro-V® AT, Gates ofrece al mercado todos los componentes necesarios para garantizar un reemplazo completo de la transmisión para accesorios en un sólo kit. Ya no hace falta pedir piezas separadas: los componentes metálicos y las bandas Micro-V® AT vienen en una sola caja, listos para ser instalados.

¡Ahorro de tiempo y comodidad en un sólo kit!

Los kit para bandas Micro-V® incluyen:

- 1 ó 2 Bandas Micro-V® AT
- 1 ó 2 Tensores DriveAlign® de resorte helicoidal
- Las poleas guías necesarias
- Instrucciones de instalación

Nomenclatura: DBKxxxxyy





## Master Automotriz 2010 Productos Gates \* Características y especificaciones

### DriveAlign® - Tensores automáticos para bandas Micro-V®

Los tensores automáticos DriveAlign® de Gates exceden las especificaciones de equipo original y están disponibles para las principales marcas de autos a nivel mundial.

Los tensores DriveAlign® de Gates le ofrecen:

- Mejoran la vida útil de las Bandas Micro-V® AT
- Aumentan la vida útil de los accesorios
- Reducen costos de mantenimiento
- **Eliminan el ruido de la transmisión**



#### ● ¿Qué es un tensor de bandas?

En el caso de Gates, no solamente es un tensor de bandas, es un tensor **automático** de bandas. Y es un dispositivo que permite aplicar fuerza constante a la banda, haciéndola trabajar a la tensión ideal.

#### ● ¿Cómo funciona?

El tensor funciona de manera óptima solo si se cumplen los siguientes puntos:

- a) Dimensión correcta de la banda.
- b) Poleas bien alineadas.

## Master Automotriz 2010 Productos Gates \* Características y especificaciones

Se recomienda hacer el recambio del tensor al mismo tiempo que las bandas y las poleas, esto con el propósito de mantener en óptimo desempeño todos sus componentes. Gates de México, le ofrece **Kits DriveAlign®** para bandas Micro-V® que incluyen el tensor, la banda MICRO-® AT y poleas.

**1. BASE:** Pieza fija del tensor que se acopla al bloque del motor o a otros accesorios. Los diseños de la base varían algunos componentes.

**2. RESORTE:** Precargado de fábrica, permite darle tensión a la banda .

**3. AMORTIGUADOR:** Permite autolubricar las partes internas del tensor.

**4. BRAZO:** Conecta el resorte con la polea del tensor. Generalmente es una cubierta de aluminio.

**5. SELLO:** Previene la contaminación interna.

**6. POLEA:** Puede ser metálico o termoplástico, acanalado o liso. La superficie de la polea se debe revisar constantemente para eliminar residuos que dañen la banda. El componente más importante de la polea es el balero. Para que una polea funcione correctamente, el balero debe ser lubricado correctamente. La causa más frecuente de la falla de la polea es pérdida de lubricación en los baleros. (No reemplace los baleros en una vieja polea).

**7. CUBREPOLVO:** Proteje al balero contra elementos contaminantes.

**8. TORNILLO:** Conecta a la polea con el brazo del tensor.

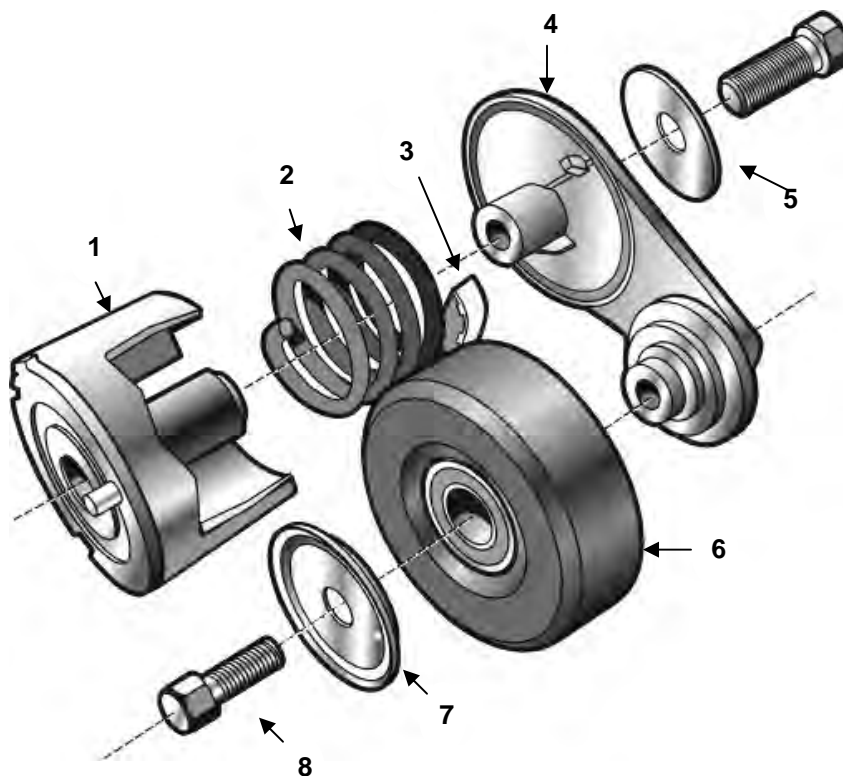

## Tensores automáticos y Poleas para bandas de Tiempo

Los tensores automáticos PowerGrip® de Gates exceden las especificaciones de EQUIPO ORIGINAL y están disponibles para las principales marcas de autos a nivel mundial.

Nuevo

Los tensores PowerGrip® de Gates le ofrecen:

- Mejoran la vida útil de las Bandas Timing
- Reducen costos de mantenimiento
- Eliminan el ruido en la cabina del conductor



## Master Automotriz 2010 Productos Gates \* Características y especificaciones

### Componentes de un tensor PowerGrip – para bandas de TIMING

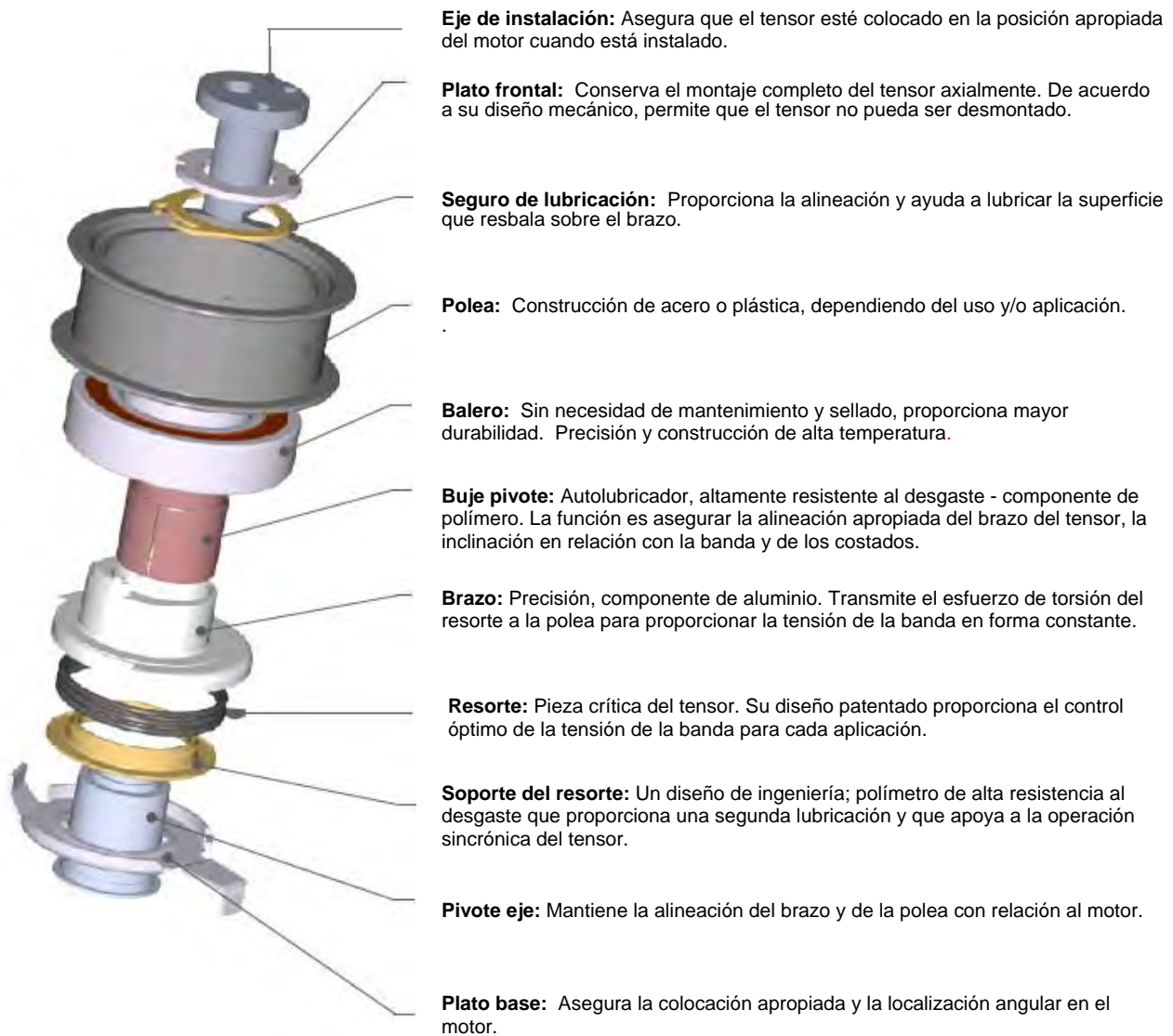

**Nuevo**

## Tensores hidráulicos

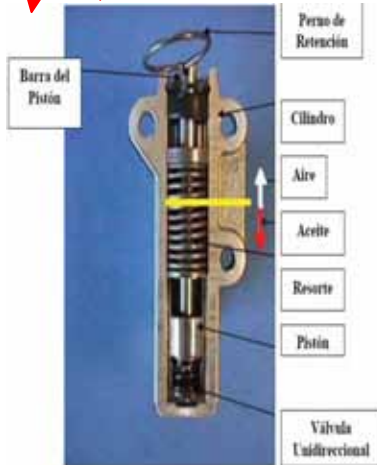

### ¿Qué es?

El sistema hidráulico es usado principalmente en aplicaciones con vibraciones angulares y/o cargas elevadas, en las cuales un tensor mecánico no puede ofrecer el suficiente desplazamiento. En general el tensor hidráulico necesita más espacio en el motor.

El Tensor Hidráulico consiste en un actuador hidráulico en combinación con una polea. El movimiento de la barra del pistón del actuador es transmitido a la polea del tensor mediante una palanca integrada o separada.

### ¿Cómo funciona?

El actuador hidráulico trabaja como un amortiguador de choque, donde un resorte en combinación con el aceite, mantiene la rueda en contacto con el asfalto. En este caso, el actuador hidráulico regula la fuerza dinámica de la banda, a la vez que la mantiene en una tensión constante, y compensa los cambios en longitud debidos a expansión térmica.

La barra del pistón se puede mover fácilmente en una dirección debido al aceite que fluye de un lado del pistón hacia el otro, mediante una válvula unidireccional. Las elevadas cargas dinámicas de la banda se regulan mediante el sistema hidráulico, el cuál empieza a funcionar a partir del momento en el que el aceite es forzado a fluir entre el pistón y el cilindro.

Este sistema hidráulico se optimiza para cada caso, dependiendo del espacio que se deja entre el pistón, el cilindro y de la viscosidad del aceite.

### Almacenamiento:

Los actuadores hidráulicos se deben almacenar verticalmente para evitar el escape de aceite y evitar que se mezcle con el aire. La existencia de burbujas de aire en el aceite podría provocar un mal funcionamiento del sistema.

### Instalación:

El perno de retención sólo debe quitarse después de la instalación de la banda, polea y el actuador.

El motivo de esta recomendación, es que una vez instalado el actuador hidráulico está en una posición vertical, y no hay riesgo de que pueda mezclarse aire en el aceite.

Si el perno se mueve accidentalmente cuando el tensor se encuentra en una posición horizontal, es ALTAMENTE recomendable comprimir la barra del pistón suavemente en posición vertical y posteriormente instalar la pieza. Se deberá dar unas revoluciones manuales al motor con tal de poder separar el aceite y el aire antes de que el motor se encienda.

### Ventajas:

Debido a que el sistema hidráulico ofrece un recorrido mayor que los tensores mecánicos, es particularmente recomendable para motores V6/V8. Sus características los hacen muy apropiado para controlar el comportamiento dinámico de la banda.

### ¿Por qué reemplazarlo?

Desgaste normal del cojinete en la polea del tensor.

Escape de aceite por contaminación en las juntas.



## Master Automotriz 2010 Productos Gates \* Características y especificaciones

### Limpiaparabrisas TRICO

En Gates nos aseguramos que todos nuestros limpiaparabrisas sean ensamblados, diseñados y probados con especificaciones de Equipo Original. Esto nos asegura que los conductores puedan ver apropiadamente en condiciones adversas. La durabilidad y confiabilidad son prioritarias en el diseño de nuestros productos.

El elemento más importante de un limpiaparabrisas es el "hule". Los limpiaparabrisas Trico emplean una fórmula exclusiva y patentada, que lubrica y protege el limpiaparabrisas, gracias a las ceras y aceites que se agregan al hule natural para fortalecerlo y protegerlo del desgaste y condiciones ambientales. Esta es una de las principales ventajas de los limpiaparabrisas fabricados por Trico.

TRICO tiene disponibles las siguientes marcas:

- TRICO METALICO
- ROBERK (Plástico)
- NUVISION (Plástico)
- SUV Especial para camionetas.



**Nuevo**

### Limpiaparabrisas NEOFORM®

Los limpiaparabrisas **NEOFORM** son la línea premier y de más avanzada tecnología en cuanto a limpiaparabrisas se refiere.

Una de las ventajas competitivas más importantes de esta nueva línea es la **infinidad de puntos de presión** que tiene, brindando así, **la mejor visión** gracias a la presión continua y repartida uniformemente que se ejerce sobre toda la superficie del parabrisas.

Su forma aerodinámica evita que se levante por efectos del viento.

Tienen un recubrimiento de Teflón que brinda una limpieza más suave, protegiendo el cristal del parabrisas y dándole mayor tiempo de vida al limpiador.

Los fabricantes de Equipo Original de marcas de lujo dan su preferencia a este tipo de limpiaparabrisas, por lo que las agencias autorizadas son un excelente mercado para la venta de estos productos.

Los limpiaparabrisas **NEOFORM** :

- Empaque Unitario
- Recubrimiento de TEFLON
- Amplia cobertura de Medidas, desde 16" hasta 28"
- Instrucciones de instalación
- Empaque resellable







## Master Automotriz 2010 Productos Gates \* Características y especificaciones

### Limpiaparabrisas Megavision

Los limpiaparabrisas **MEGAVISION** tienen **precios muy competitivos** y su calidad permite una limpieza pareja del parabrisas, **dándole visión y seguridad total**.

Esta nueva línea de limpiaparabrisas tiene las siguientes ventajas:

- Estructura Metálica
- Visibilidad Total
- Buena durabilidad
- Empaque doble, y
- Precio muy competitivo.
- Disponible de 11" y hasta 24"



### Ensamblajes de Dirección Hidráulica

Especialmente diseñados para asistir al Sistema de Dirección Hidráulica, todos están manufacturados para igualar a los de Equipo Original en calidad y apariencia.

Nuestra línea de Ensamblajes de Dirección Hidráulica es la mejor por:

- **Sistema de Doble crimpado:** Evita fugas y el desprendimiento de la manguera.
- **Tubos y terminales recubiertas con zinc:** Evita la corrosión y prolonga su tiempo de vida.
- **Accesorios:** Tienen los mismos accesorios que los de Equipo Original.
- **Soportes para montaje:** Para alinear el ensamble en la posición adecuada y mantenerlo estable.



### Bombas de Dirección Hidráulica

El complemento perfecto para los ensambles de Dirección Hidráulica, haciendo 100% eficiente el Sistema de Dirección de los vehículos.

Las bombas tienen la ventaja de:

- Se prueba el 100% de las bombas antes de salir de la planta.
- Amplia cobertura de aplicaciones.
- Apoyo técnico en caso de ser requerido.





## Master Automotriz 2010 Productos Gates \* Características y especificaciones

### Abrazaderas Sin Fin

Para unir dos componentes o más obteniendo un sistema fijo y seguro de transmisión de fluidos. Nuestras abrazaderas Sin Fin están disponibles en sus dos líneas Gates y Silver line.

Las abrazaderas Gates tienen las siguientes características:

- Material Acero Inoxidable 201 y 301.
- Ancho de banda de  $\frac{1}{2}$ " (13 mm).
- La caja o carcasa, es una sola pieza.
- Tornillo de acero al carbón con recubrimiento de zinc y dicromato de potasio.

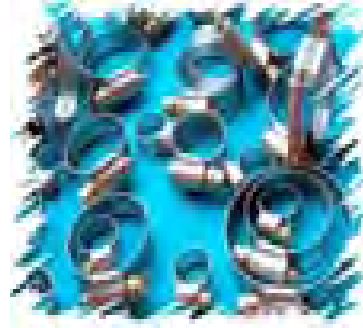

### Abrazaderas de Servicio Pesado

Recomendada para usarse con Mangueras de silicón de turbocargador, líneas de entradas de aire, mangueras de agua, bolsas de filtros, mangueras de bombas de agua, mangueras de sistemas de irrigación, etc.

Las abrazaderas Gates tienen las siguientes características:

- Material Acero Inoxidable 201 y 301.
- Ancho de banda de  $\frac{3}{4}$ ".
- Tornillo y resorte de acero al carbón con recubrimiento de zinc y dicromato de potasio.



### Termostatos Automotrices

Un termostato es una válvula que regula la temperatura de operación de un vehículo, controlando el flujo de refrigerante que va hacia el radiador o regresándolo hacia la bomba de agua, dependiendo de la temperatura.

Nuestra línea automotriz es 25% más eficiente gracias al diseño de su componente térmico ELAC®, que se traduce en:

- Menor consumo de combustible.
- Calentamiento rápido del motor.
- Prolonga la vida del motor.
- Reducción de emisiones contaminantes.





## Termostatos de Servicio Pesado

Especialmente diseñados para los motores y las temperaturas de las unidades de Servicio Pesado.

Los termostatos **WeirStat®**, son un **excelente** sistema de control de temperatura, gracias a su flujo controlado de refrigerante, necesario para los motores especiales de los tractocamiones y autobuses.



## Destelladores (Flashers)

Los destelladores TRIDON sirven para mantener el control de las luces intermitentes, luces direccionales y exteriores del vehículo. No pueden faltar en vehículos con mayor carga de lámparas que las normales.

Su construcción es:

- Cubierta: Plástico transparente que soporta altas temperaturas.
- Dispositivo: electromecánico, utilizando la misma energía eléctrica del vehículo.
- Terminales: Dos y tres terminales de latón para tener mejor conductividad.



# Master Automotriz 2010

## Productos Gates \* Características y especificaciones

### Tapones

Por eso son los preferidos por los fabricantes de autos desde hace más de 18 años.

#### Tapones de Gasolina:

- Compatibles con los sistemas **OBD**.
- Sus válvulas de presión y/o de vacío controlan las emisiones contaminantes.
- **Ahorran hasta un tanque de gasolina al año.**
- Son altamente **resistentes a impactos** y proporcionan la **seguridad** necesaria **en caso de accidentes.**



#### Tapones de Radiador:

- El diseño de todos los tapones es de **Equipo Original**.
- El **100%** de los tapones de radiador **son probados**.
- **No hay fugas de presión**, gracias al **sello de Nitrilo**.
- Altamente **resistentes a la corrosión** gracias a su recubrimiento especial.



#### Tapones de Aceite:

Elemento de seguridad para evitar la contaminación hacia el depósito del aceite y la emisión de sus vapores hacia la atmósfera.



### Tapones para Radiador y Gasolina

## A Prueba de Fugas



**Tapones para Radiador**  
Los tapones para radiador de Gates mantienen una presión constante del sistema de enfriamiento gracias a los sellos desarrollados por la tecnología Gates. Las pruebas realizadas muestran:

Gates	Quim. TP	Thor	LCL
Falso	Falso	Falso	No cumple con especificaciones SAE

**Prueba de las Válvulas**  
El propósito de esta prueba es medir las fugas de líquido y vapor y verificar si el tapón cumple con todos los estándares aplicables de control de emisiones, seguridad e impacto ambiental. Los resultados son los siguientes:

	Gates		Thor		LCL	
	Metal	Plástico	Metal	Plástico	Metal	Plástico
Presión	OK	OK	Falso	Falso	Falso	Falso
Vacío	OK	OK	Falso	Falso	Falso	Falso

Las pruebas de las válvulas son sumamente importantes ya que si los tapones están fuera de los estándares de la norma SAE, los fugas de combustible por evaporación, pueden llegar a representar hasta un tanque de gasolina al año.

**Tapones para Gasolina**  
Los tapones para gasolina de Gates están equipados con válvulas de presión y vacío para controlar las emisiones contaminantes regulando su salida y cumpliendo con los estándares de la Norma Federal IM-240 de los Estados Unidos de Norteamérica.





## Gates continúa marcando el camino en Innovación y solución de problemas



Gates se ha mantenido en la cima en Innovación y solución de problemas, poniendo a nuestros clientes en clara ventaja sobre la competencia.

A mediados de los 80's, la mayoría de los problemas de las mangueras de enfriamiento, se atribuían al calor, al refuerzo y a las bajas temperaturas. Los Ingenieros de Gates descubrieron que la mayoría de estos problemas son el resultado del ataque electroquímico sobre el tubo de la manguera. Diferentes tipos de metales en el sistema de refrigeración, por ejemplo un bloque de hierro fundido, un calentador de aluminio y un núcleo central de cobre del radiador, generan una carga eléctrica. Esta carga se transmite entre los metales y el refrigerante dentro de la manguera. Debido a esta carga generada, diminutas grietas aparecen en tubo de la manguera. El refrigerante se filtra a través de estas grietas, penetra el refuerzo y termina por romper la cubierta. Gates denomina esta causa y efecto Degradación Electroquímica

Gates desarrolló un nuevo compuesto de hule que evita esta falla y lo podrá distinguir mediante las siglas ECR en las etiquetas de nuestras mangueras. ECR significa mayor tiempo de vida útil y un servicio más confiable.

## Mangueras de Enfriamiento



### Mangueras Curvas

Mangueras moldeadas para satisfacer aplicaciones específicas. Idénticas a las de Equipo Original. Aprobadas para aplicaciones marinas.

- Recomendado para el sistema de enfriamiento: superior, inferior, by-pass, calefacción y otras aplicaciones.
- Cubierta resistente al calor y al ozono.
- Diseñado para resistir la degradación electroquímica - principal falla de una manguera de enfriamiento.
- Materiales rediseñados para resistir vacío. Esto reduce la necesidad de resortes internos
- Cumple con SAE 20R4 y 20R3 Tipo CE Clase D-1 y D-2
- Rango de Temperatura: -40°C a 135°C

PRECAUCIÓN: No utilizar para transferir combustible o aceite

**RECOMENDACIÓN:** Siempre reemplace el juego de mangueras: superior e inferior, esto garantizará el óptimo desempeño del sistema de enfriamiento

### Nomenclatura CH nacionales:

Las letras "CH" indican que se trata de una manguera curva

Las siguientes 2 cifras indican la armadora, de la siguiente manera:

- 10 Agromack
  - 11 Chrysler, Dodge, Jeep
  - 12 DINA
  - 13 Ford, Lincoln, Mercury
  - 14 General Motors
  - 17 Mercedes Benz
  - 18 Nissan
  - 20 Renault
  - 21 VAM
  - 22 Volkswagen
- Las siguientes 3 cifras indican un consecutivo pro armadora mismo que se debe llevar en un registro.
  - 
  - La última cifra indica la posición de la manguera en el vehículo.
    - 1 Superior
    - 2 Inferior
    - 3 Paso
    - 4 Calefacción
    - 5 Superior, inferior
    - 6 Gasolina
    - 7 Drenado
    - 8 Frenos



**Master Automotriz 2010**  
**Productos Gates \* Características y especificaciones**

# Mangueras de Enfriamiento (Cont.)

Ejemplos de nomenclatura

EJEMPLO 1

EJEMPLO 2

- Número: CH-135671
  - Línea: Manguera curva (**CH-135671**)
  - Armadora: Ford (**CH-135671**)
  - Consecutivo: De Ford (**CH-135671**)
  - Posición: Superior (**CH-135671**)
- Número: CH-142562
  - Línea: Manguera curva (**CH-142562**)
  - Armadora: General Motors (**CH-142562**)
  - Consecutivo: De Gen. Motors (**CH-142562**)
  - Posición: Inferior (**CH-142562**)

**Tabla de Intercambio**

GATES	TPY	GATES	TPY	GATES	TPY	GATES	TPY
CH-110021	521253	CH-117592	521222	CH-135381	521129	CH-144895	521348
CH-110031	521248	CH-118251	521216	CH-135382	521130	CH-145633	521307
CH-110081	521273	CH-118252	521217	CH-135455	521131	CH-146572	521330
CH-110301	521234	CH-119252	521257	CH-135581	521132	CH-147011	521323
CH-110312	521233	CH-119372	521256	CH-135713	521134	CH-147151	521322
CH-110462	521147	CH-119391	521259	CH-136382	521150	CH-147162	521317
CH-110651	521202	CH-120035	521701	CH-136623	521113	CH-147211	521315
CH-110861	521204	CH-120692	521703	CH-136752	521103	CH-147222	521312
CH-111001	521220	CH-121022	521702	CH-137025	521145	CH-147282	521345
CH-111031	521209	CH-121033	521704	CH-137501	521109	CH-147571	521309
CH-111081	521221	CH-121081	521717	CH-137502	521110	CH-148271	521313
CH-111101	521802	CH-122011	521711	CH-137581	521116	CH-148282	521382
CH-111111	521230	CH-122431	521712	CH-138231	521119	CH-148572	521326
CH-111122	521803	CH-122442	521713	CH-138381	521120	CH-170001	521903
CH-111131	521801	CH-130041	521194	CH-138384	521149	CH-170005	521902
CH-111142	521215	CH-130052	521195	CH-138392	521124	CH-170011	521901
CH-111151	521213	CH-130093	521114	CH-139002	521141	CH-180001	521408
CH-111161	521205	CH-130102	521117	CH-140072	521379	CH-180003	521424
CH-111171	521216	CH-130132	521196	CH-140121	521347	CH-180004	521402
CH-111173	521255	CH-130142	521197	CH-140451	521342	CH-180011	521416
CH-111182	521203	CH-130231	521127	CH-140471	521344	CH-180021	521414
CH-111191	521208	CH-130234	521136	CH-140482	521343	CH-180031	521438
CH-111204	521254	CH-130521	521121	CH-140491	521380	CH-180042	521439
CH-111232	521206	CH-131001	521102	CH-140511	521334	CH-180051	521446
CH-111254	521210	CH-131012	521139	CH-141002	521310	CH-180062	521435
CH-111274	521258	CH-131021	521104	CH-141021	521332	CH-180162	521417
CH-111282	521212	CH-131032	521106	CH-141022	521311	CH-180164	521432
CH-111301	521218	CH-131043	521101	CH-141041	521339	CH-181001	521404
CH-111302	521207	CH-131052	521172	CH-141051	521336	CH-181011	521406
CH-111311	521225	CH-131061	521126	CH-141061	521329	CH-181022	521405
CH-111322	521224	CH-131082	521146	CH-141073	521316	CH-181031	521403
CH-111332	521217	CH-131112	521105	CH-141081	521314	CH-181101	521412
CH-111592	521241	CH-131122	521125	CH-141091	521303	CH-181111	521411
CH-111593	521246	CH-131151	521111	CH-141102	521327	CH-181112	521410
CH-114141	521214	CH-131162	521108	CH-141112	521304	CH-181122	521407
CH-114591	521240	CH-131171	521112	CH-141142	521328	CH-181134	521421
CH-114592	521244	CH-131182	521115	CH-141161	521302	CH-181144	521418
CH-115591	521243	CH-131203	521107	CH-141172	521320	CH-181164	521428
CH-116092	521219	CH-131204	521133	CH-141221	521318	CH-181174	521431
CH-116201	521260	CH-131213	521140	CH-141232	521325	CH-181194	521422
CH-116391	521236	CH-131223	521144	CH-141241	521306	CH-181196	521429
CH-116392	521242	CH-131234	521135	CH-141252	521305	CH-181222	521413
CH-116591	521226	CH-131281	521123	CH-141281	521319	CH-181414	521433
CH-116592	521227	CH-131282	521148	CH-141291	521324	CH-185351	521409
CH-116933	521201	CH-131381	521118	CH-141322	521330	CH-186241	521416
CH-117491	521211	CH-131913	521143	CH-141571	521335	CH-187842	521401



**Master Automotriz 2010**  
**Productos Gates \* Características y especificaciones**

# Mangueras de Enfriamiento (Cont.)

**Tabla de Intercambio (Cont.)**

GATES	TPY	GATES	TPY	GATES	TPY	GATES	TPY
CH-188162	521415	CH-221063	521002	21596	521169	22179	521181
CH-188163	521442	CH-221073	521029	21717	521363	22180	521182
CH-189164	521434	CH-221083	521007	21736	521156	22184	521447
CH-189201	521430	CH-221093	521008	21752	521367	22196	521362
CH-189202	521440	CH-221241	521012	21837	521445	22212	521267
CH-189521	521441	CH-221252	521011	21897	521175	22225	521268
CH-201001	521502	CH-221261	521014	21922	521176	22227	521261
CH-201012	521506	CH-221262	521013	21927	521177	22228	521373
CH-201031	521503	CH-221271	521016	21955	521252	22239	521183
CH-201042	521501	CH-221272	521015	21956	521237	22242	521163
CH-201171	521511	CH-227181	521034	21960	521178	22279	521041
CH-201221	521508	CH-227182	521049	21991	521368	22297	521184
CH-201251	521505	CH-228181	521020	21994	521369	22298	521185
CH-210001	521601	CH-228182	521021	21996	521263	22299	521186
CH-211052	521602	CH-228532	521006	21997	521264	22301	521187
CH-211062	521603	CH-229181	521018	22000	521235	22310	521198
CH-220001	521023	CH-229182	521019	22001	521238	22314	521188
CH-220002	521022	CH-229183	521017	22002	521249	22317	521199
CH-220003	521009	CH-135501	521132	22006	521247	22318	5211100
CH-220034	521024	18733	521040	22037	521370	22332	521374
CH-220054	521025	19025	521358	22039	521361	22340	522002
CH-220064	521026	20230	521167	22058	521371	22341	522003
CH-220073	521027	20355	521164	22087	521372	22343	521375
CH-220083	521036	20470	521138	22120	521232	22346	521189
CH-220333	521035	20475	521165	22121	521250	22347	521190
CH-220371	521037	20511	521173	22122	521179	22351	5211101
CH-220523	521038	20823	521166	22126	521228	22357	521376
CH-220532	521039	20850	521239	22127	521229	22358	521381
CH-220551	521032	20893	521262	22128	521265	22362	521377
CH-220593	521043	20900	521170	22129	521266	22366	5211102
CH-220663	521033	20941	521171	22144	521157	22367	521191
CH-220711	521044	21026	521152	22148	521346	22388	5211103
CH-220741	521045	21145	521153	22152	521359	22392	521192
CH-220751	521046	21281	521366	22155	521158	22419	521269
CH-220762	521047	21329	521245	22156	521159	22426	521378
CH-221001	521005	21353	521443	22157	521160	22443	521270
CH-221003	521010	21356	521444	22162	522004	22460	521271
CH-221023	521003	21514	521154	22163	522001	22467	521272
CH-221033	521004	21532	521155	22178	521180	22474	521042
CH-221054	521001					22505	521193

## Mangueras de Enfriamiento (Cont.)

### Mangueras Twister

Diseñada para reemplazar mangueras de enfriamiento rectas o curvas. Uno de sus beneficios es su cobertura, pues con un mínimo de inventario se cubre un gran número de aplicaciones.

- Excelente flexibilidad, sin riesgo de colapso y/o torsión
- Refuerzo de Rayón de alta tenacidad y alambre helicoidal galvanizado
- Tubo y cubierta de EPDM, de gran resistencia al calor, prolongando la vida útil de la manguera
- Cumple SAE 20R5 Tipo CE Clase D-2

Rango de temperaturas: -40°C hasta +125 ° C)

Presión máxima de 40 psi.

PRECAUCIÓN: No utilizar para transferir combustible o aceite



### Nomenclatura

Los primeros dos dígitos indican el D.I. de la manguera en ambas terminales, en caso de tener diámetros diferentes, el segundo diámetro es indicado mediante un tercer y hasta un cuarto dígito antes de la T.

12: 1 ¼", 15: 1 ½" 17: 1 ¾" 2: 2" 22: 2 ¼" 25: 2 ½" 27: 2 ¾"  
30: 3"

T: Manguera Twister

Los últimos tres dígitos indican la longitud en décimos de pulgada

**12T150**

**12 : Tiene 2 dígitos, por tanto es de diámetros iguales D.I. de 1 1/4"**

**T : Manguera Twister**

**150 : 15.0" de Longitud**

**172T145**

**172 : Tiene 3 dígitos, por tanto es de**

**Iguales diferentes: D1: 17=1 3/4" D2: 2= 2"**

**T : Manguera Twister**

**145 : 14.5" de Longitud**



## Mangueras de Enfriamiento (Cont.)



TWISTER®	Ø	Ø	Longitud	Presión (psi)	Equivalente TPY
1215T135	1 ¼	1 ½	13 ½	46	50008
1215T195	1 ¼	1 ½	19 ½	46	50005
1517T160	1 ½	1 ¾	16	54	50001
1517T200	1 ½	1 ¾	20	54	50012
1517T225	1 ½	1 ¾	22 ½	54	50015
172T145	1 ¾	2	14 ½	63	50010
172T165	1 ¾	2	16 ½	63	50004
172T240	1 ¾	2	24	63	50014

TWISTER®	φ	longitud	Presión (psi)	Equivalente TPY
12T150	1 ¼	15	46	50303
12T172	1 ¼	17 ¼	46	50305
12T202	1 ¼	20 ¼	46	50306
12T232	1 ¼	23 ¼	46	N / D
15T140	1 ½	14	54	50404
15T155	1 ½	15 ½	54	50405
15T170	1 ½	17	54	50406
15T185	1 ½	18 ½	54	N / D
15T200	1 ½	20	54	50407
15T222	1 ½	22 ¼	54	50422
15T250	1 ½	25	54	50408
15T260	1 ½	26	54	50409
15T300	1 ½	30	54	50430
15T350	1 ½	35	54	50435
17T155	1 ¾	15 ½	63	50505
17T165	1 ¾	16 ½	63	N / D
17T175	1 ¾	17 ½	63	50506
17T190	1 ¾	19	63	50508
17T235	1 ¾	23 ½	63	50507
2T155	2	15 ½	73	50602
2T170	2	17	73	50608
2T200	2	20	73	50603
2T240	2	24	73	50604
2T260	2	26	73	50609
22T170	2 ¼	17	81	50703
22T220	2 ¼	22	81	50704



## Mangueras de Combustible

### Manguera FLH



Es la manguera más utilizada como línea de combustible para motores a gasolina

- Tubo de Nitrilo resistente a los combustibles
- Cubierta resistente a derivados del petróleo, el calor, el ozono y a la abrasión.
- Cumple con la norma SAE 30R2.
- NOTA: No sumergirse en gasolina.
- Rango de Temperatura: -20°C a 93°C

Número	Diámetro interior (pulg.)	Presión de trabajo (psi)	Presión de ruptura (psi)	Presentación mini metros	Presentación madera metros
2FLH	1/8	50	700	35	325
3FLH	3/16	150	700	25	250
4FLH	1/4	125	700	20	200
5FLH	5/16	150	700	14	200
6FLH	3/8	115	700	14	120

### Manguera FLC



Diseñada para la conducción de gasolina, diesel o aceite a presión moderada que requiere un refuerzo adicional

- Cubierta de textil tratado químicamente para darle una mayor resistencia al ambiente (humedad, calor, etc)
- NOTA: No sumergirse en gasolina.
- Rango de Temperatura: -20°C a 93°C
- Presión de trabajo de 200 psi en todos sus tamaños

Número	Diámetro interior (pulg.)	Presión de trabajo (psi)	Presión de ruptura (psi)	Presentación mini (metros)	Presentación madera (metros)
2FLC	1/8	200	700	35	120
3FLC	3/16	200	700	25	151
4FLC	1/4	200	700	20	131
5FLC	5/16	200	700	20	137
6FLC	3/8	200	700	15	145

## Mangueras de Combustible (Cont.)

### Manguera MPI / Fuel Injection

Es la manguera Premium para la conducción de combustible, incluyendo sistemas de inyección.

Se puede utilizar en gasolinas con plomo y sin plomo, diesel, biocombustibles a base etanol/ metanol, éteres con concentraciones no mayores a las permitidas por EPA

- Tubo interno de Fluorelastómero resistente a los combustibles, al calor y a la permeación.
- Refuerzo de poliéster trenzado, dando una mayor resistencia.
- Cubierta resistente a derivados del petróleo, el calor, el ozono y a la abrasión.
- Cumple con la norma SAE 30R9.
- NOTA: No sumergirse en gasolina.
- Temperatura máxima de 150°C



NÚMERO DE PARTE (3.05 mts)	NÚMERO DE PARTE (7.62 mts)	DIAMETRO INTERIOR (plg)	PRESION DE TRABAJO (psi)
27082	27094	1 / 4	180
27085	27095	5 / 16	180
27088	27096	3 / 8	180

### Manguera Sumergible

Las mangueras convencionales de combustible, son resistentes únicamente para tener contacto con el tubo de la manguera. La manguera sumergible de Gates, supera la calificación y es resistente a la gasolina, el alcohol o el diesel

tanto en el tubo como en la cubierta, por lo que puede sumergirse en cualquiera de estos combustibles sin ningún riesgo de degradación, lo que provocaría taponamientos en la bomba de combustible

- Diseñado para un contacto permanente con la gasolina (y otros combustibles) en el interior y el exterior.
- Excelente para uso en bombas de combustible en el tanque de gasolina
- Cumple con la norma SAE 30R10
- Tubo de Fluoroelastómero (FKM) resistente a permeación y retarda el envejecimiento.
- Refuerzo de Aramida, la misma fibra utilizada en los chalecos antibalas

CÓDIGO	DESCRIPCIÓN	PRESION DE TRABAJO (psi)	LONGITUD
42195184	27093 5/16 SUBMERSIBLE FUEL	100	1 pie
42196184	27097 3/8" SUBMERSIBLE FUEL	100	1 pie

## Mangueras de Combustible (Cont.)

### Manguera Fuel Fill

Manguera flexible diseñada para el llenado del tanque de combustible. Se puede utilizar tanto en servicio automotriz como en servicio pesado.

Compatible con la mayoría de los tipos de combustibles, especialmente resistente a la gasolina y el diesel.



- Tubo de nitrilo resistente a gasolina, mezclas de etanol, metanol y éteres hasta concentraciones máximas permitidas por la EPA
- Cubierta corrugada con refuerzo de alambre helicoidal.
- Cumple con la norma SAE 30R5.
- Se corta fácilmente con cuchillo y cortadoras de alambre.
- 20 psi de Presión de Trabajo en todos los tamaños
- Rango de temperatura: -40°C a 100°C

CÓDIGO	DESCRIPCIÓN
46633601	23924 1-1/2" X3FT FUEL FILL
46633603	23930 1-7/8" X3FT FUEL FILL
46633604	23932 FUEL FILL HOSE *
46633605	23936 2-1/4" X3FT FUEL FILL
46633606	23940 2-1/2" X3FT FUEL FILL

### Manguera Filler Neck

Manguera recta diseñada para el llenado del tanque de combustible.

• Tubo de nitrilo resistente a gasolina, mezclas de etanol, metanol y éteres hasta concentraciones máximas permitidas por la EPA



- Cubierta lisa
- Cumple con la norma SAE 30R6.
- 20 psi de Presión de Trabajo en todos los tamaños
- Rango de temperatura: -40°C a 100°C

CÓDIGO	DESCRIPCIÓN
42710030	23964 1 1/2"
42710035	23968 1 3/4"
42710045	23972 2"
42710055	23976 2 1/4"
42710065	23980 2 1/2"

## Mangueras de Calefacción



## Master Automotriz 2010 Productos Gates \* Características y especificaciones

### Manguera 30T

Recomendada para usarse en el sistema de calefacción y/o enfriamiento. Reforzada con una capa de textil tejido, que le da mayor resistencia a la presión, hasta 175 psi y mayor flexibilidad en radios menores  
Temperatura máxima de 125°C  
Tubo y cubierta de EPDM, evitando la penetración de aceites y grasas.  
Diámetros disponibles 5/8" y 3/4"



## Manguera de limpiaparabrisas

### Manguera 4106

Diseñada para la conducción de agua o líquido limpiador de cristales, desde el depósito hasta los limpiadores.

- Tubo de EPDM extruído, apropiado para conducir agua y soluciones ligeras
- Cubierta lisa de EPDM, brindando mayor resistencia al medio ambiente
- Presentación: minicarrete de 3/16" D.I. X 30 metros aprox.

## Unicoil

Ahora sus clientes pueden hacer sus propias mangueras curvas, utilizando 30T, 35B ó manguera de calefacción y el nuevo patentado Unicoil™

Unicoil es perfecto para sustituir mangueras de motores adaptados, así como para resolver problemas de ruteo.

- No se necesitan herramientas o equipos especiales
- Ideal para mangueras de modificados o adaptados
- Evita el colapsamiento de las mangueras que son sometidas a dobleces pronunciados
- Solución perfecta cuando la manguera moldeada no está disponible
- Puede ser adquirido de forma individual o en una caja de 12 con display incluido

Disponible en: 1/4", 5/16", 3/8", 1/2", 3/4", 5/8" y 1"



## Unicoil (Cont.)

Exhibidor



Caja

CÓDIGO	DESCRIPCIÓN	PRESENTACIÓN
73162000	28510 Unicoil 1/2"	Caja con 12 pzas
73162001	28511 Unicoil 5/8"	Caja con 12 pzas
73162002	28512 Unicoil 3/4"	Caja con 12 pzas
73162003	28513 Exhibidor	Exhibidor con 12 pzas: 3 de 1/2", 6 de 5/8" y 3 de 3/4"
73162005	28514 Unicoil 1/4"	Caja con 12 pzas
73162006	28515 Unicoil 5/16"	Caja con 12 pzas
73162007	28516 Unicoil 3/8"	Caja con 12 pzas
73162008	28517 Unicoil 1"	Caja con 6 pzas
73162004	28518 Exhibidor	Exhibidor con 18 cajas: 6 de 1/4", 6 de 5/16" y 6 de 3/8"

## Reductores de Diámetro

Son adaptadores que se deslizan fácilmente dentro de las mangueras Gates para reducir el diámetro interior.

- Gran cobertura de Diámetros con un mínimo de inventario de mangueras
- Capacidad de ajustar el D.I. de una manguera mayor en reemplazos de emergencia



CÓDIGO	DESCRIPCIÓN	MEDIDAS
77369390	26390 HOSE ID REDUCER	1 1/2" a 1 1/4"
77369391	26391 HOSE ID REDUCER	1 3/4" a 1 1/2"
77369392	26392 HOSE ID REDUCER	2" a 1 3/4"
77369393	26393 HOSE ID REDUCER	2 1/4" a 2"
77369394	26394 HOSE ID REDUCER	2 1/2" a 2 1/4"
77369395	26395 HOSE ID REDUCER	3" a 2 1/2"

Precaución: Recomendados exclusivamente para aplicaciones de aire y de enfriamiento

### Bandas y componentes de transmisión:



## Master Automotriz 2010 Productos Gates \* Características y especificaciones

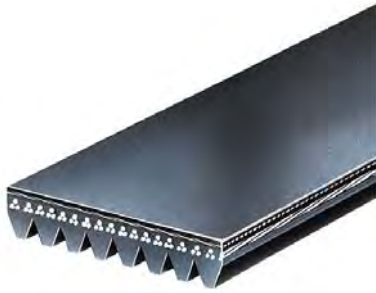

### Bandas Micro-V® AT (Serpentín)

Bandas para serpentín, diseñadas para todas las marcas de automóviles en el mundo. Su diseño especial hace que la banda dure más del doble que su cercano competidor, en aplicaciones problemáticas.

- Silenciosas por su perfil desbastado y alta flexibilidad.
- Mínimo estiramiento por lo que no es necesario re-tensionar.
- Cuerda (refuerzo) de gran resistencia y durabilidad.
- Construido especialmente para resistir desgaste y agrietarse.
- Su diseño especial asegura un control dimensional exacto.
- Exceden las especificaciones de la norma SAE J1459.  
(Tipo de Producto 8552 y 8160).



### Bandas Micro-V® de Doble lado

Para reemplazar las bandas de serpentín de equipo original que requieren un grado más alto de eficacia al transmitir potencia. Diseñadas para las poleas de diámetro pequeños y para el uso con (o sin) los tensores automáticos.

- Pequeñas ranuras en V en ambos lados de la banda.
- Altamente resistente al aceite, al calor y a otras condiciones adversas.
- Amplia cobertura de aplicaciones.
- Exceden los estándares de la Asociación del Fabricante de Hule (RMA por sus siglas en inglés) para la conductividad estática.
- Exceden las especificaciones de la norma SAE J1459.



### TR y XL® bandas en V

La banda más exigente en el Mercado de reemplazo. Su forma trapezoidal con ranuras le permite tener un mejor agarre a las poleas. Esto permite un mejor funcionamiento de la banda, reduciendo su elongación y ruido.

- La acción de su compuesto de hule y su refuerzo, dan mayor flexibilidad a lo largo de toda la banda, ofreciendo una mayor estabilidad en las poleas.
- Cuerdas tensoras con refuerzo de aramida.
- Exceden las especificaciones de la norma SAE J636c.  
(Tipo de producto 8701)



### Bandas Timing para árbol de levas

Diseñadas para altos rangos de velocidad constante y requerimientos de potencia para mover el árbol de levas. Cumple o excede los requerimientos de desempeño de los fabricantes de autos en todo el mundo. Aprobadas para aplicaciones marinas. Gates es el fabricante de estas bandas para las mejores marcas Audi, BMW, Chrysler, Fiat, Ford, GM, Honda, Hyundai, Isuzu, Mazda, Mitsubishi, Nissan, Peugeot, Renault, Subaru, Toyota, Volvo, Volkswagen.

- La más amplia cobertura de aplicaciones en el mercado de reemplazo.
- Resistencia, su cubierta patentada es altamente resistente al calor y al aceite.
- La alta resistencia de sus cuerdas tensoras, minimizan su elongación (estiramiento).  
(Tipo de producto 8595).





## Master Automotriz 2010 Productos Gates \* Características y especificaciones

### Bandas para motonetas y cuatrimotos PowerLink®

Bandas de Velocidad variable, cargas de choque. Diseñadas especialmente para Motonetas, Vehículos Todo Terreno - Cuatrimotor (ATV siglas en inglés) y carros de Golf.

- Bandas de alta flexibilidad que permiten mayor agarre a la polea.
- Reforzado con las fibras de aramida para proporcionar un desempeño óptimo.

NOTA: Utilice las bandas especiales PowerLink® para este tipo de aplicación.  
(Tipo de producto 9817 & 9807).



### Bandas Hi-Power® II

Diseñadas para un alto desempeño, secciones disponibles A,B,C,D y E.

Estas han sido las bandas preferidas del mercado por su perfil único y su excelente fabricación.

- Cubierta Flex-Weave® de alta flexibilidad y excelente resistencia al calor, ozono y aceites.
  - Cuerdas Flex-Bonded de alta capacidad de transmisión de potencia y mínimo estiramiento.
  - Paredes curvas y lomo arqueado para una mejor distribución de la fuerza.
  - Su tipo de construcción Multi-propósitos aplica para varios tipos de vehículos.
  - Cumple con las pruebas de conductividad estática de la RMA (Rubber Manufacturer's Association).
  - V80 programa Gates que garantiza el "Hermanaje" de las bandas (de dimensiones iguales).
- (Tipo de producto 9112 Sec. A – 9113 Sec. B).



### Bandas Tri-Power®

Bandas dentadas para la transmisión de potencia en poleas en V, en maquinaria industrial y vehículos de servicio pesado. Combina las ventajas de las tradicionales bandas Hi-Power con las de las bandas dentadas.

(Tipo de producto 9012 Sec. AX – 9013 Sec. BX).



### Bandas Vulco®

Banda forrada recomendada para transmitir potencia y movimiento en poleas en V. Ideal para los motores de Volkswagen enfriados por aire, como el del Sedán por sus características especiales de tensado de la banda.

(Tipo de producto 8560).



### Bandas PowerBand®

Bandas unidas para transmitir potencia en poleas en V para aplicaciones de servicio pesado donde las bandas individuales se voltean por el alto torque en el momento del arranque o durante la aceleración.

(Tipo de producto 8541 Importadas PB, 9091 Nacional PK).

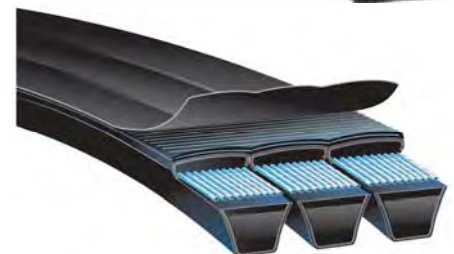

## Herramientas:



### Alineador Láser DriveAlign™

Exclusivo, herramienta patentada compatible con todas las marcas de automóviles para alineación de poleas.

DriveAlign® (No. De Parte 91006)

Identifica rápidamente los dos tipos de desalineación de las poleas más comunes – desalineación angular y horizontal, los cuales reducen la vida de servicio de los componentes y produce ruido en las transmisiones de las bandas. Simplemente con colocar el alineador en las ranuras de la polea y apuntar el láser a la polea opuesta. Cualquier desalineación será visible en un instante.

- Esta herramienta patentada es compatible con todas las transmisiones que utilicen bandas serpentín.
- Ligera y fácil de usar.
- Incluye lentes especiales que amplifican el láser para mejorar la visión en condiciones de baja iluminación.
- Incluye un estuche durable de alto impacto.

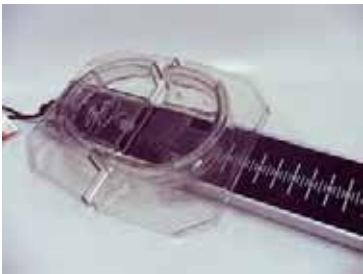

### Medidor Banda Micro-V®

Esta herramienta mide cada banda Micro-V para asistirle en determinar la banda de reemplazo para autos, camionetas, autobuses y camiones de servicio pesado... cuando la banda usada está disponible.

- Se puede medir bandas desde 36" hasta 120". (Cerrado mide solamente 3 pies.)
- Ligero, exacto, y fácil de usar. (No. De Parte 91202)

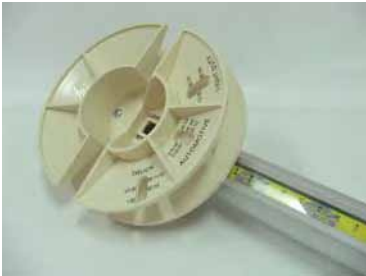

### Localizador Banda-V

Esta herramienta ayuda a identificar el tipo de banda en V que se requiere.

- Identifica el ancho superior de la banda
- Identifica el tipo y longitud de la banda.
- Ligero, exacto y fácil de usar. (No. De Parte 91201)



### Kit Completo para reemplazo de bandas Timing

(No. Part 91007)

Incluye un probador de tensión para bandas Timing.

(no. part 91000), Una herramienta para fijar los engranes del árbol de levas (no. part 91008) y dos Multi-Lock . (no. part 91009).





## Master Automotriz 2010 Productos Gates \* Características y especificaciones

### Krikit II Micro-V® - Medidor de tensión de bandas

(No. Part 91132.)

Diseñado para las bandas Micro-V® en los automóviles, camionetas, Tractocamiones y autobuses.

- Cojín para medir presión y brazo indicador color verde intenso.
- Calibrado para medir la tensión a partir de 100 a 320 libras. y 50 a 150 kilogramos.
- Para hacer mediciones de bandas hasta de 8 costillas de ancho.



### Krikit V-Bandas Medidor de tensión

(Part No. 91107. Charge Item.)

Permite que el usuario tense las bandas durante la instalación, mientras que el motor se encuentre apagado. Esto es importante para un buen funcionamiento de las bandas. Útil para todas las Bandas automotrices en V, se incluyen bandas con anchos superiores a 7/8".

- Incluye instrucciones de uso.
- Lee escalas en libras y kilogramos, a partir de 30 a 160 libras y 15 a 75 kilogramos.
- Cuerpo de aluminio, brazo indicador de nylon y cojín para medir la presión.
- Tiene clip de bolsillo (acero inoxidable).

**NOTA:** No para el uso en bandas TIMING.



### Probador de tensión para bandas Timing

(No. Part 91000)

Proporciona un método exacto para probar la tensión para todas las bandas de sincronización automotriz (Timing).

- El probador de tensión Gates, es útil para cualquier banda Timing hasta 30 mm de ancho.
- Viene con los adaptadores para los diferentes groesores de las bandas.
- Método de aplicación para medir la tensión (desviación de fuerza).
- La escala se puede leer en cualquier posición. Incluye el cupón para el CD-ROM libre de la instalación de la banda dentada.



### Herramienta para tensar las bandas de Serpentin

(No. Part. 91015)

Herramienta ideal para quitar e instalar las bandas de serpiente. Proporciona la fuerza necesaria para desplazar el brazo de la polea tensora.

- El nuevo diseño de 3 barras incluye siete adaptadores (13m m, 14m m, 15m m, 16m m, 18m m, 3/8 " y el 1/2 ").





## Master Automotriz 2010

### Productos Gates \* Características y especificaciones

Use esta sección cuando su cliente llegue con la muestra de producto.

Para las bandas es necesario:

- Medir el ancho.
- Medir la longitud exterior.
- Comparar la sección transversal de la banda.
- Busca la banda que tenga estas dimensiones en el listado.

Para las bandas Timing es necesario:

- Medir el ancho.
- Medir la longitud exterior.
- Comparar el perfil de la banda.
- ESTA BANDA DEBE SER IDENTICA.
- Busca la banda que tenga estas dimensiones en el listado.

Para mangueras curvas es necesario:

- Medir los diámetros de las bocas.
- Medir la longitud media de la manguera.
- Comparar la forma de la manguera.

Para mangueras flexibles.

- Medir los diámetros de las bocas.
- Medir la longitud media de la manguera.
- Busca la manguera que tenga los diámetros iguales a los medidos y una longitud similar en el listado.
- Comprobar que la manguera no chocará con ningún componente del vehículo.

Para ensambles de dirección hidráulica.

- Medir la longitud de la manguera.
- Comparar el tipo de conexiones.
- Comparar las curvas del tubo metálico.
- Buscar la manguera que cumpla con estas características en el listado.

Para termostatos.

- Medir el diámetro de la carcasa.
- Medir el diámetro de la válvula.
- Medir la profundidad de la válvula.
- Medir la altura de la carcasa.
- Buscar un termostato que cumpla con estas características en el listado.

Para tapones de radiador

- Medir el diámetro de la boca.
- Profundidad del tapón.
- Libras de calibración.
- Buscar un tapón que cumpla con estas características en el listado.

Para tapones de gasolina

- Medir el diámetro de la boca.
- ¿Tiene cuerda o no?
- Características de la cuerda.
- ¿Con llave o sin llave?
- Es visible o escondido.
- Buscar el tapón que cumpla con estas características en el listado.

Para tapones de Aceite

- Medir el diámetro de la boca.
- ¿Tiene cuerda o no?
- Características de la cuerda.
- Forma del tapón
- Buscar el tapón que cumpla con estas características en el listado.



**Master Automotriz 2010**  
**Productos Gates \* Características y especificaciones**

# Guía de Poleas DriveAlign®

Listado por número de parte

No. De Parte	Material	Diámetro Exterior	Diámetro del buje	Ancho	Tipo de banda	Superficie de la polea
36026	Acero	70mm	12mm	30mm	6 costillas K	V-Ranurada
T36038	Termoplástico	80mm	8mm	30.3mm	6 costillas K	V-Ranurada
36060	Termoplástico	80mm	24mm*	29mm	3/8 V – SAE 10A	V-Ranurada
36086	Acero	84mm	12mm	25mm	6 costillas K	Lisa
36087	Acero	78mm	12mm	20mm	5 Costillas K	Lisa
36091	Acero	74mm	17mm	39.25mm	10 Costillas K	Lisa
36092	Acero	74mm	17mm	46.25mm	12 Costillas K	Lisa
36093	Acero	72.5mm	17mm	38mm	8 Costillas K	V-Ranurada
36094	Termoplástico	78mm	17mm	32.8mm	8 Costillas K	Lisa
36095	Acero	74mm	17mm	32.8mm	8 Costillas K	Lisa
36096	Acero	86.5mm	17mm	39.4mm	10 Costillas K	Lisa
36097	Acero	119mm	17mm	38mm	8 Costillas K	V-Ranurada
36098	Termoplástico	72mm	17mm	39mm	10 Costillas K	V-Ranurada
36099	Acero	70mm	15mm	20.5mm	4 Costillas K	V-Ranurada
36100	Acero	76mm	17mm	29.5mm	6 Costillas K	V-Ranurada
36101	Acero	70mm	17mm	31mm	6 Costillas K	Lisa
36102	Termoplástico	90mm	17mm	32mm	7 Costillas K	V-Ranurada
36103	Acero	107mm	12mm	32mm	3/8 V – SAE 10A	V-Ranurada
38001	Acero	90mm	17mm	30mm	6 Costillas K	Lisa
38002	Acero	100mm	17mm	30.5mm	6 Costillas K	Lisa
38003	Acero	94.5mm	12mm	16.5mm	3/8 V – SAE 10A	V-Ranurada
38004	Acero	118mm	12mm	16.5mm	3/8 V – SAE 10A	V-Ranurada
38005	Acero	82mm	17mm	30.5mm	6 Costillas K	Lisa
38006	Acero	76mm	17mm	30.5mm	6 Costillas K	Lisa
38007	Termoplástico	90mm	17mm	25.5mm	6 Costillas K	Lisa
38008	Termoplástico	70mm	17mm	34.5mm	6 Costillas K	V-Ranurada
38009	Termoplástico	76mm	17mm	25mm	6 Costillas K	V-Ranurada
38010	Acero	90mm	17mm	27mm	5 Costillas K	Lisa
38011	Acero	82mm	17mm	27mm	5 Costillas K	Lisa
38012	Termoplástico	90mm	17mm	32mm	6 Costillas K	Lisa
38015	Termoplástico	76mm	17mm	25mm	6 Costillas K	Lisa
38016	Termoplástico	76mm	17mm	32mm	7 Costillas K	V-Ranurada
38017	Termoplástico	90mm	17mm	22mm	4 Costillas K	V-Ranurada
38018	Termoplástico	70mm	17mm	25mm	6 Costillas K	Lisa
38019	Termoplástico	90mm	17mm	26.3mm	6 Costillas K	V-Ranurada
38020	Acero	90mm	12mm	30.5mm	6 Costillas K	Lisa
38022	Acero	90mm	17mm	37.5mm	8 Costillas K	Lisa
38023	Termoplástico	76mm	17mm	34mm	8 Costillas K	Lisa
38024	Termoplástico	09mm	17mm	26.3mm	6 Costillas K	V-Ranurada
38025	Termoplástico	52mm	17mm	15mm	3 Costillas K	V-Ranurada
38026	Acero	100mm	17mm	28mm	5 Costillas K	Lisa
38027	Termoplástico	82mm	17mm	25mm	6 Costillas K	Lisa
38028	Acero	76mm	17mm	37mm	8 Costillas K	Lisa
38029	Termoplástico	7mm	17mm	26mm	6 Costillas K	V-Ranurada
38030	Acero	70mm	17mm	20.5mm	4 Costillas K	V-Ranurada
38031	Acero	70mm	12mm	20.5mm	4 Costillas K	V-Ranurada
38032	Termoplástico	76mm	17mm	22mm	5 Costillas K	Lisa
38033	Acero	90mm	17mm	33mm	7 Costillas K	Lisa
38034	Termoplástico	27mm	12mm	29mm	6 Costillas K	V-Ranurada
38035**	Acero	94mm	19mm	19mm	1/2 V – SAE 13A	V-Ranurada



**Master Automotriz 2010**  
**Productos Gates \* Características y especificaciones**

# Guía de Poleas DriveAlign®

Listado por número de parte

No. De Parte	Material	Diámetro Exterior	Diámetro del buje	Ancho	Tipo de banda	Superficie de la polea
38036	Acero	81mm	12mm	17.5mm	1/2 V – SAE 13A	V-Ranurada
38037	Acero	81mm	17mm	18mm	1/2 V – SAE 13A	V-Ranurada
38038	Acero	94mm	17mm	19mm	1/2 V – SAE 13A	V-Ranurada
38039**	Acero	94mm		19mm	1/2 V – SAE 13A	V-Ranurada
38040	Acero	123mm	12mm	18.5mm	1/2 V – SAE 13A	V-Ranurada
38041	Acero	76mm	17mm	30.5mm	6 Costillas K	Lisa
38042	Acero	90mm	10mm	30mm	6 Costillas K	Lisa
38043	Acero	76mm	10mm	30mm	6 Costillas K	Lisa
38044	Acero	80mm	17mm	21.8mm	4 Costillas K	V-Ranurada
38045	Termoplástico	70mm	24mm*	28mm	6 Costillas K	Lisa
38046	Termoplástico	80mm	24mm*	27mm	6 Costillas K	Lisa
38047	Termoplástico	70mm	14.5mm*	31.5mm	6 Costillas K	Lisa
38048	Termoplástico	80mm	14.5mm*	31.5mm	6 Costillas K	Lisa
38049**	Acero	80mm		31mm	6 Costillas K	Lisa
38050**	Acero	76mm		31mm	6 Costillas K	Lisa
38051**	Acero	76mm		25mm	6 Costillas K	Lisa
38052	Acero	90mm	17mm	37mm	8 Costillas K	V-Ranurada
38053	Acero	76mm	17mm	38mm	8 Costillas K	V-Ranurada
38058	Termoplástico	76mm	17mm	29.5mm	7 Costillas K	Lisa
38061**	Termoplástico	75mm	24.5mm*	24.5mm	7 Costillas K	Lisa
38062**	Termoplástico	70mm	24mm*	28mm	7 Costillas K	Lisa
38063**	Termoplástico	70mm	17mm	28mm	7 Costillas K	Lisa
38064**	Termoplástico	70mm	24mm*	28mm	7 Costillas K	Lisa
38065**	Termoplástico	70mm	24mm*	28mm	7 Costillas K	Lisa
38066**	Termoplástico	70mm	24mm*	28mm	7 Costillas K	Lisa
38068**	Acero	60mm	25.7mm*	22.5mm	4 Costillas K	V-Ranurada
38069	Termoplástico	80mm	10.2mm	37mm	6 Costillas K	Lisa
38070	Termoplástico	80mm	8mm	21mm	4 Costillas K	Lisa
38071	Termoplástico	70mm	24.5mm*	24.5mm	6 Costillas K	Lisa
38073	Termoplástico	70mm	24mm*	28mm	7 Costillas K	Lisa
38074	Termoplástico	80mm	12.2mm	25mm	6 Costillas K	Lisa
38075	Acero	75mm	30mm	32.5mm	8 Costillas K	Lisa
38076	Acero	75mm	30mm	40mm	10 Costillas K	Lisa
38077	Termoplástico	80mm	17mm	25mm	5 Costillas K	Lisa
38078	Termoplástico	90mm	24.5mm*	27.5mm	6 Costillas K	Lisa
38079	Termoplástico	90mm	24mm*	27.8mm	6 Costillas K	Lisa
38080	Termoplástico	75mm	24mm*	28.5mm	6 Costillas K	V-Ranurada
38081	Termoplástico	80mm	24mm*	31mm	6 Costillas K	Lisa
38082	Termoplástico	63.5mm	17 mm	26.5mm	6 Costillas K	V-Ranurada
38083	Termoplástico	64mm	8.2mm	23mm	6 Costillas K	V-Ranurada
38084	Termoplástico	80mm	14.5mm*	40mm	8 Costillas K	Lisa
38087	Termoplástico	78mm	9mm	25mm	6 Costillas K	Lisa
38088	Acero	70mm	15mm	18mm	3/8 V – SAE 10A	V-Ranurada
38090	Termoplástico	63.5mm	14.5mm*	31mm	6 Costillas K	V-Ranurada
38091	Termoplástico	64mm	14.5mm*	35.5mm	8 Costillas K	V-Ranurada
38092	Termoplástico	70mm	14.5mm*	31mm	6 Costillas K	V-Ranurada
38093	Termoplástico	85mm	14.5mm*	30mm	6 Costillas K	Lisa

\* Doble borde \*\* Esta parte es un montaje del soporte con la polea y por lo tanto faltan algunos datos de medición.

# Guía de Poleas Decopladoras DriveAlign®

Listado por número de parte

No. De Parte	Material	Diámetro Exterior	Diámetro del buje	Ancho	Tipo de banda	Superficie de la polea
37010P	Acero	50mm	14.5mm	40.5mm	6 Costillas K	V-Ranurada
37011P	Acero	55.5mm	14.5mm	37.5mm	6 Costillas K	V-Ranurada
37012P	Acero	55.5mm	14.5mm	42.5mm	6 Costillas K	V-Ranurada
37013P	Acero	52.5mm	14.5mm	35.5mm	6 Costillas K	V-Ranurada
37014P	Acero	56mm	14.5mm	42.5mm	6 Costillas K	V-Ranurada

## Tipo de Poleas DriveAlign®



**Poleas Metálicas y Termoplásticas**



**Poleas Locas**



**Poleas Decopladoras**

- Dispositivo guía para la banda que actúa con ella al mismo tiempo para transmitir potencia al sistema de accesorios del automóvil.
  - Son aquellas que poseen movimiento libre, es decir, no pertenecen a un componente como bomba de agua, compresor de AA o alternador.
  - Son aquellas que mueven el alternador en conjunto con la banda, sin embargo, la polea tiene un balero especial que le permite rotar libremente en una sola dirección.
- Las poleas Gates se construyen en acero o Nylon, capaces de soportar cargas de choque, altas velocidades (8,000 RPM), carga a la tensión (65,000 lb/pul2), además de ser silenciosas.
  - Son las mejores en el mercado de reemplazo, ya que utilizan lubricantes y sellos que soportan mucho mayor grados de temperaturas, previniendo así el desgaste y fallas.

## POLEA DECOPLADORA



Siempre que el motor se desacelera, por ejemplo, durante un cambio de marcha o apagado del motor, la inercia del alternador crea una resistencia en la banda. La polea decopladora permite que el alternador "se mueva libremente" o se "sobre acelere" cuando la banda, de repente aminora la velocidad. Esto evita que la banda se deslice y reduce la vibración, el desgaste y los rechinidos.

**La polea decopladora DriveAlign® de Gates aumenta el rendimiento y la durabilidad de todos los componentes del sistema de transmisión por bandas para accesorios.**

### Componentes de una polea decopladora DriveAlign®



**Gates recomienda: ¡Si una de estas dos pruebas falla, se debe sustituir inmediatamente la polea decopladora!**

**o 1ª prueba:** Utilice el dedo índice y el pulgar para sujetar el anillo interior (eje) en su sitio. Gire el anillo exterior con la otra mano en la misma dirección que lo haría la banda. Si el anillo exterior se mueve, tiene que sustituir la polea decopladora.

**o 2ª prueba:** Sujete el anillo interno (eje) para que no se mueva. Gire el anillo exterior en la dirección contraria a la banda.





## Master Automotriz 2010

### Productos Gates \* Características y especificaciones

Probablemente note una pequeña resistencia, pero el anillo exterior debería girar suavemente. Si no lo hace, sustituya la polea decopladora.

# Guía de Tensores DriveAlign® y PowerGrip®

## Listado por número de parte

No. Parte	Dimensiones
36026	Acero Polea Ranurada 6 costillas (70mm x 12mm x 26mm)
36079	Para Banda de 6 Costillas - Termoplástico (60mm x 20mm x 25mm)
36091	Acero Poleas/Lisa (74mm x 17mm x 39.25mm)
36092	Acero Poleas/Lisa (74mm x 17mm x 46.25mm)
36093	Acero Ranurada 8 Costillas (74mm x 17mm x 37mm)
36095	Acero Poleas/Lisa (74mm x 17mm x 33mm)
36096	Acero Poleas/Lisa (86.5mm x 17mm x 39.4mm)
36098	Termoplástico Ranurada 10 Costillas (74mm x 17mm x 39mm)
36112	Acero Poleas/Lisa (76.3mm x 17mm x 29.5mm)
36115	Acero Poleas/Lisa (83.5mm x 12mm x 18mm)
36116	Acero Polea/Ranurada (100mm x 17mm x 18.8mm)
36118	Acero Polea/Ranurada (80mm x 17mm x 25mm)
36119	Acero Poleas/Lisa (102mm x 17mm x 26mm)
36136	Acero Polea Ranurada 6 costillas (72mm x 15mm x 26mm)
36137	Acero Polea Lisa (70mm x 15mm x 25mm)
36142	Acero Poleas/Lisa (83.5mm x 17mm x 30mm) - W/12mm Bushing
36152	Acero Poleas/Lisa (70mm x 17mm x 20.5mm)
36156	Termoplástico Poleas/Lisa (70mm x 17mm x 19mm)
36157	Acero Polea Ranurada 6 costillas (87mm x 17mm x 31mm) - Flanged
36157	Acero Polea Ranurada 6 costillas (87mm x 17mm x 31mm) - Flanged
36169	Acero Poleas/Lisa (60mm x 12mm x 21.25mm)
38001	Acero Poleas/Lisa (90mm x 17mm x 30.5mm)
38006	Acero Poleas/Lisa (76mm x 17mm x 30.5mm)
38008	Para Banda de 6 Costillas - Termoplástico (70mm x 17mm x 25mm)
38009	Para Banda de 6 Costillas - Termoplástico (76mm x 17mm x 25mm)
38015	Termoplástico Poleas/Lisa (76mm x 17mm x 25mm)
38022	Acero Poleas/Lisa (90mm x 17mm x 37.5mm)
38023	Termoplástico Poleas/Lisa (76mm x 17mm x 34mm)
38028	Acero Poleas/Lisa (76mm x 17mm x 37mm)
38033	Acero Poleas/Lisa (90mm x 17mm x 33mm)
38049	Acero Poleas/Lisa (80mm x N/A x 31mm)
38053	Acero Ranurada 8 Costillas (76mm x 17mm x 38mm)
38061	Termoplástico Poleas/Lisa (75mm x 24.5mm x 8.2mm x 24.5mm) - C/Perno
38062	Termoplástico Poleas/Lisa (70mm x 27mm x 8.2mm x 28mm)





## Master Automotriz 2010

### Productos Gates \* Características y especificaciones

No. Parte	Dimensiones
38063	Termoplástico Poleas/Lisa (70mm x 17mm x 28mm) - C/Perno
38066	Termoplástico Poleas/Lisa (70mm x 24mm x 8.2mm x 28mm) - C/Perno
38068	Para Banda de 4 Costillas - Acero (60mm x 25.7mm x 10.2mm x 22.5mm)
38075	Acero Poleas/Lisa (75mm x 30mm x 32.5mm)
38076	Acero Poleas/Lisa (75mm x 30mm x 32.5mm)
38092	Para Banda de 6 Costillas - Termoplástico (70mm x 14.5mm x 8mm x 26.5mm)
38099	ND
38101	Para Banda de 6 Costillas - Acero (100mm x 17mm x 30.5mm)
38102	Para Banda de 6 Costillas - Termoplástico (70mm x 17mm x 25mm)
38103	Para Banda de 6 Costillas - Termoplástico (70mm x 17mm x 25mm)
38104	Para Banda de 6 Costillas - Termoplástico (76mm x 17mm x 25mm)
38105	Para Banda de 6 Costillas - Termoplástico (90mm x 17mm x 25.5mm)
38106	Para Banda de 6 Costillas - Termoplástico (76mm x 17mm x 25mm)
38107	Para Banda de 6 Costillas - Acero (90mm x 17mm x 30.5mm)
38108	Para Banda de 6 Costillas - Acero (90mm x 17mm x 30.5mm)
38109	Para Banda de 5 Costillas - Acero (100mm x 17mm x 28mm)
38110	Para Banda de 5 Costillas - Acero (100mm x 17mm x 28mm)
38111	Para Banda de 6 Costillas - Acero (100mm x 17mm x 30.5mm)
38112	Para Banda de 5 Costillas - Acero (90mm x 17mm x 30mm)
38113	Para Banda de 6 Costillas - Acero (90mm x 17mm x 30.5mm)
38114	Para Banda de 6 Costillas - Acero (76mm x 17mm x 30.5mm)
38115	Para Banda de 6 Costillas - Termoplástico (90mm x 17mm x 25.5mm)
38116	Para Banda de 7 Costillas - Termoplástico (76mm x 17mm x 32mm)
38117	Para Banda de 6 Costillas - Acero (76mm x 17mm x 30.5mm)
38118	Para Banda de 6 Costillas - Acero (76mm x 17mm x 30.5mm)
38119	Para Banda de 8 Costillas - Acero (90mm x 17mm x 37.5mm)
38120	Para Banda de 6 Costillas - Acero (82mm x 17mm x 30.5mm)
38121	Para Banda de 6 Costillas - Acero (76mm x 17mm x 30.5mm)
38122	Para Banda de 6 Costillas - Acero (90mm x 17mm x 30.5mm)
38123	Para Banda de 6 Costillas - Acero (76mm x 17mm x 30.5mm)
38124	Para Banda de 6 Costillas - Acero (90mm x 17mm x 30.5mm)
38125	Para Banda de 6 Costillas - Acero (82mm x 17mm x 30.5mm)
38126	Para Banda de 6 Costillas - Acero (82mm x 17mm x 30.5mm)
38127	Para Banda de 6 Costillas - Termoplástico (76mm x 17mm x 25mm)
38128	Para Banda de 6 Costillas - Termoplástico (82mm x 17mm x 25mm)
38129	Para Banda de 6 Costillas - Acero (90mm x 17mm x 30.5mm)
38130	Para Banda de 6 Costillas - Acero (90mm x 17mm x 30.5mm)



**Master Automotriz 2010**  
**Productos Gates \* Características y especificaciones**

## Guía de Tensores DriveAlign® y PowerGrip®

Listado por número de parte

No. Parte	Dimensiones
38131	Para Banda de 6 Costillas - Acero (90mm x 17mm x 37.5mm)
38132	Para Banda de 6 Costillas - Acero (76mm x 17mm x 30.5mm)
38133	Para Banda de 8 Costillas - Termoplástico (76mm x 17mm x 34mm)
38134	Para Banda de 6 Costillas - Acero (100mm x 17mm x 30.5mm)
38135	Para Banda de 4 Costillas - Termoplástico (90mm x 17mm x 22mm)
38136	Para Banda de 6 Costillas - Acero Poleas/Lisa (76mm x 17mm x 30.5mm)
38137	Para Banda de 6 Costillas - Termoplástico (70mm x 17mm x 25mm)
38138	Para Banda de 6 Costillas - Termoplástico (90mm x 17mm x 25.5mm)
38139	Para Banda de 6 Costillas - Termoplástico (76mm x 17mm x 25mm)
38140	Para Banda de 6 Costillas - Termoplástico (90mm x 17mm x 32mm) - C/Bridas
38141	Para Banda de 6 Costillas - Termoplástico (90mm x 17mm x 26.3mm)
38142	Para Banda de 6 Costillas - Acero (90mm x 17mm x 30.5mm)
38143	Para Banda de 6 Costillas - Acero (90mm x 17mm x 37.5mm)
38144	Para Banda de 6 Costillas - Termoplástico (90mm x 17mm x 25.5mm)
38145	Para Banda de 6 Costillas - Acero (90mm x 17mm x 30.5mm)
38146	Para Banda de 5 Costillas - Acero (82mm x 17mm x 27mm)
38147	Sin Polea
38148	Para Banda de 6 Costillas - Termoplástico (70mm x 17mm x 25mm)
38150	Para Banda de 6 Costillas - Termoplástico (70mm x 17mm x 25mm)
38151	Para Banda de 5 Costillas - Acero (76mm x 17mm x 24mm)
38152	Para Banda de 6 Costillas - Termoplástico (76mm x 17mm x 25mm)
38153	Para Banda de 6 Costillas - Acero Poleas/Lisa (76mm x 17mm x 30.5mm)
38155	Para Banda de 6 Costillas - Acero Poleas/Lisa (76mm x 17mm x 31mm) – C/Perno
38156	Para Banda de 5 Costillas - Acero (90mm x 17mm x 30mm)
38157	Para Banda de 6 Costillas - Acero Poleas/Lisa (76.2mm x 10.3mm x 33mm)
38158	Para Banda de 6 Costillas - Termoplástico (76mm x 17mm x 25mm)
38159	Para Banda de 4 Costillas - Acero (60mm x 12mm x 21mm)
38160	Para Banda de 6 Costillas - Acero Ranurada (98mm x 17mm x 27mm)
38161	Acero Poleas/Lisa (100mm x 17mm x 30.5mm)
38162	Para Banda de 6 Costillas - Acero (76mm x 17mm x 30.5mm)
38163	Para Banda de 6 Costillas - Termoplástico (70mm x 17mm x 25mm)
38164	Para Banda de 6 Costillas - Termoplástico (76mm x 17mm x 25mm)
38165	Para Banda de 6 Costillas - Termoplástico (76mm x 17mm x 25mm)
38167	Para Banda de 6 Costillas - Acero (90mm x 17mm x 29.5mm); Termoplástico (76mm x 17mm x 28mm)



## Master Automotriz 2010

### Productos Gates \* Características y especificaciones

No. Parte	Dimensiones
38168	Para Banda de 6 Costillas - Termoplástico (76mm x 17mm x 22mm)
38169	Para Banda de 6 Costillas - Acero (90mm x 17mm x 30.5mm)
38171	Para Banda de 6 Costillas - Acero (90mm x 17mm x 30.5mm)
38172	Para Banda de 6 Costillas - Acero (70mm x 17mm x 24mm)
38173	Acero Poleas/Lisa (102mm x 17mm x 26mm)
38174	Para Banda de 6 Costillas - Termoplástico (90mm x 17mm x 26mm)
38175	Para Banda de 7 Costillas - Termoplástico (62mm x 17mm x 29mm)
38176	Termoplástico Poleas/Lisa (70mm x 17mm x 19mm)
38177	Para Banda de 5 Costillas - Acero (82mm x 17mm x 27mm)
38178	Para Banda de 6 Costillas - Termoplástico (70mm x 17mm x 25mm)
38179	Para Banda de 6 Costillas - Termoplástico (76mm x 17mm x 25mm)
38180	Acero Poleas/Lisa (76mm x 17mm x 31mm)
38181	Acero Poleas/Lisa (76mm x 17mm x 30.5mm)
38182	Acero Poleas/Lisa (76mm x 17mm x 30.5mm)
38185	Acero Poleas/Lisa (70mm x 17mm x 25mm)
38186	Termoplástico Ranurada 6 Costillas (70mm x 17mm x 25mm)
38187	Acero Poleas/Lisa (90mm x 17mm x 30.5mm)
38188	Termoplástico Ranurada 6 Costillas (70mm x 17mm x 25mm)
38189	Acero Poleas/Lisa (76mm x 17mm x 30.5mm)
38190	Termoplástico Poleas/Lisa (70mm x 17mm x 25mm)
38191	Acero Poleas/Lisa (76mm x 17mm x 37mm); Acero Ranurada 8 Costillas (76mm x 17mm x 38mm)
38191	Acero Poleas/Lisa (76mm x 17mm x 37mm); Acero Ranurada 8 Costillas (76mm x 17mm x 38mm)
38192	Acero Poleas/Lisa (70mm x 17mm x 24mm) - C/ Actuador Hidráulico
38193	Para Banda de 6 Costillas - Acero (76mm x 17mm x 25mm)
38194	Para Banda de 6 Costillas - Termoplástico (70mm x 17mm x 25mm)
38195	Termoplástico Ranurada 6 Costillas (70mm x 17mm x 25mm)
38196	Para Banda de 4 Costillas - Termoplástico (65mm x 17mm x 20mm)
38197	Termoplástico Ranurada 3 Costillas (52mm x 17mm x 15mm)
38198	Termoplástico Poleas/Lisa (82mm x 17mm x 25mm)
38200	Para Banda de 6 Costillas - Termoplástico (70mm x 17mm x 25mm)
38201	Termoplástico Poleas/Lisa (70mm x 17mm x 26mm)
38207	Acero Poleas/Lisa (76mm x 17mm x 28mm)
38216	Acero Poleas/Lisa (70mm x 17mm x 32mm) - C/ Actuador Hidráulico
38218	Sin Polea
38219	Sin Polea
38220	Sin Polea
38221	Sin Polea



## Master Automotriz 2010

### Productos Gates \* Características y especificaciones

No. Parte	Dimensiones
38223	Termoplástico Poleas/Lisa (70mm x 17mm x 26.4mm)
38224	Termoplástico Poleas/Lisa (70mm x 17mm x 26mm)
38225	Sin Polea
38226	Termoplástico Poleas/Lisa (90.2mm x 17mm x 22.8mm)
38245	Termoplástico Ranurada 7 Costillas (90mm x 17mm x 32mm)
38246	Acero Poleas/Lisa (90mm x 17mm x 30.5mm)
38247	Termoplástico Poleas/Lisa (76mm x 17mm x 22mm)
38249	Termoplástico Poleas/Lisa (76mm x 17mm x 26mm)
38250	Acero Poleas/Lisa (76mm x 17mm x 30.5mm)
38251	Acero Poleas/Lisa (76mm x 17mm x 30.5mm)
38256	Acero Poleas/Lisa (90mm x 17mm x 33mm)
38257	Acero Poleas/Lisa (76mm x 17mm x 37mm); Acero Ranurada 8 Costillas (76mm x 17mm x 38mm)
38258	Acero Poleas/Lisa (76mm x 17mm x 30.5mm)
38258	Acero Poleas/Lisa (76mm x 17mm x 30.5mm)
38259	Acero Poleas/Lisa (63mm x 17mm x 18mm)
38260	Termoplástico Ranurada 6 Costillas (76mm x 17mm x 25mm)
38261	Acero Poleas/Lisa (76mm x 17mm x 23mm)
38266	Acero Poleas/Lisa (82mm x 17mm x 31mm)
38268	Termoplástico Poleas/Lisa (76mm x 17mm x 26mm)
38269	Termoplástico Poleas/Lisa (76mm x 17mm x 26mm)
38270	Termoplástico Poleas/Lisa (82mm x 17mm x 30mm)
38271	Acero Poleas/Lisa (76mm x 17mm x 31mm)
38273	Acero Poleas/Lisa (70mm x 17mm x 27mm)
38274	Acero Poleas/Lisa (76mm x 17mm x 30.5mm)
38275	Acero Poleas/Lisa (76mm x 17mm x 30.5mm)
38276	Termoplástico Ranurada 3 Costillas (52mm x 8mm x 13mm)
38277	ND
38278	Acero Poleas/Lisa (76.5mm x 17mm x 37.5mm)
38279	Acero Poleas/Lisa (76mm x 17mm x 30.5mm)
38284	Acero Poleas/Lisa (82.5mm x 17mm x 31mm)
38285	Acero Poleas/Lisa (76mm x 39mm)
38286	Termoplástico Poleas/Lisa (70mm x 17mm x 25mm)
38288	Acero Poleas/Lisa (76mm x 17mm x 30.5mm); Acero Poleas/Lisa (76mm x 17mm x 30.5mm)
38289	Termoplástico Poleas/Lisa (76mm x 17mm x 26mm)
38291	Acero Polea Ranurada 6 costillas (76mm x 17mm x 30mm)
38297	Termoplástico Poleas/Lisa (70mm x 17mm x 34mm)
38298	Acero Poleas/Lisa (76mm x 17mm x 37mm)



**Master Automotriz 2010**  
**Productos Gates \* Características y especificaciones**

## Guía de Tensores DriveAlign® y PowerGrip®

Listado por número de parte

38299	Acero Poleas/Lisa (76.2mm x 17mm x 37mm)
38308	Acero Poleas/Lisa (70mm x 17mm x 25mm)
38317	Termoplástico Ranurada 7 Costillas (70mm x 17mm x 29mm)
38322	Acero Poleas/Lisa (85mm x 17mm x 31mm) – C/ Actuador Hidráulico
38323	Termoplástico Poleas/Lisa (70mm x 17mm x 26mm)
38324	Acero Poleas/Lisa (76mm x 17mm x 31.5mm)
38327	Acero Poleas/Lisa (90mm x 17mm x 29mm)
38328	Para Banda de 6 Costillas - Termoplástico (70mm x 17mm x 30mm)
38329	Acero Ranurada 6 Costillas (76mm x 17mm x 30mm) - C/Bridas
38330	Acero Ranurada 8 Costillas (76mm x 17mm x 38mm)
38332	Acero Poleas/Lisa (76.3mm x 17mm x 29.5mm)
38340	Acero Poleas/Lisa (102.5mm x 17mm x 34.5mm)
38341	Acero Poleas/Lisa (76mm x 17mm x 30.5mm)
38350	Termoplástico Ranurada 7 Costillas (76mm x 17mm x 32mm) - Flanged
38351	Acero Poleas/Lisa (76mm x 17mm x 31mm); Termoplástico Ranurada 6 Costillas (76mm x 17mm x 26mm)
38357	Acero Polea Ranurada 6 costillas (70mm x 17mm x 28mm) - Flanged
38358	Acero Poleas/Lisa (70mm x 17mm x 25mm)
38376	Termoplástico Poleas/Lisa (76mm x 17mm x 26mm)
38378	Acero Poleas/Lisa (76mm x 17mm x 36.3mm)
38382	Termoplástico Ranurada 7 Costillas (80mm x 17mm x 32mm)
38383	Termoplástico Ranurada 6 Costillas (76mm x 17mm x 25mm) - C/Bridas
38384	Termoplástico Poleas/Lisa (70mm x 17mm x 25mm)
38397	Acero Poleas/Lisa (70mm x 17mm x 31mm)
38408	Para Banda de 6 Costillas - Termoplástico (70mm x 17mm x 25mm) - Flanged, W/2 Bolts
38409	Para Banda de 6 Costillas - Termoplástico (70mm x 17mm x 25mm) - Flanged, W/2 Bolts
38411	Acero Poleas/Lisa (70mm x 17mm x 33.3mm)
38417	Termoplástico Poleas/Lisa (70mm x 17mm x 24mm)
38418	Acero Poleas/Lisa (70mm x 17mm x 31mm)
38419	Acero Poleas/Lisa (70mm x 17mm x 31mm)
38420	Para Banda de 6 Costillas - Termoplástico (74mm x 17mm x 26mm) - Flanged
38462	Acero Poleas/Lisa (65mm x 17mm x 23mm)
38501	Para Banda de 8 Costillas - Acero (75mm x 30mm x 32.5mm)
38502	Para Banda de 8 Costillas - Acero (75mm x 30mm x 32.5mm)



## Master Automotriz 2010

### Productos Gates \* Características y especificaciones

No. Parte	Dimensiones
38503	Para Banda de 10 Costillas - Acero (75mm x 30mm x 40mm)
38504	Para Banda de 10 Costillas - Acero (75mm x 30mm x 40mm)
38505	Para Banda de 6 Costillas - Termoplástico (70mm x 17mm x 25mm)
38506	Para Banda de 10 Costillas - Acero (75mm x 30mm x 40mm)
38507	Acero Poleas/Lisa (75mm x 30mm x 40mm)
38508	Para Banda de 10 Costillas - Acero (75mm x 30mm x 40mm)
38509	Para Banda de 8 Costillas - Acero (75mm x 30mm x 32.5mm)
38510	Acero Poleas/Lisa (75mm x 30mm x 46.5mm)
38511	Para Banda de 10 Costillas - Acero (75mm x 30mm x 40mm)
38512	Para Banda de 10 Costillas - Acero (75mm x 30mm x 40mm)
38513	Para Banda de 10 Costillas - Acero (75mm x 30mm x 40mm)
38514	Para Banda de 10 Costillas - Acero (75mm x 30mm x 40mm)
38516	Acero Ranurada 8 Costillas (76.8mm x 30mm x 33.3mm)
38517	Acero Poleas/Lisa (75mm x 30mm x 32.5mm)
38519	Acero Poleas/Lisa (75mm x 30mm x 46mm)
38521	Acero Poleas/Lisa (75mm x 30mm x 43mm)
38523	Acero Poleas/Lisa (75mm x 30mm x 40mm)
38524	Acero Poleas/Lisa (75mm x 30mm x 40mm)
38525	Acero Ranurada 8 Costillas (76.8mm x 30mm x 33.3mm)
38527	Acero Ranurada 8 Costillas (76.8mm x 30mm x 33.3mm)
38529	Acero Poleas/Lisa (75mm x 30mm x 46.4mm)
38530	Acero Ranurada 12 Costillas (75mm x 30mm x 47.54mm)
38531	Acero Poleas/Lisa (70mm x 30mm x 37.1mm)
38532	Acero Poleas/Lisa (75mm x 30mm x 32.5mm)
38534	Acero Poleas/Lisa (74mm x 30mm x 46.4mm)
38535	Acero Poleas/Lisa (75mm x 30mm x 46.4mm)
38536	Acero Polea Ranurada 10 costillas (74mm x 30mm x 43mm)
38537	Acero Poleas/Lisa (75mm x 30mm x 46.5mm)
38539	Acero Poleas/Lisa (75mm x 30mm x 46.5mm)
38540	Acero Poleas/Lisa (75mm x 30mm x 40mm) - W/Bolt
38541	Acero Poleas/Lisa (75mm x 30mm x 40mm) - W/Bolt
38545	Para Banda de 6 Costillas - Termoplástico (76mm x 17mm x 25mm)
38547	Acero Poleas/Lisa (75mm x 30mm x 37mm) - W/Bolt
38548	Acero Poleas/Lisa (75mm x 30mm x 32.5mm)
38550	Acero Poleas/Lisa (75mm x 30mm x 40mm)
38556	Acero Poleas/Lisa (86.5mm x 30mm x 40mm)
38557	Acero Poleas/Lisa (75mm x 30mm x 40mm)



## Master Automotriz 2010

### Productos Gates \* Características y especificaciones

No. Parte	Dimensiones
38567	Acero Poleas/Lisa (75mm x 30mm x 32.5mm)
38568	Acero Poleas/Lisa (75mm x 30mm x 32.5mm)
38569	Acero Poleas/Lisa (75mm x 30mm x 32.5mm)
38578	Acero Poleas/Lisa (75mm x 30mm x 40mm)
38579	Acero Poleas/Lisa (86.5mm x 30mm x 40mm)
38581	Acero Polea Ranurada 10 costillas (78mm x 30mm x 38mm) - W/Bolt
38584	Acero Poleas/Lisa (86.5mm x 30mm x 32mm) - W/Bolt
38585	Acero Poleas/Lisa (75mm x 30mm x 40mm)
38586	Acero Poleas/Lisa (75mm x 30mm x 40mm)
38587	Acero Poleas/Lisa (76.3mm x 17mm x 57mm)
38589	Termoplástico Ranurada 6 Costillas (76mm x 17mm x 25mm)
38590	Acero Poleas/Lisa (76mm x 17mm x 46mm)
38597	Acero Poleas/Lisa (75mm x 30mm x 32.5mm)
38598	Acero Poleas/Lisa (75mm x 30mm x 32.5mm)
38599	Termoplástico Ranurada 6 Costillas (76mm x 17mm x 25mm)
38607	Acero Poleas/Lisa (75mm x 30mm x 40mm)
38611	Acero Poleas/Lisa (75mm x 30mm x 46.4mm)
38617	Acero Polea Ranurada 6 costillas (80mm x 30mm x 30mm) - Flanged
38620	Acero Poleas/Lisa (75mm x 30mm x 40mm)
38622	Acero Poleas/Lisa (74mm x 30mm x 43mm)
37008P	Alternator Decoupler Pulleys
37010P	Acero Polea Ranurada 6 costillas (50mm x 14.5mm x 40.5mm)
37012P	Acero Polea Ranurada 6 costillas (55.5mm x 14.5mm x 42.5mm)
37013P	Acero Polea Ranurada 6 costillas (52.5mm x 14.5mm x 35.5mm)
37014P	Acero Polea Ranurada 6 costillas (56mm x 14.5mm x 42.5mm)
T36038	ND
T38415	Acero Poleas/Lisa (70mm x 10mm x 25mm)
T38484	EUR
T41001	Plastica Lisa (72mm x 11mm x 24mm) - Flanged
T41002	Acero Poleas/Lisa (62mm x 10mm x 35mm)
T41005	Steel Cog (47mm x N/A x 30mm)
T41005	Steel Cog (47mm x N/A x 30mm)
T41007	Acero Poleas/Lisa (48mm x 9mm x 32mm) - W/Bolt, Washer, Lock Washer, Nut
T41008	Plastica Lisa (85mm x Slotted x 30mm)
T41011	Acero Poleas/Lisa (57mm x Slotted x 26mm)
T41013	Acero Poleas/Lisa (70mm x Slotted x 19mm)
T41014	Acero Poleas/Lisa (62mm x Slotted x 27mm)





## Master Automotriz 2010

### Productos Gates \* Características y especificaciones

No. Parte	Dimensiones
T41015	Acero Poleas/Lisa (65mm x Slotted x 32mm)
T41016	Acero Poleas/Lisa (55mm x Slotted x 30mm)
T41020	Acero Poleas/Lisa (55mm x Slotted x 24mm)
T41021	Acero Poleas/Lisa (55mm x Slotted x 32mm)
T41022	Acero Poleas/Lisa (70mm x Slotted x 19mm)
T41023	Acero Poleas/Lisa (53mm x Slotted x 26mm)
T41024	Acero Poleas/Lisa (55mm x N/A x 28mm)
T41028	Acero Poleas/Lisa (60mm x 30mm x 36mm) - W/Bushing, Bolt, 2 Washers, Lock Washer
T41031	Acero Poleas/Lisa (52mm x Slotted x 25mm)
T41037	Acero Poleas/Lisa (60mm x N/A x 28.5mm) - C/Bridas
T41038	Acero Poleas/Lisa (55mm x 8.5mm x 18.5mm) - Flanged
T41039	Acero Poleas/Lisa (60mm x 10mm x 35mm)
T41044	Acero Poleas/Lisa (60mm x N/A x 29mm) - Flanged
T41048	Acero Poleas/Lisa (60mm x Slotted x 32mm)
T41054	Acero Poleas/Lisa (60mm x 10mm x 33mm) - Flanged
T41058	Acero Poleas/Lisa (60mm x 8.5mm x 26mm) - C/Bridas
T41059	Acero Poleas/Lisa (60mm x 10mm x 30mm)
T41064	Plastica Lisa (58mm x 8.2mm x 25mm)
T41065	Acero Poleas/Lisa (51mm x 8mm x 28mm)
T41067	Acero Poleas/Lisa (57.5mm x ranurado x 29mm)
T41070	Acero Poleas/Lisa (57.5mm x ranurado x 29mm)
T41075	Acero Poleas/Lisa (62mm x 8.1mm x 36.5mm)
T41078	Acero Poleas/Lisa (62mm x 8.1mm x 36.5mm)
T41079	Acero Poleas/Lisa (72mm x 10.3mm x 25.4mm) - C/Bridas
T41084	Acero Poleas/Lisa (62mm x 10mm x 35mm) - C/Perno
T41085	Acero Poleas/Lisa (60mm x 10mm x 36mm)
T41090	Acero Poleas/Lisa (55mm x 10.1mm x 30mm)
T41098	Acero Poleas/Lisa (62mm x 10mm x 34mm) - W/Bushing, Bolt, Washer
T41107	Acero Poleas/Lisa (71mm x 10.3mm x 30mm) - C/Bridas
T41204	Acero Poleas/Lisa (62mm x 12mm x 40mm) - C/Actuador hidráulico
T41212	Acero Poleas/Lisa (57.5mm x 34mm)
T41228	Acero Poleas/Lisa (58mm x 10.1mm x 36mm) - Flanged
T41229	Acero Poleas/Lisa (40mm x 8mm x 36mm)
T41230	Acero Poleas/Lisa (28mm x 8mm x 34mm)
T41232	Acero Poleas/Lisa (55mm x 19mm x 24mm)
T41237	EUR
T41241	EUR



**Master Automotriz 2010**  
**Productos Gates \* Características y especificaciones**

## Guía de Tensores DriveAlign® y PowerGrip®

Listado por número de parte

No. Parte	Dimensiones
T42002	Acero Poleas/Lisa (70mm x 10.4mm x 38mm)
T42005	Acero Poleas/Lisa (52mm x 10.5mm x 25mm)
T42016	Acero Poleas/Lisa (55mm x 10.3mm x 25mm)
T42017	Acero Poleas/Lisa (60mm x 10.5mm x 32mm)
T42018	Acero Poleas/Lisa (57.5mm x 10.3mm x 38mm) - Flanged
T42019	Acero Poleas/Lisa (28mm x 10mm x 27mm) - W/Bolt
T42020	Acero Poleas/Lisa (60mm x 10.5mm x 36mm)
T42021	Acero Poleas/Lisa (50mm x 10.5mm x 36mm)
T42023	Acero Poleas/Lisa (60mm x 10.5mm x 35mm)
T42024	Steel Cog (60mm x 10.5mm x 35mm)
T42024	Steel Cog (60mm x 10.5mm x 35mm)
T42025	Acero Poleas/Lisa (57.5mm x 12mm x 29mm)
T42030	Acero Poleas/Lisa (62mm x 12mm x 36.5mm)
T42031	Acero Poleas/Lisa (66mm x 12mm x 37.5mm)
T42032	Plastica Lisa (48mm x 10.4mm x 29mm)
T42033	Plastica Lisa (60mm x 10.4mm x 28.5mm)
T42034	Termoplástico Poleas/Lisa (47mm x 17mm x 29mm)
T42035	Termoplástico Poleas/Lisa (70mm x 10.4mm x 29mm)
T42036	Termoplástico Poleas/Lisa (60mm x 10.4mm x 29mm) - C/Separador
T42038	Acero Poleas/Lisa (55mm x 19.2mm x 30mm)
T42061	EUR
T42115	Acero Poleas/Lisa (60mm x 10mm x 36mm)
T42121	Acero Poleas/Lisa (58mm x N/A x 35.2mm) - C/Perno
T42166	EUR
T43001	Acero Poleas/Lisa (67mm x 9mm x 33mm)
T43003	Termoplástico Poleas/Lisa (60mm x 8mm x 30mm)
T43004	Acero Poleas/Lisa (65mm x 8.5mm x 32mm)
T43005	Acero Poleas/Lisa (70mm x 8.5mm x 32mm)
T43006	Plastica Lisa (67mm x 8mm x 30mm) - Flanged
T43007	Acero Poleas/Lisa (67mm x 8mm x 30mm) - C/Bridas
T43008	Acero Poleas/Lisa (67mm x 8mm x 33mm)
T43010	Acero Poleas/Lisa (72mm x 8mm x 30mm) - C/Bridas
T43016	Acero Poleas/Lisa (72mm x 18mm x 30mm) - Flanged, C/Perno, Bushing, Bolt, Washer
T43017	Acero Poleas/Lisa (72mm x 10mm x 30mm) - Flanged, W/Bushing, Bolt



## Master Automotriz 2010

### Productos Gates \* Características y especificaciones

No. Parte	Dimensiones
T43023	Acero Poleas/Lisa (70mm x 8mm x 30mm)
T43027	Actuador
T43029	Actuador
T43032	Sin Polea
T43039	Plastica Lisa (60.6mm x NA x 29.6mm) - C/Perno, Spring
T43064	Acero Poleas/Lisa (65.4mm x 8.1mm x 32mm)
T43066	Actuador
T43068	EUR
T43073	Actuador
T43091	Acero Poleas/Lisa (68mm x 8.2mm x 36mm) - C/Bridas, C/Resorte
T43095	Sin Polea
T43096	Sin Polea
T43097	Sin Polea
T43098	Sin Polea
T43131	Acero Poleas/Lisa (67mm x 9mm x 33mm)
T43132	Acero Poleas/Lisa (67mm x 8mm x 33mm) - C/Base
T43142	EUR
T43163	EUR
T43166	EUR
TMV-13001	Acero Poleas/Lisa (70mm x 15mm x 26mm)
TMV-14001	Acero Poleas/Lisa (76.2mm x 15mm x 35mm)
TMV-22001	Acero Poleas/Lisa (76.2mm x 15mm x 35mm) (Dos poleas lisas)
TMV-22002	Acero Polea/Ranurada ( 77.2mm x 15mm x 35mm) (Polea lisa y Polea Ranurada)
TMV-23001	Acero Polea/Lisa (70mm x 10.9mm x 22mm)
TPG-14001	Acero Polea/Lisa (59mm x 8mm x 22mm)
TPG-14002	Acero Polea/Lisa (59mm x 8mm x 26mm)
TPG-14003	Acero Polea/Lisa (59mm x 8mm x 19mm)
TPG-14004	Acero Polea/Lisa (59mm x 13.8mm x 22mm)
TPG-20001	Acero Polea/Lisa (59mm x 13mm x 22mm)
TPG-22001	Acero Polea/Lisa (73mm x 8mm x 27mm)
TPG-23001	Acero Polea/Lisa (62mm x 8mm x 22mm)

## Master Automotriz 2010

### Productos Gates \* Características y especificaciones



### Nomenclatura de Bandas:

<p><b>BANDAS V DENTADAS (GS)</b></p>	<p><b>Identificación:</b> Los números de la banda indican su ancho y largo, por lo que esta información puede ser usada para identificar el equivalente a una muestra</p> <ul style="list-style-type: none"> <li>El Primer número indica el ancho de la banda en 1/16 de pulgada. Los siguientes tres números indican la longitud, aproximada, de la banda, incluyendo la décima de pulgada; las siglas "GS" indican el tipo de construcción "Green Stripe", la cual es de alto desempeño.</li> </ul>	<p><b>Ejemplo:</b></p> <ul style="list-style-type: none"> <li><u>Número de banda:</u> 6555 GS</li> <li><u>Ancho (W):</u> El primer dígito es 6 (6555) por lo tanto mide 6/16" que es igual a 3/8".</li> <li><u>Largo:</u> Los siguientes tres dígitos son 555 que son 55.5 pulgadas es decir 55 1/2 pulgadas de largo.</li> <li><u>GS:</u> Indica que es dentada.</li> </ul>
<p><b>BANDAS V DENTADAS XL Y LAMINADAS</b></p>	<p><b>Identificación:</b> Los números de la banda indican su ancho y largo, por lo que esta información puede ser usada para identificar el equivalente a una muestra</p> <p>El Primer número indica el ancho de la banda en 1/16 de pulgada. Los siguientes tres números indican la longitud aproximada de la banda, incluyendo la décima de pulgada. En algunos casos existe una letra en el número de la Banda, la cual indica una característica especial de construcción, L=laminada.</p>	<p><b>Ejemplo:</b></p> <ul style="list-style-type: none"> <li><u>Número de banda:</u> 9540</li> <li><u>Ancho (W):</u> El primer numero es 9 (9540), equivalente a 1/2".</li> <li><u>Largo:</u> Los siguientes tres dígitos son 540 (9540), los que indican 54.0 pulgadas de largo.</li> </ul>
<p><b>Banda GS® PLATINUM QUALITY</b></p>	<p><b>Identificación:</b> Los números de la banda indican su ancho y largo, por lo que esta información puede ser usada para identificar el equivalente a una muestra</p> <p>Las primeras letras indican el nombre de la marca de estas bandas, indicación de Servicio Pesado (PQ=Platinum Quality), los dos primeros números indican el ancho en 1/32" de pulgada; los tres números restantes indican la longitud aproximada en pulgadas, incluyendo la fracción decimal.</p>	<p><b>Ejemplo:</b></p> <ul style="list-style-type: none"> <li><u>Número de banda:</u> PQ17400</li> <li><u>Línea:</u> PQ, Platinum Quality</li> <li><u>Ancho (W):</u> Los dos primeros dígitos son 17 (PQ17400) por lo tanto mide 17/32".</li> <li><u>Largo:</u> Los siguientes tres dígitos son 400 (PQ17400) que son 40.0 pulgadas..</li> </ul>
<p><b>BANDAS HI-POWER II SECCION A</b></p>	<p><b>Identificación:</b> La letra y los números de la banda indican su ancho y largo, por lo que esta información puede ser usada para identificar el equivalente a una muestra</p> <p>La primera letra indica el ancho constante de 1/2" pulgada; los dos números restantes indican la longitud interior en pulgadas; para determinar su longitud exterior se sumarán 2" al número indicado.</p>	<p><b>Ejemplo:</b></p> <ul style="list-style-type: none"> <li><u>Número de banda:</u> A16</li> <li><u>Ancho:</u> La letra A indica ancho de 1/2".</li> <li><u>Largo:</u> Los dos dígitos son 16 (A16) que son 16" pulgadas; la longitud exterior es 16+2=18".</li> </ul>
<p><b>BANDAS HI-POWER II SECCION A</b></p>	<p><b>Identificación:</b> La letra y los números de la banda indican su ancho y largo, por lo que esta información puede ser usada para identificar el equivalente a una muestra</p> <p>La primera letra indica el ancho constante de 21/32" pulgada; los dos números restantes indican la longitud interior en pulgadas; para determinar su longitud exterior se sumarán 3" al número indicado.</p>	<p><b>Ejemplo:</b></p> <ul style="list-style-type: none"> <li><u>Número de banda:</u> B50</li> <li><u>Ancho:</u> La letra B indica ancho de 21/32".</li> <li><u>Largo:</u> Los dos dígitos son 50 (B50) que son 50" pulgadas; la longitud exterior es 50+3=53".</li> </ul>

## Master Automotriz 2010

### Productos Gates \* Características y especificaciones

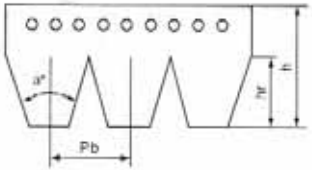
#### Nomenclatura de Bandas:

<p><b>BANDAS MICRO V</b></p> <p>Pb(mm):3.56      hr(mm):2.4 h(mm) :4.8±0.2      a°:40°±1°</p> 	<p><b>Identificación:</b> La letra y los números de la banda indican el tipo de sección, el número de costillas (ribs) y el largo, por lo que esta información puede ser usada para identificar el equivalente a una muestra</p> <p>La primera letra indica el tipo de sección o distancia entre costilla y costilla; este valor es universal para todas las bandas automotrices a nivel mundial; los dos primeros números indican el número de costillas (ribs) de la banda, y las 4 cifras restantes indican la longitud efectiva en pulgadas.</p>	<p><b>Ejemplo:</b></p> <ul style="list-style-type: none"> <li>• <u>Número de banda:</u> K030240</li> <li>• <u>Sección:</u> Distancia entre costillas, 1/8"</li> <li>• <u>Ribs:</u> La dos cifras indican el número de costillas 03 (K030240).</li> <li>• <u>Largo:</u> Las cuatro cifras restantes indican la longitud efectiva de 24.0" (K030240).</li> </ul>
<p><b>BANDAS TIMING</b></p> 	<p><b>Identificación:</b> La letra y los números de la banda, exceptuando la "T", no guardan ninguna relación con las dimensiones de la banda u otra de sus características.</p> <p>La "T" indica que se trata de una banda de tiempo. En este tipo de bandas es importante que lo siguiente sea corroborado:</p> <ul style="list-style-type: none"> <li>• Tipo de diente (trapezoidal, curvilíneo, curvilíneo modificado)</li> <li>• Número de dientes.</li> <li>• Ancho de la banda.</li> </ul>	<p><b>Ejemplo:</b></p> <ul style="list-style-type: none"> <li>• Hay que referirse a la tabla de dimensiones.</li> </ul>
<p><b>BANDAS PARA MOTONETAS y ATV's (Cuatrimotos)</b></p> 	<p><b>Identificación:</b> <b>PowerLink Nacional:</b> Su descripción inicial "PowerLink" representa la línea de bandas para motonetas. Los siguientes tres números corresponde al largo de la banda, el número intermedio corresponde al ancho y los últimos dos dígitos al ángulo.</p> <p><b>PowerLink Importada:</b> Su descripción inicial (PL) "PowerLink" representa la línea de bandas para motonetas y/o cuatrimotor. Los siguientes dos números corresponde a la Serie PL20 = Estándar, PL30 = Premium y los últimos tres dígitos un consecutivo.</p>	<p><b>Ejemplo:</b></p> <ul style="list-style-type: none"> <li>• <b>PowerLink Nacional:</b> <u>Número de banda:</u> Powerlink 642 15.5 28 <u>Largo:</u> 642. <u>Ancho:</u>15.5 <u>Angulo:</u> 28°</li> <li>• <b>PowerLink Importada:</b> <u>Número de banda:</u> PL30504 <u>Serie:</u> PL20: Estándar PL30 Premium <u>Consecutivo:</u> 504.</li> </ul>



# Master Automotriz 2010

## Productos Gates \* Características y especificaciones



### Banda V Dentada

Para la transmisión de potencia en poleas en V. Fabricada con dientes moldeados que reducen el patinamiento y el rechinido. Más durables que las bandas lisas por su construcción, materiales y forma.

**GS:** Bandas dentadas nacional

**XL:** Bandas dentadas importación

**L :** Bandas laminadas

Número	Pulg.	mm	Número	Pulg.	mm	Número	Pulg.	mm	Número	Pulg.	mm	Número	Pulg.	mm
<b>Ancho : 1/4"; 6.3 mm</b>			6471 GS	47 1/2	1206	6465 GS	47	1192	8324 GS	32 1/2	825	8389 GS	39	989
7261 XL	26 1/4	667	6480 GS	48 1/4	1226	6471 GS	47 1/2	1206	8334 GS	33 1/2	850	8395 GS	39 1/4	997
7279 XL	28 1/4	718	6490 GS	49 1/2	1258	7473 XL	47 7/8	1215	8345 GS	34 3/8	873	8400 GS	40	1015
7298 XL	30 1/4	770	6494 GS	49 1/2	1258	6475 GS	47 1/2	1207	8350 GS	35 1/2	902	8404 GS	40 1/4	1022
7309 XL	31 1/4	794	6500 GS	50 1/2	1282	6480 GS	48 1/4	1226	8360 GS	36 1/6	919	9403 XL	40 5/8	1030
7318 XL	32 1/2	825	6513 GS	51 1/2	1308	7483 XL	48 7/8	1240	8371 GS	37 1/4	946	8405 GS	40 5/8	1032
7329 XL	33 1/4	845	6523 GS	52 1/2	1333	6485 GS	48 5/6	1240	8380 GS	38 1/4	972	8416 GS	41 1/2	1055
7333 XL	34 1/4	870	6530 GS	53 1/2	1358	6490 GS	49 1/2	1258	8389 GS	38 6/7	987	9415 XL	41 7/8	1065
7348 XL	35 1/4	895	6543 GS	54 1/6	1376	6494 GS	49 3/5	1260	8395 GS	39	990	PQ17420	42 1/4	1073
7359 XL	36 1/4	920	6555 GS	55 1/2	1410	6500 GS	50 1/2	1282	8400 GS	40	1015	8435 GS	44	1117
7363 XL	36 3/4	935	6563 GS	56 3/8	1432	7508 XL	51 1/8	1300	8404 GS	40 1/4	1022	PQ17430	43 1/2	1104
7381 XL	38 1/4	970	6567 GS	57	1446	6513 GS	51 1/2	1308	8405 GS	40 5/8	1032	9435 XL	44 3/8	1127
7388 XL	39 1/4	995	6574 GS	57 1/2	1460	7516 XL	52 1/8	1325	8416 GS	41 3/4	1060	8445 GS	44 1/2	1130
<b>Ancho : 5/16"; 8 mm</b>			6580 GS	58 1/2	1485	6523 GS	52 1/2	1333	8430 GS	43	1090	8450 GS	45 1/2	1155
5310 GS	31	788	6607 GS	60 3/4	1543	7525 XL	53 1/8	1350	8445 GS	44 1/2	1130	8455 GS	46 1/6	1173
7228 XL	23	584	6615 GS	61 1/2	1562	6530 GS	53 1/2	1358	8450 GS	45 1/2	1155	8468 GS	46 3/4	1187
7234 XL	23 3/4	603	6622 GS	62 1/4	1581	7535 XL	54 1/8	1375	8452L	45 5/6	1164	8473 GS	47 1/2	1206
7274 XL	27 1/6	690	6641 GS	64	1628	7541 XL	54 5/8	1385	8468 GS	46 3/4	1187	8476 GS	48 1/4	1226
6305 GS	30 3/4	781	6215 GS	21 3/4	552	7545 XL	55 1/8	1400	8473 GS	47 1/2	1206	8484 GS	48 1/2	1231
6325 GS	32 5/6	834	6240 GS	24 5/6	631	6555 GS	55 1/2	1410	8484 GS	48 1/2	1231	9490 XL	49 3/8	1255
7334 XL	33 5/6	859	6250 GS	25 5/8	651	7555 XL	56 1/8	1425	8494 GS	49 1/2	1257	8494 GS	49 1/2	1257
7343 XL	34 1/4	870	6255 GS	26 1/6	665	6567 GS	56 3/4	1441	8497 GS	50	1271	8500 GS	50 5/8	1286
7374 XL	37 5/6	961	6260 GS	26 1/4	667	6574 GS	57 1/2	1460	8500 GS	50 5/8	1286	9505 XL	50 7/8	1290
7379 XL	38 1/4	970	6265 GS	27	684	7575 XL	58 1/8	1475	8510 GS	51	1296	8515 GS	51 1/2	1309
7384 XL	38 3/4	985	6275 GS	27 1/2	698	6580 GS	58 1/2	1485	8515 GS	51 1/2	1309	8520 GS	52 1/2	1333
7389 XL	39 1/4	995	6280 GS	28 1/2	723	6585 GS	58 5/6	1494	8520 GS	52 1/2	1333	8525 GS	52 3/4	1340
6405 GS	41	1039	6294 GS	29 3/8	746	7590 XL	59 5/8	1515	8533 GS	53 1/2	1358	8533 GS	53 1/2	1358
6420 GS	42 1/2	1079	6295 GS	30	760	7597 XL	60 1/8	1525	8543 GS	54 3/8	1381	8543 GS	54 3/8	1381
7444 XL	44 3/4	1135	6300 GS	30 1/4	768	7603 XL	60 5/8	1540	8553 GS	55 5/8	1413	9545 XL	54 7/8	1395
7459 XL	46 1/4	1175	6312 GS	31 3/8	797	6615 GS	61 1/2	1562	8563 GS	56 3/8	1432	9550 XL	55 3/8	1405
7496 XL	49 5/8	1260	6315 GS	32	811	7619 XL	62 5/8	1590	8573 GS	57 1/2	1460	8563 GS	56 3/8	1432
<b>Ancho : 3/8"; 9.5 mm</b>			6320 GS	32 1/2	825	7625 XL	63 1/8	1605	8580 GS	58 1/2	1485	9565 XL	57 1/8	1450
6260 GS	26 1/4	667	6325 GS	32 5/6	834	7630 XL	63 5/8	1615	8594 GS	59 3/8	1508	8573 GS	57 1/2	1460
6263 GS	26 3/8	670	6328 GS	33	837	7640 XL	64 5/8	1640	8608 GS	60 5/6	1545	8580 GS	58 1/2	1485
6275 GS	27 1/2	698	6334 GS	33 1/2	850	7650 XL	65 5/8	1665	8616 GS	61 3/4	1568	8585 GS	58 5/6	1494
6280 GS	28 1/2	723	6335 GS	33 5/6	859	7660 XL	66 5/8	1690	8643 GS	64 3/4	1645	8594 GS	59 3/8	1508
6294 GS	29 3/8	746	6340 GS	34 3/8	873	7665 XL	67 1/8	1705	8245 GS	25	634	8600 GS	60 1/4	1530
6315 GS	32	811	6345 GS	34 5/6	885	7673 XL	67 5/8	1720	8255 GS	25 5/6	656	8608 GS	60 5/6	1545
6320 GS	32 1/2	825	6350 GS	35 1/2	901	7680 XL	68 5/8	1745	8260 GS	26 3/8	670	8616 GS	61 1/2	1563
6334 GS	33 1/2	850	6360 GS	35 5/6	910	7695 XL	70 1/8	1780	8265 GS	27	686	9620 XL	62 3/8	1585
6340 GS	34 3/8	873	6362 GS	36 1/4	921	7715 XL	72 1/8	1830	8270 GS	27 1/6	690	8625 GS	63 1/4	1607
6352 GS	35 1/4	895	6377 GS	37	940	7730 XL	73 5/8	1870	9279 XL	28 1/2	723	9630 XL	63 3/8	1610
6360 GS	35 5/6	910	6370 GS	37 1/4	946	7743 XL	74 5/8	1895	8290 GS	29 1/4	743	9635 XL	64 1/8	1630
6362 GS	36 1/4	921	6375 GS	37 3/4	959	7760 XL	76 5/8	1945	8295 GS	30	760	8643 GS	60 5/8	1540
6364 GS	36 3/8	924	6380 GS	38 1/4	972	7775 XL	78 1/8	1985	8300 GS	30 1/4	768	8650 GS	65 1/4	1657
6370 GS	37 1/4	946	6385 GS	39	991	<b>Ancho : 13/32"; 10.3 mm</b>			8305 GS	30 5/6	783	8660 GS	66 3/4	1695
6377 GS	37	940	6390 GS	39 4/9	1002	6208 GS	21 1/2	547	8310 GS	31 1/4	794	9670 XL	67 3/8	1710
6380 GS	38 1/4	972	6395 GS	39 5/6	1012	6305 GS	30 3/4	781	8313 GS	32	811	8680 GS	68 1/2	1739
6390 GS	39 1/2	1003	6400 GS	40 1/2	1028	<b>Ancho : 7/16"; 11.1 mm</b>			8324 GS	32 1/2	825	9690 XL	69 3/8	1760
6400 GS	40 1/2	1028	6405 GS	40 5/6	1037	7277 GS	27 1/2	698	8325 GS	32 3/4	832	9700 XL	70 3/8	1790
6405 GS	41	1039	6413 GS	41 3/8	1051	7306 GS	30 1/4	768	8334 GS	33 1/2	850	9710 XL	71 3/8	1815
6413 GS	41 3/8	1051	7417 XL	42 1/8	1070	7336L	36 7/8	938	8335 GS	33 5/6	859	9720 XL	72 3/8	1840
6417 GS	42	1065	6420 GS	42 1/4	1073	7362 GS	36 1/6	919	8345 GS	34 3/8	873	9730 XL	73 3/8	1865
6427 GS	42 7/8	1089	6427 GS	42 7/8	1089	7371 GS	37 1/6	944	8350 GS	35 1/2	902	9740 XL	74 3/8	1890
6433 GS	43 1/2	1104	6433 GS	43 1/2	1104	7413 GS	41 1/4	1048	8355 GS	36	916	9745 XL	74 7/8	1900
6436 GS	43 3/4	1111	6436 GS	43 5/8	1108	7440 GS	43 5/8	1108	8360 GS	36 1/6	919	9755 XL	75 7/8	1925
6444 GS	44 3/8	1127	6444 GS	44 3/8	1127	<b>Ancho : 1/2"; 12.7 mm</b>			8365 GS	37	940	9765 XL	76 7/8	1955
6450 GS	45 1/2	1155	7448 XL	45 3/8	1155	8371 GS	37 1/6	944	8371 GS	37 1/6	944	9770 XL	77 3/8	1965
6463 GS	46 1/6	1173	6450 GS	45 1/3	1151	8375 GS	38	966	8375 GS	38	966	9775 XL	77 7/8	1980
			6453 GS	45 5/8	1159	9378 XL	38 1/8	970	9378 XL	38 1/8	970	9810 XL	81 3/8	2065
			6463 GS	46	1170	8380 GS	38 1/2	977	8380 GS	38 1/2	977	9850 XL	85 3/8	2170





## Master Automotriz 2010

### Productos Gates \* Características y especificaciones



#### Banda GS® PLATINUM QUALITY

Banda dentada para servicio pesado de alto desempeño. Fabricada con dientes de perfil de larga vida y gran flexibilidad, con fibras sintéticas para mayor resistencia, núcleo tensor Flex-Bonded y cubierta Flex-Weave® para lograr la mejor relación costo/desempeño. Es 33% más durable que la mejor banda para servicio pesado de otros fabricantes.

Número	Longitud Pulg.	Longitud mm	Número	Longitud Pulg.	Longitud mm	Número	Longitud Pulg.	Longitud mm
<b>Ancho: 1/2" - 12.7 mm</b>			PQ24493	49 1/2	1258	PQ28492	49 3/4	1264
PQ17400	40	1014	PQ24495	49 5/6	1266	PQ28497	50 1/2	1282
PQ17420	42 1/2	1079	PQ24503	50 5/8	1286	PQ28501	51	1294
PQ17430	43 1/2	1104	PQ24545	54 7/8	1394	PQ28510	51 1/2	1308
PQ17440	44 1/2	1130	PQ24570	57 1/2	1460	PQ28514	52	1320
PQ17450	45 1/2	1155	PQ24710	71 1/2	1815	PQ28522	52 3/4	1340
PQ17460	46 1/6	1173	PQ24895	90	2288	PQ28545	55	1397
PQ17470	47 1/2	1207	PQ24901	90 1/6	2290	PQ28580	58 1/2	1486
PQ17480	48 1/2	1232	<b>Ancho: 7/8" - 20 mm</b>			PQ28596	60 1/8	1527
PQ17490	49 3/4	1264	PQ28400	40 1/2	1028	PQ28640	64 3/8	1635
<b>Ancho: 1/2" - 12.7 mm</b>			PQ28406	41	1042			
PQ17500	50 5/8	1286	PQ28412	41 3/4	1060			
PQ17510	51 1/2	1308	PQ28423	42 3/4	1086			
PQ17520	52 1/2	1334	PQ28429	43 1/2	1104			
PQ17530	53 1/2	1359	PQ28437	44 1/6	1122			
PQ17540	54 1/2	1384	PQ28445	45	1142			
PQ17550	55 3/4	1416	PQ28454	45 5/6	1164			
<b>Ancho: 11/16" - 17 mm</b>			PQ28463	47	1192			
PQ24315	32	812	PQ28473	47 3/4	1213			
PQ24434	43 5/8	1108	<b>Ancho: 7/8" - 20 mm</b>					
PQ24485	49	1247	PQ28480	48 1/2	1231			
			PQ28483	48 5/6	1240			



#### Banda Vulco®

Banda forrada recomendada para transmitir potencia y movimiento en poleas en V. Ideal para los motores de Volkswagen enfriados por aire, como el del Sedán por sus características especiales de tensado de la banda.

Número	Ancho y Longitud Pulg.	Ancho y Longitud mm
8234	3/8 x 36	9.5 x 917
8251	1/2 x 56 1/4	12.7 x 1,429
8274	1/2 x 67 1/2	12.7 x 1,713
8282	1/2 x 62 3/4	12.7 x 1,594





## Master Automotriz 2010

### Productos Gates \* Características y especificaciones



#### Banda Super HC®

Banda Industrial para transmitir potencia y movimiento en poleas en V para algunas aplicaciones de servicio pesado.

Número	Ancho y Longitud Pulg.	Ancho y Longitud mm
5V10	5/8 X 71	15.8 X 1803
5V600	5/8 X 60	15.8 X 1524
5V750	5/8 X 75	15.8 X 1905



#### Banda Truck Belt

Bandas dentadas para servicio pesado con sección SAE.

Número	Pulg.	mm	Número	Pulg.	mm	Número	Pulg.	mm	Número	Pulg.	mm	Número	Pulg.	mm
<b>Ancho= 5/8" - 16 mm</b>			TR22525	53	1346	<b>Ancho= 3/4" - 19 mm</b>			TR28616	62 1/4	1581	<b>Ancho= 1" - 25 mm</b>		
TR20412	41 3/4	1060	TR22534	53 7/8	1368	TR24530	53 1/2	1359	TR28628	63 3/8	1610	TR32491	49 5/8	1260
TR20426	43 1/4	1099	<b>Ancho= 11/16" - 17 mm</b>			TR24538	54 3/8	1381	TR28649	65 1/2	1664	TR32513	51 7/8	1318
TR20451	45 5/8	1159	TR22553	55 7/8	1419	TR24562	56 3/4	1441	TR28657	66 1/2	1689	TR32571	57 5/8	1464
TR20544	54 7/8	1394	TR22578	58 3/8	1483	TR24578	58 3/8	1483	TR28666	67 1/4	1708	<b>Ancho= 1 1/16" - 27 mm</b>		
TR20619	62 1/2	1588	TR22588	59 3/8	1508	TR24597	60 1/2	1537	TR28680	68 1/2	1740	TR34435		1118
<b>Ancho= 11/16" - 17 mm</b>			TR22607	61 1/2	1562	TR24607	61 1/2	1562	TR28693	69 7/8	1775	TR34456	46 1/4	1175
TR22299	30 1/2	775	TR22625	63	1600	TR24619	62 1/2	1588	TR28706	71 1/4	1810	TR34467	47 1/2	1207
TR22322	32 3/4	832	TR22635	64	1626	TR24638	64 3/8	1635	TR28733	73 7/8	1876	TR34495	50	1270
TR22329	33 1/2	851	TR22648	65 3/8	1661	TR24647	65 1/2	1664	TR28743	74 7/8	1902	TR34506	51 1/4	1302
TR22336	34 1/4	870	TR22657	66 1/2	1689	TR24664	66 7/8	1699	TR28786	79 1/4	2013	TR34545	55	1397
TR22344	34 7/8	886	TR22664	66 7/8	1699	TR24688	69 3/8	1762	TR28883	88 7/8	2257	TR34603	60 7/8	1546
TR22350	35 1/2	902	TR22676	68 1/4	1734	TR24709	71 1/2	1816	<b>Ancho= 15/16" - 24 mm</b>			TR34604	60 7/8	1546
TR22358	36 3/8	924	TR22692	69 3/4	1772	<b>Ancho= 13/16" - 21 mm</b>			TR30408	41 3/8	1051	TR34625	63	1600
TR22363	36 7/8	937	TR22711	71 5/8	1819	TR26333	33 7/8	860	TR30428	43 3/8	1102	TR34646	65 1/4	1657
TR22373	37 7/8	962	TR22720	72 1/2	1842	TR26341	34 5/8	879	TR30448	45 3/8	1153	TR34698	70 3/8	1788
TR22386	39 1/4	997	TR22752	75 3/4	1924	TR26353	35 7/8	911	TR30467	47 1/2	1207	TR34700	70 1/2	1791
TR22392	39 3/4	1010	TR22770	77 1/2	1969	TR26366	37 1/4	946	TR30484	48 7/8	1241	TR34711	71 5/8	1819
TR22397	40 1/2	1029	TR22792	79 3/4	2026	<b>Ancho= 7/8" - 22 mm</b>			TR30506	51 1/4	1302	TR34743	74 7/8	1902
TR22400	40 1/2	1029	<b>Ancho= 3/4" - 19 mm</b>			TR28333	33 7/8	860	TR30537	54 1/2	1384	TR34765	77	1956
TR22405	41	1041	TR24355	36	914	TR28346	35 1/4	895	TR30543	54 7/8	1394	TR34771	77 5/8	1972
TR22410	41 1/2	1054	TR24365	37	940	TR28376	38 1/4	972	TR30598	60 3/8	1534	<b>Ancho= 1 3/16" - 30 mm</b>		
TR22416	42 1/4	1073	TR24379	38 1/2	978	TR28390	39 1/2	1003	TR30624	62 7/8	1597	TR38808	81 3/8	2067
TR22425	43	1092	TR24400	40 1/2	1029	TR28406	41 1/4	1048	TR30652	65 3/4	1670	<b>Ancho= 15/16" - 24 mm</b>		
TR22434	43 7/8	1114	TR24403	40 7/8	1038	TR28445	45	1143	TR30672	67 3/4	1721	TR30698	70 3/8	1788
TR22443	44 7/8	1140	TR24407	41 1/2	1054	<b>Ancho= 7/8" - 22 mm</b>			TR30710	71 1/2	1816	TR30722	72 3/4	1848
TR22448	45 3/8	1153	TR24414	41 7/8	1064	TR28550	55 1/2	1410	TR30754	75 7/8	1927	TR30770	77 1/2	1969
TR22455	46	1168	TR24424	42 7/8	1089	TR28557	56 1/2	1435	TR30808	81 3/8	2067	TR30831	83 5/8	2124
TR22461	46 5/8	1184	TR24449	45 1/2	1156	TR28565	57	1448	<b>Ancho= 15/16" - 24 mm</b>					
TR22474	47 7/8	1216	TR24465	47	1194	TR28570	57 1/2	1461	TR30672	67 3/4	1721			
TR22485	49	1245	TR24476	48 1/4	1226	TR28575	58	1473	TR30698	70 3/8	1788			
TR22495	50	1270	TR24489	49 1/2	1257	TR28583	58 7/8	1495	TR30710	71 1/2	1816			
TR22508	51 3/8	1305	TR24500	50 1/2	1283	<b>Ancho= 7/8" - 22 mm</b>			TR30722	72 3/4	1848			
TR22514	51 7/8	1318	TR24515	52	1321	TR28550	55 1/2	1410	TR30754	75 7/8	1927			
TR22517	52 1/2	1334				TR28557	56 1/2	1435	TR30770	77 1/2	1969			



# Master Automotriz 2010

## Productos Gates \* Características y especificaciones

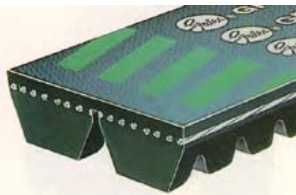

### Banda PowerBand®

Bandas unidas para transmitir potencia en poleas en V para aplicaciones de servicio pesado donde las bandas individuales se voltean por el alto torque en el momento del arranque o durante la aceleración.

Número	Bandas Unidas	Longitud Pulg. mm	Número	Bandas Unidas	Longitud Pulg. mm	Número	Bandas Unidas	Longitud Pulg. mm	Número	Bandas Unidas	Longitud Pulg. mm
<b>Ancho: 1/2"-12.7 mm</b>			<b>Ancho: 1/2"-12.7 mm</b>			<b>Ancho: 1/2"-12.7 mm</b>			2/9106 PK 2 106 2693		
2/9305 PB	2	30 7/8 785	2/9510 PB	2	51 7/9 1315	2/9660 PB	2	66 3/8 1685	<b>Ancho: 7/8"- 22 mm</b>		
2/9313 PB	2	32 815	2/9520 PB	2	52 3/8 1330	2/9670 PB	2	67 3/8 1710	2/TR28400 PB	2	40 5/9 1030
2/9325 PB	2	32 7/8 835	2/9530 PB	2	53 3/4 1365	2/9690 PB	2	69 2/3 1770	2/TR28429 PB	2	43 1/2 1105
2/9430 PB	2	43 7/8 1115	2/9540 PB	2	54 5/7 1390	2/9700 PB	2	70 7/8 1800	2/TR28437 PB	2	43 5/7 1110
2/9435 PB	2	44 3/8 1125	2/9545 PB	2	55 1/3 1405	2/9710 PB	2	71 2/3 1820	2/TR28473 PB	2	47 7/8 1215
2/9447 PB	2	45 3/8 1155	2/9550 PB	2	55 5/7 1415	2/9720 PB	2	72 1/4 1835	2/TR28480 PB	2	48 5/8 1220
2/9451 PB	2	45 7/8 1165	2/9555 PB	2	56 1/2 1435	2/9730 PB	2	73 3/8 1865	2/TR28483 PB	2	48 7/8 1240
2/9463 PB	2	46 7/8 1190	2/9570 PB	2	57 2/3 1465	2/9100 PK	2	100 2540	2/TR28492 PB	2	49 7/8 1265
2/9470 PB	2	47 7/8 1215	2/9590 PB	2	59 5/6 1520	2/9103 PK	2	103 2616	2/TR28501 PB	2	50 4/5 1290
2/9476 PB	2	48 3/8 1230	2/9610 PB	2	61 4/5 1570	2/9104 PK	2	104 2642			
2/9490 PB	2	49 4/5 1265	2/9640 PB	2	64 3/8 1635	2/9105 PK	2	105 2667			
2/9500 PB	2	50 7/9 1290	2/9650 PB	2	65 3/8 1660						



### Banda Tri-Power®

Bandas dentada para la transmisión de potencia en poleas en V, en maquinaria industrial y vehículos de servicio pesado. Combina las ventajas de las tradicionales bandas Hi-Power con las de las bandas dentadas.

#### TIPO "AX"

Número	Longitud Pulg.	Longitud mm	Número	Longitud Pulg.	Longitud mm	Número	Longitud Pulg.	Longitud mm	Número	Longitud Pulg.	Longitud mm	Número	Longitud Pulg.	Longitud mm
<b>Ancho: 1/2"-12.7 mm</b>			<b>Ancho: 1/2"-12.7 mm</b>			<b>Ancho: 1/2"-12.7 mm</b>			<b>Ancho: 1/2"-12.7 mm</b>			<b>Ancho: 1/2"-12.7 mm</b>		
AX22	24	610	AX39	41	1041	AX53	55	1397	AX67	69	1753	AX81	83	2108
AX23	25	635	AX40	42	1067	AX54	56	1422	AX68	70	1778	AX82	84	2134
AX24	26	660	AX41	43	1092	AX55	57	1448	AX69	71	1803	AX85	87	2210
AX26	28	711	AX42	44	1118	AX56	58	1473	AX70	72	1829	AX86	88	2235
AX27	29	737	AX43	45	1143	AX57	59	1499	AX71	73	1854	AX87	89	2261
AX28	30	762	AX44	46	1168	AX58	60	1524	AX72	74	1880	AX88	90	2286
AX29	31	787	AX45	47	1194	AX59	61	1549	AX73	75	1905	AX90	92	2337
AX31	33	838	AX46	48	1219	AX60	62	1575	AX74	76	1930	AX91	93	2362
AX32	34	864	AX47	49	1245	AX61	63	1600	AX75	77	1956	AX92	94	2388
AX33	35	889	AX48	50	1270	AX62	64	1626	AX76	78	1981	AX93	95	2413
AX34	36	914	AX49	51	1295	AX63	65	1651	AX77	79	2007	AX94	96	2438
AX35	37	940	AX50	52	1321	AX64	66	1676	AX78	80	2032	AX96	98	2489
AX36	38	965	AX51	53	1346	AX65	67	1702	AX79	81	2057	AX97	99	2515
AX37	39	991	AX52	54	1372	AX66	68	1727	AX80	82	2083	AX98	100	2540
AX38	40	1016												

#### TIPO "BX"

Número	Longitud Pulg.	Longitud mm	Número	Longitud Pulg.	Longitud mm	Número	Longitud Pulg.	Longitud mm	Número	Longitud Pulg.	Longitud mm	Número	Longitud Pulg.	Longitud mm
<b>Ancho: 21/32"-16.7 mm</b>			<b>Ancho: 21/32"-16.7 mm</b>			<b>Ancho: 21/32"-16.7 mm</b>			<b>Ancho: 21/32"-16.7 mm</b>			<b>Ancho: 21/32"-16.7 mm</b>		
BX28	31	787	BX46	49	1245	BX59	62	1575	BX72	75	1905	BX85	88	2235
BX31	34	864	BX47	50	1270	BX60	63	1600	BX73	76	1930	BX86	89	2261
BX32	35	889	BX48	51	1295	BX61	64	1626	BX74	77	1956	BX87	90	2286
BX34	37	940	BX49	52	1321	BX62	65	1651	BX75	78	1981	BX88	91	2311
BX35	38	965	BX50	53	1346	BX63	66	1676	BX76	79	2007	BX89	92	2337
BX36	39	991	BX51	54	1372	BX64	67	1702	BX77	80	2032	BX90	93	2362
BX37	40	1016	BX52	55	1397	BX65	68	1727	BX78	81	2057	BX91	94	2388
BX38	41	1041	BX53	56	1422	BX66	69	1753	BX79	82	2083	BX92	95	2413
BX40	43	1092	BX54	57	1448	BX67	70	1778	BX80	83	2108	BX93	96	2438
BX41	44	1118	BX55	58	1473	BX68	71	1803	BX81	84	2134	BX94	97	2464
BX42	45	1143	BX56	59	1499	BX69	72	1829	BX82	85	2159	BX95	98	2489
BX43	46	1168	BX57	60	1524	BX70	73	1854	BX83	86	2184	BX96	99	2515
BX44	47	1194	BX58	61	1549	BX71	74	1880	BX84	87	2210	BX97	100	2540
BX45	48	1219												



## Master Automotriz 2010

### Productos Gates \* Características y especificaciones



#### Banda Hi-Power® II

Banda forrada (lisa) industrial de amplia aplicación y desempeño en el mercado automotriz. Fabricada con hule sintético, paredes cóncavas y lomo arqueado, para mayor agarre sobre las poleas.

#### TIPO "A"

Número	Longitud Pulg.	Longitud mm	Número	Longitud Pulg.	Longitud mm	Número	Longitud Pulg.	Longitud mm	Número	Longitud Pulg.	Longitud mm	Número	Longitud Pulg.	Longitud mm
<b>Ancho: 1/2"-12.7 mm</b>			<b>Ancho: 3/4"-12.7 mm</b>			<b>Ancho: 1"-12.7 mm</b>			<b>Ancho: 1 1/4"-12.7 mm</b>			<b>Ancho: 1 1/2"-12.7 mm</b>		
A16	18	457	A32	34	864	A48	50	1270	A64	66	1676	A84	86	2184
A17	19	483	A33	35	889	A49	51	1295	A65	67	1702	A85	87	2210
A18	20	508	A34	36	914	A50	52	1321	A66	68	1727	A86	88	2235
A19	21	533	A35	37	940	A51	53	1346	A67	69	1753	A87	89	2261
A20	22	559	A36	38	965	A52	54	1372	A68	70	1778	A88	90	2286
A21	23	584	A37	39	991	A53	55	1397	A69	71	1803	A89	91	2311
A22	24	610	A38	40	1016	A54	56	1422	A70	72	1829	A90	92	2337
A23	25	635	A39	41	1041	A55	57	1448	A71	73	1854	A91	93	2362
A24	26	660	A40	42	1067	A56	58	1473	A76	78	1981	A92	94	2388
A25	27	686	A41	43	1092	A57	59	1499	A77	79	2007	A93	95	2413
A26	28	711	A42	44	1118	A58	60	1524	A78	80	2032	A94	96	2438
A27	29	737	A43	45	1143	A59	61	1549	A79	81	2057	A95	97	2464
A28	30	762	A44	46	1168	A60	62	1575	A80	82	2083	A96	98	2489
A29	31	787	A45	47	1194	A61	63	1600	A81	83	2108	A97	99	2515
A30	32	813	A46	48	1219	A62	64	1626	A82	84	2134	A98	100	2540
A31	33	838	A47	49	1245	A63	65	1651	A83	85	2159			

#### TIPO "B"

Número	Longitud Pulg.	Longitud mm	Número	Longitud Pulg.	Longitud mm	Número	Longitud Pulg.	Longitud mm	Número	Longitud Pulg.	Longitud mm	Número	Longitud Pulg.	Longitud mm
<b>Ancho: 21/32"-16.7 mm</b>			<b>Ancho: 21/32"-16.7 mm</b>			<b>Ancho: 21/32"-16.7 mm</b>			<b>Ancho: 21/32"-16.7 mm</b>			<b>Ancho: 21/32"-16.7 mm</b>		
B24	27	686	B39	42	1067	B54	57	1448	B69	72	1829	B84	87	2210
B25	28	711	B40	43	1092	B55	58	1473	B70	73	1854	B85	88	2235
B26	29	737	B41	44	1118	B56	59	1499	B71	74	1880	B86	89	2261
B27	30	762	B42	45	1143	B57	60	1524	B72	75	1905	B87	90	2286
B28	31	787	B43	46	1168	B58	61	1549	B73	76	1930	B88	91	2311
B29	32	813	B44	47	1194	B59	62	1575	B74	77	1956	B89	92	2337
B30	33	838	B45	48	1219	B60	63	1600	B75	78	1981	B90	93	2362
B31	34	864	B46	49	1245	B61	64	1626	B76	79	2007	B91	94	2388
B32	35	889	B47	50	1270	B62	65	1651	B77	80	2032	B92	95	2413
B33	36	914	B48	51	1295	B63	66	1676	B78	81	2057	B93	96	2438
B34	37	940	B49	52	1321	B64	67	1702	B79	82	2083	B94	97	2464
B35	38	965	B50	53	1346	B65	68	1727	B80	83	2108	B95	98	2489
B36	39	991	B51	54	1372	B66	69	1753	B81	84	2134	B96	99	2515
B37	40	1016	B52	55	1397	B67	70	1778	B82	85	2159	B97	100	2540
B38	41	1041	B53	56	1422	B68	71	1803	B83	86	2184			









## Master Automotriz 2010

### Productos Gates \* Características y especificaciones

#### Banda Micro-V®

Número	Número	Longitud Exterior Pulg.	mm	Número	Número	Longitud Exterior Pulg.	mm	Número	Número	Longitud Exterior Pulg.	mm	Número	Número	Longitud Exterior Pulg.	mm
K080910	8PK2311	91 5/8	2311	K081331	8PK3381	133 3/4	3381	K100675	10PK1715	68	1715	K120924	12PK2347	93	2347
K080915	8PK2324	92 1/8	2324	K081359	8PK3452	136 1/4	3452	K100708	10PK1798	70 4/5	1798	K120931	12PK2365	93 3/4	2365
K080922	8PK2342	92 3/4	2342	K081377	8PK3498	138	3498	K100731	10PK1857	73 3/8	1857	K120964	12PK2449	97	2449
K080934	8PK2372	93 7/8	2372	<b>9 costillas 1 1/4" - 32mm</b>				K100739	10PK1877	74	1877	K120979	12PK2487	98	2489
K080944	8PK2398	95	2398	K090500	9PK1270	50 3/8	1280	K100771	10PK1960	77	1958	<b>14 costillas 2" - 50mm</b>			
K080952	8PK2419	95 3/4	2418	K090609	9PK1547	61 1/4	1548	K100789	10PK2004	79 1/4	2004	K140345	14PK877	34 1/2	876
K080968	8PK2460	96 4/5	2459	<b>10 costillas 1 13/32" - 36mm</b>				K100810	10PK2057	81 5/8	2057	K140352	14PK894	35 3/4	894
K080968	8PK2460	96 4/5	2459	K100381	10PK968	39	968	K100852	10PK2164	85 7/8	2165	K140370	14PK940	37 1/2	940
K080975	8PK2475	97 1/2	2477	K100437	10PK1110	44	1110	K100891	10PK2263	89 3/4	2264	K140429	14PK1090	43 1/4	1090
K080981	8PK2492	98	2492	K100445	10PK1130	44 7/8	1130	<b>12 costillas 1 11/16" - 43mm</b>				K140433	14PK1100	43 7/8	1100
K080991	8PK2515	99	2517	K100456	10PK1158	46	1158	K120281	12PK714	28 5/8	714	K140451	14PK1146	45 3/4	1146
K081000	8PK2540	100	2540	K100465	10PK1181	46 1/2	1181	K120360	12PK914	36 1/4	914	K140500	14PK1270	50	1270
K081005	8PK2553	101 1/8	2553	K100485	10PK1232	49	1232	K120390	12PK990	39	991	K140524	14PK1331	53	1331
K081020	8PK2590	102	2591	K100495	10PK1257	49 1/2	1257	K120400	12PK1015	40	1016	K140555	14PK1410	56	1410
K081023	8PK2598	102 7/8	2598	K100510	10PK1295	51 5/8	1295	K120410	12PK1042	41	1041	K140580	14PK1473	58 5/8	1473
K081035	8PK2629	103 1/2	2629	K100535	10PK1360	53 1/2	1359	K120433	12PK1100	43 1/3	1100	K140603	14PK1532	60 1/3	1532
K081075	8PK2731	107 1/2	2731	K100540	10PK1372	54	1372	K120525	12PK1334	53	1334	K140618	14PK1570	62 3/8	1570
K081088	8PK2764	109 3/8	2764	K100554	10PK1407	56	1407	K120559	12PK1420	56 1/2	1420	K140627	14PK1593	63 1/4	1593
K081102	8PK2800	110 1/4	2799	K100563	10PK1430	56 7/8	1430	K120606	12PK1539	61 1/8	1539	K140662	14PK1682	66 1/4	1681
K081124	8PK2855	112 3/8	2855	K100570	10PK1448	57	1448	K120695	12PK1765	69 1/2	1765	K140682	14PK1732	68 3/4	1732
K081145	8PK2908	115 1/8	2908	<b>11 costillas 1 1/2" - 38mm</b>				K120720	12PK1835	72	1829	K140700	14PK1778	70 1/2	1778
K081153	8PK2929	116 1/4	2929	K100575	10PK1461	58	1461	K120735	12PK1865	73 1/2	1867				
K081177	8PK2990	118 1/4	2990	K100582	10PK1478	58 3/4	1478	K120740	12PK1880	74	1880				
K081189	8PK3021	119	3020	K100607	10PK1540	60 3/4	1542	K120815	12PK2070	82	2070				
K081196	8PK3038	120	3038	K100630	10PK1601	63	1600	K120842	12PK2139	84 7/8	2139				
K081207	8PK3066	121 1/4	3066	K100640	10PK1626	64	1626	K120864	12PK2195	86 3/8	2195				
K081213	8PK3081	121 7/8	3081	K100655	10PK1664	66	1664	K120872	12PK2215	87 4/5	2215				
K081223	8PK3106	122 3/4	3106	K100665	10PK1690	66 1/2	1689	K120878	12PK2230	88 3/4	2230				
K081251	8PK3178	125 3/8	3178	K100670	10PK1702	67	1702	K120901	12PK2289	90 5/8	2289				
K081265	8PK3213	127	3213					K120911	12PK2314	91 5/8	2314				
K081325	8PK3366	133	3366												

#### Banda Micro-V® de Doble Perfil

Banda	Dimensiones / Pulgadas	Dimensiones / mm
6DPK1200 (1195)	22/32 X 47 5/8	21 X 1195
DK060519	27/32 X 52 9/16	21 X 1318
DK060718	27/32 X 72 1/4	21 X 1824
6DPK1838	27/32 X 72 3/4	21 X 1838
DK060729	27/32 X 73 11/32	21 X 1852
7DPK1363	1 X 55 17/32	25.4 X 1363
DK070551	1 X 55 17/32	25.4 X 1400
DK070817	1 X 81 3/4	25.4 X 2076



## Master Automotriz 2010

### Productos Gates \* Características y especificaciones



### Banda de Distribución o Timing

Banda para la sincronización de los movimientos del motor, del cigüeñal y árbol(es) de levas. Fabricadas con dientes moldeados con HSN (Nitrilo Altamente Saturado) o CR (Neopreno) de la más alta calidad y cuerdas de fibra de vidrio de alta tenacidad y resistencia al calor.

Número	Longitud mm	Dientes (Cant. Tipo)	Ancho	Número	Longitud mm	Dientes (Cant. Tipo)	Ancho	Número	Longitud mm	Dientes (Cant. Tipo)	Ancho	Número	Longitud mm	Dientes (Cant. Tipo)	Ancho
T013	1162.0	122-T	19	T094	1028.7	108-C	24	T148	990.6	104-C	17	T203	1057.3	111-C	17
T014	1228.7	129-T	22.3	T095	847.7	89-T	19	T149	1160.0	145-C	21.1	T204	1171.6	123-C	24
T015	1228.7	129-T	19	T096	1114.4	117-T	25.4	T150	944.0	118-C	22	T205	1304.0	163-C	25.4
T016	1219.2	96-T	19	T097	723.9	76-T	19	T1502	1184	148-C	20	T206	1247.8	131-C	30
T017	1152.5	121-T	18	T098	1685.9	177-C	25	T1503	1457.3	153-CM	25.4	T207	2392.0	299-C	30
T018	1104.9	116-T	19	T099	962.0	101-C	24	T1504	1295.4	136-C	25.4	T208	1024.0	128-C	26
T019	1371.6	144-T	19	T100	904.9	95-T	19	T151	1112.0	139-C	28	T209	1928.0	241-C	34
T020	1390.6	146-T	19	T101	1352.0	169-C	25.4	T152	1133.5	119-C	25.4	T210	1228.7	129-C	22.3
T021	933.4	98-T	17	T1013	808	101-CM	20	T153	1181.1	124-C	23.8	T211	1076.3	113-C	21
T022	866.8	91-T	19	T102	742.9	78-C	19	T154	1544.0	193-C	36	T212	981.1	103-C	25.4
T023	981.1	103-T	19	T1022	1168	146-C	20	T1548	1080	135-C	19	T213	666.7	70-T	15.9
T024	1714.5	180-T	25.4	T103	1184.0	148-C	25.4	T155	1162.0	122-C	24	T214	1536.0	192-C	30
T025	885.8	93-T	19	T1034	1038.22	109-C	30	T1558	1257.3	132-CM	26	T215	1144.0	143-C	25.4
T026	1000.1	105-T	19	T104	1266.8	133-T	25.4	T156	1409.7	148-C	25.4	T216	1209.7	127-C	24
T027	762.0	80-T	19	T105	1314.4	138-C	28.5	T1565	1200,15	126-CM	27	T217	1362.1	143-C	21
T028	800.1	84-T	19	T1059	876.3	92-C	25	T157	1432.0	179-C	31.8	T218	1912.0	239-C	25.4
T029	1266.8	133-T	25.4	T106	1052.2	128-C	25	T1570	872	109-CM	25.4	T219	1600.0	200-C	30
T030	1028.7	108-T	19	T107	1114.4	117-C	19	T158	1162.0	122-C	19	T220	1744.0	218-C	31.8
T031	514.3	54-T	19	T108	1047.7	110-C	15	T1581	1276	134-CM	25.4	T221	1784.0	223-C	31.8
T032	1171.6	123-T	19	T1086	1114.42	117-CM	22	T159	523.9	55-C	12.7	T222	624.0	78-C	20
T034	1219.2	128-T	25.4	T109	2086.0	219-T	25.4	T1596	2072	259-CM	32	T223	981.1	103-C	24
T035	447.7	47-T	12.7	T1093	1160	145-C	26	T160	1028.7	108-C	24	T224	990.6	104-C	24
T036	895.3	94-T	19	T1094	1296	162-CM	20	T161	962.0	101-C	24	T225	1208.0	151-C	19
T037	945.0	99-T	15	T1095	1257.3	132-C	27	T162	896.0	112-C	19	T226	1240.0	155-C	24
T038	943.0	99-T	15	T1096	1552.6	163-CM	25.4	T163	1190.6	125-C	20	T227	1181.1	124-C	26
T039	945.0	99-T	19	T110	2086.0	219-C	25.4	T164	904.9	95-C	19	T228	1080.0	135-C	25.4
T040	962.0	101-T	25.4	T111	1104.9	116-C	19	T165	1438.3	151-C	29	T229	1171.6	123-C	19
T041	904.9	95-T	19	T112	1076.3	113-C	19	T166	923.9	97-T	19	T230	1181.1	124-C	29
T042	1409.7	148-T	19	T113	1038.2	109-C	19	T167	1457.3	153-C	29	T231	2295.5	241-C	28
T043	1285.9	135-T	25	T114	1200.1	126-T	23.8	T168	520.0	65-C	12.7	T232	1171.6	123-C	29
T045	1057.3	111-T	25.4	T115	1133.5	119-C	19	T169	1272.0	159-C	25.4	T233	1016.0	127-C	24
T048	1714.5	180-T	25.4	T116	933.4	98-C	19	T170	1136.0	142-C	19	T234	1171.6	123-C	19
T061	954.5	100-T	19	T117	1038.2	109-C	22	T171	1133.5	119-C	25	T235	968.0	121-C	21.1
T062	523.9	55-T	12.7	T118	896.0	112-C	17	T172	1688.0	211-C	30	T236	936.0	117-C	21.1
T063	876.3	92-T	19	T119	1181.1	124-C	19	T173	1562.1	164-C	23	T237	1272.0	159-C	25.4
T064	1143.0	120-T	19	T120	1276.3	134-T	25.4	T174	1047.7	110-C	14	T238	1181.1	124-C	25.4
T065	1076.3	113-T	19	T121	1057.3	111-T	19	T175	920.0	115-C	25.4	T239	895.3	94-T	19
T067	923.9	97-T	25.4	T122	1095.4	115-T	20	T176	1076.3	113-C	19	T240	1544.0	193-C	36
T068	1409.7	148-T	19	T123	856.0	107-C	19	T177	896.0	112-C	25	T241	923.9	97-C	19
T069	1123.9	118-T	19	T124	1171.6	123-C	19	T178	866.8	91-C	19	T242	1304.9	137-C	25.4
T070	838.2	88-T	19	T125	1424.0	178-C	25.4	T179	1160.0	145-C	22	T243	847.7	89-C	19
T071	1181.1	124-T	24.7	T126	1272.0	159-C	25.4	T180	1824.0	228-C	31.8	T244	1066.8	112-C	24
T072	762.0	80-T	15.9	T127	1143.0	120-T	18	T181	885.8	93-C	25	T245	1066.8	112-C	29
T073	876.3	92-T	19	T128	876.3	92-C	19	T182	904.9	95-C	25	T246	1428.7	150-C	29
T074	1352.5	142-T	25.4	T1284	1242	128-CM	27	T183	1912.0	239-C	35	T247	1200.1	126-C	26
T075	828.7	87-T	34	T129	1828.8	192-C	28	T184	1190.6	125-C	26	T248	1240.0	155-C	32
T076	1276.3	134-T	30	T130	1228.7	129-C	24	T185	856.0	107-C	21.5	T249	1266.8	133-C	25.4
T077	1009.6	106-T	19	T131	1043.9	127-C	25	T186	666.7	70-C	16	T250	1800.0	225-C	30
T078	933.4	98-T	19	T132	1200.1	126-C	23.8	T187	1076.3	113-C	24	T251	1824.0	228-C	31.8
T079	1209.7	127-T	25.4	T133	1176.0	147-C	25	T188	1266.8	133-C	25.4	T252	1409.7	148-C	23
T080	1171.6	123-T	25.4	T134	1047.7	110-C	25.4	T189	1076.3	113-C	17	T253	2120.0	265-C	32
T081	1057.3	111-C	20	T135	847.7	89-C	19	T190	1672.0	209-C	34	T254	1688.0	211-C	30
T082	714.4	75-T	20	T136	1016.0	127-C	24	T191	876.3	92-C	22	T255	1616.0	202-C	30
T083	1133.5	119-T	25	T137	1208.0	151-C	19	T192	1609.7	169-T	34	T256	1466.8	154-C	29
T084	1238.2	130-C	25.4	T138	1304.0	163-C	26.7	T193	1866.9	196-C	28	T257	1688.0	211-C	32
T085	971.5	102-T	19	T139	1419.2	149-C	25.4	T194	923.9	97-C	25.4	T258	1247.8	131-C	25.4
T086	657.2	69-T	19	T140	1123.9	118-C	19	T195	2056.0	257-C	32	T259	1496.0	187-C	32
T087	1324.0	139-T	25.4	T141	856.0	107-C	21.1	T196	2086.0	219-C	25.4	T260	1152.5	121-C	18
T088	1038.2	109-T	19	T142	1181.1	124-C	24	T197	1176.0	147-C	19	T261	847.7	89-C	23.8
T089	1162.0	122-C	19	T143	1009.6	106-C	24	T198	1590.7	167-C	23	T262	1181.1	124-C	18
T090	523.9	55-C	12.7	T144	1019.2	107-C	24	T199	1304.0	163-C	26.7	T263	1828.8	192-C	24
T091	1552.6	163-C	25.4	T145	1019.2	107-C	24	T200	1528.0	191-C	31.8	T264	1028.7	108-C	25.4
T092	790.6	83-C	19	T146	1384.0	173-C	30	T201	968.0	121-C	29	T265	1390.6	146-C	28
T093	1143.0	120-C	19	T147	1096.0	137-C	25.4	T202	1240.0	155-C	32	T266	1000.0	125-C	22





# Master Automotriz 2010

## Productos Gates \* Características y especificaciones

### Banda de Distribución o Timing

#### Búsqueda por descripción – (CONTINUA)

Número	Longitud mm	Dientes (Cant. Tipo)	Ancho	Número	Longitud mm	Dientes (Cant. Tipo)	Ancho	Número	Longitud mm	Dientes (Cant. Tipo)	Ancho	Número	Longitud mm	Dientes (Cant. Tipo)	Ancho
T267	1608.0	201-C	30	T287	1560.0	195-C	32	T307	1784.0	223-C	27	T332	1162	122-C	20
T268	1324.0	139-C	21	T288	928.0	116-C	29	T308	986.5	123-C	21.5	T333	1143	120-C	30
T269	1371.6	144-C	23	T289	856.0	107-C	25.4	T309	1352.0	169-C	24	T334	1184	148-C	23
T270	1447.8	152-C	28	T290	608.0	76-C	25	T310	1209.7	127-C	25.4	T335	1210	127-C	25
T271	1528.0	191-C	36	T291	1216.0	152-C	25	T311	1352.5	142-C	23	T709	1057.27	111-CM	25
T272	847.7	89-C	25.4	T292	1176.0	147-C	25	T312	990.6	104-C	22	T724	792	99-CM	19
T273	1600.0	200-C	34	T293	1047.7	110-C	18	T313	1401.8	175-C	29	T739	1162.05	122-C	26.5
T274	828.7	87-T	19	T294	1228.7	129-C	25.4	T314	520.7	65-C	12.7	T835	1228.72	129-C	31
T275	838.2	88-C	17	T295	1608.0	201-C	30	T315	1656.0	207-C	32	T894	1401.75	175-CM	16
T276	1247.8	131-C	22.3	T296	1104.0	138-C	23	T316	1064.0	133-C	25.4	T900	992	124-C	26
T277	2248.0	281-C	30	T297	2024.0	253-C	30	T317	1224.0	153-C	25	T901	1028.7	108-C	17
T278	1057.3	111-C	25.4	T298	1688.0	211-C	34	T319	1390	146-C	28	T901A	1002	104-C	17
T279	1876.4	197-C	24	T299	1133.5	119-C	19	T320	1608	201-C	32	T911	990.6	104-C	17
T280	552.0	69-C	15	T300	933.4	98-C	19	T321	1343	141-T	25	T915	1295.4	136-C	25.4
T281	1344.0	168-C	25.4	T301	1343.0	141-C	25	T324	881	110-C	22	T918	1104	138-C	15
T282	1000.1	105-C	22	T302	1232.0	154-C	21.5	T326	552	58-C	22	T961	1552.57	163-CM	25.4
T283	943.0	99-C	25.4	T303	1528.0	191-C	31.8	T328	2248	281-C	29				
T284	1076.3	113-C	25.4	T304	1784.0	223-C	27	T329	1576	197-C	20				
T285	1800.0	225-C	30	T305	1368.0	171-C	24	T330	2248	281-C	30				
T286	1576.0	197-C	26	T306	1200.0	150-C	23	T331	1353	142-C	23				

### Banda de Distribución o Timing

#### Búsqueda por ancho de la banda

Número	Longitud mm	Dientes (Cant. Tipo)	Ancho	Número	Longitud mm	Dientes (Cant. Tipo)	Ancho	Número	Longitud mm	Dientes (Cant. Tipo)	Ancho	Número	Longitud mm	Dientes (Cant. Tipo)	Ancho
T035	447.7	47-T	12.7	T030	1028.7	108-T	19	T158	1162.0	122-C	19	T179	1160.0	145-C	22
T062	523.9	55-T	12.7	T031	514.3	54-T	19	T162	896.0	112-C	19	T191	876.3	92-C	22
T090	523.9	55-C	12.7	T032	1171.6	123-T	19	T164	904.9	95-C	19	T266	1000.0	125-C	22
T159	523.9	55-C	12.7	T036	895.3	94-T	19	T166	923.9	97-T	19	T282	1000.1	105-C	22
T168	520.0	65-C	12.7	T039	945.0	99-T	19	T170	1136.0	142-C	19	T312	990.6	104-C	22
T314	520.7	65-C	12.7	T041	904.9	95-T	19	T176	1076.3	113-C	19	T324	881	110-C	22
T174	1047.7	110-C	14	T042	1409.7	148-T	19	T178	866.8	91-C	19	T326	552	58-C	22
T037	945.0	99-T	15	T061	954.5	100-T	19	T197	1176.0	147-C	19	T014	1228.7	129-T	22.3
T038	943.0	99-T	15	T063	876.3	92-T	19	T225	1208.0	151-C	19	T210	1228.7	129-C	22.3
T108	1047.7	110-C	15	T064	1143.0	120-T	19	T229	1171.6	123-C	19	T276	1247.8	131-C	22.3
T280	552.0	69-C	15	T065	1076.3	113-T	19	T234	1171.6	123-C	19	T173	1562.1	164-C	23
T918	1104	138-C	15	T068	1409.7	148-T	19	T239	895.3	94-T	19	T198	1590.7	167-C	23
T072	762.0	80-T	15.9	T069	1123.9	118-T	19	T241	923.9	97-C	19	T252	1409.7	148-C	23
T213	666.7	70-T	15.9	T070	838.2	88-T	19	T243	847.7	89-C	19	T269	1371.6	144-C	23
T186	666.7	70-C	16	T073	876.3	92-T	19	T274	828.7	87-T	19	T296	1104.0	138-C	23
T894	1401.75	175-CM	16	T077	1009.6	106-T	19	T299	1133.5	119-C	19	T306	1200.0	150-C	23
T021	933.4	98-T	17	T078	933.4	98-T	19	T300	933.4	98-C	19	T311	1352.5	142-C	23
T118	896.0	112-C	17	T085	971.5	102-T	19	T724	792	99-CM	19	T331	1353	142-C	23
T148	990.6	104-C	17	T086	657.2	69-T	19	T081	1057.3	111-C	20	T334	1184	148-C	23
T189	1076.3	113-C	17	T088	1038.2	109-T	19	T082	714.4	75-T	20	T114	1200.1	126-T	23.8
T203	1057.3	111-C	17	T089	1162.0	122-C	19	T1013	808	101-CM	20	T132	1200.1	126-C	23.8
T275	838.2	88-C	17	T092	790.6	83-C	19	T1022	1168	146-C	20	T153	1181.1	124-C	23.8
T901	1028.7	108-C	17	T093	1143.0	120-C	19	T1094	1296	162-CM	20	T261	847.7	89-C	23.8
T901A	1002	104-C	17	T095	847.7	89-T	19	T122	1095.4	115-T	20	T094	1028.7	108-C	24
T911	990.6	104-C	17	T097	723.9	76-T	19	T1502	1184	148-C	20	T099	962.0	101-C	24
T017	1152.5	121-T	18	T100	904.9	95-T	19	T163	1190.6	125-C	20	T130	1228.7	129-C	24
T127	1143.0	120-T	18	T102	742.9	78-C	19	T222	624.0	78-C	20	T136	1016.0	127-C	24
T260	1152.5	121-C	18	T107	1114.4	117-C	19	T329	1576	197-C	20	T142	1181.1	124-C	24
T262	1181.1	124-C	18	T111	1104.9	116-C	19	T332	1162	122-C	20	T143	1009.6	106-C	24
T293	1047.7	110-C	18	T112	1076.3	113-C	19	T211	1076.3	113-C	21	T144	1019.2	107-C	24
T013	1162.0	122-T	19	T113	1038.2	109-C	19	T217	1362.1	143-C	21	T145	1019.2	107-C	24
T015	1228.7	129-T	19	T115	1133.5	119-C	19	T268	1324.0	139-C	21	T155	1162.0	122-C	24
T016	1219.2	96-T	19	T116	933.4	98-C	19	T141	856.0	107-C	21.1	T160	1028.7	108-C	24
T018	1104.9	116-T	19	T119	1181.1	124-C	19	T149	1160.0	145-C	21.1	T161	962.0	101-C	24
T019	1371.6	144-T	19	T121	1057.3	111-T	19	T235	968.0	121-C	21.1				
T020	1390.6	146-T	19	T123	856.0	107-C	19	T236	936.0	117-C	21.1				
T022	866.8	91-T	19	T124	1171.6	123-C	19	T185	856.0	107-C	21.5				
T023	981.1	103-T	19	T128	876.3	92-C	19	T302	1232.0	154-C	21.5				
T025	885.8	93-T	19	T135	847.7	89-C	19	T308	986.5	123-C	21.5				
T026	1000.1	105-T	19	T137	1208.0	151-C	19	T1086	1114.42	117-CM	22				
T027	762.0	80-T	19	T140	1123.9	118-C	19	T117	1038.2	109-C	22				
T028	800.1	84-T	19	T1548	1080	135-C	19	T150	944.0	118-C	22				



## Master Automotriz 2010 Productos Gates \* Características y especificaciones

### Banda de Distribución o Timing Búsqueda por ancho de la banda - (CONTINUA).

Número	Longitud mm	Dientes (Cant. Tipo)	Ancho	Número	Longitud mm	Dientes (Cant. Tipo)	Ancho	Número	Longitud mm	Dientes (Cant. Tipo)	Ancho	Número	Longitud mm	Dientes (Cant. Tipo)	Ancho
T187	1076.3	113-C	24	T096	1114.4	117-T	25.4	T961	1552.57	163-CM	25.4	T254	1688.0	211-C	30
T204	1171.6	123-C	24	T101	1352.0	169-C	25.4	T1093	1160	145-C	26	T255	1616.0	202-C	30
T216	1209.7	127-C	24	T103	1184.0	148-C	25.4	T1558	1257.3	132-CM	26	T267	1608.0	201-C	30
T223	981.1	103-C	24	T104	1266.8	133-T	25.4	T184	1190.6	125-C	26	T277	2248.0	281-C	30
T224	990.6	104-C	24	T109	2086.0	219-T	25.4	T208	1024.0	128-C	26	T285	1800.0	225-C	30
T226	1240.0	155-C	24	T1096	1552.6	163-CM	25.4	T227	1181.1	124-C	26	T295	1608.0	201-C	30
T233	1016.0	127-C	24	T110	2086.0	219-C	25.4	T247	1200.1	126-C	26	T297	2024.0	253-C	30
T244	1066.8	112-C	24	T120	1276.3	134-T	25.4	T286	1576.0	197-C	26	T330	2248	281-C	30
T263	1828.8	192-C	24	T125	1424.0	178-C	25.4	T900	992	124-C	26	T333	1143	120-C	30
T279	1876.4	197-C	24	T126	1272.0	159-C	25.4	T739	1162.05	122-C	26.5	T835	1228.72	129-C	31
T305	1368.0	171-C	24	T134	1047.7	110-C	25.4	T138	1304.0	163-C	26.7	T157	1432.0	179-C	31.8
T309	1352.0	169-C	24	T139	1419.2	149-C	25.4	T199	1304.0	163-C	26.7	T180	1824.0	228-C	31.8
T071	1181.1	124-T	24.7	T147	1096.0	137-C	25.4	T1095	1257.3	132-C	27	T200	1528.0	191-C	31.8
T043	1285.9	135-T	25	T1503	1457.3	153-CM	25.4	T1284	1242	128-CM	27	T220	1744.0	218-C	31.8
T083	1133.5	119-T	25	T1504	1295.4	136-C	25.4	T1565	1200.15	126-CM	27	T221	1784.0	223-C	31.8
T098	1685.9	177-C	25	T152	1133.5	119-C	25.4	T304	1784.0	223-C	27	T251	1824.0	228-C	31.8
T1059	876.3	92-C	25	T156	1409.7	148-C	25.4	T307	1784.0	223-C	27	T303	1528.0	191-C	31.8
T106	1052.2	128-C	25	T1570	872	109-CM	25.4	T129	1828.8	192-C	28	T1596	2072	259-CM	32
T131	1043.9	127-C	25	T1581	1276	134-CM	25.4	T151	1112.0	139-C	28	T195	2056.0	257-C	32
T133	1176.0	147-C	25	T169	1272.0	159-C	25.4	T193	1866.9	196-C	28	T202	1240.0	155-C	32
T171	1133.5	119-C	25	T175	920.0	115-C	25.4	T231	2295.5	241-C	28	T248	1240.0	155-C	32
T177	896.0	112-C	25	T188	1266.8	133-C	25.4	T265	1390.6	146-C	28	T253	2120.0	265-C	32
T181	885.8	93-C	25	T194	923.9	97-C	25.4	T270	1447.8	152-C	28	T257	1688.0	211-C	32
T182	904.9	95-C	25	T196	2086.0	219-C	25.4	T319	1390	146-C	28	T259	1496.0	187-C	32
T290	608.0	76-C	25	T205	1304.0	163-C	25.4	T105	1314.4	138-C	28.5	T287	1560.0	195-C	32
T291	1216.0	152-C	25	T212	981.1	103-C	25.4	T165	1438.3	151-C	29	T315	1656.0	207-C	32
T292	1176.0	147-C	25	T215	1144.0	143-C	25.4	T167	1457.3	153-C	29	T320	1608	201-C	32
T301	1343.0	141-C	25	T218	1912.0	239-C	25.4	T201	968.0	121-C	29	T075	828.7	87-T	34
T317	1224.0	153-C	25	T228	1080.0	135-C	25.4	T230	1181.1	124-C	29	T190	1672.0	209-C	34
T321	1343	141-T	25	T237	1272.0	159-C	25.4	T232	1171.6	123-C	29	T192	1609.7	169-T	34
T335	1210	127-C	25	T238	1181.1	124-C	25.4	T245	1066.8	112-C	29	T209	1928.0	241-C	34
T709	1057.27	111-CM	25	T242	1304.9	137-C	25.4	T246	1428.7	150-C	29	T273	1600.0	200-C	34
T024	1714.5	180-T	25.4	T249	1266.8	133-C	25.4	T256	1466.8	154-C	29	T298	1688.0	211-C	34
T029	1266.8	133-T	25.4	T258	1247.8	131-C	25.4	T288	928.0	116-C	29	T183	1912.0	239-C	35
T034	1219.2	128-T	25.4	T264	1028.7	108-C	25.4	T313	1401.8	175-C	29	T154	1544.0	193-C	36
T040	962.0	101-T	25.4	T272	847.7	89-C	25.4	T328	2248	281-C	29	T240	1544.0	193-C	36
T045	1057.3	111-T	25.4	T278	1057.3	111-C	25.4	T076	1276.3	134-T	30	T271	1528.0	191-C	36
T048	1714.5	180-T	25.4	T281	1344.0	168-C	25.4	T1034	1038.22	109-C	30				
T067	923.9	97-T	25.4	T283	943.0	99-C	25.4	T146	1384.0	173-C	30				
T074	1352.5	142-T	25.4	T284	1076.3	113-C	25.4	T172	1688.0	211-C	30				
T079	1209.7	127-T	25.4	T289	856.0	107-C	25.4	T206	1247.8	131-C	30				
T080	1171.6	123-T	25.4	T294	1228.7	129-C	25.4	T207	2392.0	299-C	30				
T084	1238.2	130-C	25.4	T310	1209.7	127-C	25.4	T214	1536.0	192-C	30				
T087	1324.0	139-T	25.4	T316	1064.0	133-C	25.4	T219	1600.0	200-C	30				
T091	1552.6	163-C	25.4	T915	1295.4	136-C	25.4	T250	1800.0	225-C	30				

### Banda de Distribución o Timing Búsqueda por número de dientes

Número	Longitud mm	Dientes (Cant. Tipo)	Ancho	Número	Longitud mm	Dientes (Cant. Tipo)	Ancho	Número	Longitud mm	Dientes (Cant. Tipo)	Ancho	Número	Longitud mm	Dientes (Cant. Tipo)	Ancho
T035	447.7	47-T	12.7	T222	624.0	78-C	20	T063	876.3	92-T	19	T067	923.9	97-T	25.4
T031	514.3	54-T	19	T072	762.0	80-T	15.9	T073	876.3	92-T	19	T194	923.9	97-C	25.4
T062	523.9	55-T	12.7	T027	762.0	80-T	19	T128	876.3	92-C	19	T021	933.4	98-T	17
T090	523.9	55-C	12.7	T092	790.6	83-C	19	T191	876.3	92-C	22	T078	933.4	98-T	19
T159	523.9	55-C	12.7	T028	800.1	84-T	19	T1059	876.3	92-C	25	T116	933.4	98-C	19
T326	552	58-C	22	T274	828.7	87-T	19	T025	885.8	93-T	19	T300	933.4	98-C	19
T168	520.0	65-C	12.7	T075	828.7	87-T	34	T181	885.8	93-C	25	T037	945.0	99-T	15
T314	520.7	65-C	12.7	T275	838.2	88-C	17	T036	895.3	94-T	19	T038	943.0	99-T	15
T280	552.0	69-C	15	T070	838.2	88-T	19	T239	895.3	94-T	19	T039	945.0	99-T	15
T086	657.2	69-T	19	T095	847.7	89-T	19	T041	904.9	95-T	19	T724	792	99-CM	19
T213	666.7	70-T	15.9	T135	847.7	89-C	19	T100	904.9	95-T	19	T283	943.0	99-C	25.4
T186	666.7	70-C	16	T243	847.7	89-C	19	T164	904.9	95-C	19	T061	954.5	100-T	19
T082	714.4	75-T	20	T261	847.7	89-C	23.8	T182	904.9	95-C	25	T1013	808	101-CM	20
T097	723.9	76-T	19	T272	847.7	89-C	25.4	T016	1219.2	96-T	19	T099	962.0	101-C	24
T290	608.0	76-C	25	T022	866.8	91-T	19	T166	923.9	97-T	19	T161	962.0	101-C	24
T102	742.9	78-C	19	T178	866.8	91-C	19	T241	923.9	97-C	19	T040	962.0	101-T	25.4



## Master Automotriz 2010

### Productos Gates \* Características y especificaciones

#### Banda de Distribución o Timing

#### Búsqueda por número de dientes – (CONTINUA)

Número	Longitud mm	Dientes (Cant. Tipo)	Ancho	Número	Longitud mm	Dientes (Cant. Tipo)	Ancho	Número	Longitud mm	Dientes (Cant. Tipo)	Ancho	Número	Longitud mm	Dientes (Cant. Tipo)	Ancho
T085	971.5	102-T	19	T127	1143.0	120-T	18	T1548	1080	135-C	19	T309	1352.0	169-C	24
T023	981.1	103-T	19	T064	1143.0	120-T	19	T043	1285.9	135-T	25	T101	1352.0	169-C	25.4
T223	981.1	103-C	24	T093	1143.0	120-C	19	T228	1080.0	135-C	25.4	T192	1609.7	169-T	34
T212	981.1	103-C	25.4	T333	1143	120-C	30	T1504	1295.4	136-C	25.4	T305	1368.0	171-C	24
T148	990.6	104-C	17	T017	1152.5	121-T	18	T915	1295.4	136-C	25.4	T146	1384.0	173-C	30
T901A	1002	104-C	17	T260	1152.5	121-C	18	T147	1096.0	137-C	25.4	T894	1401.75	175-CM	16
T911	990.6	104-C	17	T235	968.0	121-C	21.1	T242	1304.9	137-C	25.4	T313	1401.8	175-C	29
T312	990.6	104-C	22	T201	968.0	121-C	29	T918	1104	138-C	15	T098	1685.9	177-C	25
T224	990.6	104-C	24	T013	1162.0	122-T	19	T296	1104.0	138-C	23	T125	1424.0	178-C	25.4
T026	1000.1	105-T	19	T089	1162.0	122-C	19	T105	1314.4	138-C	28.5	T157	1432.0	179-C	31.8
T282	1000.1	105-C	22	T158	1162.0	122-C	19	T268	1324.0	139-C	21	T024	1714.5	180-T	25.4
T077	1009.6	106-T	19	T332	1162	122-C	20	T087	1324.0	139-T	25.4	T048	1714.5	180-T	25.4
T143	1009.6	106-C	24	T155	1162.0	122-C	24	T151	1112.0	139-C	28	T259	1496.0	187-C	32
T123	856.0	107-C	19	T739	1162.05	122-C	26.5	T301	1343.0	141-C	25	T200	1528.0	191-C	31.8
T141	856.0	107-C	21.1	T032	1171.6	123-T	19	T321	1343	141-T	25	T303	1528.0	191-C	31.8
T185	856.0	107-C	21.5	T124	1171.6	123-C	19	T170	1136.0	142-C	19	T271	1528.0	191-C	36
T144	1019.2	107-C	24	T229	1171.6	123-C	19	T311	1352.5	142-C	23	T263	1828.8	192-C	24
T145	1019.2	107-C	24	T234	1171.6	123-C	19	T331	1353	142-C	23	T129	1828.8	192-C	28
T289	856.0	107-C	25.4	T308	986.5	123-C	21.5	T074	1352.5	142-T	25.4	T214	1536.0	192-C	30
T901	1028.7	108-C	17	T204	1171.6	123-C	24	T217	1362.1	143-C	21	T154	1544.0	193-C	36
T030	1028.7	108-T	19	T080	1171.6	123-T	25.4	T215	1144.0	143-C	25.4	T240	1544.0	193-C	36
T094	1028.7	108-C	24	T232	1171.6	123-C	29	T019	1371.6	144-T	19	T287	1560.0	195-C	32
T160	1028.7	108-C	24	T262	1181.1	124-C	18	T269	1371.6	144-C	23	T193	1866.9	196-C	28
T264	1028.7	108-C	25.4	T119	1181.1	124-C	19	T149	1160.0	145-C	21.1	T329	1576	197-C	20
T088	1038.2	109-T	19	T153	1181.1	124-C	23.8	T179	1160.0	145-C	22	T279	1876.4	197-C	24
T113	1038.2	109-C	19	T142	1181.1	124-C	24	T1093	1160	145-C	26	T286	1576.0	197-C	26
T117	1038.2	109-C	22	T071	1181.1	124-T	24.7	T020	1390.6	146-T	19	T219	1600.0	200-C	30
T1570	872	109-CM	25.4	T238	1181.1	124-C	25.4	T1022	1168	146-C	20	T273	1600.0	200-C	34
T1034	1038.22	109-C	30	T227	1181.1	124-C	26	T265	1390.6	146-C	28	T267	1608.0	201-C	30
T174	1047.7	110-C	14	T900	992	124-C	26	T319	1390	146-C	28	T295	1608.0	201-C	30
T108	1047.7	110-C	15	T230	1181.1	124-C	29	T197	1176.0	147-C	19	T320	1608	201-C	32
T293	1047.7	110-C	18	T163	1190.6	125-C	20	T133	1176.0	147-C	25	T255	1616.0	202-C	30
T324	881	110-C	22	T266	1000.0	125-C	22	T292	1176.0	147-C	25	T315	1656.0	207-C	32
T134	1047.7	110-C	25.4	T184	1190.6	125-C	26	T042	1409.7	148-T	19	T190	1672.0	209-C	34
T203	1057.3	111-C	17	T114	1200.1	126-T	23.8	T068	1409.7	148-T	19	T172	1688.0	211-C	30
T121	1057.3	111-T	19	T132	1200.1	126-C	23.8	T1502	1184	148-C	20	T254	1688.0	211-C	30
T081	1057.3	111-C	20	T247	1200.1	126-C	26	T252	1409.7	148-C	23	T257	1688.0	211-C	32
T709	1057.27	111-CM	25	T1565	1200.15	126-CM	27	T334	1184	148-C	23	T298	1688.0	211-C	34
T045	1057.3	111-T	25.4	T136	1016.0	127-C	24	T103	1184.0	148-C	25.4	T220	1744.0	218-C	31.8
T278	1057.3	111-C	25.4	T216	1209.7	127-C	24	T156	1409.7	148-C	25.4	T109	2086.0	219-T	25.4
T118	896.0	112-C	17	T233	1016.0	127-C	24	T139	1419.2	149-C	25.4	T110	2086.0	219-C	25.4
T162	896.0	112-C	19	T131	1043.9	127-C	25	T306	1200.0	150-C	23	T196	2086.0	219-C	25.4
T244	1066.8	112-C	24	T335	1210	127-C	25	T246	1428.7	150-C	29	T304	1784.0	223-C	27
T177	896.0	112-C	25	T079	1209.7	127-T	25.4	T137	1208.0	151-C	19	T307	1784.0	223-C	27
T245	1066.8	112-C	29	T310	1209.7	127-C	25.4	T225	1208.0	151-C	19	T221	1784.0	223-C	31.8
T189	1076.3	113-C	17	T106	1052.2	128-C	25	T165	1438.3	151-C	29	T250	1800.0	225-C	30
T065	1076.3	113-T	19	T034	1219.2	128-T	25.4	T291	1216.0	152-C	25	T285	1800.0	225-C	30
T112	1076.3	113-C	19	T208	1024.0	128-C	26	T270	1447.8	152-C	28	T180	1824.0	228-C	31.8
T176	1076.3	113-C	19	T1284	1242	128-CM	27	T317	1224.0	153-C	25	T251	1824.0	228-C	31.8
T211	1076.3	113-C	21	T015	1228.7	129-T	19	T1503	1457.3	153-CM	25.4	T218	1912.0	239-C	25.4
T187	1076.3	113-C	24	T014	1228.7	129-T	22.3	T167	1457.3	153-C	29	T183	1912.0	239-C	35
T284	1076.3	113-C	25.4	T210	1228.7	129-C	22.3	T302	1232.0	154-C	21.5	T231	2295.5	241-C	28
T122	1095.4	115-T	20	T130	1228.7	129-C	24	T256	1466.8	154-C	29	T209	1928.0	241-C	34
T175	920.0	115-C	25.4	T294	1228.7	129-C	25.4	T226	1240.0	155-C	24	T297	2024.0	253-C	30
T018	1104.9	116-T	19	T835	1228.72	129-C	31	T202	1240.0	155-C	32	T195	2056.0	257-C	32
T111	1104.9	116-C	19	T084	1238.2	130-C	25.4	T248	1240.0	155-C	32	T1596	2072	259-CM	32
T288	928.0	116-C	29	T276	1247.8	131-C	22.3	T126	1272.0	159-C	25.4	T253	2120.0	265-C	32
T107	1114.4	117-C	19	T258	1247.8	131-C	25.4	T169	1272.0	159-C	25.4	T328	2248	281-C	29
T236	936.0	117-C	21.1	T206	1247.8	131-C	30	T237	1272.0	159-C	25.4	T277	2248.0	281-C	30
T1086	1114.42	117-CM	22	T1558	1257.3	132-CM	26	T1094	1296	162-CM	20	T330	2248	281-C	30
T096	1114.4	117-T	25.4	T1095	1257.3	132-C	27	T091	1552.6	163-C	25.4	T207	2392.0	299-C	30
T069	1123.9	118-T	19	T029	1266.8	133-T	25.4	T1096	1552.6	163-CM	25.4				
T140	1123.9	118-C	19	T104	1266.8	133-T	25.4	T205	1304.0	163-C	25.4				
T150	944.0	118-C	22	T188	1266.8	133-C	25.4	T961	1552.57	163-CM	25.4				
T115	1133.5	119-C	19	T249	1266.8	133-C	25.4	T138	1304.0	163-C	26.7				
T299	1133.5	119-C	19	T316	1064.0	133-C	25.4	T199	1304.0	163-C	26.7				
T083	1133.5	119-T	25	T120	1276.3	134-T	25.4	T173	1562.1	164-C	23				
T171	1133.5	119-C	25	T1581	1276	134-CM	25.4	T198	1590.7	167-C	23				
T152	1133.5	119-C	25.4	T076	1276.3	134-T	30	T281	1344.0	168-C	25.4				



**Master Automotriz 2010**  
**Productos Gates \* FORMAS Y DIMENSIONES**



**Tabla de Aplicaciones de kits para  
bandas Micro-V® (Serpentín)**



Kit	Marca	Vehiculo	Motor	Años	Observaciones	Componentes
DBK050400	CHEVROLET	CAVALIER	4 CIL. 2.2 LTS.	2002-2005		2
DBK050400	CHEVROLET	HHR	4 CIL. 2.2 LTS.	2006-2007		2
DBK050400	CHEVROLET	HHR	4 CIL. 2.4 LTS.	2006-2007		2
DBK050478	CHEVROLET	ASTRA	4 CIL. 1.8 LTS.	2003-2000	C/AA Y D/H	2
DBK050570	CHEVROLET	ASTRA	4 CIL. 1.8 LTS.	2003-2000	S/AA	2
DBK050887	CHEVROLET	CAVALIER	4 CIL. 2.2 LTS.	1998-2002		3
DBK060570A	CHEVROLET	CHEVY (TODOS)	4 CIL. 1.6 L	2009-1995	SERPENTIN , S/AA	2
DBK060705	CHEVROLET	CHEVY (JOY-SWING-POP)	4 CIL. 1.6 L	2003-1995	SERPENTIN , C/AA	2
DBK060708	CHEVROLET	CHEVY C2	4 CIL. 1.6 L	2009-2004	SERPENTIN , C/AA	2
DBK060744	CHEVROLET	OPTRA	4 CIL. 2.0 LTS.	2006-2007		2
DBK060864A	CHEVROLET	MALIBU	V6 3.1 LTS.	2000-2003		3
DBK060864B	CHEVROLET	VENTURE	V6 3.4 LTS.	2000-2005		-2 3
DBK060882	CHEVROLET	MALIBU	V6 3.5 LTS.	2004-2006		3
DBK060950	CHEVROLET	BLAZER	V6 4.3 LTS.	2000-2005		3
DBK040551	CHRYSLER	PT CRUISER	4 CIL. 2.4 LTS.	2003-2007		2
DBK060806	DODGE	CARAVAN/VOYAGER	V6 3.0 LTS.	1996-2000		2
DBK060815B	DODGE	CARAVAN/VOYAGER	V6 3.0 LTS.	1991-1995		2
DBK060825	DODGE	CARAVAN/VOYAGER	V6 3.3 LTS.	2001-2007		3
DBK060825	DODGE	CARAVAN/VOYAGER	V6 3.8 LTS.	2001-2007		3
DBK060876	DODGE	RAM PICK-UP	V6 3.7 LTS.	2002-2007	1500 / 2500	2
DBK060876A	DODGE	RAM PICK-UP	V8 4.7 LTS.	2004-2007	1500 / 2500	3
DBK060882D	DODGE	RAM PICK-UP	V8 4.7 LTS.	2002-2003	1500 / 2500	3
DBK060966	DODGE	CARAVAN/VOYAGER	V6 3.3 LTS.	1996-2000	C/AA	2
DBK060966	DODGE	CARAVAN/VOYAGER	V6 3.8 LTS.	1996-2000	C/AA	2
DBK060980	DODGE	CARAVAN/VOYAGER	V6 3.3 LTS.	1991-1995	S/AA	2
DBK060988	DODGE	CARAVAN/VOYAGER	V6 3.3 LTS.	1996-2000	S/AA	2
DBK060988	DODGE	CARAVAN/VOYAGER	V6 3.8 LTS.	1996-2000	S/AA	2
DBK060990	DODGE	CARAVAN/VOYAGER	V6 3.3 LTS.	1991-1995	C/AA	2
DBK081102	DODGE	RAM 4000	V6 5.9 LTS. Diesel	2003-2007	S/AA	2



**Master Automotriz 2010**  
**Productos Gates \* FORMAS Y DIMENSIONES**

Kit	Marca	Vehiculo	Motor	Años	Observaciones	Componentes
DBK081265	DODGE	RAM 4000	V6 5.9 LTS. Diesel	2003-2007	C/AA	2
DBK060507	FORD	ESCORT	4 CIL. 2.0 LTS.	1997-2000	SOHC C/AA	3
DBK060532	FORD	FOCUS	4 CIL. 2.0 LTS.	2000-2002	SOHC S/AA	2
DBK060623	FORD	CONTOUR	V6 2.5 LTS.	1995-2000	S/AA	2
DBK060667	FORD	FOCUS	4 CIL. 2.0 LTS.	2003-2004	SOHC C/AA	2
DBK060670	FORD	IKON , K Y FIESTA	4 CIL. 1.6 LTS.	2007-2000	S/AA	2
DBK060680	FORD	FOCUS	4 CIL. 2.0 LTS.	2000-2002	SOHC C/AA	2
DBK060682	FORD	CONTOUR	4 CIL. 2.0 LTS.	1995-1997	S/AA	3
DBK060695	FORD	RANGER	4 CIL. 2.3 LTS.	1995-1997	S/AA	2
DBK060721	FORD	CONTOUR	V6 2.5 LTS.	1995-2000	C/AA	2
DBK060721B	FORD	RANGER	4 CIL. 2.3 LTS.	1992-1994	S/AA	2
DBK060730	FORD	RANGER	4 CIL. 2.3 LTS.	2001-2006	S/AA	2
DBK060733	FORD	CONTOUR	4 CIL. 2.0 LTS.	1995-1997	C/AA	3
DBK060775	FORD	FOCUS	4 CIL. 2.0 LTS.	2000-2002	DOHC S/AA	2
DBK060802	FORD	CONTOUR	4 CIL. 2.0 LTS.	1998-2000	S/AA	2
DBK060806B	FORD	AEROSTAR	V6, 3.0 LTS.	1995-1997	S/AA	3
DBK060810	FORD	AEROSTAR	V6, 4.0 LTS.	1990-1995	S/AA	3
DBK060820	FORD	RANGER	4 CIL. 2.3 LTS.	1995-1997	C/AA	2
DBK060820A	FORD	WINDSTAR	V6, 3.0 LTS.	1995-2000	S/AA	3
DBK060820C	FORD	ESCAPE	4 CIL. 2.3 LTS.	2001-2004	C/AA	2
DBK060827	FORD	FOCUS	4 CIL. 2.0 LTS.	2003-2004	DOHC C/AA	2
DBK060827	FORD	CONTOUR	4 CIL. 2.0 LTS.	1998-2000	C/AA	2
DBK060827B	FORD	RANGER	4 CIL. 2.3 LTS.	2001-2006	C/AA	2
DBK060837	FORD	FOCUS	4 CIL. 2.0 LTS.	2000-2002	DOHC C/AA	2
DBK060837B	FORD	RANGER	4 CIL. 2.3 LTS.	1992-1994	C/AA	2
DBK060840	FORD	ESCAPE	4 CIL. 2.3 LTS.	2005-2006		2
DBK060849	FORD	WINDSTAR	V6, 3.0 LTS.	1995-2000	C/AA	3
DBK060854	FORD	ESCORT	4 CIL. 2.0 LTS.	1997-2000	DOHC	3
DBK060864C	FORD	AEROSTAR	V6, 4.0 LTS.	1995-1997	C/AA	3
DBK060868B	FORD	AEROSTAR	V6, 4.0 LTS.	1990-1995	C/AA	3
DBK060882E	FORD	IKON , K Y FIESTA	4 CIL. 1.6 LTS.	2007-2000	C/AA	2
DBK060960	FORD	FREESTAR	V6, 3.9 LTS.	2004-2007		2
DBK060960A	FORD	WINDSTAR	V6, 3.8 LTS.	1999-2003		3
DBK061066	FORD	AEROSTAR	V6, 3.0 LTS.	1995-1997	C/AA	3
DBK060458	HONDA	ODYSSEY	V6, 3.5 LTS.	1999-2004		2
DBK060461	HONDA	ACCORD	V6, 3.0 LTS.	1998-2002	ALT. / AA	2
DBK060750	JEEP	WRANGLER	6 CIL. 4.0 L	2005-2003	SERPENTIN , S/AA	3





**Master Automotriz 2010**  
**Productos Gates \* FORMAS Y DIMENSIONES**

Kit	Marca	Vehiculo	Motor	Años	Observaciones	Componentes
DBK060750A	JEEP	WRANGLER	V-6, 4.0 L	2004-2004	SERPENTIN , S/AA	3
DBK060790	JEEP	WRANGLER	6 CIL, 4.0 L	2002-1999	SERPENTIN, S/AA	2
DBK060815	JEEP	GRAND CHEROKEE	V-8, 6.1 LTS.	2006-2007	SERPENTIN, C/AA	3
DBK060820B	JEEP	GRAND CHEROKEE	V-8, 5.7 LTS.	2005-2007	SERPENTIN, C/AA	3
DBK060868	JEEP	LIBERTY	V-6, 3.7 L	2004-2006	SERPENTIN	2
DBK060868A	JEEP	GRAND CHEROKEE	V-8, 4.7 L	2004-2007	SERPENTIN, C/AA	3
DBK060868A	JEEP	GRAND CHEROKEE	6 CIL, 3.7 LTS.	2005-2007	SERPENTIN, C/AA	3
DBK060874	JEEP	LIBERTY	V-6, 3.7 L	2002-2003	SERPENTIN, C/AA	2
DBK060874A	JEEP	GRAND CHEROKEE 4 X 4	V-8, 4.7 L	1999-2003	SERPENTIN, C/AA	3
DBK060882A	JEEP	GRAND CHEROKEE	6 CIL, 4.0 L	1999-2004	SERPENTIN, S/AA	3
DBK060882C	JEEP	WRANGLER	6 CIL, 4.0 L	2005-2000	SERPENTIN , C/AA	3
DBK060882C	JEEP	WRANGLER	V-6, 4.0 L	2004-2004	SERPENTIN , C/AA	3
DBK060919	JEEP	WRANGLER	4 CIL, 2.4 L	2004-2003	SERPENTIN, C/AA	3
DBK060755	LINCOLN	LINCOLN CONTINENTAL	V-8, 4.6 L	2002-1998	SERPENTIN	2
DBK060975	LINCOLN	MARK VIII	V-8, 4.6 L	1998-1998	SERPENTIN	3
DBK060975	LINCOLN	TOWN CAR	V-8, 4.6 L	1999-1999	SERPENTIN	3
DBK060984	LINCOLN	NAVIGATOR	V-8, 5.4 L	2002-2002	SERPENTIN	3
DBK070855	LINCOLN	LINCOLN TOWN CAR	V-8, 4.6 L	1992-1991	SERPENTIN	3
DBK080981	LINCOLN	NAVIGATOR	V-8, 5.4 L	2001-2001	SERPENTIN	3
DBK080981	LINCOLN	NAVIGATOR	V-8, 5.4 L	2000-1998	SERPENTIN, C/AA, C/DH	3
DBK060942	MERCEDES BENZ	CLK430	V-8, 4.3 L	2002-1999	SERPENTIN	2
DBK060942	MERCEDES BENZ	CLK55	V-8, 5.5 L	2001-2001	SERPENTIN	2
DBK060942	MERCEDES BENZ	E320	V-6, 3.2 L	2002-1998	SERPENTIN	2
DBK060942	MERCEDES BENZ	E430	V-8, 4.3 L	2001-1999	SERPENTIN	2
DBK060942	MERCEDES BENZ	E55	V-8, 5.5 L	2001-1999	SERPENTIN	2
DBK060942	MERCEDES BENZ	ML	V-6, 3.2 L	1998-1998	SERPENTIN	2
DBK060942	MERCEDES BENZ	ML430	V-8, 4.3 L	2001-1999	SERPENTIN	2
DBK060942	MERCEDES BENZ	ML55	V-8, 5.5 L	2001-2000	SERPENTIN	2
DBK060942	MERCEDES BENZ	S430	V-8, 4.3 L	2002-2000	SERPENTIN	2
DBK060942	MERCEDES BENZ	S500	V-8, 5.0 L	2001-1999	SERPENTIN	2
DBK060942	MERCEDES BENZ	S500 L	V-8, 5.0 L	2000-1998	SERPENTIN	2
DBK060942	MERCEDES BENZ	S55	V-8, 5.5 L	2001-2001	SERPENTIN	2
DBK060942	MERCEDES BENZ	C240	V-6, 2.6 L	2002-2001	SERPENTIN	2
DBK060942	MERCEDES BENZ	C280T	V-6, 2.8 L	1998-1998	SERPENTIN	2
DBK060942	MERCEDES BENZ	C320	V-6, 3.2 L	2001-2001	SERPENTIN	2
DBK060942	MERCEDES BENZ	CL500	V-8, 5.0 L	2001-1999	SERPENTIN	2
DBK060942	MERCEDES BENZ	CL55	V-8, 5.5 L	2001-2001	SERPENTIN	2





## Master Automotriz 2010

### Productos Gates \* FORMAS Y DIMENSIONES

Kit	Marca	Vehiculo	Motor	Años	Observaciones	Componentes
DBK060942A	MERCEDES BENZ	ML320	V-6, 3,2 L	2002-1999	SERPENTIN	3
DBK060942A	MERCEDES BENZ	SL500	V-8, 5,0 L	2001-1999	SERPENTIN	3
DBK060942A	MERCEDES BENZ	C280	V-6, 2,8 L	1999-1998	SERPENTIN	3
DBK060942A	MERCEDES BENZ	C43	V-8, 4,3 L	2000-1999	SERPENTIN	3
DBK060942A	MERCEDES BENZ	CLK320	V-6, 3,2 L	2002-1999	SERPENTIN	3
DBK060623A	MERCURY	MYSTIQUE	V-6, 2,5 L, DURATEC, DOHC	2000-1995	SERPENTIN, S/AA	3
DBK060682	MERCURY	MYSTIQUE	4 CIL, 2,0 L, ZETEC, DOHC	1997-1996	SERPENTIN, S/AA	3
DBK060716	MERCURY	MYSTIQUE	V-6, 2,5 L, DURATEC, DOHC	2000-1995	SERPENTIN, C/AA	3
DBK060721A	MERCURY	MYSTIQUE	V-6, 2,5 L, DURATEC, DOHC	2000-1997	SERPENTIN, C/AA	3
DBK060733	MERCURY	MYSTIQUE	4 CIL, 2,0 L, ZETEC, DOHC	1997-1996	SERPENTIN, C/AA	3
DBK060802A	MERCURY	MYSTIQUE	4 CIL, 2,0 L, ZETEC, DOHC	2000-1999	SERPENTIN, S/AA	3
DBK060815C	MERCURY	SABLE	V-6, 3,0 L	2003-2001	SERPENTIN , C/AA 24V.	2
DBK060827A	MERCURY	MYSTIQUE	4 CIL, 2,0 L, ZETEC, DOHC	2000-1999	SERPENTIN, C/AA	3
DBK060832	MERCURY	MYSTIQUE	4 CIL, 2,0 L, ZETEC, DOHC	1998-1998	SERPENTIN, C/AA >FEB 1998	3
DBK060854A	MERCURY	SABLE	V-6, 3,0 L, OHV	2000-1999	SERPENTIN 12 V.	3
DBK060854A	MERCURY	SABLE	V-6, 3,0 L, DURATEC, DOHC	1999-1999	SERPENTIN, C/AA	3
DBK060854B	MERCURY	SABLE	V-6, 3,0 L, OHV	2000-2000	SERPENTIN	3
DBK060858	MERCURY	SABLE	V-6, 3,0 L, OHV	2002-2001	SERPENTIN, S/motor HV	2
DBK060858	MERCURY	SABLE	V-6, 3,0 L, DURATEC, SOHC	1998-1998	SERPENTIN OHV	2
DBK060858	MERCURY	SABLE LS	V-6, 3,0 L, DURATEC, OVH	2001-2000	SERPENTIN	2
DBK060858A	MERCURY	MYSTIQUE	4 CIL, 2,0 L, ZETEC, DOHC	1998-1998	SERPENTIN, C/AA, < ENE	3
DBK060975	MERCURY	GRAND MARQUIS	V-8, 4,6 L	1999-1995	SERPENTIN	3
DBK070855	MERCURY	GRAND MARQUIS	V-8, 4,6 L	1994-1992	SERPENTIN, ALT. C/86 3/8"	3
DBK050435	NISSAN	PLATINA	4 CIL, 1,6 L	2002-2008	S/AA	2
DBK050688	NISSAN	PLATINA	4 CIL, 1,6 L	2002-2008	c/AA	2
DBK060883	NISSAN	ALTIMA	4 CIL, 2,4 L	2004-2003	SERPENTIN	2
DBK060883	NISSAN	SENTRA	4 CIL, 2,5 L	2004-2003	SERPENTIN	2
DBK060695B	OLDSMOBILE	SILHOUETTE	V-6, 3,1 L	1993-1992	SERPENTIN	2
DBK060938	OLDSMOBILE	LSS	V-6, 3,8 L	1999-1999	SERPENTIN	2
DBK061025	OLDSMOBILE	SILHOUETTE	V-6, 3,8 L	1994-1993	SERPENTIN, ALT.105 Amp	2
DBK060420	PEUGEOT	306	4 CIL, 2,0 L, XU10J4R	2001-1999	SERPENTIN, S/AA	2
DBK060425B	PEUGEOT	306	4 CIL, 1,8 L, XU7JP4	2001-1999	SERPENTIN, S/AA	2
DBK060570	PEUGEOT	206	4 CIL, 1,6 L, TU5JP4	2001-1999	SERPENTIN, S/AA	2
DBK060615	PEUGEOT	206	4 CIL, 1,4 L	2004-1999	SERPENTIN, C/AA & C/DH	2
DBK060615	PEUGEOT	206	4 CIL, 1,6 L	2004-1999	SERPENTIN, C/AA & C/DH	2
DBK060630	PEUGEOT	306	4 CIL, 2,0 L, XU10J4R	2001-1999	SERPENTIN, C/AA	2
DBK060653	PEUGEOT	306	4 CIL, 1,8 L, XU7JP4	2001-1999	SERPENTIN, C/AA	3



**Master Automotriz 2010**  
**Productos Gates \* FORMAS Y DIMENSIONES**

Kit	Marca	Vehiculo	Motor	Años	Observaciones	Componentes
DBK040410	PONTIAC	TRANS AM FIREBIRD	V-8, 5.7 L	2001-1998	SERPENTIN, A.A.	2
DBK050345	PONTIAC	SUNFIRE	4 CIL, 2.2 L	2004-2004	SERPENTIN S/AA	3
DBK050345	PONTIAC	G5	4-Cyl. 2.4 L	2005-2007	S/AA	3
DBK050400	PONTIAC	SUNFIRE	4 CIL. 2.2 LTS.	2002-2005		2
DBK050400A	PONTIAC	SUNFIRE	4 CIL, 2.2 L	2005-2005	SERPENTIN	3
DBK050400A	PONTIAC	SUNFIRE	4 CIL, 2.2 L, MOTOR # SERIE F	2002-2002	SERPENTIN, C/AA; Motor # serie F	3
DBK050400A	PONTIAC	SUNFIRE	4 CIL, 2.2 L	2004-2004	SERPENTIN C/AA	3
DBK050400A	PONTIAC	G5	4-Cyl. 2.2 L	2005-2007	C/AA	3
DBK050405	PONTIAC	G6	4-Cyl. 2.4 L	2005-2007		3
DBK050474	PONTIAC	SUNFIRE	4 CIL, 2.4 L, MFI PRIMER DISEÑO	1999-1996	SERPENTIN	3
DBK050630	PONTIAC	SUNFIRE	4 CIL, 2.2 L	2002-1998	SERPENTIN, S/AA; Motor # de serie 4	3
DBK050705	PONTIAC	SUNFIRE	4 CIL, 2.2 L, MFI	1997-1995	SERPENTIN, S/AA	3
DBK050835	PONTIAC	SUNFIRE	4 CIL, 2.2 L, MFI	1997-1995	SERPENTIN, C/AA	3
DBK050887	PONTIAC	SUNFIRE	4 CIL, 2.2 L, MOTOR SERIE 4	2002-1998	SERPENTIN, C/AA; Motor serie 4	3
DBK050887	PONTIAC	SUNFIRE	4 CIL, 2.2 LTS.	1998-2002		3
DBK060642	PONTIAC	TRANS AM FIREBIRD	V-8, 5.7 L	1997-1995	SERPENTIN	2
DBK060721C	PONTIAC	BONNEVILLE SSE	V-6, 3.8 L	1999-1998	SERPENTIN - SUPERCARGADOR	3
DBK060790B	PONTIAC	TRANS AM FIREBIRD	V-8, 5.7 L	2001-1998	SERPENTIN ACCESORIOS	2
DBK060864	PONTIAC	AZTEK	V-6, 3.4 L	2005-2001	SERPENTIN	2
DBK060864B	PONTIAC	MONTANA	V-6 3.4 L	2005-2003	C/105A ALT.	3
DBK060875	PONTIAC	MONTANA	V-6 3.4 L	2005-2003	C/130A ALT.	3
DBK060888	PONTIAC	MONTANA	V-6 3.5 L	2006-2005		3
DBK060905	PONTIAC	TORRENT	V-6 3.4 L	2006-2006		3
DBK060935	PONTIAC	G6	V-6 3.6 L	2007-2007		3
DBK060938A	PONTIAC	BONNEVILLE SSE	V-6, 3.8 L	1999-1998	SERPENTIN	3
DBK050435	RENAULT	CLIO / KANGOO	4 CIL, 1.6 L	2002-2008	S/AA	2
DBK050688	RENAULT	CLIO / KANGOO	4 CIL, 1.6 L	2002-2008	c/AA	2
DB6DPK1200	SEAT	LEON	4 CIL, 1.8 L, TURBO	2003-2003	SERPENTIN , ALT., C/AA	2
DB6DPK1200	SEAT	TOLEDO	4 CIL, 1.8 L	2003-2003	SERPENTIN , ALT., C/AA	2
DBK060295	SEAT	IBIZA	4 CIL, 1.6L	2005-2003	SERPENTIN , S/AA, C/DH	2
DBK060365	SEAT	IBIZA	4 CIL, 2.0 L	2005-2003	SERPENTIN , S/AA	2
DBK060367	SEAT	CORDOBA	4 CIL, 2.0 L	2004-2004	SERPENTIN , ALT. S/AA	2
DBK060406	SEAT	IBIZA	4 CIL, 2.0 L	2005-2003	SERPENTIN , C/AA	2
DBK060408	SEAT	CORDOBA	4 CIL, 2.0 L	2004-2004	SERPENTIN , ALT. C/AA	2
DBK060425	SEAT	CORDOBA	4 CIL, 1.6 L	2005-2001	SERPENTIN , ALT. C/AA	2
DBK060425	SEAT	IBIZA	4 CIL, 1.6L	2005-2003	SERPENTIN , C/AA, C/DH	2
DBK060445	SEAT	LEON	4 CIL, 1.8 L, TURBO	2003-2003	SERPENTIN , ALT., S/AA	2



## Master Automotriz 2010

### Productos Gates \* FORMAS Y DIMENSIONES

Kit	Marca	Vehiculo	Motor	Años	Observaciones	Componentes
DBK060445	SEAT	TOLEDO	4 CIL, 1.8 L	2003-2003	SERPENTIN , ALT., S/AA	2
DB6DPK1200	VOLKSWAGEN	SHARAN	4 CIL, 1.8 L	2003-2006	SERPENTIN , C/AA	2
DB6DPK1200A	VOLKSWAGEN	BEETLE	4 CIL, 1.8 L	2005-2000	SERPENTIN, C/AA, C/BANDA DE DOBLE PERFIL	3
DB6DPK1200A	VOLKSWAGEN	BEETLE	4 CIL, 2.0 L	2005-2000	SERPENTIN , C/AA	3
DB6DPK1200A	VOLKSWAGEN	GOLF	4 CIL, 1.8 L, TURBO	2005-2001	SERPENTIN , C/AA	3
DB6DPK1200A	VOLKSWAGEN	GOLF	4 CIL, 2.0 L	2005-2000	SERPENTIN, C/AA	3
DB6DPK1200A	VOLKSWAGEN	JETTA	4 CIL, 1.8 L	2005-2000	SERPENTIN	3
DB6DPK1200A	VOLKSWAGEN	JETTA	4 CIL, 2.0 L	2005-1999	SERPENTIN , C/AA	3
DB7DPK1360	VOLKSWAGEN	JETTA	V-6, 2.8 L	2004-1999	SERPENTIN, C/BANDA DE DOBLE PERFIL, C/7 COSTILLAS	2
DBK050510	VOLKSWAGEN	PASSAT	4 CIL, 1.8 L, DOHC TURBO	2005-1999	SERPENTIN , P/ALT, DIR. HIDR. Y VENT.	3
DBK060297	VOLKSWAGEN	POLO	4 CIL, 1.6 L	2003-2006	SERPENTIN, S/AA	2
DBK060355	VOLKSWAGEN	CABRIO	4 CIL, 2.0 L, MPFI	1995-1995	SERPENTIN, ALT. & B.A. S/AA, S/ALT. 120A	3
DBK060365B	VOLKSWAGEN	PANEL	4 CIL, 1.8 L	2001-1996	SERPENTIN, ALT., C/RAD	2
DBK060385	VOLKSWAGEN	CABRIO	4 CIL, 2.0 L, MPFI	2002-1995	SERPENTIN, B.A. & ALT., S/AA	3
DBK060385	VOLKSWAGEN	GOLF	4 CIL, 2.0 L, MPFI	2000-1999	BANDA B.A. & ALT., S/AA; S/BANDA DE DOBLE PERFIL	3
DBK060385	VOLKSWAGEN	JETTA	4 CIL, 2.0 L	1994-1994	SERPENTIN, ALT. & B.A. S/AA, C/ALT 120A	3
DBK060385	VOLKSWAGEN	JETTA	4 CIL, 2.0 L	2000-1999	SERPENTIN, ALT. & B.A. S/AA	3
DBK060406	VOLKSWAGEN	POLO	4 CIL, 2.0 L	2003-2006	SERPENTIN , C/AA	2
DBK060408A	VOLKSWAGEN	JETTA	4 CIL, 2.0 L	2000-1996	SERPENTIN, ALT., S/AA, S/DH	3
DBK060420B	VOLKSWAGEN	LUPO	4 CIL, 1.6 L	2006-2004	SERPENTIN, C/DH Y S/AA	2
DBK060424	VOLKSWAGEN	POLO	4 CIL, 1.6 L	2003-2006	SERPENTIN, C/AA	2
DBK060441	VOLKSWAGEN	GOLF	4 CIL, 2.0 L	2005-2003	SERPENTIN , S/AA	3
DBK060454	VOLKSWAGEN	CABRIO GL, GLS	4 CIL, 2.0 L, MPFI	2000-2000	SERPENTIN, ALT., C/AA, C/DH	3
DBK060455	VOLKSWAGEN	CABRIO	4 CIL, 2.0 L, MPFI	2002-1995	BANDA ALT. & A.A.	3
DBK060455	VOLKSWAGEN	JETTA	4 CIL, 2.0 L	2000-2000	BANDA ALT. & A.A., S/MICRO V DE DOBLE PERFIL	3
DBK060455B	VOLKSWAGEN	VW VAN	4 CIL, 1.6 L	2003-2006	SERPENTIN , C/AA	2
DBK060669	VOLKSWAGEN	LUPO	4 CIL, 1.6 L	2006-2004	SERPENTIN, C/DH Y C/AA	2
DBK060683	VOLKSWAGEN	POINTER	4 CIL, 1.8 L	2001-2008	SERPENTIN, ALT., S/AA	2
DBK060683	VOLKSWAGEN	POINTER PICK-UP	4 CIL, 1.8 L	2005-2008	SERPENTIN, S/AA	2
DBK060739	VOLKSWAGEN	JETTA	V-6, 2.8 L	2002-2002	SERPENTIN, S/AA	2
DBK060894	VOLKSWAGEN	POINTER	4 CIL, 1.8 L, MFI	2001-2008	SERPENTIN, C/AA, C/DH	2
DBK060894	VOLKSWAGEN	POINTER PICK-UP	4 CIL, 1.8 L, MFI	2001-1999	SERPENTIN, C/AA, C/DH	2
DBK060894	VOLKSWAGEN	POINTER STATION WAGON	4 CIL, 1.8 L, MFI	2001-1999	SERPENTIN, C/AA, C/DH	2



Master Automotriz 2010  
Productos Gates \* FORMAS Y DIMENSIONES

**Kits para bandas Micro-V® DriveAlign®**

Componentes iguales a los de equipo original:

- Tensor con resorte helicoidal DriveAlign®, eliminan el ruido, la vibración y el desgaste de la transmisión.



- Banda Micro-V® AT con la mejor tecnología del mercado (Más silenciosa y mayor duración).





**Master Automotriz 2010**  
**Productos Gates \* FORMAS Y DIMENSIONES**



**Tabla de Aplicaciones de kits  
para PowerGrip®**



Kit	Marca	Vehículo	Motor	Años	Observaciones	Componentes
TCK184	ACURA	INTEGRA	4 CIL, 1.8 L	1999-2001		2
TCK193	ACURA	TL	V-6, 3.2 L	1998-1998		2
TCK247	ACURA	INTEGRA	4 CIL, 1.8 L	2001-1999	C/VTEC MOTOR.	2
TCK286	ACURA	TL	V-6, 3.2 L	2000-1999		3
TCK244	ACURA	CL	4 CIL, 2.3 L	1998-1999		4
TCK297	AUDI	A8	V-8, 4.2 L	2007-2007		3
TCK285	CADILLAC	CATERA	V-6, 3.0 L	1998-1999		4
TCK285A	CADILLAC	CATERA	V-6, 3.0 L	2000-1999	Late	4
TCK1022	CHEVROLET	ASTRA	4 CIL, 2.0 L	2004-2005		2
TCK1022	CHEVROLET	ZAFIRA	4 CIL, 2.0 L	2005-2006		2
TCK164	CHEVROLET	TRACKER	4 CIL, 1.6 L	1991-1992		2
TCK212	CHEVROLET	TRACKER	4 CIL, 1.6 L	2001-2002		2
TCK305	CHEVROLET	ASTRA	4 CIL, 2.4 L	2006-2004		2
TCK305	CHEVROLET	ZAFIRA	4 CIL, 2.4 L	2006-2004		2
TCK203	CHEVROLET	CHEVY	4 CIL, 1.6 L	1999-1997		3
TCK203	CHEVROLET	CHEVY C2	4 CIL, 1.6 L	2007-2004		3
TCK203	CHEVROLET	CHEVY C2 SEDAN	4 CIL, 1.6 L	2007-2006		3
TCK203	CHEVROLET	CHEVY JOY	4 CIL, 1.6 L	2000-1998		3
TCK203	CHEVROLET	CHEVY PICK-UP	4 CIL, 1.6 L	2002-2004		3
TCK203	CHEVROLET	CHEVY POP	4 CIL, 1.6 L	1998-1996		3
TCK203	CHEVROLET	CHEVY SWING	4 CIL, 1.6 L	2000-1997		3
TCK203	CHEVROLET	MONZA	4 CIL, 1.6 L	2002-1994		3
TCK192	CHEVROLET	LUMINA	V-6, 3.4 L	1993-1991		4
TCK273	CHEVROLET	LUMINA	V-6, 3.4 L	1996-1997		4
TCK1094	CHEVROLET	ASTRA	4 CIL, 1.8 L	2000-2003		4
TCK1094	CHEVROLET	ZAFIRA	4 CIL, 1.8 L	2003-2001		4
TCK309	CHEVROLET	OPTRA	4 CIL, 2.0 L	2008-2006		4
TCK139	CHRYSLER	DAYTONA	V-6, 3.0 L	1993-1990		2
TCK139	CHRYSLER	GRAND VOYAGER	V-6, 3.0 L	1996-2001		2
TCK139	CHRYSLER	GRAND VOYAGER	V-6, 3.3 L	2000-2000		2
TCK139	CHRYSLER	LEBARON	V-6, 3.0 L	1991-1990		2



**Master Automotriz 2010**  
**Productos Gates \* FORMAS Y DIMENSIONES**

Kit	Marca	Vehiculo	Motor	Años	Observaciones	Componentes
TCK139	CHRYSLER	TOWN & COUNTRY VAN	V-6, 3.0 L	1990-1990		2
TCK139	CHRYSLER	VOYAGER	V-6, 3.0 L	1997-2000		2
TCK153	CHRYSLER	DAYTONA	4 CIL, 2.2 L	1990-1990		2
TCK153	CHRYSLER	DAYTONA	4 CIL, 2.5 L	1990-1993		2
TCK153	CHRYSLER	LEBARON	4 CIL, 2.2 L	1990-1990		2
TCK153	CHRYSLER	LEBARON	4 CIL, 2.5 L	1993-1992		2
TCK219	CHRYSLER	CONCORDE	V-6, 3.5 L	1993-1994		2
TCK219	CHRYSLER	INTREPID	V-6, 3.5 L	1994-1993		2
TCK219	CHRYSLER	LHS	V-6, 3.5 L	1994-1994		2
TCK219	CHRYSLER	NEW YORKER	V-6, 3.5 L	1994-1994		2
TCK245	CHRYSLER	CIRRUS	4 CIL, 2.0 L	2000-2000	C/Hyd. TENSOR	2
TCK255	CHRYSLER	CONCORDE	V-6, 3.5 L	1997-1995		2
TCK255	CHRYSLER	INTREPID	V-6, 3.5 L	1997-1995		2
TCK255	CHRYSLER	LHS	V-6, 3.5 L	1995-1997		2
TCK255	CHRYSLER	NEW YORKER	V-6, 3.5 L	1995-1996		2
TCK295	CHRYSLER	300M	V-6, 3.5 L	2002-1999		2
TCK295	CHRYSLER	CONCORDE	V-6, 3.2 L	2001-2000		2
TCK295	CHRYSLER	CONCORDE	V-6, 3.5 L	2002-2002		2
TCK295	CHRYSLER	INTREPID	V-6, 3.2 L	1999-1998		2
TCK295	CHRYSLER	INTREPID	V-6, 3.5 L	2000-2001		2
TCK295	CHRYSLER	LHS	V-6, 3.5 L	2000-1999		2
TCK246	CHRYSLER	SEBRING	4 CIL, 2.0 L	1995-1999	C/DOHC MOTOR.; C/Hyd. TENSOR	3
TCK259	CHRYSLER	CIRRUS	V-6, 2.5 L	1998-1999		3
TCK259	CHRYSLER	SEBRING	V-6, 2.5 L	1998-1997		3
TCK259	CHRYSLER	SEBRING	V-6, 3.0 L	2004-2001		3
TCK139	DODGE	CARAVAN	V-6, 3.0 L	1993-1995		2
TCK139	DODGE	GRAND CARAVAN	V-6, 3.0 L	1992-2001		2
TCK139	DODGE	SPIRIT	V-6, 3.0 L	1995-1994		2
TCK153	DODGE	CARAVAN	4 CIL, 2.5 L	1995-1995		2
TCK153	DODGE	DAKOTA	4 CIL, 2.5 L	1995-1995		2
TCK153	DODGE	SHADOW	4 CIL, 2.2 L	1994-1994		2
TCK153	DODGE	SHADOW	4 CIL, 2.5 L	1994-1994		2
TCK153	DODGE	SPIRIT	4 CIL, 2.5 L	1994-1995		2
TCK245	DODGE	NEON	4 CIL, 2.0 L	1996-2002	C/Hyd. TENSOR	2
TCK245	DODGE	STRATUS	4 CIL, 2.0 L	1995-2000		2
TCK255	DODGE	INTREPID	V-6, 3.5 L	1996-1997		2
TCK295	DODGE	INTREPID	V-6, 3.2 L	1998-2001		2





**Master Automotriz 2010**  
**Productos Gates \* FORMAS Y DIMENSIONES**

Kit	Marca	Vehiculo	Motor	Años	Observaciones	Componentes
TCK295	DODGE	INTREPID	V-6, 3.5 L	2000-2002		2
TCK246	DODGE	NEON	4 CIL, 2.0 L	1998-1999	C/DOHC MOTOR.; C/Hyd. TENSOR	3
TCK259	DODGE	STRATUS	V-6, 2.5 L	1997-1999		3
TCK259	DODGE	STRATUS	V-6, 3.0 L	2004-2001		3
TCK194	FORD	ESCORT	4 CIL, 1.9 L	1996-1994		2
TCK210	FORD	RANGER	4 CIL, 2.3 L	1994-1994		2
TCK276	FORD	RANGER	4 CIL, 2.3 L	1995-2001		2
TCK276	FORD	RANGER	4 CIL, 2.5 L	2001-2000		2
TCK283	FORD	ESCORT	4 CIL, 2.0 L	1998-1997		2
TCK283	FORD	FOCUS	4 CIL, 2.0 L	2004-2001		2
TCK179	FORD	ESCORT	4 CIL, 1.8 L	1996-1994		3
TCK283	FORD	ESCORT	4 CIL, 2.0 L	2002-1997	C/SOHC MOTOR.	3
TCK294B	FORD	ESCAPE	4 CIL, 2.0 L	2002-2004		3
TCK258	FORD	CONTOUR	4 CIL, 2.0 L	1997-1995		4
TCK294	FORD	CONTOUR	4 CIL, 2.0 L	1998-1999		4
TCK294	FORD	ESCORT	4 CIL, 2.0 L	1998-2000		4
TCK294A	FORD	CONTOUR	4 CIL, 2.0 L	1999-2000		4
TCK294A	FORD	ESCORT	4 CIL, 2.0 L	2000-1999		4
TCK294A	FORD	FOCUS	4 CIL, 2.0 L	2000-2006		4
TCK294A	FORD	ZX2	4 CIL, 2.0 L	2003-2003		4
TCK250	FORD	CONTOUR	4 CIL, 2.0 L	1997-1997	Motor de interferencia	2
TCK143	HONDA	CIVIC	4 CIL, 1.5 L	1995-1995		2
TCK143	HONDA	CIVIC DEL SOL	4 CIL, 1.5 L	1995-1995		2
TCK184	HONDA	CR-V	4 CIL, 2.0 L	2001-1999		2
TCK224	HONDA	CIVIC	4 CIL, 1.6 L	1997-1995	C/SOHC MOTOR.	2
TCK224	HONDA	CIVIC DEL SOL	4 CIL, 1.6 L	1997-1996		2
TCK227	HONDA	CIVIC	4 CIL, 1.6 L	2000-1999		2
TCK227	HONDA	CIVIC DEL SOL	4 CIL, 1.6 L	1997-1995		2
TCK221	HONDA	PASSPORT	V-6, 3.2 L	1997-1997		3
TCK286	HONDA	ACCORD	V-6, 3.0 L	2000-2001		3
TCK186	HONDA	ACCORD	4 CIL, 2.2 L	1996-1997		4
TCK186	HONDA	ODYSSEY	4 CIL, 2.2 L	1996-1997		4
TCK244	HONDA	ACCORD	4 CIL, 2.2 L	1995-1996		4
TCK244	HONDA	ACCORD	4 CIL, 2.3 L	1998-1999		4
TCK244	HONDA	ODYSSEY	4 CIL, 2.3 L	1998-1998		4
TCK1013M	HYUNDAI	ATOS	4 CIL, 1.0 L	2004-2000		2
TCK1013M	HYUNDAI	ATOS	4 CIL, 1.1 L	2008-2005		2



**Master Automotriz 2010**  
**Productos Gates \* FORMAS Y DIMENSIONES**

Kit	Marca	Vehiculo	Motor	Años	Observaciones	Componentes
TCK124M	HYUNDAI	H100	4 CIL, 2.4 L	2005-2003		2
TCK324M	HYUNDAI	ACCENT	4 CIL, 1.5 L	2003-2000		2
TCK324M	HYUNDAI	ACCENT	4 CIL, 1.6 L	2006-2001		2
TCK324M	HYUNDAI	ATTITUD	4 CIL, 1.6 L	2007-2006		2
TCK324M	HYUNDAI	ATTITUDE	4 CIL, 1.6 L	2007-2006		2
TCK324M	HYUNDAI	VERNA	4 CIL, 1.5 L	2007-2004		2
TCK324M	HYUNDAI	VERNA	4 CIL, 1.6 L	2006-2005		2
TCK282M	HYUNDAI	ACCENT	4 CIL, 1.5 L	2003-2000		3
TCK282M	HYUNDAI	ACCENT	4 CIL, 1.6 L	2006-2001		3
TCK282M	HYUNDAI	ATTITUD	4 CIL, 1.6 L	2007-2006		3
TCK282M	HYUNDAI	ATTITUDE	4 CIL, 1.6 L	2007-2006		3
TCK282M	HYUNDAI	VERNA	4 CIL, 1.5 L	2007-2004		3
TCK282M	HYUNDAI	VERNA	4 CIL, 1.6 L	2006-2005		3
TCK282M	HYUNDAI	ACCENT	4 CIL, 1.6 L	2006-2001		3
TCK179	MAZDA	MX-5 MIATA	4 CIL, 1.8 L	2005-2005		3
TCK258	MERCURY	MYSTIQUE	4 CIL, 2.0 L	1996-1997		4
TCK294	MERCURY	MYSTIQUE	4 CIL, 2.0 L	1998-1999		4
TCK294A	MERCURY	COUGAR	4 CIL, 2.0 L	1999-2003		4
TCK294A	MERCURY	MYSTIQUE	4 CIL, 2.0 L	1999-2000		4
TCK259	MITSUBISHI	ECLIPSE	V-6, 3.0 L	2005-2000		3
TCK259	MITSUBISHI	GALANT	V-6, 3.0 L	2000-2003		3
TCK259	MITSUBISHI	MONTERO SPORT	V-6, 3.0 L	2000-2003		3
TCK287	MITSUBISHI	DIAMANTE	V-6, 3.5 L	2000-2004		3
TCK287	MITSUBISHI	ENDEAVOR	V-6, 3.8 L	2006-2004		3
TCK287	MITSUBISHI	GALANT	V-6, 3.8 L	2004-2006		3
TCK287	MITSUBISHI	MONTERO	V-6, 3.5 L	2000-2000		3
TCK287	MITSUBISHI	MONTERO SPORT	V-6, 3.5 L	2000-2002		3
TCK104	NISSAN	MAXIMA	V-6, 3.0 L	1990-1994	C/Square Tooth Sprockets	2
TCK104	NISSAN	PATHFINDER	V-6, 3.0 L	1990-1991		2
TCK104	NISSAN	PICK-UP	V-6, 3.0 L	1992-1990		2
TCK104	NISSAN	QUEST	V-6, 3.0 L	1994-1993		2
TCK249	NISSAN	FRONTIER	V-6, 3.3 L	1999-2001	Motor de interferencia	2
TCK249	NISSAN	MAXIMA	V-6, 3.0 L	1994-1993		2
TCK249	NISSAN	PATHFINDER	V-6, 3.0 L	1994-1995		2
TCK249	NISSAN	PATHFINDER	V-6, 3.3 L	1996-1997		2
TCK249	NISSAN	PICK-UP	V-6, 3.0 L	1993-1995		2
TCK249	NISSAN	QUEST	6 CIL, 3.3 L	2002-2002		2



## Master Automotriz 2010

### Productos Gates \* FORMAS Y DIMENSIONES

Kit	Marca	Vehiculo	Motor	Años	Observaciones	Componentes
TCK249	NISSAN	QUEST	V-6, 3.0 L	1994-1998		2
TCK249	NISSAN	QUEST	V-6, 3.3 L	2002-2000		2
TCK249	NISSAN	XTERRA	V-6, 3.3 L	2004-2000		2
TCK1095	NISSAN	APRIO	4 CIL, 1.6 L	2008-2008		4
TCK1095	NISSAN	PLATINA	4 CIL, 1.6 L	2004-2008		4
TCK1095M	NISSAN	APRIO	4 CIL, 1.6 L	2008-2008		4
TCK1095M	NISSAN	PLATINA	4 CIL, 1.6 L	2003-2007		4
TCK1095M	NISSAN	APRIO	4 CIL, 1.6 L	2008-2008		4
TCK1095M	NISSAN	PLATINA	4 CIL, 1.6 L	2008-2002		4
TCK901	PEUGEOT	206	4 CIL, 1.4 L	2001-1998	108 Dientes y 17mm de Ancho	2
TCK901A	PEUGEOT	206	4 CIL, 1.4 L	2003-2008	104 Dientes y 17mm de Ancho	2
TCK192	PONTIAC	GRAND PRIX	V-6, 3.4 L	1995-1995		4
TCK273	PONTIAC	GRAND PRIX	V-6, 3.4 L	1996-1996		4
TCK1284	RENAULT	MEGAN I	4 CIL, 2.0 L	2001-2003		2
TCK1565	RENAULT	MEGAN II	4 CIL, 2.0 L	2005-2006		2
TCK1095M	RENAULT	CLIO	4 CIL, 1.6 L	2003-2008		4
TCK1095M	RENAULT	KANGOO	4 CIL, 1.6 L	2006-2005		4
TCK1095M	RENAULT	KANGOO EXPRESS	4 CIL, 1.6 L	2005-2007		4
TCK1095M	RENAULT	CLIO	4 CIL, 1.6 L	2008-2003		4
TCK1095M	RENAULT	KANGOO	4 CIL, 1.6 L	2008-2005		4
TCK1095M	RENAULT	KANGOO EXPRESS	4 CIL, 1.6 L	2008-2005		4
TCK285	SAAB	09-May	V6, 3.0 L	2002-2003		4
TCK285	SAAB	09-May	V-6, 3.0 L	2000-2003		4
TCK1548	SEAT	CORDOBA	4 CIL, 1.6 L	2007-2004		2
TCK1548	SEAT	IBIZA	4 CIL, 1.6 L	2006-2003		2
TCK199	TOYOTA	CAMRY	4 CIL, 2.2 L	2000-2001		3
TCK199	TOYOTA	CAMRY SOLARA	4 CIL, 2.2 L	2000-2000		3
TCK199	TOYOTA	RAV 4	4 CIL, 2.0 L	2000-2000		3
TCK199	TOYOTA	SOLARA	4 CIL, 2.2 L	2001-2001		3
TCK257	TOYOTA	AVALON	V-6, 3.0 L	2000-2004		3
TCK257	TOYOTA	CAMRY	V-6, 3.0 L	2002-2000		3
TCK257	TOYOTA	CAMRY SOLARA	V-6, 3.0 L	2000-2000		3
TCK257	TOYOTA	SIENNA	V-6, 3.0 L	2003-2002		3
TCK257	TOYOTA	SOLARA	V-6, 3.0 L	2002-2001		3
TCK271	TOYOTA	4 RUNNER	V-6, 3.4 L	2000-1997		3
TCK271	TOYOTA	T100	V-6, 3.4 L	1998-1998		3
TCK271	TOYOTA	TACOMA	V-6, 3.4 L	2001-2003		3



**Master Automotriz 2010**  
**Productos Gates \* FORMAS Y DIMENSIONES**

Kit	Marca	Vehiculo	Motor	Años	Observaciones	Componentes
TCK271	TOYOTA	TUNDRA	V-6, 3.4 L	2000-2002		3
TCK298	TOYOTA	LAND CRUISER	V-8, 4.7 L	2007-2007		3
TCK298	TOYOTA	TUNDRA	V-8, 4.7 L	2007-2008		3
TCK017	VOLKSWAGEN	GOLF	4 CIL, 1.8 L	1995-1995		2
TCK017	VOLKSWAGEN	GOLF GTI SPECIAL	4 CIL, 1.8 L	1992-1992		2
TCK017	VOLKSWAGEN	JETTA	4 CIL, 1.8 L	1990-1992		2
TCK017	VOLKSWAGEN	JETTA GL	4 CIL, 1.8 L	1991-1992		2
TCK017	VOLKSWAGEN	JETTA GLI	4 CIL, 1.8 L	1990-1991		2
TCK1548	VOLKSWAGEN	CROSSFOX	4 CIL, 1.6 L	2008-2005		2
TCK1548	VOLKSWAGEN	LUPO	4 CIL, 1.6 L	2006-2008		2
TCK1548	VOLKSWAGEN	POLO	4 CIL, 1.6 L	2007-2005		2
TCK1548	VOLKSWAGEN	SPORT VAN	4 CIL, 1.6 L	2007-2006		2
TCK1548	VOLKSWAGEN	SPORTVAN	4 CIL, 1.6 L	2008-2006		2
TCK260M	VOLKSWAGEN	CABRIO	4 CIL, 2.0 L	1995-1995		2
TCK260M	VOLKSWAGEN	CABRIO	4 CIL, 2.0 L	2002-1996		2
TCK260M	VOLKSWAGEN	DERBY	4 CIL, 1.8 L	2008-2005		2
TCK260M	VOLKSWAGEN	GOLF	4 CIL, 2.0 L	1996-1995		2
TCK260M	VOLKSWAGEN	GOLF	4 CIL, 2.0 L	1999-1999		2
TCK260M	VOLKSWAGEN	GOLF	4 CIL, 2.0 L	2000-2000		2
TCK260M	VOLKSWAGEN	GOLF	4 CIL, 2.0 L	1998-1997		2
TCK260M	VOLKSWAGEN	JETTA	4 CIL, 2.0 L	1996-1995		2
TCK260M	VOLKSWAGEN	JETTA	4 CIL, 2.0 L	1999-1999		2
TCK260M	VOLKSWAGEN	JETTA	4 CIL, 2.0 L	2000-2000		2
TCK260M	VOLKSWAGEN	JETTA	4 CIL, 2.0 L	1998-1997		2
TCK260M	VOLKSWAGEN	PASSAT	4 CIL, 2.0 L	1996-1995		2
TCK260M	VOLKSWAGEN	POINTER	4 CIL, 1.8 L	2008-1998		2
TCK262	VOLKSWAGEN	CABRIO	4 CIL, 2.0 L	1996-1995		2
TCK262	VOLKSWAGEN	GOLF	4 CIL, 2.0 L	1995-1997		2
TCK262	VOLKSWAGEN	GTI	4 CIL, 2.0 L	2000-1999		2
TCK262	VOLKSWAGEN	JETTA	4 CIL, 2.0 L	2000-1995		2
TCK262	VOLKSWAGEN	PASSAT	4 CIL, 2.0 L	1995-1996		2
TCK262A	VOLKSWAGEN	CABRIO	4 CIL, 2.0 L	1996-1996		2
TCK296	VOLKSWAGEN	BEETLE	4 CIL, 2.0 L	1998-2000	Nvo. estilo; C/Banda doble cara	2
TCK296	VOLKSWAGEN	GOLF	4 CIL, 2.0 L	1999-2003		2
TCK296	VOLKSWAGEN	JETTA	4 CIL, 2.0 L	1999-2008		2
TCK739M	VOLKSWAGEN	EUROVAN	5 CIL, 2.5 L	2002-2000		2
TCK333M	VOLKSWAGEN	BORA	4 CIL, 1.9 L DIESEL	2007-2007		3



**Master Automotriz 2010**  
**Productos Gates \* FORMAS Y DIMENSIONES**

Kit	Marca	Vehiculo	Motor	Años	Observaciones	Componentes
TCK333M	VOLKSWAGEN	EUROVAN	4 CIL, 1.9 L	2008-2007		3
TCK333M	VOLKSWAGEN	EUROVAN	4 CIL, 1.9 L DIESEL	2008-2005		3
TCK333M	VOLKSWAGEN	EUROVAN	4 CIL, 1.9 L DIESEL	2006-2006		3
TCK333M	VOLKSWAGEN	JETTA	4 CIL, 1.9 L DIESEL	2007-2005		3
TCK333M	VOLKSWAGEN	BORA	4 CIL, 1.9 L DIESEL	2007-2007		3
TCK333M	VOLKSWAGEN	EUROVAN	4 CIL, 1.9 L	2008-2007		3
TCK333M	VOLKSWAGEN	EUROVAN	4 CIL, 1.9 L DIESEL	2007-2006		3
TCK333M	VOLKSWAGEN	EUROVAN	4 CIL, 1.9 L DIESEL	2008-2008		3
TCK333M	VOLKSWAGEN	EUROVAN	4 CIL, 1.9 L DIESEL	2005-2005		3
TCK333M	VOLKSWAGEN	JETTA	4 CIL, 1.9 L DIESEL	2005-2005		3
TCK333M	VOLKSWAGEN	JETTA	4 CIL, 1.9 L DIESEL	2007-2006		3
TCK321	VOLKSWAGEN	JETTA	4 CIL, 1.9 L DIESEL	2001-2003		5

**Master Automotriz 2010**  
**Productos Gates \* FORMAS Y DIMENSIONES**

## Aplicaciones de bandas para motonetas – PowerLink®



**Bandas para**



MARCA	NO. EQUIPO ORIGINAL	MODELO SCOOTER	ANCHO (mm)	LONG NOMIN (mm)	ANGULO (°)	BANDA GATES
HONDA	SRCV-15.5-642	Aero 50, Tact 50	15.5	642	28°	Powerlink 642 15.5 28
	16.8 666	Tag 50	17	666	28°	Powerlink 666 17 28
	SRCV-16.5-684	Elite 80 cc	16.5	684	28°	Powerlink 684 16.5 28
	23100-GCC-7710-M1	Beat, Activa	18.5	730	28°	Powerlink 730 18.5 28
	23100-KEB8-9000	D1050	17.5	771	28°	Powerlink 771 17.5 28
	N/D	Aero 100	16.7	819	28°	Powerlink 819 16.7 28
	N/D	Dío 100	14.5	795	28°	Powerlink 795 14.5 28
VENTO	N/D	Elite 150	20	821	30°	Powerlink 821 20 30
	743 20 30	Van 125	20	743	30°	Powerlink 743 20 30
	5FA-17641-00	Triton	17.5	771	28°	Powerlink 771 17.5 28
	VS Belt 788 17 28	Zip	17	788	28°	Powerlink 788 17 28
YAMAHA	842 20 30	Phantom R4i	20	842	30°	Powerlink 842 20 30
	5FA-17641-00	Bws100, W100S, Jog 100	17.5	771	28°	Powerlink 771 17.5 28
	782 14.5 28	Jog 50	14.5	782	28°	Powerlink 782 14.5 28
	16.6 x 797	Runner	17	788	28°	Powerlink 788 17 28
SUSUKI	N/D	MINT 50	14.5	795	28°	Powerlink 795 14.5 28
	27601-25E00	Akira 50 cc	17	666	28°	Powerlink 666 17 28
	17 675	AE 50	17	666	28°	Powerlink 666 17 28
DINAMO	743 20 30	Sukira 125	20	743	30°	Powerlink 743 20 30
	743 20 30	Adventure 125 cc	20	743	30°	Powerlink 743 20 30
	QJIANG 821 20 30	TT 150 cc	20	842	30°	Powerlink 842 20 30
KAWASAKI	27601-25E00	Adventure 150	20	842	30°	Powerlink 842 20 30
	KMYCO 23100-KEB8-9000	Axis 100	17.5	771	28°	Powerlink 771 17.5 28
KAMAJI	253 N5 1304	Kami	18.1	669	28°	Powerlink 669 18.1 28
	Powerlink VE 743 20	Kripton	20	743	30°	Powerlink 743 20 30
	VS Belt 842 20 30	Jerry, Everest	20	842	30°	Powerlink 842 20 30
CARABELA	743 20 30	Delta 125, Islo 125, SL 125, Gorilla 150	20	743	30°	Powerlink 743 20 30
	669 18.1 28	Laser 90	18.1	669	28°	Powerlink 669 18.1 28
	788 17 28	Islo 50, Runner 90	17	788	28°	Powerlink 788 17 28
	N/D	Power 150	20	835	30°	Powerlink 835 20 30
	N/D	VX 150, Road Power 150	17	795	28°	Powerlink 795 17 28
ITALIKA	N/D	Diabolo 150GT	20	835	30°	Powerlink 835 20 30
	N/D	Vendetta 90	18.1	669	28°	Powerlink 669 18.1 28
	N/D	City EX125T, Diabolo EX125	20	743	30°	Powerlink 743 20 30
TORO	N/D	Miura	20	835	30°	Powerlink 835 20 30
	N/D	Festival Bravo	20	743	30°	Powerlink 743 20 30
WINDSOR	N/D	Motbn 11	15.5	650	28°	Powerlink 650 15.5 28
	N/D	Motbn 15	15	655	28°	Powerlink 655 15 28
	N/D	Motbn 18	14.5	795	28°	Powerlink 795 14.5 28
	N/D	Motbn 17	17	795	28°	Powerlink 795 17 28
	N/D	Motbn 12	16.7	819	28°	Powerlink 819 16.7 28
	N/D	Motbn 19	18.5	730	28°	Powerlink 730 18.5 28
	N/D	Motbn 21	20	743	30°	Powerlink 743 20 30
	N/D	Motbn 14	17.5	771	28°	Powerlink 771 17.5 28
N/D	Motbn 16	17	788	28°	Powerlink 788 17 28	





**Master Automotriz 2010**  
**Productos Gates \* FORMAS Y DIMENSIONES**



## Aplicaciones de bandas para Cuatrimotos – PowerLink®



Serie PL20 = Estándar , PL30 = Premium

No. Parte	Ancho x Largo	Angulo
PL20110	19/32" x 25 1/4"	30
PL20205	21/32" x 30 3/4"	30
PL20206	5/8" x 30 3/4"	30
PL20207	21/32" x 30 7/8"	28
PL20302	21/32" x 29 3/4"	28
PL20303	21/32" x 31 3/8"	28
PL20304	21/32" x 32 7/8"	28
PL20501	23/32" x 31 3/4"	28
PL20504	23/32" x 29 1/2"	28
PL20507	23/32" x 26 3/8"	30
PL20509	11/16" x 30 7/8"	30
PL20601	23/32" x 28 7/8"	28
PL20602	23/32" x 30 3/4"	28
PL20705	25/32" x 32 7/8"	30
PL20707	25/32" x 29 1/4"	30
PL20708	25/32" x 33 1/8"	30
PL20709	25/32" x 33 1/4"	30
PL30068	1 1/16" x 42 1/4"	30
PL30069	1 1/8" x 33 3/8"	28
PL30070	1 3/16" x 33 5/8"	28
PL30071	1 3/16" x 40 7/8"	24
PL30072	1 3/16" x 40 7/8"	24
PL30073	1 3/16" x 33 1/4"	28
PL30074	1 3/16" x 43 7/8"	28

No. Parte	Ancho x Largo	Angulo
PL30075	1 3/16" x 41 1/4"	28
PL30076	1 3/16" x 42 1/4"	28
PL30077	1 3/16" x 43 3/8"	26
PL30078	1 3/16" x 43 3/4"	28
PL30079	1 3/16" x 34 3/8"	28
PL30080	1 1/4" x 37 1/8"	25
PL30081	1 1/4" x 39 1/4"	26
PL30082	1 1/4" x 41 5/8"	26
PL30083	1 1/4" x 57 1/4"	26
PL30084	1 9/32" x 37 1/4"	26
PL30085	1 5/16" x 37"	28
PL30086	1 1/4" x 37"	28
PL30087	1 5/16" x 38 5/8"	26
PL30088	1 9/32" x 40 1/2"	30
PL30089	1 7/16" x 36 7/8"	28
PL30090	1 13/32" x 52 1/8"	28
PL30091	1 7/16" x 36 3/4"	28
PL30110	19/32" x 25 1/4"	30
PL30205	21/32" x 30 3/4"	30
PL30206	5/8" x 30 3/4"	30
PL30207	21/32" x 30 7/8"	28
PL30302	21/32" x 29 3/4"	28
PL30303	21/32" x 31 3/8"	28
PL30304	21/32" x 32 7/8"	28

No. Parte	Ancho x Largo	Angulo
PL30360	11/16" x 35 1/4"	28
PL30361	11/16" x 26 5/8"	30
PL30362	11/16" x 28 3/8"	28
PL30363	23/32" x 35 1/4"	30
PL30501	23/32" x 31 3/4"	28
PL30504	23/32" x 29 1/2"	28
PL30507	23/32" x 26 3/8"	30
PL30509	11/16" x 30 7/8"	30
PL30564	23/32" x 26 7/8"	28
PL30565	23/32" x 29 7/8"	28
PL30601	23/32" x 28 7/8"	28
PL30701	23/32" x 32 1/4"	28
PL30705	25/32" x 32 7/8"	30
PL30707	25/32" x 29 1/4"	30
PL30708	25/32" x 33 1/8"	30
PL30709	25/32" x 33 1/4"	30
PL30766	25/32" x 36 7/8"	30
PL30801	29/32" x 32 3/4"	28
PL30807	27/32" x 29 7/8"	30
PL30808	7/8" x 35 5/8"	30
PL30904	29/32" x 35 1/4"	28
PL30967	31/32" x 41 3/8"	28

No. Parte	Aplicación
PL20302	Aprilia Motoneta 2004-2003 Rally 50 49cc
PL30302	Aprilia Motoneta 2004-2003 Rally 50 49cc
PL30701	Aprilia Motoneta 2003-1999 Scarabeo 125 124cc
PL30701	Aprilia Motoneta 2004-2000 Scarabeo 150 149cc
PL30701	Aprilia Motoneta 2006-2005 Scarabeo 150 151cc
PL20302	Aprilia Motoneta 2006-1993 Scarabeo 50 49cc
PL30302	Aprilia Motoneta 2006-1993 Scarabeo 50 49cc
PL20602	Aprilia Motoneta 2006-2001 Scarabeo 50 DiTech 49cc
PL20302	Aprilia Motoneta 2001-1997 SR50 49cc
PL30302	Aprilia Motoneta 2001-1997 SR50 49cc
PL30073	Arctic Cat, Inc. Cuatrimoto 2002-2002 375 Automatic 376cc
PL30073	Arctic Cat, Inc. Cuatrimoto 2002-2002 400 371cc
PL30073	Arctic Cat, Inc. Cuatrimoto 2007-2003 400 376cc
PL30073	Arctic Cat, Inc. Cuatrimoto 2004-2003 400 ACT 376cc
PL30073	Arctic Cat, Inc. Cuatrimoto 2007-2003 400 Automatic 376cc
PL30073	Arctic Cat, Inc. Cuatrimoto 2004-2003 400 Automatic ACT 376cc
PL30073	Arctic Cat, Inc. Cuatrimoto 2004-2004 400 Automatic ACT MRP 376cc
PL30073	Arctic Cat, Inc. Cuatrimoto 2007-2005 400 Automatic LE 376cc
PL30073	Arctic Cat, Inc. Cuatrimoto 2004-2003 400 Automatic MRP 376cc
PL30073	Arctic Cat, Inc. Cuatrimoto 2006-2004 400 Automatic TBX 376cc
PL30073	Arctic Cat, Inc. Cuatrimoto 2007-2006 400 Automatic TRV 376cc
PL30073	Arctic Cat, Inc. Cuatrimoto 2006-2005 400 Automatic VP 376cc

No. Parte	Aplicación
PL30073	Arctic Cat, Inc. Cuatrimoto 2005-2004 400 DVX 398cc
PL30073	Arctic Cat, Inc. Cuatrimoto 2006-2005 400 VP 376cc
PL30360	Arctic Cat, Inc. Cuatrimoto 2005-2004 50 49cc
PL30361	Arctic Cat, Inc. Cuatrimoto 2006-2006 50 49cc
PL30089	Arctic Cat, Inc. Cuatrimoto 2007-2000 500 493cc
PL30089	Arctic Cat, Inc. Cuatrimoto 2007-2000 500 Automatic 493cc
PL30089	Arctic Cat, Inc. Cuatrimoto 2006-2005 500 Automatic LE 493cc
PL30089	Arctic Cat, Inc. Cuatrimoto 2004-2003 500 Automatic MRP 493cc
PL30089	Arctic Cat, Inc. Cuatrimoto 2006-2002 500 Automatic TBX 493cc
PL30089	Arctic Cat, Inc. Cuatrimoto 2006-2004 500 Automatic TRV 493cc
PL30089	Arctic Cat, Inc. Cuatrimoto 2003-2002 500i Automatic 493cc
PL30091	Arctic Cat, Inc. Cuatrimoto 2007-2005 650 H1 Automatic 641cc
PL30091	Arctic Cat, Inc. Cuatrimoto 2007-2007 650 H1 Automatic LE 641cc
PL30091	Arctic Cat, Inc. Cuatrimoto 2007-2007 650 H1 Automatic TBX 641cc
PL30091	Arctic Cat, Inc. Cuatrimoto 2007-2007 650 H1 Automatic TRV 641cc
PL30091	Arctic Cat, Inc. Cuatrimoto 2007-2007 650 H1 Prowler 641cc
PL30091	Arctic Cat, Inc. Cuatrimoto 2007-2006 650 H1 Prowler XT 641cc
PL30091	Arctic Cat, Inc. Cuatrimoto 2006-2006 650 H1 SE 641cc
PL30091	Arctic Cat, Inc. Cuatrimoto 2007-2007 650 H1 TRV LE 641cc
PL30089	Arctic Cat, Inc. Cuatrimoto 2007-2007 700 EFI Automatic 695cc
PL30089	Arctic Cat, Inc. Cuatrimoto 2007-2007 700 EFI Automatic LE 695cc
PL30564	Arctic Cat, Inc. Cuatrimoto 2005-2004 90 81cc



## Master Automotriz 2010 Productos Gates \* FORMAS Y DIMENSIONES

### Aplicaciones para bandas PowerLink® - (CONTINUA)

No. Parte	Aplicación
PL30360	Arctic Cat, Inc. Cuatrimoto 2004-2002 90 89cc
PL30362	Arctic Cat, Inc. Cuatrimoto 2007-2006 90 90cc
PL30362	Arctic Cat, Inc. Cuatrimoto 2007-2007 DVX 90 90cc
PL30076	Argo Vehículo Utilitario 2007-2005 Avenger 8x8 674cc
PL30076	Argo Vehículo Utilitario 2007-2007 Avenger EFI 8x8 748cc
PL30090	Argo Vehículo Utilitario 2006-2004 Bigfoot 6x6 570cc
PL30090	Argo Vehículo Utilitario 2006-2004 Conquest 6x6 617cc
PL30090	Argo Vehículo Utilitario 2006-2006 Conquest 8x8 617cc
PL30090	Argo Vehículo Utilitario 2005-2004 Conquest 8x8 620cc
PL30090	Argo Vehículo Utilitario 2007-2004 Response 8x8 570cc
PL30090	Argo Vehículo Utilitario 2007-2004 Vanguard 2 6x6 480cc
PL30090	Argo Vehículo Utilitario 2007-2004 Vanguard 6x6 480cc
PL20705	Blade Powersports, Inc. Go Karts 2006-2005 150DX 150cc
PL30705	Blade Powersports, Inc. Go Karts 2006-2005 150DX 150cc
PL30363	Bombardier Cuatrimoto 2006-2004 DS50 49cc
PL30363	Bombardier Cuatrimoto 2003-2003 DS50 50cc
PL30363	Bombardier Cuatrimoto 2006-2005 DS90 83cc
PL30080	Bombardier Cuatrimoto 2005-2004 Outlander 330 HO 325cc
PL30080	Bombardier Cuatrimoto 2003-2003 Outlander 400 400cc
PL30080	Bombardier Cuatrimoto 2006-2004 Outlander 400 HO 400cc
PL30087	Bombardier Cuatrimoto 2006-2006 Outlander 800 HO EFI 800cc
PL30080	Bombardier Cuatrimoto 2006-2004 Outlander MAX 400 HO 400cc
PL30084	Bombardier Cuatrimoto 2003-2003 Quest 500 498cc
PL30084	Bombardier Cuatrimoto 2003-2003 Quest 650 644cc
PL30084	Bombardier Cuatrimoto 2004-2004 Traxter 498cc
PL30084	Bombardier Cuatrimoto 2005-2005 Traxter 500 498cc
PL30084	Bombardier Cuatrimoto 2005-2005 Traxter 500 Auto CVT 498cc
PL30084	Bombardier Cuatrimoto 2005-2005 Traxter 650 Auto CVT 644cc
PL30084	Bombardier Cuatrimoto 2004-2003 Traxter MAX 498cc
PL30084	Bombardier Cuatrimoto 2005-2005 Traxter MAX 500 498cc
PL30084	Bombardier Cuatrimoto 2005-2005 Traxter MAX 650 Auto CVT 644cc
PL30084	Bombardier Cuatrimoto 2004-2003 Traxter XL 498cc
PL30084	Bombardier Cuatrimoto 2005-2005 Traxter XL 500 498cc
PL30084	Bombardier Cuatrimoto 2003-2003 Traxter XT 498cc
PL30077	Bombardier Vehículo Utilitario 2005-2004 Sarasota 1000 249cc
PL30080	Can-Am Cuatrimoto 2007-2007 Outlander 400 HO 400cc
PL30087	Can-Am Cuatrimoto 2007-2007 Outlander 500 HO EFI 500cc
PL30087	Can-Am Cuatrimoto 2007-2007 Outlander 650 HO EFI 650cc
PL30087	Can-Am Cuatrimoto 2007-2007 Outlander 800 HO EFI 800cc
PL30080	Can-Am Cuatrimoto 2007-2007 Outlander Max 400 HO 400cc
PL30087	Can-Am Cuatrimoto 2007-2007 Outlander Max 500 HO EFI 500cc
PL30087	Can-Am Cuatrimoto 2007-2007 Outlander Max 650 HO EFI 650cc
PL30087	Can-Am Cuatrimoto 2007-2007 Outlander Max 800 HO EFI 800cc
PL30087	Can-Am Cuatrimoto 2007-2007 Outlander Max 800 HO EFI LTD 800cc
PL30087	Can-Am Cuatrimoto 2007-2007 Renegade 800 HO EFI 800cc
PL20304	Derbi Motoneta 2006-2001 Atlantis 50 49cc
PL30304	Derbi Motoneta 2006-2001 Atlantis 50 49cc
PL20205	ETON America Motoneta 2006-2005 Beamer II 49cc
PL30205	ETON America Motoneta 2006-2005 Beamer II 49cc
PL20205	ETON America Motoneta 2006-2005 Beamer Matrix 49cc
PL30205	ETON America Motoneta 2006-2005 Beamer Matrix 49cc
PL30074	Honda Cuatrimoto 1987-1985 Odyssey FL350 342cc
PL30967	Honda Go Karts 1984-1877 Odyssey FL250 248cc

No. Parte	Aplicación
PL20110	Honda Motoneta 2001-1990 Elite SA50 49cc
PL30110	Honda Motoneta 2001-1990 Elite SA50 49cc
PL30808	Honda Motoneta 2003-2001 Reflex 249cc
PL20509	Honda Motoneta 2008-2004 Ruckus 49cc
PL30509	Honda Motoneta 2008-2004 Ruckus 49cc
PL20302	ItalJet Motoneta 2004-1998 Dragster 50 50cc
PL30302	ItalJet Motoneta 2004-1998 Dragster 50 50cc
PL20302	ItalJet Motoneta 2003-2003 Scoop 50 50cc
PL30302	ItalJet Motoneta 2003-2003 Scoop 50 50cc
PL30083	John Deere Vehículo Utilitario 2005-1993 Gator 617cc
PL30083	John Deere Vehículo Utilitario 2004-2004 Gator 658cc Diesel
PL30083	John Deere Vehículo Utilitario 2005-1999 Trail Gator 617cc
PL30083	John Deere Vehículo Utilitario 2006-2004 Trail Gator 658cc Diesel
PL30083	John Deere Vehículo Utilitario 2004-2004 Worksite Gator 617cc
PL30069	Kawasaki Cuatrimoto 2007-2005 Brute Force 650 4x4 633cc
PL30069	Kawasaki Cuatrimoto 2007-2007 Brute Force 650 4x4i 633cc
PL30069	Kawasaki Cuatrimoto 2007-2005 Brute Force 750 4x4i 749cc
PL30069	Kawasaki Cuatrimoto 2007-2004 KFX700 697cc
PL30069	Kawasaki Cuatrimoto 2006-2004 KFX700 IG 697cc
PL30565	Kawasaki Cuatrimoto 2006-2003 KFX80 82cc
PL30081	Kawasaki Cuatrimoto 2002-1999 Prairie 300 290cc
PL30069	Kawasaki Cuatrimoto 2006-2004 Prairie 360 362cc
PL30068	Kawasaki Cuatrimoto 1998-1998 Prairie 400 391cc
PL30088	Kawasaki Cuatrimoto 2002-1999 Prairie 400 391cc
PL30068	Kawasaki Cuatrimoto 1997-1997 Prairie 400 4x4 391cc
PL30069	Kawasaki Cuatrimoto 2003-2003 Prairie 650 4x4 633cc
PL30069	Kawasaki Cuatrimoto 2002-2002 Prairie 650 633cc
PL30069	Kawasaki Cuatrimoto 2006-2004 Prairie 700 4x4 697cc
PL30078	Kawasaki Vehículo Utilitario 1997-1997 Mule 2500 617cc
PL30078	Kawasaki Vehículo Utilitario 1997-1997 Mule 2510 4x4 617cc
PL30082	Kawasaki Vehículo Utilitario 2003-2000 Mule 2510 Diesel 953cc Diesel
PL30078	Kawasaki Vehículo Utilitario 1997-1997 Mule 2520 Turf 617cc
PL30082	Kawasaki Vehículo Utilitario 2004-2001 Mule 3000 617cc
PL30082	Kawasaki Vehículo Utilitario 2007-2001 Mule 3010 4x4 617cc
PL30082	Kawasaki Vehículo Utilitario 2004-2004 Mule 3010 Diesel 953cc Diesel
PL30082	Kawasaki Vehículo Utilitario 2003-2001 Mule 3020 617cc
PL20705	Kinroad Go Karts 2005-2005 Boxer 150 150cc
PL30705	Kinroad Go Karts 2005-2005 Boxer 150 150cc
PL20705	Kinroad Go Karts 2006-2005 Sahara 150 150cc
PL30705	Kinroad Go Karts 2006-2005 Sahara 150 150cc
PL30904	Kymco Motoneta 2006-2005 Bet & Win 250 249cc
PL30904	Kymco Motoneta 2004-2002 Bet & Win 250 251cc
PL20504	Kymco Motoneta 2003-2000 Cobra 50 50cc
PL30504	Kymco Motoneta 2003-2000 Cobra 50 50cc
PL20504	Kymco Motoneta 2004-2001 Cobra Cross 50cc
PL30504	Kymco Motoneta 2004-2001 Cobra Cross 50cc
PL30904	Kymco Motoneta 2006-2005 Grandvista 250 249cc
PL30904	Kymco Motoneta 2004-2004 Grandvista 250 251cc
PL20504	Kymco Motoneta 2006-2000 People 50 49cc
PL30504	Kymco Motoneta 2006-2000 People 50 49cc
PL20504	Kymco Motoneta 2006-2002 Super 9 49cc
PL30504	Kymco Motoneta 2006-2002 Super 9 49cc
PL20504	Kymco Motoneta 2006-2004 Vitality 50 49cc



## Master Automotriz 2010 Productos Gates \* FORMAS Y DIMENSIONES

### Aplicaciones para bandas PowerLink® - (CONTINUA)

No. Parte	Aplicación
PL30504	Kymco Motoneta 2006-2004 Vitality 50 49cc
PL20504	Kymco Motoneta 2003-2002 Yup 50 50cc
PL30504	Kymco Motoneta 2003-2002 Yup 50 50cc
PL20601	Kymco Motoneta 2006-2000 ZX 50 49cc
PL30601	Kymco Motoneta 2006-2000 ZX 50 49cc
PL20302	Malaguti Motoneta 2005-2002 Ciak 50 49cc
PL30302	Malaguti Motoneta 2005-2002 Ciak 50 49cc
PL20302	Malaguti Motoneta 2005-2002 F12 Phantom 49cc
PL30302	Malaguti Motoneta 2005-2002 F12 Phantom 49cc
PL20302	Malaguti Motoneta 2005-2002 F15 Firefox 49cc
PL30302	Malaguti Motoneta 2005-2002 F15 Firefox 49cc
PL20303	Malaguti Motoneta 2006-2001 Yesterday 49cc
PL30303	Malaguti Motoneta 2006-2001 Yesterday 49cc
PL20501	Piaggio Motoneta 2006-2004 Typhoon 50 49cc
PL30501	Piaggio Motoneta 2006-2004 Typhoon 50 49cc
PL30801	Piaggio Motoneta 2003-2003 X9 Evolution 200 198cc
PL30801	Piaggio Motoneta 2006-2004 X9 Evolution 500 460cc
PL30071	Polaris Cuatrimoto 1995-1994 300 283cc
PL30071	Polaris Cuatrimoto 1995-1994 400L 378cc
PL30071	Polaris Cuatrimoto 2005-2004 ATP 330 329cc
PL30072	Polaris Cuatrimoto 2005-2004 ATP 500 HO 499cc
PL30071	Polaris Cuatrimoto 1993-1993 Big Boss 250 6x6 244cc
PL30071	Polaris Cuatrimoto 1994-1994 Big Boss 300 6x6 283cc
PL30071	Polaris Cuatrimoto 1993-1993 Big Boss 350L 6x6 352cc
PL30071	Polaris Cuatrimoto 1997-1994 Big Boss 400L 6x6 378cc
PL30071	Polaris Cuatrimoto 1992-1989 Big Boss 4x6 244cc
PL30071	Polaris Cuatrimoto 1999-1998 Big Boss 500 6x6 499cc
PL30072	Polaris Cuatrimoto 1999-1998 Big Boss 500 6x6 499cc
PL30071	Polaris Cuatrimoto 1992-1991 Big Boss 6x6 244cc
PL30071	Polaris Cuatrimoto 1987-1987 Cyclone 244cc
PL30072	Polaris Cuatrimoto 2001-1999 Diesel 455cc Diesel
PL30071	Polaris Cuatrimoto 2002-2000 Magnum 325 2x4 325cc
PL30072	Polaris Cuatrimoto 2000-2000 Magnum 325 2x4 325cc
PL30071	Polaris Cuatrimoto 2002-2000 Magnum 325 4x4 325cc
PL30072	Polaris Cuatrimoto 2002-2000 Magnum 325 4x4 325cc
PL30071	Polaris Cuatrimoto 2006-2003 Magnum 330 329cc
PL30072	Polaris Cuatrimoto 2004-2003 Magnum 330 329cc
PL30071	Polaris Cuatrimoto 1998-1995 Magnum 425 425cc
PL30072	Polaris Cuatrimoto 1998-1998 Magnum 425 425cc
PL30071	Polaris Cuatrimoto 2000-2000 Magnum 500 499cc
PL30072	Polaris Cuatrimoto 2002-1999 Magnum 500 499cc
PL30072	Polaris Cuatrimoto 2003-2003 Magnum 500 4x4 HDS 499cc
PL30071	Polaris Cuatrimoto 1997-1996 Magnum 6x6 425cc
PL30363	Polaris Cuatrimoto 2006-2006 Predator 90 89cc
PL30071	Polaris Cuatrimoto 1986-1985 Scrambler 244cc
PL30071	Polaris Cuatrimoto 1996-1995 Scrambler 378cc
PL30071	Polaris Cuatrimoto 2002-2000 Scrambler 400 2x4 378cc
PL30071	Polaris Cuatrimoto 1999-1998 Scrambler 400 378cc
PL30071	Polaris Cuatrimoto 2002-2000 Scrambler 400 4x4 378cc
PL30071	Polaris Cuatrimoto 1997-1997 Scrambler 400L 378cc
PL30071	Polaris Cuatrimoto 2002-2002 Scrambler 500 2x4 499cc
PL30071	Polaris Cuatrimoto 2000-2000 Scrambler 500 498cc
PL30071	Polaris Cuatrimoto 2007-1997 Scrambler 500 499cc

No. Parte	Aplicación
PL30071	Polaris Cuatrimoto 2002-2002 Scrambler 500 4x4 499cc
PL30071	Polaris Cuatrimoto 2001-1998 Sport 400 378cc
PL30071	Polaris Cuatrimoto 1997-1994 Sport 400L 378cc
PL30071	Polaris Cuatrimoto 2001-1998 Sportsman 335 334cc
PL30071	Polaris Cuatrimoto 1995-1994 Sportsman 378cc
PL30071	Polaris Cuatrimoto 2005-2002 Sportsman 400 425cc
PL30071	Polaris Cuatrimoto 1997-1996 Sportsman 400L 378cc
PL30071	Polaris Cuatrimoto 2007-2006 Sportsman 450 455cc
PL30071	Polaris Cuatrimoto 2001-1996 Sportsman 500 499cc
PL30072	Polaris Cuatrimoto 2001-1998 Sportsman 500 499cc
PL30071	Polaris Cuatrimoto 2007-2007 Sportsman 500 EFI 499cc
PL30072	Polaris Cuatrimoto 2006-2006 Sportsman 500 EFI 499cc
PL30071	Polaris Cuatrimoto 2006-2002 Sportsman 500 HO 499cc
PL30072	Polaris Cuatrimoto 2005-2002 Sportsman 500 HO 499cc
PL30072	Polaris Cuatrimoto 2005-2003 Sportsman 600 Twin 597cc
PL30071	Polaris Cuatrimoto 2007-2000 Sportsman 6x6 499cc
PL30072	Polaris Cuatrimoto 2006-2006 Sportsman 700 EFI 683cc
PL30072	Polaris Cuatrimoto 2005-2005 Sportsman 700 Military Vehicle 683cc
PL30072	Polaris Cuatrimoto 2006-2002 Sportsman 700 Twin 683cc
PL30072	Polaris Cuatrimoto 2005-2005 Sportsman 700 Twin EFI 683cc
PL30075	Polaris Cuatrimoto 2006-2006 Sportsman 800 EFI 760cc
PL30075	Polaris Cuatrimoto 2005-2005 Sportsman 800 Twin EFI 760cc
PL30363	Polaris Cuatrimoto 2006-2006 Sportsman 90 89cc
PL30072	Polaris Cuatrimoto 2006-2006 Sportsman MV7 683cc
PL30072	Polaris Cuatrimoto 2006-2006 Sportsman X2 500 499cc
PL30071	Polaris Cuatrimoto 2002-1990 Trail Blazer 244cc
PL30071	Polaris Cuatrimoto 2006-2003 Trail Blazer 250 244cc
PL30071	Polaris Cuatrimoto 2003-2003 Trail Blazer 400 378cc
PL30071	Polaris Cuatrimoto 1997-1996 Trail Blazer ES 244cc
PL30071	Polaris Cuatrimoto 1987-1985 Trail Boss 244cc
PL30071	Polaris Cuatrimoto 1999-1988 Trail Boss 250 244cc
PL30071	Polaris Cuatrimoto 2000-2000 Trail Boss 325 325cc
PL30071	Polaris Cuatrimoto 2002-2001 Trail Boss 325cc
PL30071	Polaris Cuatrimoto 2007-2003 Trail Boss 330 329cc
PL30071	Polaris Cuatrimoto 1991-1990 Trail Boss 350L 350cc
PL30071	Polaris Cuatrimoto 1993-1992 Trail Boss 350L 352cc
PL30071	Polaris Cuatrimoto 2002-2000 Xplorer 250 244cc
PL30071	Polaris Cuatrimoto 1999-1996 Xplorer 300 283cc
PL30071	Polaris Cuatrimoto 2002-1998 Xplorer 400 378cc
PL30071	Polaris Cuatrimoto 1997-1995 Xplorer 400L 378cc
PL30071	Polaris Cuatrimoto 1997-1997 Xplorer 500 499cc
PL30071	Polaris Cuatrimoto 1999-1996 Xpress 300 283cc
PL30071	Polaris Cuatrimoto 1997-1996 Xpress 400 378cc
PL30071	Polaris Vehículo Utilitario 2004-2000 Ranger 425cc
PL30071	Polaris Vehículo Utilitario 2007-1998 Ranger 499cc
PL30075	Polaris Vehículo Utilitario 2007-2006 Ranger 683cc
PL30071	Polaris Vehículo Utilitario 2008-2008 Ranger RZR 760cc
PL30075	Polaris Vehículo Utilitario 2007-2006 Ranger XP 683cc
PL30071	Polaris Vehículo Utilitario 1999-1999 Worker 335 334cc
PL30071	Polaris Vehículo Utilitario 2001-1999 Worker 500 499cc
PL30072	Polaris Vehículo Utilitario 2001-2001 Worker 500 499cc
PL20707	Roketa Motoneta 2007-2007 Bahama 50 50cc
PL30707	Roketa Motoneta 2007-2007 Bahama 50 50cc



**Master Automotriz 2010**  
**Productos Gates \* FORMAS Y DIMENSIONES**  
**Aplicaciones para bandas PowerLink® - (CONTINUA)**

No. Parte	Aplicación
PL20707	Roketa Motoneta 2007-2007 Boca 50 50cc
PL30707	Roketa Motoneta 2007-2007 Boca 50 50cc
PL20707	Roketa Motoneta 2007-2007 Lambda 50 50cc
PL30707	Roketa Motoneta 2007-2007 Lambda 50 50cc
PL20707	Roketa Motoneta 2007-2007 Maui 50GL 50cc
PL30707	Roketa Motoneta 2007-2007 Maui 50GL 50cc
PL20707	Roketa Motoneta 2007-2007 Maui 50ST 50cc
PL30707	Roketa Motoneta 2007-2007 Maui 50ST 50cc
PL20707	Roketa Motoneta 2007-2007 Sicily 50 50cc
PL30707	Roketa Motoneta 2007-2007 Sicily 50 50cc
PL30073	Suzuki Cuatrimoto 2007-2002 Eiger Auto 400 376cc
PL30565	Suzuki Cuatrimoto 1992-1989 QuadRunner 82cc
PL30565	Suzuki Cuatrimoto 2006-1993 QuadSport 80 82cc
PL30069	Suzuki Cuatrimoto 2005-2004 Twin Peaks 700 697cc
PL30089	Suzuki Cuatrimoto 2002-2002 Vinson 500 493cc
PL30089	Suzuki Cuatrimoto 2007-2003 Vinson Auto 500 493cc
PL30078	Suzuki Vehículo Utilitario 2005-2005 QUV 617cc
PL20504	SYM Motoneta 2005-2004 Jet 49cc
PL30504	SYM Motoneta 2005-2004 Jet 49cc
PL20709	TGB Motoneta 2007-2004 Delivery 150 151cc
PL30709	TGB Motoneta 2007-2004 Delivery 150 151cc
PL20709	TGB Motoneta 2005-2004 Laser 303R 150 151cc
PL30709	TGB Motoneta 2005-2004 Laser 303R 150 151cc
PL20709	TGB Motoneta 2007-2006 Laser R9 151cc
PL30709	TGB Motoneta 2007-2006 Laser R9 151cc
PL20709	TGB Motoneta 2007-2007 Sunset 150 151cc
PL30709	TGB Motoneta 2007-2007 Sunset 150 151cc
PL20507	TNG Motoneta 2007-2004 Milano 50 49cc
PL30507	TNG Motoneta 2007-2004 Milano 50 49cc
PL20705	Vento Motoneta 2006-2006 BKM Xeidon 150cc
PL30705	Vento Motoneta 2006-2006 BKM Xeidon 150cc
PL20705	Vento Motoneta 2005-2004 BKM Xenon 50cc

No. Parte	Aplicación
PL30705	Vento Motoneta 2005-2004 BKM Xenon 50cc
PL20705	Vento Motoneta 2006-2006 Phantera 150cc
PL30705	Vento Motoneta 2006-2006 Phantera 150cc
PL20705	Vento Motoneta 2006-2006 Phantom GT5 150cc
PL30705	Vento Motoneta 2006-2006 Phantom GT5 150cc
PL20708	Vento Motoneta 2003-2003 Phantom R3 150cc
PL30708	Vento Motoneta 2003-2003 Phantom R3 150cc
PL20705	Vento Motoneta 2006-2005 Phantom R4i 150cc
PL20708	Vento Motoneta 2006-2004 Phantom R4i 150cc
PL30705	Vento Motoneta 2006-2005 Phantom R4i 150cc
PL30708	Vento Motoneta 2006-2004 Phantom R4i 150cc
PL30766	Yamaha Cuatrimoto 2004-1991 Breeze 124cc
PL30070	Yamaha Cuatrimoto 2006-2004 Bruin 350 Automatic 348cc
PL30766	Yamaha Cuatrimoto 2007-2004 Grizzly 125 124cc
PL30086	Yamaha Cuatrimoto 1999-1998 Grizzly 595cc
PL30086	Yamaha Cuatrimoto 2001-2000 Grizzly 600 595cc
PL30085	Yamaha Cuatrimoto 2003-2002 Grizzly 660 660cc
PL30085	Yamaha Cuatrimoto 2007-2004 Grizzly 660 Automatic 660cc
PL30079	Yamaha Cuatrimoto 2003-2000 Kodiak 400 401cc
PL30079	Yamaha Cuatrimoto 2006-2004 Kodiak 400 Automatic 401cc
PL30079	Yamaha Cuatrimoto 2003-2003 Kodiak 450 449cc
PL30079	Yamaha Cuatrimoto 2006-2006 Kodiak 450 Automatic 421cc
PL30079	Yamaha Cuatrimoto 2005-2004 Kodiak 450 Automatic 449cc
PL30070	Yamaha Cuatrimoto 2007-2007 Wolverine 350 348cc
PL20206	Yamaha Motoneta 1993-1989 Jog 49cc
PL20207	Yamaha Motoneta 1998-1994 Jog 49cc
PL30206	Yamaha Motoneta 1993-1989 Jog 49cc
PL30207	Yamaha Motoneta 1998-1994 Jog 49cc
PL30807	Yamaha Motoneta 2000-1995 Riva 125 124cc
PL30079	Yamaha Vehículo Utilitario 2007-2006 Rhino 450 Automatic 421cc
PL30085	Yamaha Vehículo Utilitario 2007-2006 Rhino 660 Automatic 660cc





## Master Automotriz 2010

### Productos Gates \* FORMAS Y DIMENSIONES

#	VEHICULO	MARCA	AÑO	LONGITUD EN PULGADAS			E											
				PILOTO	COPILOTO	TRASERO	E											
147	ALFA ROMEO	04-08	21	16		38-160				21-160			2021	2016	16-210	16-160	MEGAVISION 21/16	
159	ALFA ROMEO	02-06	22	21		30-221				21-220			2022	2021	16-220	16-210	MEGAVISION 22/20	
200 SX	NISSAN	95-98	21	19					30-219	21-190			2021	2019	16-210	16-190	MEGAVISION 19/21	
206	PEUGEOT	99-08	24	19		30-240	38-160			21-240	21-160		2024	2016	16-240	16-160		
207	PEUGEOT	08-09	26	18		26-1	38-160			21-160			2016		16-260	16-160		
240 SX	NISSAN	89-94	20	20		38-200	38-200			21-200	21-200		2020	2020	16-200	16-200	MEGAVISION 20	
240 SX	NISSAN	95-98	21	19					30-219	21-190			2021	2019	16-210	16-190	MEGAVISION 19/21	
3	MAZDA	05-08	21	19					30-219	21-190			2021	2019	16-210	16-190	MEGAVISION 19/21	
300 GT	MITSUBISHI	91-98	21	20			38-200			21-200			2021	2020	16-210	16-220		
300 M	CHRYSLER	99-05	24	22		30-240	38-220			21-240	21-220		2024	2022	16-240	16-220	MEGAVISION 24/22	
300 ZX	NISSAN	91-98	21	21	16		38-160				21-160		2021	2021	2016	16-210	16-210	16-160
306	PEUGEOT	97-08	22	20		38-220	38-200			21-220	21-200		2022	2020	16-220	16-200	MEGAVISION 22/20	
307	PEUGEOT	03-06	24	22		30-240	38-220			21-240	21-220		2024	2022	16-240	16-220	MEGAVISION 24/22	
320i	BMW	98-07	22	20		38-220	38-200			21-220	21-200		2022	2020	16-220	16-200	MEGAVISION 22/20	
323	MAZDA	86-93	18	18		38-180	38-180			21-180	21-180		2018	2018	16-180	16-180	MEGAVISION 18	
323i	BMW	98-07	22	20		38-220	38-200			21-220	21-200		2022	2020	16-220	16-200	MEGAVISION 22/20	
325i	BMW	98-07	22	20		38-220	38-200			21-220	21-200		2022	2020	16-220	16-200	MEGAVISION 22/20	
328i	BMW	98-07	22	20		38-220	38-200			21-220	21-200		2022	2020	16-220	16-200	MEGAVISION 22/20	
330i	BMW	98-07	22	20		38-220	38-200			21-220	21-200		2022	2020	16-220	16-200		
350Z	NISSAN	02-04	20	18		38-200	38-180	38-160		21-220	21-180	21-160	2020	2016	2016	16-200	16-180	16-160
350Z	NISSAN	05-07	24	22		30-240	38-220			21-240	21-220		2024	2022	16-240	16-220	MEGAVISION 24/22	
4 RUNNER	TOYOTA	03-08	22	20		38-220	38-200			21-220	21-200		2022	2020	16-220	16-200	MEGAVISION 22/20	
405	PEUGEOT	97-02	22	22		30-221	30-221			21-220	21-220		2022	2022	16-220	16-220	MEGAVISION 22	
406	PEUGEOT	01-08	24	22		30-240	38-220			21-240	21-220		2024	2022	16-240	16-220	MEGAVISION 24/22	
407	PEUGEOT	06-08	28	28		28-9	28-9		SUV2828						16-280	16-280		
408	PEUGEOT	05-08	28	28		28-9	28-9		SUV2828						16-280	16-280		
5	MAZDA	05-08	20	18		26-1	38-160			21-160			2016		16-260	16-160		
545i	BMW	03-07	24	24		30-240	30-240		SUV2424	21-240	21-240		2024	2024	16-240	16-240	MEGAVISION 24	
6	MAZDA	05-08	22	18		38-220	38-180			21-220	21-180		2022	2018	16-220	16-180	MEGAVISION 22/18	
607	PEUGEOT	04-06	24	22		30-204	38-220			21-240	21-220		2024	2022	16-240	16-220	MEGAVISION 24/22	
626	MAZDA	85-92	18	18		38-180	38-180			21-180	21-180		2018	2018	16-180	16-180	MEGAVISION 18	
626 HATCHBACK	MAZDA	85-92	18	18	16	38-180	38-180	38-160		21-180	21-180		2018	2018	16-180	16-180	MEGAVISION 18	
645i	BMW	03-07	24	24		30-240	30-240		SUV2424	21-240	21-240		2024	2024	16-240	16-240	MEGAVISION 24	
740i	BMW	98-00	24	22		30-240	38-220			21-240	21-220		2024	2022	16-240	16-220	MEGAVISION 24/22	
745i	BMW	04-08	24	24		30-240	30-240		SUV2424	21-240	21-240		2024	2024	16-240	16-240	MEGAVISION 24	
911	PORSCHE	97-07	22	22		30-221	30-221			21-220	21-220		2022	2022	16-220	16-220	MEGAVISION 22	
911 TURBO	PORSCHE	03-07	22	22		30-221	30-221			21-220	21-220		2022	2022	16-220	16-220	MEGAVISION 22	
9-3	SAAB	00-07	22	22		30-221	30-221			21-220	21-220		2022	2022	16-220	16-220	MEGAVISION 22	
9-5	SAAB	00-07	22	22		30-221	30-221			21-220	21-220		2022	2022	16-220	16-220	MEGAVISION 22	
A-160	MB	00-05	24	24	13	30-240	30-240		SUV2424	21-240	21-240	21-130	2024	2024	2013	16-240	16-240	MEGAVISION 24
A-190	MB	00-05	24	24	13	30-240	30-240		SUV2424	21-240	21-240	21-130	2024	2024	2013	16-240	16-240	MEGAVISION 24
A3	AUDI	99-08	21	19	15			38-150	30-219	21-190	21-150		2021	2019	2015	16-210	16-190	MEGAVISION 19/21
A4	AUDI	97-07	21	19	15			38-150	30-219	21-190	21-150		2021	2019	2015	16-210	16-190	MEGAVISION 19/21
A6	AUDI	95-03	22	22		30-221	30-221			21-220	21-220		2022	2022	16-220	16-220	MEGAVISION 22	
A8	AUDI	97-02	22	22		30-221	30-221			21-220	21-220		2022	2022	16-220	16-220	MEGAVISION 22	
ACADIA	GMC	01-06	26	20		26-1	38200			21-200			2020		16-260	16-200		
ACCORD	HONDA	86-90	19	18		38-190	38-190			21-190	21-190		2018	2019	16-190	16-190	MEGAVISION 19	
ACCORD	HONDA	94-02	24	20		30-240	38-200			21-240	21-200		2024	2020	16-240	16-200	MEGAVISION 24/20	



# Master Automotriz 2010

## Productos Gates \* FORMAS Y DIMENSIONES

A		PILOTO			COPILOTO			TRASERO			E			E					
VEHICULO	MARCA	AÑO	LONGITUD EN MILIMETROS			E			E			E							
ACCORD	HONDA	03-07	24	18		30-240	38-190		21-240	21-190		2024	2019	16-240	16-190	MEGAVISION 24/18			
AERIO	SUZUKI	05-08	22	18		38-220	38-180		21-220	21-180		2022	2018	16-220	16-180	MEGAVISION 22/18			
AEROSTAR	FORD	86-95	22	22	18	30-221	30-221	38-180	21-220	21-220	21-160	2022	2022	2016	16-220	16-220	16-160	MEGAVISION 22	
ALHAMBRA	SEAT	01-07	28	28		28-9	28-9	SUV2828							16-280	16-280			
ALLROAD QUATTRO	AUDI	00-07	22	22		30-221	30-221		21-220	21-220		2022	2022		16-220	16-220		MEGAVISION 22	
ALMERA	NISSAN	02-03	21	16	15		38-160	38-150		21-160	21-150	2021	2016	2015	16-210	16-160	16-150	MEGAVISION 21/16	
ALMERA	NISSAN	04-05	21	18				30-219		21-190		2021	2019		16-210	16-190		MEGAVISION 19/21	
ALTIMA	NISSAN	83-01	21	20			38-200			21-200		2021	2020		16-210	16-220			
ALTIMA	NISSAN	02-07	26	17		26-1	38-160						2017		16-260	16-170			
AMIGO	ISUZU	91-97	18	18		38-180	38-180		21-180	21-180		2018	2018		16-180	16-180		MEGAVISION 18	
APRID	NISSAN	07-09	18	18		38-180	38-180		21-180	21-180		2018	2018		16-180	16-180		MEGAVISION 18	
ARMADA	NISSAN	04-08	24	22		30-240	38-220		21-240	21-220		2024	2022		16-240	16-220		MEGAVISION 24/22	
ASPEN	CHRYSLER	06-08	26	21		26-1							2021		16-260	16-210			
ASTRA	CHEVROLET	00-08	21	18				30-219		21-190		2021	2019		16-210	16-190		MEGAVISION 19/21	
ASTRO	CHEVROLET	85-95	18	18	15	38-180	38-180	38-150	21-180	21-180	21-150	2018	2018	2015	16-180	16-180		MEGAVISION 18	
ATLANTIC	VOLKSWAGEN	80-88	18	18		38-180	38-180		21-160	21-160		2016	2016		16-160	16-160		MEGAVISION 16	
ATOS	HYUNDAI	01-09	20	16	15	38-200	38-160	38-150	21-200	21-160	21-150	2020	2016	2015	16-200	16-160		MEGAVISION 20/16	
ATTITUDE	HYUNDAI	05-09	22	18		30-221	38-160		21-220	21-160		2022	2016		16-220	16-160		MEGAVISION 22/16	
AVALANCHE	CHEVROLET	02-07	22	22		30-221	30-221		21-220	21-220		2022	2022		16-220	16-220		MEGAVISION 22	
AVANZA	TOYOTA	07-09	16	20		38-160	38-200		21-160	21-200		2016	2020		16-160	16-200			
AVENGER	DOODGE	07-09	22	22		22-1	22-1		21-220	21-220		2022	2022		16-220	16-220		MEGAVISION 22	
AVEO	CHEVROLET	07-09	22	16		30-221	38-160		21-220	21-160		2022	2016		16-220	16-160		MEGAVISION 22/16	
AVIATOR	LINCOLN	03-06	22	22	16	30-221	30-221	38-160	21-220	21-220	21-160	2022	2022	2016	16-220	16-220	16-160	MEGAVISION 22	
AZTEC	PONTIAC	01-05	24	22		30-240	38-220		21-240	21-220		2024	2022		16-240	16-220		MEGAVISION 24/22	
B2200	MAZDA	87-97	18	18		38-180	38-180		21-180	21-180		2018	2018		16-180	16-180		MEGAVISION 18	
B2600	MAZDA	88-94	18	18		38-180	38-180		21-180	21-180		2018	2018		16-180	16-180		MEGAVISION 18	
B3000	MAZDA	93-98	18	18		38-180	38-180		21-180	21-180		2018	2018		16-180	16-180		MEGAVISION 18	
B4000	MAZDA	94-98	18	18		38-180	38-180		21-180	21-180		2018	2018		16-180	16-180		MEGAVISION 18	
BEETLE	VOLKSWAGEN	98-07	21	18				30-219		21-190		2021	2019		16-210	16-190		MEGAVISION 19/21	
BERETTA	CHEVROLET	87-94	19	19		38-190	38-190		21-190	21-190		2019	2019		16-190	16-190		MEGAVISION 19	
BLAZER	CHEVROLET	85-91	18	18		38-160	38-160		21-160	21-160		2016	2016		16-160	16-160		MEGAVISION 16	
BLAZER	CHEVROLET	92-94	18	18	15	38-180	38-180	38-150	21-180	21-180	21-150	2018	2018	2015	16-180	16-180		MEGAVISION 18	
BLAZER	CHEVROLET	95-05	20	20	15	38-200	38-200	38-150	21-200	21-200	21-150	2020	2020	2015	16-200	16-200		MEGAVISION 20	
BONNEVILLE	PONTIAC	84-86	18	18		38-180	38-180		21-180	21-180		2018	2018		16-180	16-180		MEGAVISION 18	
BONNEVILLE	PONTIAC	87-91	19	19		38-190	38-190		21-190	21-190		2019	2019		16-190	16-190		MEGAVISION 19	
BONNEVILLE	PONTIAC	92-99	22	22		30-221	30-221		21-220	21-220		2022	2022		16-220	16-220		MEGAVISION 22	
BOXTER	PORSCHE	97-06	22	22		30-221	30-221		21-220	21-220		2022	2022		16-220	16-220		MEGAVISION 22	
BRASILIA	VOLKSWAGEN	75-83	18	18		38-180	38-180		21-180	21-180		2018	2018		16-180	16-180		MEGAVISION 18	
BRAVADA	OLDSMOBILE	90-94	18	18		38-160	38-160		21-160	21-160		2016	2016		16-160	16-160		MEGAVISION 16	
BRONCO	FORD	87-94	18	18		38-180	38-180		21-180	21-180		2018	2018		16-180	16-180		MEGAVISION 18	
C-1500	CHEVROLET	85-94	16	16		38-180	38-160		21-180	21-180		2016	2016		16-180	16-180		MEGAVISION 16	
C-220	MB	94-97	24	24		30-240	30-240	SUV2424	21-240	21-240		2024	2024		16-240	16-240		MEGAVISION 24	
C-230	MB	87-07	24	24	15	30-240	30-240	38-150	SUV2424	21-240	21-240	21-150	2024	2024	2015	16-240	16-240		MEGAVISION 24
C-240	MB	00-02	24	22		30-240	38-220		21-240	21-220		2024	2022		16-240	16-220		MEGAVISION 24/22	
C-2500	CHEVROLET	85-94	18	18		38-180	38-180		21-180	21-180		2018	2018		16-180	16-180		MEGAVISION 18	
C-280	MB	94-98	24	24		30-240	30-240	SUV2424	21-240	21-240		2024	2024		16-240	16-240		MEGAVISION 24	
C-3500	CHEVROLET	85-94	18	18		38-180	38-180		21-180	21-180		2018	2018		16-180	16-180		MEGAVISION 18	
CABSTAR	NISSAN	07-09	16	18		38-180	38-180		21-180	21-180		2016	2018		16-180	16-180		MEGAVISION 18	





## Master Automotriz 2010

### Productos Gates \* FORMAS Y DIMENSIONES

VEHICULO	MARCA	AÑO	LONGITUD EN PULGADAS			E												
			PILOTO	COPILOTO	TRASERO	E												
CALIBER	DOODGE	05-08	24	18	12	30-240	38-180	38-120	21-240	21-180	2024	2018	16-240	16-180	MEGAVISION 24/18			
CAMARO	CHEVROLET	82-92	18	18		38-180	38-180		21-180	21-180	2018	2018	16-180	16-180	MEGAVISION 18			
CAMARO Z28	CHEVROLET	95-03	24	24		30-240	30-240	SUV2424	21-240	21-240	2024	2024	16-240	16-240	MEGAVISION 24			
CAMRY	TOYOTA	02-05	24	18		30-240	36-190		21-240	21-190	2024	2018	16-240	16-190	MEGAVISION 24/18			
CANYON	GMC	05-08	22	18		30-221	36-190		21-220	21-190	2022	2019	16-220	16-190	MEGAVISION 22/18			
CAPRICE	CHEVROLET	85-90	18	18		38-180	38-180		21-180	21-180	2018	2018	16-180	16-180	MEGAVISION 18			
CAPRICE	CHEVROLET	91-96	22	22		30-221	30-221		21-220	21-220	2022	2022	16-220	16-220	MEGAVISION 22			
CAPTIVA	CHEVROLET	07-09	24	16		30-240	36-160		21-240	21-160	2024	2016	16-240	16-160				
CARAVAN	DOODGE	96-06	28	28	16	28-9	28-9	38-160	SUV2828	21-160	2018		16-280	16-280	16-160			
CARIBE	VOLKSWAGEN	77-87	16	18		38-160	38-160		21-160	21-160	2018	2018	16-160	16-160	MEGAVISION 16			
CARRERA GT	PORSCHE	03-05	22	22		30-221	30-221		21-220	21-220	2022	2022	16-220	16-220	MEGAVISION 22			
CATERA	CADILLAC	87-02	24	18		30-240	36-190		21-240	21-190	2024	2018	16-240	16-190	MEGAVISION 24/18			
CAVALIER	CHEVROLET	83-89	18	18		38-180	36-160		21-180	21-160	2018	2018	16-180	16-160	MEGAVISION 18			
CAVALIER	CHEVROLET	90-94	18	18		38-180	38-180		21-180	21-180	2018	2018	16-180	16-180	MEGAVISION 18			
CAVALIER	CHEVROLET	95-05	22	16		30-221	36-160		21-220	21-160	2022	2016	16-220	16-160	MEGAVISION 22/16			
CELEBRITY	CHEVROLET	84-90	18	18	16	38-180	38-180	38-160	21-180	21-180	21-160	2018	2018	2016	16-180	16-180	16-160	MEGAVISION 18
CENTURY	CHEVROLET	86-96	18	18		38-180	38-160		21-180	21-180	2018	2018	16-180	16-180	MEGAVISION 18			
CHARADE	DAIHATSU	88-92	18	18		38-180	38-180		21-180	21-180	2018	2018	16-180	16-180	MEGAVISION 18			
CHARGER	DOODGE	05-08	22	22		30-221	30-221		21-220	21-220	2022	2022	16-220	16-220	MEGAVISION 22			
CHEROKEE	JEEP	91-01	18	18	13	38-180	36-180		21-180	21-180	21-130	2018	2018	2013	16-180	16-180	MEGAVISION 18	
CHEVY	CHEVROLET	94-04	18	16	15	38-180	38-180	38-150	21-180	21-180	21-150	2018	2018	2015	16-180	16-180	MEGAVISION 18	
CHEVY C2	CHEVROLET	05-09	18	18	15	38-180	38-180	38-150	21-180	21-180	21-150	2018	2018	2015	16-180	16-180	MEGAVISION 18	
CHEYENNE	CHEVROLET	86-91	18	18		38-180	36-160		21-180	21-160	2018	2018	16-180	16-160	MEGAVISION 18			
CIRRUS	CHRYSLER	96-06	22	22		22-1	22-1		21-220	21-220	2022	2022	16-220	16-220	MEGAVISION 22			
CITATION	CHEVROLET	82-86	18	18		38-180	36-180		21-180	21-180	2018	2018	16-180	16-180	MEGAVISION 18			
CIVIC	HONDA	88-92	20	18	16	38-200	38-180	38-160	21-220	21-180	21-160	2020	2018	2018	16-200	16-180	16-160	MEGAVISION 20/18
CIVIC	HONDA	97-00	20	18		38-200	38-180		21-220	21-180	2020	2018	16-200	16-180	MEGAVISION 20/18			
CIVIC	HONDA	01-08	21	18				30-219		21-190	2021	2019	16-210	16-190	MEGAVISION 19/21			
CLIO	RENAULT	02-09	21	19				30-219		21-190	2021	2019	16-210	16-190	MEGAVISION 19/21			
CLK 320	MB	98-07	24	24		30-240	30-240	SUV2424	21-240	21-240	2024	2024	16-240	16-240	MEGAVISION 24			
CLK 430	MB	89-07	24	24		30-240	30-240	SUV2424	21-240	21-240	2024	2024	16-240	16-240	MEGAVISION 24			
CLUB WAGON	FORD	95-00	22	22		30-221	30-221		21-220	21-220	2022	2022	16-220	16-220	MEGAVISION 22			
COLORADO	CHEVROLET	04-08	22	18		30-221	38-190		21-220	21-190	2022	2019	16-220	16-190	MEGAVISION 22/18			
COLT	DOODGE	85-90	20	16		38-200	38-180		21-220	21-180	2020	2018	16-200	16-180	MEGAVISION 20/18			
COMANCHE	JEEP	86-92	18	18		38-180	36-180		21-180	21-180	2018	2018	16-180	16-180	MEGAVISION 18			
COMBI CARAVELLE	VOLKSWAGEN	75-02	16	18		38-160	36-160		21-160	21-160	2016	2016	16-160	16-160	MEGAVISION 16			
COMBI PANEL	VOLKSWAGEN	75-00	16	18		38-160	36-160		21-160	21-160	2016	2016	16-160	16-160	MEGAVISION 16			
COMMANDER	JEEP	05-08	18	18	13	38-180	38-180	38-150	21-180	21-180	21-150	2018	2018	2015	16-180	16-180	MEGAVISION 18	
COMPASS	JEEP	07-09	20	20	13	38-200	36-200		21-200	21-200	21-130	2020	2020	2013	16-200	16-200	MEGAVISION 20	
CONCORDE	CHRYSLER	97-02	24	22		30-240	36-220		21-240	21-220	2024	2022	16-240	16-220	MEGAVISION 24/22			
CONQUEST	PLYMOUTH	84-89	18	18		38-180	36-190		21-180	21-190	2018	2019	16-180	16-190	MEGAVISION 18			
CONTINENTAL	LINCOLN	83-88	20	20		38-200	38-200		21-200	21-200	2020	2020	16-200	16-200	MEGAVISION 20			
CONTINENTAL	LINCOLN	96-99	24	20		30-240	38-200		21-240	21-200	2024	2020	16-240	16-200	MEGAVISION 24/20			
CONTOUR	FORD	96-01	22	20		38-220	38-200		21-220	21-200	2022	2020	16-220	16-200	MEGAVISION 22/20			
COOPER	MINI	02-08	18	18		38-180	36-190		21-180	21-190	2018	2019	16-180	16-190				
CORDIA	MITSUBISHI	83-88	16	18		38-160	36-160		21-160	21-160	2018	2018	16-160	16-160	MEGAVISION 16			
CORDOBA	CHRYSLER	78-83	18	18		38-180	38-180		21-180	21-180	2018	2018	16-180	16-180	MEGAVISION 18			
CORDOBA	SEAT	01-08	21	18				30-219		21-190	2021	2019	16-210	16-190	MEGAVISION 19/21			



## Master Automotriz 2010

### Productos Gates \* FORMAS Y DIMENSIONES

VEHICULO	MARCA	AÑO	LONGITUD EN MILIMETROS	PILOTO	COPILOTO	TRASERO	E														
							E		E		E		E		E		E				
COROLLA	TOYOTA	95-01	20	18			35-200	38-180			21-220	21-180			2020	2018	16-200	16-180	MEGAVISION 20/18		
COROLLA	TOYOTA	02-08	24	18			30-240	38-180			21-240	21-180			2024	2018	16-240	16-180	MEGAVISION 24/18		
CORSA SEDAN	CHEVROLET	02-08	19	18			38-180	38-180			21-180	21-180			2018	2018	16-160	16-180	MEGAVISION 18		
CORSA HATCHBACK	CHEVROLET	02-08	18	18	18		38-180	38-180	38-160		21-180	21-180	21-160		2018	2018	2016	16-180	16-180	16-160	MEGAVISION 18
CORSAR	VOLKSWAGEN	83-90	18	18			38-180	38-180			21-180	21-180			2018	2018		16-180	16-180		MEGAVISION 18
CORSICA	CHEVROLET	87-95	19	18			38-190	38-190			21-190	21-190			2019	2019		16-190	16-190		MEGAVISION 19
CORVETTE	CHEVROLET	83-96	19	18			38-190	38-190			21-190	21-190			2019	2019		16-190	16-190		MEGAVISION 19
CORVETTE	CHEVROLET	97-06	22	22			22-1	22-1			21-220	21-220			2022	2022		16-220	16-220		MEGAVISION 22
COUGAR	MERCURY	83-88	18	18			38-180	38-180			21-180	21-180			2018	2018		16-180	16-180		MEGAVISION 18
COUGAR	MERCURY	89-89	22	22			30-221	30-221			21-220	21-220			2022	2022		16-220	16-220		MEGAVISION 22
COUGAR	MERCURY	00-02	21	19					30-219			21-190			2021	2019		16-210	16-190		MEGAVISION 19/21
COURIER	FORD	01-08	19	18			38-190	38-190			21-190	21-190			2019	2019		16-190	16-190		MEGAVISION 19
CROSSFIRE	CHRYSLER	04-06	22	18			30-221	38-190			21-220	21-190			2022	2019		16-220	16-190		MEGAVISION 21/19
CROSSFOX	VOLKSWAGEN	06-08	22	15			22-1	38-150			21-220	21-150			2022	2015		16-220	16-180		MEGAVISION 22/16
CROWN VICTORIA	FORD	92-99	22	22			30-221	30-221			21-220	21-220			2022	2022		16-220	16-220		MEGAVISION 22
CR-V	HONDA	02-06	21	20				38-200				21-200			2021	2020		16-210	16-200		
CR-V	HONDA	07-08	20	18			26-1	38-180				21-180			2016			16-260	16-180		
CTS	CADILLAC	04-07	22	22			30-221	30-221			21-220	21-220			2022	2022		16-220	16-220		MEGAVISION 22
CUTLASS	CHEVROLET	87-96	19	18			38-180	38-180			21-180	21-180			2018	2018		16-180	16-180		MEGAVISION 18
CUTLASS CIERA	OLDSMOBILE	84-92	18	18			38-180	38-180			21-180	21-180			2018	2018		16-180	16-180		MEGAVISION 18
CK-7	MAZDA	06-08	20	18			26-1	38-180				21-160			2016			16-260	16-160		
CK-9	MAZDA	06-08	28	17			26-1	38-160							2017			16-260	16-170		
D-150	DOODGE	73-87	19	18			38-180	38-180			21-180	21-180			2018	2018		16-180	16-180		MEGAVISION 18
D-250	DOODGE	88-93	18	18			38-180	38-180			21-180	21-180			2018	2018		16-180	16-180		MEGAVISION 18
D-350	DOODGE	88-93	18	18			38-180	38-180			21-180	21-180			2018	2018		16-180	16-180		MEGAVISION 18
D-600	DOODGE	90-94	18	18			38-180	38-180			21-180	21-180			2018	2018		16-180	16-180		MEGAVISION 18
DAKOTA	DOODGE	97-07	20	20			38-200	38-200			21-200	21-200			2020	2020		16-200	16-200		MEGAVISION 20
DART/VOLARE/MAGN	DOODGE	74-88	16	16			38-160	38-160			21-160	21-160			2016	2016		16-160	16-160		MEGAVISION 16
LIN	DATSUBUN	70-83	16	16			38-160	38-160			21-160	21-160			2016	2016		16-160	16-160		MEGAVISION 16
DAYTONA	DOODGE	84-83	18	18			38-180	38-180			21-180	21-180			2018	2018		16-180	16-180		MEGAVISION 18
DENALI	GMC	08-09	22	22			22-1	22-1			21-220	21-220			2022	2022		16-220	16-220		MEGAVISION 22
DERBY	VOLKSWAGEN	95-08	21	19					30-219			21-190			2021	2019		16-210	16-190		MEGAVISION 19/21
DEVILLE	CADILLAC	80-84	18	18			38-180	38-180			21-180	21-180			2018	2018		16-180	16-180		MEGAVISION 18
DEVILLE	CADILLAC	85-90	19	19			38-190	38-190			21-190	21-190			2019	2019		16-190	16-190		MEGAVISION 19
DEVILLE	CADILLAC	91-05	22	22			22-1	22-1			21-220	21-220			2022	2022		16-220	16-220		MEGAVISION 22
DIAMANTE	MITSUBISHI	93-95	19	19			38-190	38-190			21-190	21-190			2019	2019		16-190	16-190		MEGAVISION 19
DISCOVERY	LAND ROVER	97-07	18	18	18		35-180	38-180	38-150		21-180	21-180	21-150		2018	2018	2015	16-180	16-180		MEGAVISION 18
DURANGO	DOODGE	01-03	20	20			38-200	38-200			21-200	21-200			2020	2020		16-200	16-200		MEGAVISION 20
DURANGO	DOODGE	04-06	20	20			26-1	38-200				21-200			2020			16-260	16-200		
DYNASTY	DOODGE	88-94	18	18			38-180	38-180			21-180	21-180			2018	2018		16-180	16-180		MEGAVISION 18
E-320	MB	96-07	24	24	16		30-240	30-240	38-160	SUV2424	21-240	21-240	21-160		2024	2024	2016	16-240	16-240	16-160	MEGAVISION 24
E-420	MB	95-98	24	24			30-240	30-240		SUV2424	21-240	21-240			2024	2024		16-240	16-240		MEGAVISION 24
ECLIPSE	MITSUBISHI	90-95	20	20			38-200	38-200			21-200	21-200			2020	2020		16-200	16-200		MEGAVISION 20
ECLIPSE	MITSUBISHI	96-07	24	22	18		30-240	38-220	38-180		21-240	21-220	21-180		2024	2022	2018	16-240	16-220	16-180	MEGAVISION 24/22
ECONLINE VAN & WAGON	FORD	95-08	22	22			30-221	30-221		SUV2222	21-220	21-220			2022	2022		16-220	16-220		MEGAVISION 22
ECOSPORT	FORD	03-08	24	20	15				38-150	SUV2420	21-240	21-200	21-150		2024	2020	2015	16-240	16-200		MEGAVISION 24/20
EDGE	FORD	07-08	26	20			26-1	38-200				21-200			2020			16-260	16-200		
EIGHTY EIGHT	OLDSMOBILE	92-95	22	22			30-221	30-221			21-220	21-220			2022	2022		16-220	16-220		MEGAVISION 22





## Master Automotriz 2010

### Productos Gates \* FORMAS Y DIMENSIONES

VEHICULO	MARCA	AÑO	LONGITUD EN PULGADAS																
			PILOTO	COPILOTO	TRASERO														
ELDORADO	CADILLAC	80-85	18	18		38-180	38-180		21-180	21-180		2018	2018	16-180	16-180	MEGAVISION 18			
ELDORADO	CADILLAC	86-91	18	18		38-190	38-190		21-190	21-190		2019	2019	16-190	16-190	MEGAVISION 19			
ELDORADO	CADILLAC	92-04	22	22		22-1	22-1		21-220	21-220		2022	2022	16-220	16-220	MEGAVISION 22			
ELECTRA	BUICK	85-90	18	18		38-190	38-190		21-190	21-190		2019	2019	16-190	16-190	MEGAVISION 19			
ENCORE	RENAULT	84-86	18	18		38-180	38-180		21-180	21-180		2018	2018	16-180	16-180	MEGAVISION 18			
ENDEAVOR	MITSUBISHI	04-06	26	20	15		38-200	38-150		21-200	21-150		2020	2015	16-260	16-200	16-160		
ENDEAVOR	MITSUBISHI	04-06	26	20		26-1	38200			21-200			2020		16-260	16-200			
EQUINOX	CHEVROLET	05-07	24	20	15			38-150	SUV2420	21-240	21-200	21-150	2024	2020	2015	16-240	16-200	MEGAVISION 24/20	
ES250	LEXUS	88-91	21	18					30-219		21-190		2021	2019		16-210	16-190	MEGAVISION 19/21	
ES300	LEXUS	92-94	21	18					30-219		21-190		2021	2019		16-210	16-190	MEGAVISION 19/21	
ESCALADE	CADILLAC	02-06	22	18		30-221	38-160			21-220	21-160		2022	2018		16-220	16-160	MEGAVISION 22/16	
ESCAPE	FORD	01-07	20	18		38-200	38-180			21-220	21-180		2020	2018		16-200	16-180	MEGAVISION 20/18	
ESCORT/ZX3/WAGON	FORD	94-00	20	16		38-200	38-180			21-220	21-180		2020	2018		16-200	16-180	MEGAVISION 20/18	
ESTAQUITAS	NISSAN	94-07	21	20			38-200				21-200		2021	2020		16-210	16-200		
EUROSPORT	OLDSMOBILE	93-96	18	18		38-180	38-180			21-180	21-180		2018	2018		16-180	16-180	MEGAVISION 18	
EUROVAN	VOLKSWAGEN	00-05	21	21	18			38-160				21-160	2021	2021	2016	16-210	16-210	16-160	
EUROVAN TDI	VOLKSWAGEN	05-08	24	24		30-240	30-240		SUV2424	21-240	21-240		2024	2024		16-240	16-240	MEGAVISION 24	
EXCEL	HYUNDAI	90-94	18	18	16	38-180	38-180	38-180		21-180	21-180	21-180	2018	2018	2018	16-180	16-180	16-160	MEGAVISION 18
EXCURSION	FORD	00-06	20	20	16	38-200	38-200	38-160	SUV2020	21-200	21-200		2020	2020		16-200	16-200		MEGAVISION 20
EXPEDITION	FORD	97-07	22	22	16	30-221	30-221	38-160	SUV2222	21-220	21-220	21-160	2022	2022	2016	16-220	16-220	16-160	MEGAVISION 22
EXPERT	PEUGEOT	08-09	28	20		28-9	38-200				21-200			2020		16-280	16-200		
EXPLORER	FORD	91-01	18	18		38-180	38-180			21-180	21-180		2018	2018		16-180	16-180		MEGAVISION 18
EXPLORER	FORD	02-06	22	22	16	30-221	30-221	38-160	SUV2222	21-220	21-220	21-160	2022	2022	2016	16-220	16-220	16-160	MEGAVISION 22
EXPLORER	FORD	07-08	22	22	13	22-1	22-1			21-220	21-220	21-130	2022	2022	2013	16-220	16-220		MEGAVISION 22
EXPRESS VAN	CHEVROLET	98-08	22	22		30-221	30-221		SUV2222	21-220	21-220		2022	2022		16-220	16-220		MEGAVISION 22
F-150	FORD	82-96	18	18		38-180	38-180			21-180	21-180		2018	2018		16-180	16-180		MEGAVISION 18
F-150	FORD	97-06	22	22		30-221	30-221		SUV2222	21-220	21-220		2022	2022		16-220	16-220		MEGAVISION 22
F-250	FORD	86-95	18	18		38-180	38-180			21-180	21-180		2018	2018		16-180	16-180		MEGAVISION 18
F-250	FORD	82-96	18	18		38-180	38-180			21-180	21-180		2018	2018		16-180	16-180		MEGAVISION 18
F-250	FORD	97-07	22	22		30-221	30-221		SUV2222	21-220	21-220		2022	2022		16-220	16-220		MEGAVISION 22
F-350	FORD	85-94	22	22		30-221	30-221		SUV2222	21-220	21-220		2022	2022		16-220	16-220		MEGAVISION 22
F-350	FORD	88-07	18	18		38-180	38-180			21-180	21-180		2018	2018		16-180	16-180		MEGAVISION 18
F-450	FORD	97-07	20	20		38-200	38-200			21-200	21-200		2020	2020		16-200	16-200		MEGAVISION 20
F-550	FORD	01-08	20	20		38-200	38-200			21-200	21-200		2020	2020		16-200	16-200		MEGAVISION 20
F-600	FORD	81-85	18	18		38-180	38-180			21-180	21-180		2018	2018		16-180	16-180		MEGAVISION 18
FAIRMONT	FORD	78-83	18	18		38-160	38-160			21-160	21-160		2018	2018		16-160	16-160		MEGAVISION 16
FESTIVA	FORD	88-93	18	18	15	38-180	38-180	38-150		21-180	21-180	21-150	2018	2018	2015	16-180	16-180		MEGAVISION 18
FIERO	PONTIAC	84-88	16	18		38-180	38-180			21-180	21-180		2018	2018		16-180	16-180		MEGAVISION 18
FIESTA	FORD	98-02	18	18	19	38-180	38-180	38-190		21-180	21-180	21-190	2018	2018	2019	16-180	16-180	16-190	MEGAVISION 18
FIESTA	FORD	03-08	24	18	13	30-240	38-180			21-240	21-180	21-130	2024	2018	2013	16-240	16-180		MEGAVISION 24/18
FIREBRD	PONTIAC	82-92	18	18		38-180	38-180			21-180	21-180		2018	2018		16-180	16-180		MEGAVISION 18
FIREBRD	PONTIAC	93-01	24	24		30-240	30-240		SUV2424	21-240	21-240		2024	2024		16-240	16-240		MEGAVISION 24
FIRENZA	OLDSMOBILE	83-88	18	18		38-160	38-160			21-160	21-160		2016	2016		16-160	16-160		MEGAVISION 16
FIT	HONDA	05-06	24	16		30-240	38-160			21-240	21-160		2024	2016		16-240	16-160		
FJ CRUISER	TOYOTA	07-08	16	14		38-160	38-140			21-160	21-130		2016	2013		16-160			
FLEETWOOD	CADILLAC	81-80	18	18		38-190	38-190			21-190	21-190		2019	2019		16-190	16-190		MEGAVISION 19
FLEETWOOD	CADILLAC	91-98	22	22		30-221	30-221			21-220	21-220		2022	2022		16-220	16-220		MEGAVISION 22
FOCUS/ZX3/WAGON	FORD	00-07	22	18	15	30-221	38-190	38-150		21-220	21-190	21-150	2022	2019	2015	16-220	16-190		MEGAVISION 21/19



## Master Automotriz 2010

### Productos Gates \* FORMAS Y DIMENSIONES

VEHICULO	MARCA	ANO	LONGITUD EN PULGADAS		E		E		E		E		E					
FORESTER	SUBARU	06-08	21	19			30-219		21-190		2021	2019	16-210	16-190	MEGAVISION 19/21			
FORTWO	SMART	02-06	20	20	38-200	38-200			21-200	21-200	2020	2020	16-200	16-200	MEGAVISION 20			
FREELANDER	LAND ROVER	99-08	22	21	30-221	38-200			21-220	21-200	21-130	2022	2020	2013	16-220	16-200	MEGAVISION 22/20	
FREESTAR	FORD	04-08	24	23			38-180	SUV2420	21-240	21-200	21-160	2024	2020	2018	16-240	16-200	16-160	MEGAVISION 24/20
FRONTIER	NISSAN	86-04	19	19	38-190	38-190			21-190	21-190		2019	2019		16-190	16-190		MEGAVISION 19
FRONTIER	NISSAN	04-07	24	18	30-240	38-180			21-240	21-180		2024	2018		16-240	16-180		MEGAVISION 24/18
FUSION	FORD	06-08	24	18	30-240	38-180			21-240	21-180		2024	2018		16-240	16-180		MEGAVISION 24/18
G3	PONTIAC	05-08	22	18	30-221	38-160			21-220	21-160		2022	2018		16-220	16-160		MEGAVISION 22/18
G4	PONTIAC	03-05	21	19			30-219			21-190		2021	2019		16-210	16-190		MEGAVISION 19/21
G5	PONTIAC	06-08	22	18	30-221	38-160			21-220	21-160		2022	2018		16-220	16-160		MEGAVISION 22/18
G6	PONTIAC	04-07	21	19			30-219			21-190		2021	2019		16-210	16-190		MEGAVISION 19/21
GALANT	NISSAN	88-00	18	19	38-190	38-190			21-190	21-190		2019	2019		16-190	16-190		MEGAVISION 19
GALANT	NISSAN	03-05	24	18	30-240	38-180			21-240	21-180		2024	2018		16-240	16-180		MEGAVISION 24/18
GALANT	NISSAN	06-08	26	20	26-1	38-200				21-200		2020			16-260	16-200		MEGAVISION 26/20
GOL	VOLKSWAGEN	09-10	18	22	38-160	30-221			21-160	21-220		2018	2022		16-160	16-220		MEGAVISION 18/22
GOLF	VOLKSWAGEN	93-08	21	19			30-219			21-190		2021	2019		16-210	16-190		MEGAVISION 19/21
GOLF	VOLKSWAGEN	88-92	18	18	38-160	38-160			21-160	21-160		2018	2018		16-160	16-160		MEGAVISION 18
GOLFCABRIO	VOLKSWAGEN	93-04	21	19			30-219			21-190		2021	2019		16-210	16-190		MEGAVISION 19/21
GRAND AM	PONTIAC	85-94	19	19	38-190	38-190			21-190	21-190		2019	2019		16-190	16-190		MEGAVISION 19
GRAND AM	PONTIAC	99-05	22	18	30-221	38-160			21-220	21-160		2022	2018		16-220	16-160		MEGAVISION 22/18
GRAND CHEROKEE	JEEP	93-98	20	20	38-200	38-200			21-200	21-200	21-130	2020	2020	2013	16-200	16-200		MEGAVISION 20
GRAND CHEROKEE	JEEP	99-08	21	21			30-219					2021	2021	2013	16-210	16-210		MEGAVISION 21/13
GRAND MARQUIS	MERCURY	92-05	22	22	30-221	30-221			21-220	21-220		2022	2022		16-220	16-220		MEGAVISION 22
GRAND MARQUIS & LTD	MERCURY	70-84	18	18	38-180	38-180			21-180	21-180		2018	2018		16-180	16-180		MEGAVISION 18
GRAND PRIX	PONTIAC	82-96	20	20	38-200	38-200			21-200	21-200		2020	2020		16-200	16-200		MEGAVISION 20
GRAND PRIX	PONTIAC	97-01	22	22	30-221	30-221			21-220	21-220		2022	2022		16-220	16-220		MEGAVISION 22
GRAND VITARA	SUZUKI	06-08	19	19	38-190	38-190	38-150		21-190	21-190	21-150	2019	2019	2015	16-190	16-190		MEGAVISION 19
GRAND VOYAGER	PLYMOUTH	91-95	22	18	38-220	38-180			21-220	21-180		2022	2018		16-220	16-180		MEGAVISION 22/18
GRAND VOYAGER	PLYMOUTH	85-05	28	28	28-9	28-9	38-180	SUV2828			21-160			2018	16-280	16-280	16-100	MEGAVISION 28/18
GRANDIS	MITSUBISHI	06-08	23	22	28-9	30-221				21-220		2022			16-280	16-220		MEGAVISION 23/22
GREMLIN	VAM	74-83	16	16	38-160	38-160			21-160	21-160		2016	2016		16-160	16-160		MEGAVISION 16
GUAYIN	VAM	80-83	18	18	38-180	38-180			21-180	21-180		2018	2018		16-180	16-180		MEGAVISION 18
GUIA	FORD	81-84	18	18	38-180	38-180			21-180	21-180		2018	2018		16-180	16-180		MEGAVISION 18
H1	HUMMER	05-07	11	11	38-110	38-110			21-110	21-110		2011	2011					MEGAVISION 11
H-100	HYUNDAI	03-08	18	18	38-180	38-180			21-180	21-180		2018	2018		16-180	16-180		MEGAVISION 18
H2	HUMMER	06-08	16	11	38-160	38-160	38-110		21-160	21-160	21-110	2016	2016	2011	16-160	16-160		MEGAVISION 16
H3	HUMMER	06-08	17	13		38-160				21-160	21-130	2017	2016	2013	16-170	16-160		MEGAVISION 17/13
HIACE PANEL	TOYOTA	05-08	22	22	30-221	30-221			21-220	21-220		2022	2022		16-220	16-220		MEGAVISION 22
HIACE PASAJEROS	TOYOTA	05-08	20	20	38-200	38-200			21-200	21-200		2020	2020		16-200	16-200		MEGAVISION 20
HIKARI	NISSAN	88-92	18	18	38-180	38-180	38-180		21-180	21-180	21-180	2018	2018	2018	16-180	16-180	16-180	MEGAVISION 18
HILUX PICK UP	TOYOTA	04-05	18	18	38-180	38-180			21-180	21-180		2018	2018		16-180	16-180		MEGAVISION 18
HILUX PICK UP	TOYOTA	06-08	21	19			30-219			21-190		2021	2019		16-210	16-190		MEGAVISION 19/21
IBIZA	SEAT	01-07	21	14		38-140	30-219			21-190		2021	2019		16-210	16-190		MEGAVISION 19/21
ICHI VAN	NISSAN	88-94	18	18	38-180	38-180			21-180	21-180		2018	2018		16-180	16-180		MEGAVISION 18
IDEA ADVENTURE	FIAT	07-08	22	16	22-1	38-160			21-220	21-160		2022	2016		16-220	16-160		MEGAVISION 22/16
IKON	FORD	01-06	18	18	38-180	38-180			21-180	21-180		2018	2018		16-180	16-180		MEGAVISION 18
I-MARK	ISUZU	85-89	18	15	38-180	38-180	38-150		21-180	21-180	21-150	2018	2018	2015	16-180	16-180		MEGAVISION 18
IMPALA	CHEVROLET	85-89	18	18	38-180	38-180			21-180	21-180		2018	2018		16-180	16-180		MEGAVISION 18





# Master Automotriz 2010

## Productos Gates \* FORMAS Y DIMENSIONES

VEHICULO	MARCA	AÑO	LONGITUD EN PULGADAS			E															
			PILOTO	COPILOTO	TRASERO	E															
IMPALA	CHEVROLET	00-03	22	22		30-221	30-221			21-220	21-220			2022	2022			16-220	16-220	MEGAVISION 22	
IMPERIAL	CHRYSLER	81-90	18	18		38-180	38-180			21-180	21-180			2018	2018			16-180	16-180	MEGAVISION 18	
IMPRESA	SUBARU	93-00	20	18		38-200	38-180			21-220	21-180			2020	2018			16-200	16-180	MEGAVISION 20/18	
IMPRESA	SUBARU	01-07	22	16		30-221	38-180			21-220	21-160			2022	2016			16-220	16-160	MEGAVISION 22/16	
IMPRESA	SUBARU	08-09	24	16		30-240	38-180			21-240	21-160			2024	2016			16-240	16-160		
IMPULSE	ISUZU	90-94	22	22		30-221	30-221			21-220	21-220			2022	2022			16-220	16-220	MEGAVISION 22	
INFINITI I30	INFINITI	98-02	22	22		30-221	30-221			21-220	21-220			2022	2022			16-220	16-220	MEGAVISION 22	
INFINITI I35	INFINITI	02-04	26	17		26-1	38-180							2017				16-260	16-170		
INFINITI Q45	INFINITI	94-00	22	20		30-221	38-200			21-220	21-200			2022	2020			16-220	16-200	MEGAVISION 22/20	
INFINITI Q45	INFINITI	01-08	26	18		26-1	38-180				21-180			2018				16-260	16-180		
INTEGRA	ACURA	86-95	20	18	18	38-200	38-180	38-180		21-220	21-180	21-180		2020	2018	2018		16-200	16-180	16-180	MEGAVISION 20/18
INTEGRA	ACURA	96-01	22	18	19	38-220	38-180	38-190		21-220	21-180	21-190		2022	2018	2019		16-220	16-180	16-190	MEGAVISION 22/18
INTREPID	DOODGE	94-02	24	22		30-240	38-220			21-240	21-220			2024	2022			16-240	16-220	MEGAVISION 24/22	
JEEP	RAM	76-86	16	16		38-160	38-160			21-160	21-160			2016	2016			16-160	16-160	MEGAVISION 16	
JETTA	VOLKSWAGEN	80-92	18	16		38-180	38-180			21-180	21-160			2016	2016			16-180	16-160	MEGAVISION 16	
JETTA	VOLKSWAGEN	93-08	21	18					30-219		21-190			2021	2019			16-210	16-190	MEGAVISION 19/21	
JIMMY	GMC	86-94	16	16		38-160	38-160			21-160	21-160			2016	2016			16-160	16-160	MEGAVISION 16	
JIMMY	GMC	95-00	20	20	14	38-200	38-200	38-140		21-200	21-200			2020	2020			16-200	16-200	MEGAVISION 20	
JUSTY	SUBARU	90-94	18	16	14	38-180	38-180	38-140		21-180	21-180			2018	2018			16-180	16-180	MEGAVISION 18	
KA	FORD	03-07	19	16		38-190	38-160			21-190	21-160			2019	2016			16-190	16-160	MEGAVISION 19/16	
KANGOO	RENAULT	03-08	20	20	14	38-200	38-200	38-140		21-200	21-200			2020	2020			16-200	16-200	MEGAVISION 20	
LAGUNA	RENAULT	03-07	24	18		30-240	38-180			21-240	21-180			2024	2018			16-240	16-180	MEGAVISION 24/18	
LANCER	DOODGE	85-89	18	18	18	38-180	38-180	38-180		21-180	21-180	21-180		2018	2018	2018		16-180	16-180	16-180	MEGAVISION 18
LANCER	MITSUBISHI	03-08	24	18		30-240	38-180			21-240	21-180			2024	2018			16-240	16-180	MEGAVISION 24/18	
LAND CRUISER	TOYOTA	03-08	24	22	16	30-240	38-220	38-160		21-240	21-220	21-160		2024	2022	2016		16-240	16-220	16-160	MEGAVISION 24/22
LAND ROVER	LAND ROVER	06-08	22	20		30-221	38-200			21-220	21-200			2022	2020			16-220	16-200	MEGAVISION 22/20	
LASER	PLYMOUTH	84-89	18	18	18	38-180	38-180	38-180		21-180	21-180	21-180		2018	2018	2018		16-180	16-180	16-180	MEGAVISION 18
LASER	PLYMOUTH	90-94	20	20		38-200	38-200			21-200	21-200			2020	2020			16-200	16-200	MEGAVISION 20	
LEBARON	CHRYSLER	80-94	18	16		38-180	38-180			21-180	21-160			2016	2016			16-180	16-160	MEGAVISION 16	
LEGACY	SUBARU	90-94	20	18		38-200	38-180			21-220	21-180			2020	2018			16-200	16-180	MEGAVISION 20/18	
LEGACY	SUBARU	95-00	21	18					30-219		21-190			2021	2019			16-210	16-190	MEGAVISION 19/21	
LEGACY	SUBARU	06-08	24	18		30-240	38-180			21-240	21-180			2024	2018			16-240	16-180	MEGAVISION 24/18	
LEGEND	ACURA	87-95	22	18		38-220	38-180			21-220	21-180			2022	2018			16-220	16-180	MEGAVISION 22/18	
LEMANS	PONTIAC	88-94	18	16		38-180	38-180			21-180	21-180			2018	2018			16-180	16-180	MEGAVISION 18	
LEON	SEAT	01-07	21	18	18		38-150		30-219		21-190	21-150		2021	2019	2015		16-210	16-190	MEGAVISION 19/21	
LESABRE	BUICK	86-91	19	18		38-190	38-190			21-190	21-190			2019	2019			16-190	16-190	MEGAVISION 19	
LESABRE	BUICK	92-05	22	22		30-221	30-221			21-220	21-220			2022	2022			16-220	16-220	MEGAVISION 22	
LJ48	CHRYSLER	94-97	24	22		30-240	38-220			21-240	21-220			2024	2022			16-240	16-220	MEGAVISION 24/22	
LIBERTY	JEEP	03-08	18	18	11	38-180	38-190	38-110		21-190	21-190	21-110		2019	2019	2011		16-190	16-190	MEGAVISION 19	
LOBO	FORD	97-08	22	22		30-221	30-221			21-220	21-220			2022	2022			16-220	16-220	MEGAVISION 22	
LS	LINCOLN	00-07	24	19		30-240	38-190			21-240	21-190			2024	2019			16-240	16-190	MEGAVISION 24/19	
LS400	LEXUS	90-94	22	16		30-221	38-160			21-220	21-160			2022	2016			16-220	16-160	MEGAVISION 22/16	
LTD	FORD	84-86	18	18		38-180	38-180			21-180	21-180			2018	2018			16-180	16-180	MEGAVISION 18	
LUCINO	NISSAN	96-00	21	18					30-219		21-190			2021	2019			16-210	16-190	MEGAVISION 19/21	
LUMINA	CHEVROLET	90-94	20	20	14	38-200	38-200	38-140	SUV2020	21-200	21-200			2020	2020			16-200	16-200	MEGAVISION 20	
LUMINA	CHEVROLET	95-97	22	22	14	30-221	30-221	38-140	SUV2222	21-220	21-220			2022	2022			16-220	16-220	MEGAVISION 22	
LUMINA APV	CHEVROLET	90-96	24	24	14			38-140	SUV2424	21-240	21-240			2024	2024			16-240	16-240	MEGAVISION 24	
LUPO	VOLKSWAGEN	04-08	22	16		30-221	38-150			21-220	21-150			2022	2015			16-220	16-160	MEGAVISION 22/16	

# Master Automotriz 2010

## Productos Gates \* FORMAS Y DIMENSIONES

VEHICULO	MARCA	ANO	LONGITUD EN PULGADAS	E		E		E		E		E								
				PILOTO	COPILOTO	TRASERO														
LUV	CHEVROLET	97-06	18	18			38-180	38-180		21-180	21-180	2018	2018	16-180	16-180	MEGAVISION 18				
M3	BMW	95-02	21	18					30-219		21-190	2021	2019	16-210	16-190	MEGAVISION 19/21				
MAGNUM	CHRYSLER	80-84	16	18			38-180	38-180		21-180	21-180	2018	2018	16-180	16-180	MEGAVISION 16				
MALIBU	CHEVROLET	97-06	22	20			30-221	38-200		21-220	21-200	2022	2020	16-220	16-200	MEGAVISION 22/20				
MARINER	MERCURY	04-07	20	18			38-200	38-180		21-200	21-180	2020	2018	16-200	16-180	MEGAVISION 20/18				
MARK LT	LINCOLN	06-09	20	20			38-200	38-200		21-200	21-200	2020	2020	16-200	16-200	MEGAVISION 20				
MARK VI	LINCOLN	84-92	18	18			38-180	38-180		21-180	21-180	2018	2018	16-180	16-180	MEGAVISION 18				
MARK VIII	LINCOLN	93-96	22	22			30-221	30-221		21-220	21-220	2022	2022	16-220	16-220	MEGAVISION 22				
MATIZ	PONTIAC	03-08	21	18	14		38-180	38-140			21-180	2021	2016	16-210	16-180	MEGAVISION 21/16				
MATRIX	TOYOTA	03-07	21	18			38-180				21-180	2021	2018	16-210	16-180	MEGAVISION 21				
MAXICAB	CHEVROLET	91-94	22	22			30-221	30-221		21-220	21-220	2022	2022	16-220	16-220	MEGAVISION 22				
MAXIMA	NISSAN	85-88	18	18			38-180	38-180		21-180	21-180	2019	2019	16-180	16-180	MEGAVISION 18				
MAXIMA	NISSAN	89-94	21	20			38-200				21-200	2021	2020	16-210	16-200	MEGAVISION 21				
MAXIMA	NISSAN	95-99	22	20			30-221	38-200		21-220	21-200	2022	2020	16-220	16-200	MEGAVISION 22/20				
MAXIMA	NISSAN	00-08	26	10			26-1	38-160			21-180	2016		16-260	16-180	MEGAVISION 26				
MAZDA 3	MAZDA	06-08	21	18					30-219		21-190	2021	2019	16-210	16-190	MEGAVISION 19/21				
MAZDA 5	MAZDA	06-08	26	16			26-1	38-160			21-160	2016		16-260	16-160	MEGAVISION 26				
MAZDA 6	MAZDA	07-08	22	18			38-220	38-180		21-220	21-180	2022	2018	16-220	16-180	MEGAVISION 22/18				
MDX	ACURA	05-08	24	22			30-240	38-220		21-240	21-220	2024	2022	16-240	16-220	MEGAVISION 24/22				
MDX	ACURA	05-08	24	20			30-240	38-200	SUV2420	21-240	21-200	2024	2020	16-240	16-200	MEGAVISION 24/20				
MEGANE I Y II	RENAULT	01-07	22	20			30-221	38-200		21-220	21-200	2022	2020	16-220	16-200	MEGAVISION 22/20				
MERIVA	CHEVROLET	03-06	24	24	16		30-240	30-240	38-160	SUV2424	21-240	21-240	21-180	2024	2024	2018	16-240	16-240	16-180	MEGAVISION 24
MG TF	MG ROVER	03-06	18	18			38-180	38-180		21-180	21-180	2018	2018	16-180	16-180	MEGAVISION 18				
MG ZR	MG ROVER	03-06	18	18			38-180	38-180		21-180	21-180	2018	2018	16-180	16-180	MEGAVISION 18				
MG ZT	MG ROVER	03-06	22	22			22-1	22-1		21-220	21-220	2022	2022	16-220	16-220	MEGAVISION 22				
MIATA	MAZDA	90-94	18	18			38-180	38-180		21-180	21-180	2018	2018	16-180	16-180	MEGAVISION 18				
MICRA	NISSAN	82-91	18	18			38-180	38-180		21-180	21-180	2018	2018	16-180	16-180	MEGAVISION 18				
MICRA	NISSAN	05-08	20	18			38-200	38-180		21-200	21-180	2020	2018	16-200	16-180	MEGAVISION 20/18				
MILAN	MERCURY	06-08	24	18			30-240	38-190		21-240	21-190	2024	2019	16-240	16-190	MEGAVISION 24/18				
MILLENNIA	MAZDA	95-97	21	20				38-200			21-200	2021	2020	16-210	16-200	MEGAVISION 21				
MKX	LINCOLN	07-08	26	20			26-1	38-200			21-200	2020		16-260	16-200	MEGAVISION 26				
MKX	LINCOLN	07-09	24	18			30-240	38-180		21-240	21-180	2024	2018	16-240	16-180	MEGAVISION 24/18				
MKZ	LINCOLN	05-09	24	18			30-240	38-180		21-240	21-180	2024	2018	16-240	16-180	MEGAVISION 24/18				
MKZ	LINCOLN	07-08	24	18			30-240	38-190		21-240	21-190	2024	2019	16-240	16-190	MEGAVISION 24/18				
ML-320	MB	98-03	22	22	16		30-221	30-221	38-160	SUV2222	21-220	21-220	21-160	2022	2022	2018	16-220	16-220	16-160	MEGAVISION 22
ML-350	MB	03-07	22	22			30-221	30-221		SUV2222	21-220	21-220		2022	2022		16-220	16-220		MEGAVISION 22
ML-430	MB	97-07	22	22	16		30-221	30-221	38-160	SUV2222	21-220	21-220	21-160	2022	2022	2018	16-220	16-220	16-160	MEGAVISION 22
ML-500	MB	02-07	22	22			30-221	30-221		SUV2222	21-220	21-220		2022	2022		16-220	16-220		MEGAVISION 22
ML-55	MB	01-03	22	22			30-221	30-221		SUV2222	21-220	21-220		2022	2022		16-220	16-220		MEGAVISION 22
MONACO	DODGE	78-96	18	18			38-180	38-180		21-180	21-180	2018	2018	16-180	16-180	MEGAVISION 18				
MONDEO	FORD	03-07	21	18					30-219		21-190	2021	2019	16-210	16-190	MEGAVISION 19/21				
MONTANA	PONTIAC	05-08	24	22	16		30-240	38-220	38-160	21-240	21-220	21-180	2024	2022	2018	16-240	16-220	16-180	MEGAVISION 24/22	
MONTECARLO	CHEVROLET	80-86	18	18			38-180	38-180		21-180	21-180	2018	2018	16-180	16-180	MEGAVISION 18				
MONTERO	NISSAN	88-91	18	16			38-180	38-160		21-180	21-160	2016	2016	16-180	16-160	MEGAVISION 18				
MONTERO	MITSUBISHI	03-07	20	20	18		38-200	38-200	38-180	SUV2020	21-200	21-200	21-180	2020	2020	2018	16-200	16-200	16-180	MEGAVISION 20
MONTERO	MITSUBISHI	92-02	18	18			38-180	38-180		21-180	21-180	2019	2019	16-180	16-180	MEGAVISION 18				
MOUNTAINEER	MERCURY	97-01	18	18	14		38-180	38-180	38-140	21-180	21-180	2018	2018	16-180	16-180	MEGAVISION 18				
MOUNTAINEER	MERCURY	02-04	22	22	16		30-221	30-221	38-160	SUV2222	21-220	21-220	21-160	2022	2022	2018	16-220	16-220	16-160	MEGAVISION 22



## Master Automotriz 2010

### Productos Gates \* FORMAS Y DIMENSIONES

		M			PILOTO			COPILOTO			TRASERO			E											
VEHICULO	MARCA	AÑO	LONGITUD EN PULGADAS			E																			
MOUNTAINEER	MERCURY	05-08	20	20	18	38-200	38-200	38-180	SUV2020	21-200	21-200	21-160	2020	2020	2018	16-200	16-200	16-160	MEGAVISION 20						
MPV	MAZDA	89-99	22	20	18	30-221	38-200	38-180		21-220	21-200	21-160	2022	2020	2018	18-220	16-200	16-160	MEGAVISION 22/20						
MR2 SPYDER	TOYOTA	05-08	20	19		38-200	38-190			21-200	21-190		2020	2019		16-200	16-190		MEGAVISION 20/18						
MURANO	NISSAN	04-08	26	19	14	26-1	38-190	38-140			21-190			2019		16-260	16-190		MEGAVISION 22/18						
MUSTANG	FORD	84-73	18	18		38-180	38-160			21-160	21-160		2018	2016		16-160	16-160		MEGAVISION 16						
MUSTANG	FORD	74-81	18	18		38-180	38-180			21-180	21-180		2018	2018		16-180	16-180		MEGAVISION 18						
MUSTANG	FORD	84-93	18	16		38-180	38-160			21-160	21-160		2016	2016		16-160	16-160		MEGAVISION 16						
MUSTANG	FORD	94-88	22	20		30-221	38-200			21-220	21-200		2022	2020		18-220	16-200		MEGAVISION 22/20						
MUSTANG	FORD	99-07	20	20		38-200	38-200			21-200	21-200		2020	2020		16-200	16-200		MEGAVISION 20						
MX-3	MAZDA	92-00	21	18		38-180					21-180		2021	2018		16-210	16-180								
MX-5	MAZDA	06-06	18	18		38-180	38-180			21-180	21-180		2018	2018		16-180	16-180		MEGAVISION 18						
MX-5 MIATA	MAZDA	06-08	18	18		38-180	38-180			21-180	21-180		2018	2018		16-180	16-180		MEGAVISION 18						
MX-6	MAZDA	88-92	19	19		38-190	38-190			21-190	21-190		2019	2019		16-190	16-190		MEGAVISION 19						
MYSTIQUE	MERCURY	95-00	22	20		30-221	38-200			21-220	21-200		2022	2020		16-220	16-200		MEGAVISION 22/20						
NAVAJO	MAZDA	91-95	18	18	14	38-180	38-180	38-140		21-180	21-180		2018	2018		16-180	16-180		MEGAVISION 18						
NAVIGATOR	LINCOLN	98-07	20	20	16	38-200	38-200	38-180	SUV2020	21-200	21-200	21-160	2020	2020	2018	16-200	16-200	16-160	MEGAVISION 20						
NEON	DODGE	95-98	21	18		38-160					21-180		2021	2018		16-210	16-180								
NEON	DODGE	99-05	22	18		38-220	38-190			21-220	21-190		2022	2019		16-220	16-190		MEGAVISION 22/18						
NEW YORKER	CHRYSLER	83-97	18	18		38-180	38-180			21-180	21-180		2018	2018		16-180	16-180		MEGAVISION 18						
NINETY EIGHT	OLDSMOBILE	85-90	19	19		38-190	38-190			21-190	21-190		2019	2019		16-190	16-190		MEGAVISION 19						
NINETY EIGHT	OLDSMOBILE	91-95	22	22		30-221	30-221			21-220	21-220		2022	2022		16-220	16-220		MEGAVISION 22						
NITRO	DODGE	07-09	19	19		38-190	38-190			21-190	21-190		2019	2019		16-190	16-190		MEGAVISION 19						
NOVA	CHEVROLET	85-88	16	16		38-160	38-160			21-160	21-160		2016	2016		16-160	16-160		MEGAVISION 16						
NSX	ACURA	91-05	22	21		30-221				21-220			2022	2021		16-220	16-210		MEGAVISION 22/20						
ODYSSEY	HONDA	95-99	24	24	15			38-150	SUV2424	21-240	21-240	21-150	2024	2024	2015	16-240	16-240	16-160	MEGAVISION 24						
ODYSSEY	HONDA	00-06	24	20	18			38-180	SUV2420	21-240	21-200	21-180	2024	2020	2016	16-240	16-200	16-160	MEGAVISION 24/20						
ODYSSEY	HONDA	07-09	26	22		26-1	30-221				21-220			2022		16-260	16-220								
OMEGA	OLDSMOBILE	82-84	18	18		38-180	38-180			21-180	21-180		2018	2018		16-180	16-180		MEGAVISION 18						
OPTRA	CHEVROLET	08-09	22	18		30-221	38-190			21-220	21-190		2022	2019		16-220	16-190		MEGAVISION 22/18						
OUTBACK	SUBARU	06-08	24	18		30-240	38-180			21-240	21-180		2024	2018		16-240	16-180		MEGAVISION 24/18						
OUTLANDER	MITSUBISHI	04-06	22	19	14	38-220	38-190	38-140		21-220	21-190		2022	2019		16-220	16-190		MEGAVISION 22/18						
OUTLANDER	MITSUBISHI	07-09	23	21		30-240																			
PACIFICA	CHRYSLER	04-07	22	22	14	30-221	30-221	38-140		21-220	21-220		2022	2022		16-220	16-220		MEGAVISION 22						
PALIO	FIAT	04-08	24	18		30-240	38-180			21-240	21-180		2024	2018		16-240	16-180		MEGAVISION 24/18						
PANDA	FIAT	07-09	21	19					30-219		21-190		2021	2019		16-210	16-190		MEGAVISION 19/21						
PARISIENNE	PONTIAC	83-86	18	18		38-180	38-180			21-180	21-180		2018	2018		16-180	16-180		MEGAVISION 18						
PARK AVENUE	BUICK	91-05	22	22		30-221	30-221			21-220	21-220		2022	2022		16-220	16-220		MEGAVISION 22						
PARTNER	PEUGEOT	03-08	22	22		30-221	30-221			21-220	21-220		2022	2022		16-220	16-220		MEGAVISION 22						
PASSAT	VOLKSWAGEN	96-09	21	19					30-219		21-190		2021	2019		16-210	16-190		MEGAVISION 19/21						
PATHFINDER	NISSAN	87-94	19	19	13	38-190	38-190			21-190	21-190		2019	2019	2013	16-190	16-190		MEGAVISION 19						
PATHFINDER	NISSAN	97-05	22	21	13	30-221				21-220			2022	2021	2013	16-220	16-210		MEGAVISION 22/20						
PATHFINDER	NISSAN	05-08	24	18	13	30-240	38-180			21-240	21-180		2024	2018	2013	16-240	16-180		MEGAVISION 24/18						
PATRIOT	JEEP	07-09	21	21	11			38-110				21-110	2021	2021	2011	16-210	16-210								
PHANTOM	CHRYSLER	87-94	18	18		38-180	38-180			21-180	21-180		2018	2018		16-180	16-180		MEGAVISION 18						
PHOENIX	PONTIAC	80-84	18	16		38-180	38-160			21-180	21-180		2018	2018		16-180	16-180		MEGAVISION 18						
PICK UP	ISUZU	90-95	18	18		38-180	38-180			21-180	21-180		2018	2018		16-180	16-180		MEGAVISION 18						
PICK UP	NISSAN	89-78	15	15		38-150	38-150			21-150	21-150		2015	2015					MEGAVISION 15						
PICK UP	NISSAN	79-93	16	16		38-160	38-160			21-160	21-160		2016	2016		16-160	16-160		MEGAVISION 16						



# Master Automotriz 2010

## Productos Gates \* FORMAS Y DIMENSIONES

VEHICULO	MARCA	AÑO	LONGITUD EN PULGADAS		P		E		E		E		E					
			PILOTO	COPILOTO	TRASERO													
PICK UP	NISSAN	86-97	18	18		38-190	38-190		21-190	21-190		2019	2019	16-190	16-190	MEGAVISION 19		
PICK UP	VAM	84-86	18	18		38-160	38-160		21-180	21-160		2018	2018	16-160	16-160	MEGAVISION 18		
PICK UP	NISSAN	94-07	21	20			38-200			21-200		2021	2020	16-210	16-200			
PILOT	HONDA	03-07	24	21		30-240	38-201			21-240		2024	2021	16-240	16-210	MEGAVISION 24/20		
PLATINA	NISSAN	02-09	20	18		38-200	38-160		21-200	21-160		2020	2018	16-200	16-160	MEGAVISION 20/18		
POINTER	VOLKSWAGEN	88-00	20	20		38-200	38-200	SUV2020	21-200	21-200		2020	2020	16-200	16-200	MEGAVISION 20		
POINTER	VOLKSWAGEN	00-08	21	18	18		38-160	30-219		21-190	21-160	2021	2019	2016	16-210	16-190	16-160	MEGAVISION 19/21
POLO	VOLKSWAGEN	03-06	21	18				30-219		21-190		2021	2019		16-210	16-190		MEGAVISION 19/21
PRECIE	MITSUBISHI	89-93	18	18	18	38-180	38-180	38-160	21-180	21-180	21-160	2018	2018	2016	16-180	16-160	16-160	MEGAVISION 18
PRELUDE	HONDA	86-91	20	18		38-200	38-190		21-200	21-190		2020	2019		16-200	16-190		MEGAVISION 20/18
PRELUDE	HONDA	92-96	22	18		38-220	38-180		21-220	21-180		2022	2018		16-220	16-180		MEGAVISION 22/18
PREMIER	EAGLE	89-92	18	18		38-190	38-190		21-190	21-190		2019	2019		16-190	16-190		MEGAVISION 19
PRIZM	GEO	89-92	18	18		38-190	38-190		21-190	21-190		2019	2019		16-190	16-190		MEGAVISION 19
PROBE	FORD	89-96	20	18		38-200	38-160		21-200	21-180		2020	2018		16-200	16-180		MEGAVISION 20/18
PROTEGE	MAZDA	90-97	21	18			38-180			21-180		2021	2018		16-210	16-180		
PT CRUISER	CHRYSLER	00-08	20	21	18	38-200		38-160	21-200		21-160	2020	2021	2016	16-200	16-210	16-160	
PULSAR	NISSAN	87-90	21	21								2021	2021		16-210	16-210		
QUEST	NISSAN	87-04	22	22	14	30-221	30-221	38-140	21-220	21-220		2022	2022		16-220	16-220		MEGAVISION 22
QUEST	NISSAN	05-08	28	18	14	28-9	38-180	38-140		21-180			2018		16-280	16-180		
R-12	RENAULT	72-83	18	16		38-160	38-160		21-160	21-160		2016	2016		16-160	16-160		MEGAVISION 16
R-18	RENAULT	79-88	18	16		38-160	38-160		21-160	21-160		2016	2016		16-160	16-160		MEGAVISION 16
RAM 1500	DODGE	95-01	20	20		38-200	38-200	SUV2020	21-200	21-200		2020	2020		16-200	16-200		MEGAVISION 20
RAM 1500	DODGE	02-07	24	24		30-240	30-240	SUV2424	21-240	21-240		2024	2024		16-240	16-240		MEGAVISION 24
RAM 2500	DOODGE	95-01	20	20		38-200	38-200	SUV2020	21-200	21-200		2020	2020		16-200	16-200		MEGAVISION 20
RAM 2500	DODGE	02-07	24	24		30-240	30-240	SUV2424	21-240	21-240		2024	2024		16-240	16-240		MEGAVISION 24
RAM 3500	DODGE	95-01	20	20		38-200	38-200	SUV2020	21-200	21-200		2020	2020		16-200	16-200		MEGAVISION 20
RAM 3500 MAXI	DODGE	95-04	20	20		38-200	38-200	SUV2020	21-200	21-200		2020	2020		16-200	16-200		MEGAVISION 20
RAM 4000	DODGE	94-96	18	18		38-180	38-180		21-180	21-180		2018	2018		16-180	16-180		MEGAVISION 18
RAM 4000	DODGE	97-06	20	20		38-200	38-200	SUV2020	21-200	21-200		2020	2020		16-200	16-200		MEGAVISION 20
RAM 50	DODGE	88-93	18	18		38-180	38-180		21-180	21-180		2018	2018		16-180	16-180		MEGAVISION 18
RAM 6500	DODGE	97-00	18	18		38-180	38-180		21-180	21-180		2018	2018		16-180	16-180		MEGAVISION 18
RAM 7000	DODGE	97-00	18	18		38-180	38-180		21-180	21-180		2018	2018		16-180	16-180		MEGAVISION 18
RAM CHARGER	DODGE	87-02	18	18		38-180	38-180		21-180	21-180		2018	2018		16-180	16-180		MEGAVISION 18
RAM RUNNER	DODGE	96-00	20	20		38-200	38-200	SUV2020	21-200	21-200		2020	2020		16-200	16-200		MEGAVISION 20
RAM VAN 1500	DODGE	96-98	18	18		38-180	38-180		21-180	21-180		2018	2018		16-180	16-180		MEGAVISION 18
RAM VAN 1500	DODGE	99-04	18	18		38-180	38-190		21-190	21-190		2019	2019		16-190	16-190		MEGAVISION 19
RAM VAN 2500	DODGE	96-98	18	18		38-180	38-180		21-180	21-180		2018	2018		16-180	16-180		MEGAVISION 18
RAM VAN 2500	DODGE	99-04	18	18		38-190	38-190		21-190	21-190		2019	2019		16-190	16-190		MEGAVISION 19
RAM VAN 3500	DODGE	96-98	18	18		38-180	38-180		21-180	21-180		2018	2018		16-180	16-180		MEGAVISION 18
RAM VAN 3500	DODGE	99-04	18	18		38-190	38-190		21-190	21-190		2019	2019		16-190	16-190		MEGAVISION 19
RAM WAGON	DODGE	94-03	18	18		38-180	38-180		21-180	21-180		2018	2018		16-180	16-180		MEGAVISION 18
RAMBLER	VAM	70-74	18	16		38-160	38-160		21-160	21-160		2016	2016		16-160	16-160		MEGAVISION 16
RANGE ROVER	LAND ROVER	87-07	22	22	18	30-221	30-221	38-180	21-220	21-220	21-180	2022	2022	2018	16-220	16-220	16-160	MEGAVISION 22
RANGER	FORD	85-09	18	18		38-180	38-180		21-180	21-180		2018	2018		16-180	16-180		MEGAVISION 18
RAV 4	TOYOTA	01-05	22	18	14	30-221	38-190	38-140	21-220	22-190		2022	2019		16-220	16-190		MEGAVISION 22/19
RAV 4	TOYOTA	06-09	24	17		30-240	38-160		21-240	21-160		2024	2017		16-240	16-170		MEGAVISION 24/18
RDX	ACURA	06-08	24	16		30-240	38-160		21-240	21-160		2024	2016		16-240	16-160		
REGAL	BUICK	88-98	20	20		38-200	38-200	SUV2020	21-200	21-200		2020	2020		16-200	16-200		MEGAVISION 20





## Master Automotriz 2010 Productos Gates \* FORMAS Y DIMENSIONES

VEHICULO	MARCA	AÑO	LONGITUD EN PULGADAS															
RELIANT	PLYMOUTH	88-89	16	16	35-160	38-180			21-190	21-190	2016	2016	16-160	16-160	MEGAVISION 16			
RIDGELINE	HONDA	06-08	24	20	30-240	38-200	SUV2420		21-240	21-200	2024	2020	16-240	16-200	MEGAVISION 24/20			
RL	ACURA	06-08	26	18	28-9	38-180			21-180		2018		16-280	16-180				
RL	ACURA	05-08	28	18	28-9	38-180			21-180		2018		16-280	16-180				
ROADMASTER	BUICK	92-96	22	22	30-221	30-221			21-220	21-220	2022	2022	2017	16-220	16-220	16-170	MEGAVISION 22	
ROADSTER	SMART	04-06	21	21							2021	2021	16-210	16-210				
ROCKY	DAIHATSU	88-92	16	16	35-160	38-160	38-140		21-160	21-160	2016	2016	16-160	16-160	MEGAVISION 16			
RODEO	ISUZU	91-97	18	18	38-180	38-180			21-180	21-180	2018	2018	16-180	16-180	MEGAVISION 18			
ROGUE	NISSAN	07-09	26	14	26-1	38-140							16-260	16-160				
ROYALE	OLDSMOBILE	86-90	19	18	38-190	38-190			21-190	21-190	2019	2019	16-190	16-190	MEGAVISION 19			
R86	AUDI	03-07	22	22	30-221	30-221			21-220	21-220	2022	2022	16-220	16-220	MEGAVISION 22			
S-10	CHEVROLET	82-93	18	18	38-180	38-180			21-180	21-180	2016	2016	16-180	16-180	MEGAVISION 16			
S-10	CHEVROLET	84-04	20	20	38-200	38-200	SUV2020		21-200	21-200	2020	2020	16-200	16-200	MEGAVISION 20			
S-15	CHEVROLET	86-93	19	16	38-160	38-160			21-160	21-160	2016	2016	16-160	16-160	MEGAVISION 16			
S4	AUDI	04-07	21	21							2021	2021	16-210	16-210				
S40	VOLVO	99-06	21	18			30-219		21-190		2021	2019	16-210	16-190	MEGAVISION 19/21			
S40	VOLVO	99-07	21	20		38-200			21-200		2021	2020	16-210	16-200				
S6	AUDI	04-07	22	22	30-221	30-221			21-220	21-220	2022	2022	16-220	16-220	MEGAVISION 22			
S60	VOLVO	01-07	24	22	30-240	38-220			21-240	21-220	2024	2022	16-240	16-220	MEGAVISION 24/22			
S80	VOLVO	00-04	24	22	30-240	38-220			21-240	21-220	2024	2022	16-240	16-220	MEGAVISION 24/22			
S80	VOLVO	99-07	24	22	30-240	38-220			21-240	21-220	2024	2022	16-240	16-220	MEGAVISION 24/22			
SABLE	MERCURY	86-93	20	20	38-200	38-200	SUV2020		21-200	21-200	2020	2020	16-200	16-200	MEGAVISION 20			
SABLE	MERCURY	94-05	24	20	30-240	38-200	SUV2420		21-240	21-200	2024	2020	16-240	16-200	MEGAVISION 24/20			
SAFARI	GMC	86-88	18	18	38-180	38-180			21-180	21-180	2018	2018	16-180	16-180	MEGAVISION 18			
SAKURA	NISSAN	81-84	18	18	38-180	38-180			21-180	21-180	2018	2018	16-180	16-180	MEGAVISION 18			
SAMURAI	NISSAN	84-87	16	16	38-160	38-160			21-160	21-160	2016	2016	16-160	16-160	MEGAVISION 16			
SC300	LEXUS	92-97	21	20		38-200			21-200		2021	2020	16-210	16-200				
SCENIC	RENAULT	01-07	24	16	30-240	38-160			21-240	21-160	2024	2016	16-240	16-160				
SEBRING	CHRYSLER	97-99	24	22	30-240	38-220			21-240	21-220	2024	2022	16-240	16-220	MEGAVISION 24/22			
SEBRING	CHRYSLER	00-04	22	22	30-221	30-221			21-220	21-220	2022	2022	16-220	16-220	MEGAVISION 22			
SEDAN	VOLKSWAGEN	72-03	11	11	38-110	38-110			21-110	21-110	2011	2011			MEGAVISION 11			
SEDAN 100	NISSAN	68-85	16	16	38-160	38-160			21-160	21-160	2016	2016	16-160	16-160	MEGAVISION 16			
SENTRA	NISSAN	87-90	18	18	38-180	38-180			21-180	21-180	2018	2018	16-180	16-180	MEGAVISION 18			
SENTRA	NISSAN	91-94	20	18	38-200	38-190			21-200	21-190	2020	2019	16-200	16-190	MEGAVISION 20/18			
SENTRA	NISSAN	95-99	21	19			30-219		21-190		2021	2019	16-210	16-190	MEGAVISION 19/21			
SENTRA	NISSAN	00-06	22	16	30-221	38-160			21-220	21-160	2022	2016	16-220	16-160	MEGAVISION 22/16			
SENTRA	NISSAN	07-09	26	17	26-1	38-160					2017		16-260	16-170				
SEQUOIA	TOYOTA	07-09	19	14	38-190	38-190	38-140		21-190	21-190	2019	2019	16-190	16-190	MEGAVISION 19			
SEVILLE	CADILLAC	80-85	18	18	38-180	38-180			21-180	21-180	2018	2018	16-180	16-180	MEGAVISION 18			
SEVILLE	CADILLAC	86-87	19	18	38-190	38-190			21-190	21-190	2019	2019	16-190	16-190	MEGAVISION 19			
SEVILLE	CADILLAC	92-04	22	22	30-221	30-221			21-220	21-220	2022	2022	16-220	16-220	MEGAVISION 22			
SHADOW	DOGE	87-93	18	16	38-180	38-180			21-180	21-180	2018	2018	16-180	16-180	MEGAVISION 18			
SHADOW	CHRYSLER	88-90	18	18	38-180	38-180			21-180	21-180	2018	2018	16-180	16-180	MEGAVISION 18			
SHARAN	VOLKSWAGEN	03-07	28	28	26-8	28-9	38-160	SUV2828		21-160		2016	16-260	16-280	16-160			
SIENNA	TOYOTA	03-08	26	16	26-1	38-180	38-160		21-180	21-160	2018	2016	16-260	16-180	16-160			
SILHOUTTE	OLDSMOBILE	90-95	24	24		38-160	SUV2424		21-240	21-240	21-160	2024	2024	2016	16-240	16-240	16-160	MEGAVISION 24
SILVERADO	CHEVROLET	95-98	18	16	38-180	38-180			21-180	21-180	2018	2018	16-180	16-180	MEGAVISION 18			
SILVERADO	CHEVROLET	99-06	22	22	30-221	30-221			21-220	21-220	2022	2022	16-220	16-220	MEGAVISION 22			



# Master Automotriz 2010

## Productos Gates \* FORMAS Y DIMENSIONES

		S		PILOTO		COPILOTO		TRASERO											
VEHICULO	MARCA	AÑO	LONGITUD EN PULGADAS		E		E		E		E		E		E				
SKYHAWK	BUICK	82-89	18	18	38-160	38-180			21-160	21-160			2016	2016	16-160	16-160	MEGAVISION 16		
SKYLARK	BUICK	82-85	18	18	38-180	38-180			21-180	21-180			2018	2018	16-180	16-180	MEGAVISION 18		
SKYLARK	BUICK	86-96	19	18	38-190	38-190			21-190	21-190			2019	2019	16-190	16-190	MEGAVISION 19		
SL-320	MB	95-97	24	24	30-240	30-240		SUV2424	21-240	21-240			2024	2024	16-240	16-240	MEGAVISION 24		
SL-500	MB	84-98	24	24	30-240	30-240		SUV2424	21-240	21-240			2024	2024	16-240	16-240	MEGAVISION 24		
SL-500	MB	99-04	22	22	30-221	30-221		SUV2222	21-220	21-220			2022	2022	16-220	16-220	MEGAVISION 22		
SL-600	MB	96-07	24	24	30-240	30-240		SUV2424	21-240	21-240			2024	2024	16-240	16-240	MEGAVISION 24		
SLK-230	MB	97-00	22	22	30-221	30-221		SUV2222	21-220	21-220			2022	2022	16-220	16-220	MEGAVISION 22		
SLK-320	MB	01-07	22	22	30-221	30-221		SUV2222	21-220	21-220			2022	2022	16-220	16-220	MEGAVISION 22		
SLX	ACURA	96-99	20	20	16	38-200	38-200	38-160	SUV2020	21-200	21-200	21-160	2020	2020	2016	16-200	16-200	16-160	MEGAVISION 20
SMART TURBO	SMART	03-06	21	21									2021	2021		16-210	16-210		
SOLARA	TOYOTA	05-08	22	19	30-221	38-190			21-220	22-190			2022	2019		16-220	16-190		MEGAVISION 22/18
SOLSTICE	PONTIAC	05-08	16	22	38-160	30-221			21-160	21-220			2016	2022		16-160	16-220		
SONOMA	GMC	90-96	16	16	38-160	38-160			21-160	21-160			2016	2016		16-160	16-160		MEGAVISION 16
SONORA	CHEVROLET	00-08	22	22	30-221	30-221		SUV2222	21-220	21-220			2022	2022		16-220	16-220		MEGAVISION 22
SPACE STAR	MITSUBISHI	03-05	22	22	14	30-221	30-221	38-140	SUV2222	21-220	21-220		2022	2022		16-220	16-220		MEGAVISION 22
SPECTRUM	CHEVROLET	87-90	18	18	38-180	38-180			21-180	21-180			2018	2018		16-180	16-180		MEGAVISION 18
SPECTRUM	GEO	87-90	18	18	38-180	38-180			21-180	21-180			2018	2018		16-180	16-180		MEGAVISION 18
SPIRIT	CHRYSLER	90-94	18	18	38-180	38-180			21-180	21-180			2018	2018		16-180	16-180		MEGAVISION 18
SPORT TRACK	FORD	08-09	20	20	38-200	38-200			21-200	21-200			2020	2020		16-200	16-200		MEGAVISION 20
SPORT VAN	VOLKSWAGEN	06-08	22	13	22-1	38-180			21-220	21-180			2022	2015		16-220	16-180		MEGAVISION 22/18
SPRINT	CHEVROLET	86-88	16	16	14	38-160	38-160	38-140	21-160	21-160			2016	2016		16-160	16-160		MEGAVISION 16
SPRINTER	MB	03-06	22	22	30-221	30-221		SUV2222	21-220	21-220			2022	2022		16-220	16-220		MEGAVISION 22
SPRINTER	MB	07-09	24	24	30-240	30-240		SUV2424	21-240	21-240			2024	2024		16-240	16-240		MEGAVISION 24
SRX	CADILLAC	04-07	22	21	13	30-221			21-220				2022	2021	2013	16-220	16-210		MEGAVISION 22/20
STANZA	NISSAN	84-86	18	18	38-180	38-180			21-180	21-180			2018	2018		16-180	16-180		MEGAVISION 18
STANZA	NISSAN	87-90	19	18	38-190	38-190			21-190	21-190			2019	2019		16-190	16-190		MEGAVISION 19
STANZA	NISSAN	91-92	20	20	38-200	38-200			21-200	21-200			2020	2020		16-200	16-200		MEGAVISION 20
STEALTH	DODGE	91-97	21	20		38-200				21-200			2021	2020		16-210	16-200		
STRADA ADVENTURE	FIAT	07-08	21	19				30-219		21-190			2021	2019		16-210	16-190		MEGAVISION 19/21
STRATUS	DODGE	95-05	22	22	22-1	22-1			21-220	21-220			2022	2022		16-220	16-220		MEGAVISION 22
STYLUS	ISUZU	91-94	22	20	30-221	38-200			21-220	21-200			2022	2020		16-220	16-200		MEGAVISION 22/20
S-TYPE	JAGUAR	00-04	24	18	30-240	38-190			21-240	21-190			2024	2019		16-240	16-190		MEGAVISION 24/18
SUBURBAN	CHEVROLET	86-99	16	16	38-160	38-160			21-160	21-160			2016	2016		16-160	16-160		MEGAVISION 16
SUBURBAN	CHEVROLET	00-08	22	22	19	22-1	22-1	38-160	21-220	21-220	21-160		2022	2022	2016	16-220	16-220	16-160	MEGAVISION 22
SUMMIT	EAGLE	89-91	20	16	38-200	38-160			21-200	21-160			2020	2016		16-200	16-160		MEGAVISION 20/16
SUMMIT	EAGLE	92-95	21	18				30-219		21-190			2021	2019		16-210	16-190		MEGAVISION 19/21
SUNBRD	PONTIAC	85-89	16	16	38-160	38-160			21-160	21-160			2016	2016		16-160	16-160		MEGAVISION 16
SUNBRD	PONTIAC	90-94	18	18	38-180	38-180			21-180	21-180			2018	2018		16-180	16-180		MEGAVISION 18
SUNFIRE	PONTIAC	97-02	22	16	30-221	38-160			21-220	21-160			2022	2016		16-220	16-160		MEGAVISION 22/16
SWIFT	SUZUKI	89-96	20	18	38-200	38-180			21-200	21-180			2020	2018		16-200	16-180		MEGAVISION 20/18
SWIFT	SUZUKI	06-08	22	18	30-221	38-190			21-220	21-190			2022	2019		16-220	16-190		MEGAVISION 22/18
TACOMA	TOYOTA	06-08	22	21	30-221				21-220				2022	2021		16-220	16-210		MEGAVISION 22/20
TAHOE	CHEVROLET	00-06	22	22	14	22-1	22-1	38-140	21-220	21-220			2022	2022		16-220	16-220		MEGAVISION 22
TAURUS	FORD	86-91	19	18	38-190	38-190			21-190	21-190			2019	2019		16-190	16-190		MEGAVISION 19
TAURUS WAGON	FORD	88-94	20	20	14	38-200	38-200	38-140	21-200	21-200			2020	2020		16-200	16-200		MEGAVISION 20
TEMPEST	PONTIAC	90-94	19	18	38-190	38-190			21-190	21-190			2019	2019		16-190	16-190		MEGAVISION 19
TEMPO	FORD	89-94	19	18	38-190	38-190			21-190	21-190			2019	2019		16-190	16-190		MEGAVISION 19





# Master Automotriz 2010

## Productos Gates \* FORMAS Y DIMENSIONES



VEHICULO	MARCA	AÑO	PILOTO	COPILOTO	TRASERO	LONGITUD EN PULGADAS		E		E								
TIIDA	NISSAN	07-09	24	14		30-240	38-140	21-240	21-150	2024	2015	16-240	16-160					
TL	ACURA	06-08	28	18		28-9	38-180		21-180		2018	16-280	16-180					
TOLEDO	SEAT	01-06	21	19				30-219	21-190	2021	2019	16-210	16-190					
TOPAZ	MERCURY	89-94	19	19		38-190	38-190		21-190	21-190	2019	2019	16-190	16-190				
TORNADO	CHEVROLET	04-06	21	18				30-219	21-190	2021	2019	16-210	16-190					
TORRENT	PONTIAC	05-08	24	20	15		38-150	SUV2420	21-240	21-200	21-150	2024	2020	2015	16-240	16-200		
TOUAREG	VOLKSWAGEN	06-08	28	20		26-1	26-1								16-280	16-260		
TOWN & COUNTRY	CHRYSLER	93-95	22	18	18	30-221	38-180	38-180	21-220	21-180	21-180	2022	2018	2018	16-220	16-180	16-180	
TOWN & COUNTRY	CHRYSLER	96-07	28	28	16	28-9	28-9	38-160	SUV2825		21-160		2016		16-280	16-280	16-100	
TOWN GAR	LINCOLN	91-07	22	22		30-221	30-221		21-220	21-220		2022	2022		16-220	16-220		
TRACER	MERCURY	88-90	18	18		38-180	38-180		21-180	21-180		2018	2018		16-180	16-180		
TRACKER	GE0	90-97	18	18		38-180	38-180		21-180	21-180		2018	2018		16-180	16-180		
TRACKER	GE0	90-97	18	18	18	38-180	38-180	38-160	21-180	21-180	21-180	2018	2018	2018	16-180	16-180	16-160	
TRACKER	CHEVROLET	93-88	18	18	18	38-180	38-180	38-160	21-180	21-180	21-180	2018	2018	2018	16-180	16-180	16-160	
TRAILBLAZER	CHEVROLET	02-06	22	22	16	22-1	22-1	38-160	21-220	21-220	21-180	2022	2022	2016	16-220	16-220	16-160	
TRANS AM	CHEVROLET	94-98	24	24		30-240	30-240	SUV2424	21-240	21-240		2024	2024		16-240	16-240		
TRANS SPORT	PONTIAC	90-99	24	24	16			38-160	SUV2424	21-240	21-240	21-160	2024	2024	2016	16-240	16-240	16-160
TRANSIT	FORD	08-09	28	24		26-9	30-240			21-240			2024		16-280	16-240		
TREDIA	MITSUBISHI	83-88	16	10		38-160	38-160		21-160	21-160		2016	2016		16-160	16-160		
TRIBECA	SUBARU	06-08	20	20		26-1	38-200			21-200			2020		16-260	16-200		
TROOPER	ISUZU	92-98	20	20	15	38-200	38-200	38-150	21-200	21-200	21-150	2020	2020	2015	16-200	16-200		
TSUBAME	NISSAN	94-04	20	18	14	38-200	38-180	38-140	21-200	21-180		2020	2018		16-200	16-180		
TSURU	NISSAN	92-09	18	18		38-180	38-180		21-180	21-180		2018	2018		16-180	16-180		
TT ROADSTER	AUDI	99-07	21	18				30-219		21-190		2021	2019		16-210	16-190		
TUNDRA	TOYOTA	07-08	26	22		26-1	30-221			21-220			2022		16-260	16-220		
TYPHOON	GM	90-94	16	16	14	38-160	38-160	38-140	21-160	21-160		2016	2016		16-160	16-160		
UPLANGER	CHEVROLET	05-08	24	22	16	30-240	30-221	38-160	SUV2420	21-240	21-220	21-160	2024	2022	2016	16-240	16-220	16-160
URVAN	NISSAN	99-08	19	19		38-190	38-190		21-190	21-190		2019	2019		16-190	16-190		
V40	VOLVO	99-04	21	21	14			38-140					2021	2021		16-210	16-210	
V-40	VOLVO	02-07	21	20	16		38-200	38-160		21-200	21-160		2021	2020	2016	16-210	16-200	16-160
V70	VOLVO	99-04	21	21	14			38-140					2021	2021		16-210	16-210	
V-70	VOLVO	02-07	21	21	18			38-180			21-180		2021	2021	2016	16-210	16-210	16-160
VAN	VOLKSWAGEN	03-06	11	11		38-110	38-110		21-110	21-110		2011	2011					
VAN 1000	DOODGE	07-09	18	18		38-180	38-180		21-180	21-180		2018	2018		16-180	16-180		
VECTRA	CHEVROLET	03-07	24	18		30-240	38-190		21-240	21-190		2024	2019		16-240	16-190		
VENTURE	CHEVROLET	97-05	24	24	16			38-160	SUV2424	21-240	21-240	21-160	2024	2024	2016	16-240	16-240	16-160
VERNA	HYUNDAI	04-06	20	18		38-200	38-180		21-200	21-180		2020	2018		16-200	16-180		
VILLAGER	MERCURY	93-02	22	22	14	22-1	22-1	38-140	SUV2222	21-220	21-220		2022	2022		16-220	16-220	
VIPER	HYUNDAI	92-96	18	18		38-180	38-180		21-180	21-180		2018	2018		16-180	16-180		
VIPER SRT	DOODGE	03-05	16	16		38-160	38-160		21-160	21-160		2016	2016		16-160	16-160		
VOYAGER	PLYMOUTH & CHRYSLER	84-90	18	18	16	38-180	38-180		21-180	21-180		2018	2018		16-180	16-180		
VOYAGER	PLYMOUTH & CHRYSLER	91-95	22	18		30-221	38-180		21-220	21-180		2022	2018		16-220	16-180		
VOYAGER	PLYMOUTH & CHRYSLER	96-07	28	28	16	28-9	28-9	38-160	SUV2828		21-160		2016		16-280	16-280	16-160	
VW VAN	VOLKSWAGEN	02-06	20	18		38-200	38-180		21-200	21-180		2020	2018		16-200	16-180		
WAGONEER	VAM	84-96	18	18		38-180	38-180		21-180	21-180		2018	2018		16-180	16-180		
WAGONEER	JEEP	86-91	18	18	12	38-180	38-180	38-120	21-180	21-180		2018	2018		16-180	16-180		
WINDSTAR	FORD	94-03	24	20	16	30-240	38-200	38-160	SUV2420	21-240	21-200	21-160	2024	2020	2016	16-240	16-200	16-160
WRANGLER	JEEP	87-95	12	12	16	38-120	38-120	38-160		21-160			2016				16-160	

## Master Automotriz 2010

### Productos Gates \* FORMAS Y DIMENSIONES

VEHICULO	MARCA	AÑO	PILOTO	COPILOTO	TRASERO	LONGITUD EN MM GATES											
WRANGLER	JEEP	96-04	16	18	13	38-180	38-180		21-180	21-180	21-130	2018	2018	2013	16-180	16-180	MEGAVISION 18
X3	BMW	04-08	22	20		30-221	38-200		21-220	21-200		2022	2020		16-220	16-200	MEGAVISION 22/20
X5	BMW	00-04	24	22		30-240	38-220		21-240	21-220		2024	2022		16-240	16-220	MEGAVISION 24/22
XC70	VOLVO	99-04	21	21								2021	2021		16-210	16-210	
XC90	VOLVO	05-07	24	22		30-240	38-220		21-240	21-220		2024	2022		16-240	16-220	MEGAVISION 24/22
XJ8	JAGUAR	88-02	21	21								2021	2021		16-210	16-210	
XJR	JAGUAR	99-02	21	21								2021	2021		16-210	16-210	
XX8	JAGUAR	98-04	23	21								2021	2021		16-210	16-210	
XL7	SUZUKI	07-08	24	18		30-240	38-190		21-240	21-190		2024	2019		16-240	16-190	MEGAVISION 24/18
X-TERRA	NISSAN	00-04	19	19	14	38-198	38-190	38-140	21-190	21-190		2019	2019		16-190	16-190	MEGAVISION 19
X-TERRA	NISSAN	05-08	24	18		30-240	38-180		21-240	21-180		2024	2018		16-240	16-180	MEGAVISION 24/18
X-TRAIL	NISSAN	03-07	24	18	18	30-240	38-150	38-160	21-240	21-150	21-160	2024	2015	2018	16-240	16-160	
X-TYPE	JAGUAR	02-04	21	18					30-218	21-190		2021	2019		16-210	16-190	MEGAVISION 19/21
YARIS	TOYOTA	04-06	20	13	13	38-200			21-200	21-130	21-130	2020	2013	2013	16-200		
YARIS	TOYOTA	06-08	26	15		26-1	38-150			21-150		2015			16-260	16-160	
YUKON	GMC	92-00	18	18	14	38-180	38-180	38-140	21-180	21-180		2018	2018		16-180	16-180	MEGAVISION 18
YUKON	GMC	06-08	22	22		22-1	22-1	SUV2222	21-220	21-220		2022	2022		16-220	16-220	MEGAVISION 22
Z3	BMW	96-02	20	20		38-200	38-200		21-200	21-200		2020	2020		16-200	16-200	MEGAVISION 20
Z4	BMW	03-05	20	20		38-200	38-200		21-200	21-200		2020	2020		16-200	16-200	MEGAVISION 20
Z8	BMW	00-02	20	20		38-200	38-200		21-200	21-200		2020	2020		16-200	16-200	MEGAVISION 20
ZAFIRA	CHEVROLET	02-07	24	24		30-240	30-240	SUV2424	21-240	21-240		2024	2024		16-240	16-240	MEGAVISION 24
ZEPHIR	LINCOLN	06-08	24	18		30-240	38-190		21-240	21-190		2024	2019		16-240	16-190	MEGAVISION 24/18
ZR	MG	03-05	18	18		38-180	38-180		21-180	21-180		2018	2018		16-180	16-180	MEGAVISION 18
ZT 180	MG	03-05	22	22		22-1	22-1	SUV2222	21-220	21-220		2022	2022		16-220	16-220	MEGAVISION 22



¡ Nuestra Visión es tu Seguridad !

**Dimensiones & Empaque**

- ✓ Recubrimiento de Teflón
- ✓ Presión continua por su construcción aerodinámica tipo flat

## NEOFORM

Descripción	Longitud en Pulgadas	Longitud en milímetros	Empaque
16-160	16	406	Sencillo
16-170	17	432	Sencillo
16-180	18	457	Sencillo
16-190	19	483	Sencillo
16-200	20	508	Sencillo
16-210	21	533	Sencillo
16-220	22	559	Sencillo
16-240	24	610	Sencillo
16-260	26	660	Sencillo
16-280	28	712	Sencillo



¡ Nuestra Visión es tu Seguridad !

**Dimensiones & Empaque**

- ✓ Empaque doble
- ✓ Estructura más resistente
- ✓ Reforzado con remaches de acero inoxidable
- ✓ Mayor visibilidad
- ✓ Mayor porcentaje de hule natural

**¡Al mejor precio!**

## MegaVision

Descripción	Longitud en Pulgadas	Longitud en milímetros	Empaque
MEGAVISION WB 405 11"	11	279	Doble
MEGAVISION WB 405 13"	13	330	Doble
MEGAVISION WB 405 15"	15	381	Doble
MEGAVISION WB 405 16"	16	406	Doble
MEGAVISION WB 405 18"	18	457	Doble
MEGAVISION WB 405 19"	19	483	Doble
MEGAVISION WB 405 19 & 21"	21/19	533/483	Doble
MEGAVISION WB 405 20"	20	508	Doble
MEGAVISION WB 405 22"	22	559	Doble
MEGAVISION WB 405 24"	24	610	Doble
MEGAVISION WB 405 20&18"	20/18	508/406	Doble
MEGAVISION WB 405 20"&18"	20/18	508/457	Doble
MEGAVISION WB 405 22"&18"	22/18	559/406	Doble
MEGAVISION WB 405 22"&18"	22/18	559/457	Doble
MEGAVISION WB 405 22"&20"	22/20	559/508	Doble
MEGAVISION WB 405 24"&18"	24/18	610/457	Doble
MEGAVISION WB 405 24"&20"	24/20	610/508	Doble
MEGAVISION WB 405 24"&22"	24/22	610/559	Doble



## ¡ Nuestra Visión es tu Seguridad !

A Tenneco Company

**Dimensiones & Empaque**

- ✓ Estructura de acero tubular  
• Durabilidad y confianza
- ✓ Hule natural  
• Fórmula patentada
- ✓ Reemplazo exacto de EO  
• Adaptador universal

¡ Limpian sin rayar !

Descripción	Longitud en Pulgadas	Longitud en milímetros	Empaque
38-110	11	279	Sencillo
38-120	12	305	Sencillo
21-130	13	330	Sencillo
38-140	14	345	Sencillo
38-150	15	381	Sencillo
38-160	16	406	Sencillo
38-180	18	457	Sencillo
38-190	19	483	Sencillo
30-219	21/19	533/483	Doble
38-200	20	508	Sencillo
38-201 c/perno	20	508	Sencillo
38-220 c/perno	22	559	Sencillo
22-1	22	559	Sencillo
30-221	22	559	Sencillo
30-240	24	610	Sencillo
26-1	26	660	Sencillo
28-9	28	712	Sencillo

## ¡ Nuestra Visión es tu Seguridad !

A Tenneco Company

**Dimensiones & Empaque**

- ✓ Estructura de plástico de ALTO IMPACTO  
• Durabilidad y resistencia
- ✓ Hule natural  
• Fórmula patentada que lubrica y protege del desgaste

Descripción	Longitud en Pulgadas	Longitud en milímetros	Empaque
2011	11	279	Sencillo
2013	13	330	Sencillo
2015	15	381	Sencillo
2016	16	406	Sencillo
2017	17	432	Sencillo
2018	18	457	Sencillo
2019	19	483	Sencillo
2020	20	508	Sencillo
2022	22	559	Sencillo
2024	24	610	Sencillo



**Gates**  
A Tenneco Company

**¡ Nuestra Visión es tu Seguridad !**

**Dimensiones & Empaque**

- ✓ Estructura de plástico de ALTO IMPACTO
- Durabilidad y resistencia
- ✓ Hule natural
- No se parte
- No se agrieta



**NU-VISION**

Descripción	Longitud en Pulgadas	Longitud en milímetros	Empaque
21-110	11	279	Sencillo
21-130	13	330	Sencillo
21-150	15	381	Sencillo
21-160	16	406	Sencillo
21-180	18	457	Sencillo
21-190	19	483	Sencillo
21-200	20	508	Sencillo
21-220	22	559	Sencillo
21-240	24	610	Sencillo

**Gates**  
A Tenneco Company

**¡ Nuestra Visión es tu Seguridad !**

**Dimensiones & Empaque**

- ✓ Estructura metálica
- ✓ Visibilidad total
- ✓ Amplia cobertura
- Mini Vans
- SUV
- Crossover



**TRICO**

Descripción TRICO metálico SUV & Mini Vans	Longitud en Pulgadas	Longitud en milímetros	Empaque
SUV2020	20/20	508/508	Doble
SUV2222	22/22	559/559	Doble
SUV2420	24/20	610/508	Doble
SUV2424	24/24	610/610	Doble
SUV2828	28/28	712/712	Doble

**¡ Nuestra Visión es tu Seguridad !**

A Tomkins Company

**Dimensiones & Empaque**

- ✓ Estructura de acero
- ✓ Hule natural
  - No se parte
  - No se rompe
  - No se deshace

*¡ Limpian sin rayar !*

Descripción TRICO metalico Servicio Pesado Serie 61 Plano	Longitud en Pulgadas	Longitud en milímetros	Empaque
61-100	10	254	Sencillo
61-110	11	279	Sencillo
61-120	12	305	Sencillo
61-130	13	330	Sencillo
61-131	13	330	Sencillo
61-140	14	345	Sencillo
61-150	15	381	Sencillo
61-151	15	381	Sencillo
61-160	16	406	Sencillo
61-161	16	406	Sencillo
61-170	17	432	Sencillo
61-180	18	457	Sencillo
61-181	18	457	Sencillo
61-190	19	483	Sencillo
61-200	20	508	Sencillo
61-201	20	508	Sencillo
61-210	21	533	Sencillo
61-220	22	559	Sencillo

**¡ Nuestra Visión es tu Seguridad !**

A Tomkins Company

**Dimensiones & Empaque**

- ✓ Estructura de alta resistencia
- ✓ Hule natural
  - No se parte
  - No se rompe
  - No se deshace

*¡ Limpian sin rayar !*

Descripción TRICO metalico Servicio PESado Serie 63 Curvo	Longitud en Pulgadas	Longitud en milímetros	Empaque
63-120	12	305	Sencillo
63-140	14	345	Sencillo
63-141	14	345	Sencillo
63-151	15	381	Sencillo
63-160	16	406	Sencillo
63-180	18	457	Sencillo
63-181	18	457	Sencillo
63-200	20	508	Sencillo
63-201	20	508	Sencillo



## Master Automotriz 2010 Productos Gates \* FORMAS Y DIMENSIONES

### Limpiaparabrisas Trico

Para limpiar y retirar líquidos que obstruyan la visibilidad.  
Los hay con estructura metálica o de plástico, pero todos con la misma formulación de hule natural con cera que cuida y protege el parabrisas

Longitud	No. Parte	TIPO GANCHO				ADAPTADOR			
10"	38-110	5mm	6,8mm						
12"	38-120				3/16"				
13"	38-130	7mm	7,9mm						
14"	38-140	7mm	7,9mm	3/16"					
15"	38-150	7mm	7,9mm						
16"	38-160	7mm	7,9mm	3/16"					
18"	38-180	7mm	7,9mm	3/16"					
19"	38-190	7mm	7,9mm	3/16"					
19"	38-191			3/16"					
20"	38-200		7,9mm	3/16"					
20"	38-201			1/4"					
22"	38-220			1/4"					
22"	30-221		9mm	1/4"					
22"	22-9		9X4						
24"	30-240		9mm	1/4"					
28"	28-9		9X4						

### NUVISION – (Plástico de Alto Impacto)

### ROBERK – (Plástico de Alto Impacto)

Longitud	No. Parte	TIPO GANCHO				ADAPTADOR			
10"	21-110	5mm	6,8mm	3/16"					
13"	21-130	7mm	7,9mm	3/16"					
15"	21-150	7mm	7,9mm						
16"	21-160	7mm	7,9mm	3/16"					
17"	21-170	7mm	7,9mm	3/16"					
18"	21-180	7mm	7,9mm	3/16"					
19"	21-190	7mm	7,9mm	3/16"					
20"	21-200		7,9mm, 9X4	3/16", 1/4"					
22"	21-220		7,9mm, 9X4	3/16", 1/4"					
24"	21-240		7,9mm, 9X4	3/16", 1/4"					

Longitud	No. Parte	TIPO GANCHO				ADAPTADOR			
10"	2011	5mm	6,8mm	3/16"					
13"	2013	7mm	7,9mm	3/16"					
15"	2015	7mm	7,9mm						
16"	2016	7mm	7,9mm	3/16"					
17"	2017	7mm	7,9mm	3/16"					
18"	2018	7mm	7,9mm	3/16"					
19"	2019	7mm	7,9mm	3/16"					
20"	2020		7,9mm, 9X4	3/16", 1/4"					
22"	2022		7,9mm, 9X4	3/16", 1/4"					
24"	2024		7,9mm, 9X4	3/16", 1/4"					



## Master Automotriz 2010 Productos Gates \* FORMAS Y DIMENSIONES



### H - Abrazaderas Gates

Acero Inoxidable Series 201 y 301

**Recomendada para usarse en:** Aplicaciones en general, usos automotrices e industriales.

**Construcción:**

**Tornillo:** Acero al carbón con recubrimiento de 0.0002" de zinc y adicionalmente con una capa de dicromato color transparente, cabeza hexagonal de 5/16".

**Caja:** Acero inoxidable serie 201 y 301, de una sola pieza, fijada a la banda con 4 puntos de soldadura.

**Banda:** Acero inoxidable serie 201 y 301, con ranuras paralelas redondeadas, de 1/2" de ancho.

**Norma SAE:** J1508

**Presentación:** Ver empaques en la tabla anexa.

N° Parte	Empaque	RANGO DIAM. INT. (PULG.)			
		GATES	Pzas.	MIN.	MAX.
MM4 (Micro)	200			1/4	5/8
MM5 (Micro)	100			5/16	29/32
H8	50			7/16	29/32
H10	50			9/16	1-1/16
H12	25			11/16	1-1/4
H16	25			3/4	1-1/2
H20	50			13/16	1-3/4
H24	50			1-1/16	2
H28	50			1-5/16	2-1/4
H32	25			1-9/16	2-1/2
H36	25			1-13/16	2-3/4
H40	25			2-1/16	3
H44	25			2-5/16	3-1/4
H48	25			2-9/16	3-1/2
H52	25			2-13/16	3-3/4
H60	20			3-5/16	4-1/4
H72	20			4-1/6	5
H88	Granel			5-1/16	6
H96	Granel			5-9/16	6-1/2
H104	Granel			6-1/16	7



### HP - Abrazaderas Gates

Acero Inoxidable Series 201 y 301

**Recomendada para usarse en:** Aplicaciones en general, usos automotrices e industriales.

**Construcción:**

**Tornillo:** Acero al carbón con recubrimiento de 0.0002" de zinc y adicionalmente con una capa de transparente de dicromato claro, cabeza hexagonal de 5/16".

**Caja:** Acero al carbón con recubrimiento de 0.0002" de zinc y adicionalmente con una capa de transparente de dicromato claro.

**Banda:** Acero inoxidable serie 201 y 301, con ranuras paralelas redondeadas, de 1/2" de ancho.

**Norma SAE:** J1508

**Presentación:** Ver empaques en la tabla anexa.

N° Parte	Empaque	RANGO DIAM. INT. (PULG.)			
		GATES	Pzas.	MIN.	MAX.
MP3 (Micro)	200			1/4	1/2
MP4 (Micro)	200			1/4	5/8
MP5 (Micro)	100			5/16	29/32
HP6	75			7/16	25/32
HP8	50			7/16	29/32
HP10	50			9/16	1-1/16
HP12	25			11/16	1-1/4
HP16	25			3/4	1-1/2
HP20	50			13/16	1-3/4
HP24	50			1-1/16	2
HP28	50			1-5/16	2-1/4
HP32	25			1-9/16	2-1/2
HP36	25			1-13/16	2-3/4





## Master Automotriz 2010 Productos Gates \* FORMAS Y DIMENSIONES



### TBLS - Abrazaderas Gates

Acero Inoxidable Serie 301

**Recomendada para usarse en:**

Mangueras de silicón de turbocargador, líneas de entradas de aire, mangueras de agua, bolsas de filtros, mangueras de bombas de agua, mangueras de sistemas de irrigación, etc.

**Construcción:**

**Tornillo:** Acero al carbón zincado

**Tuerca:** Acero al carbón zincado.

**Resorte:** Acero al carbón zincado

**Banda:** Acero inoxidable serie 301, de 3/4" de ancho.

**Presentación:** A granel.



### TB - Abrazaderas Gates

Acero Inoxidable Serie 301

**Recomendada para usarse en:**

Mangueras de silicón de turbocargador, líneas de entradas de aire, mangueras de agua, bolsas de filtros, mangueras de bombas de agua, mangueras de sistemas de irrigación, etc.

**Construcción:**

**Tornillo:** Acero al carbón zincado

**Tuerca:** Acero al carbón zincado.

**Banda:** Acero inoxidable serie 301, de 3/4" de ancho.

**Presentación:** A granel.

NO. PARTE GATES	DIAMETRO (IN)		
	NOM.	MIN.	MAX.
TBLS212	1.94	1.82	2.12
TBLS236	2.25	2.06	2.36
TBLS255	2.44	2.25	2.55
TBLS286	2.75	2.56	2.86
TBLS308	3	2.78	3.08
TBLS333	3.25	3.03	3.33
TBLS352	3.44	3.22	3.52
TBLS383	3.75	3.53	3.83
TBLS408	4	3.78	4.08
TBLS433	4.25	4.03	4.33
TBLS436	4.28	4.06	4.36
TBLS458	4.5	4.28	4.58
TBLS483	4.75	4.53	4.83
TBLS508	5	4.78	5.08
TBLS533	5.25	5.03	5.33
TBLS558	5.5	5.28	5.58
TBLS570	5.62	5.4	5.7
TBLS608	6	5.78	6.08
TBLS633	6.25	6.03	6.33
TBLS655	6.47	6.25	6.55
TBLS668	6.6	6.38	6.68
TBLS708	7	6.78	7.08
TBLS758	7.5	7.28	7.58
TBLS780	7.72	7.5	7.8
TBLS783	7.75	7.53	7.83
TBLS858	7.5	8.28	8.58

NO. PARTE GATES	DIAMETRO (IN)		
	NOM.	MIN.	MAX.
TB 206	1.97	1.88	2.06
TB 221	2.14	2.06	2.21
TB 259	2.45	2.31	2.59
TB 265	2.52	2.38	2.65
TB 284	2.7	2.56	2.84
TB 309	2.95	2.81	3.09
TB 321	3.08	2.94	3.21
TB 359	3.45	3.31	3.59
TB 387	3.72	3.56	3.87
TB 409	3.95	3.81	4.09
TB 434	4.2	4.06	4.34
TB 459	4.45	4.31	4.59
TB 487	4.72	4.56	4.87
TB 509	4.95	4.81	5.09
TB 537	5.22	5.06	5.37
TB 562	5.47	5.31	5.62
TB 587	5.72	5.56	5.87
TB 609	5.95	5.81	6.09
TB 637	6.22	6.06	6.37
TB 659	6.45	6.31	6.59
TB 709	6.95	6.81	7.09
TB 737	7.22	7.06	7.37
TB 762	7.48	7.34	7.62
TB 787	7.72	7.56	7.87
TB 812	7.97	7.81	8.12

**Master Automotriz 2010**  
**Productos Gates \* FORMAS Y DIMENSIONES**

**Destelladores (Flashers) - TRIDON**



Se utilizan para el control de las luces exteriores y direccionales, funcionan mediante un sistema electro-mecánico.

**Destelladores Electromecánicos**

Destelladores de rendimiento y desempeño mejorado, hechos para trabajar con precisión y confiabilidad en aplicaciones que requieren cargas más altas que las normales y diseño robusto, incluso para aplicación industrial.

N°	Aplicación	Terminales	Vida	Carga de Focos	Poder
EL12	Industrial, Camiones - Alta carga de Focos	Dos (X,L)	200 Hrs	1 a 10 Focos	240 W
EL13	Industrial, Camiones - Alta carga de Focos	Tres (X,L,P)	200 Hrs	1 a 10 Focos	240 W
EG22	Todas las aplicaciones de Destelladores de 24 Volts	Dos (X,L)	100 Hrs	1 a 10 Focos	240 W
EG23	Todas las aplicaciones de Destelladores de 24 Volts	Tres (X,L,P)	100 Hrs	1 a 10 Focos	240 W
HD12	Todas las aplicaciones de Destelladores de 12 Volts	Dos (X,L)	200 Hrs	1 a 10 Focos	240 W
HD13	Todas las aplicaciones de Destelladores de 12 Volts	Tres (X,L,P)	200 Hrs	1 a 10 Focos	240 W



## Master Automotriz 2010 Productos Gates \* FORMAS Y DIMENSIONES

### Destelladores Electrónicos

Destelladores para muy alta carga de focos y larga vida, fabricados con circuitos electrónicos y la mayor confiabilidad, para las aplicaciones más demandantes. La detección de falla de foco está interconstruida en la mayoría de los Destelladores TRIDON y el diseño para Servicio SUPER Pesado se basa a las condiciones más rigurosas de trabajo.

## Aplicaciones primarias Flashers Electrónicos TRIDON ▶

EP27			
Caract. 3 Terminales (12v / 162 W)			
1996-2005	Chevrolet/Cadillac	Chevrolet/Suzuki	2.202 A.L.H.
1986-2004	Dodge	Ram Pickup	5.52 Diesel/3.75 Lit. 35, 25, 95 & 1 Lit.
2005-2008	Ford/Mercury	Ford F150/Excursion	3.0 Lit.
1995-2007	Ford	Range	2.3, 2.5, 3.0 Lit.
1995-2008	Ford	Woodchuck/Explorer	3.0, 3.5, 4.0 Lit.
1997-2007	Ford	F-Series Super Duty	4.2, 4.5, 4.8 Lit.
2002-2007	Ford	F-550 Super Duty	6.0 Diesel/7.3 Diesel/8 Lit.
1997-2005	Jeano	T-2/Cherokee/Grand Cherokee	2.4, 2.5, 3 Lit.

EP28			
Caract. 3 Terminales (12v / 160 W)			
1987-2008	Chrysler/Plymouth	Voyager/Minivan/Tram Sport	3.5 Lit.
1986-2005	Chevrolet/GMC	Astra/Corvette/Vectra	4.3 Lit.
2001-2003	Chevrolet/GMC	Express/Suburban	6.5 Lit.
1997-2004	Chrysler	Caravan	3.4 Lit.
1987-2003	Plymouth	Dodge/Impala/Stratus	3.1, 3.5, 4 Lit.
1995-2004	Suzuki	Compass Pickup	1.8 Lit.

EP29			
Caract. 4 Terminales (12v / 162 W)			
1998-2004	Chevrolet/GMC	Akura/Truck	4.3 Lit.
1999-2004	Chevrolet	Suburban/Truck	4.3, 4.5, 5.3 Lit.
1998-2003	Chevrolet	Corvette Vectra	4.0 Lit.
1999-2002	GMC	Pickup Truck	4.3, 4.5, 5.3 Lit.
1998-2002	GMC	Savana	4.3, 5.0 Lit.
2000-2002	Chevrolet/GMC	Suburban/Truck	5.3, 6.0 Lit.
1998-2002	Dodge/Jeep	Truck	4.3 Lit.

EP34			
Caract. 3 Terminales (12v / 162 W)			
1988-2004	Chevrolet	Tracker	1.6, 2.0, 2.3 Lit.
1995-1998	Ford/Mercury	Excursion/Bravo	2.0, 2.3 Lit.
1995-2008	Ford/Mercury	Thunderbird	3.0 Lit.
2007-2008	Ford	Excursion Van	4.5, 5.4 Lit.
1993-1998	Ford	Excursion	3.0, 4.0 Lit.
1990-2000	Honda	Civic	1.6 Lit.
1990-2002	Honda	Accord	2.3, 2.5 Lit.
1988-2007	Honda	Odyssey/Pass	3.5 Lit.
1992-2008	Honda	Ventura/Minivan	1.6, 1.8 Lit.
1992-2002	Mercury	Voyager	3.0, 3.5 Lit.
1990-2008	Nissan	Titan	1.6 Lit.
2000-2007	Nissan	Frontier	1.6, 2.5 Lit.
2000-2001	Nissan	Frontier/Pathfinder/Truck	2.4 Lit.
1989-2004	Nissan	Frontier/Excursion/Truck	3.3 Lit.
1988-2008	Suzuki	Truck	2.5 Lit.
1989-2000	Suzuki	Grand Vitara	2.5, 2.7 Lit.

EP35			
Caract. 3 Terminales (12v / 162 W)			
1997-2002	Audi	A4	1.8 Lit.
1995-2001	Audi	A4/A8	2.8 Lit.
1995-2001	Ford/Mercury	Corona/Markus	2.0, 2.3 Lit.
1992-2000	Isuzu	Compass/Crosby	1.8 Lit.
1992-2002	Isuzu	Compass	3.2 Lit.
1995-2004	Toyota	Tacoma	2.4, 2.7, 4.1 Lit.
2000-2008	Volkswagen	Golf/Jetta	1.8 Lit.
1990-2008	Volkswagen	Golf/Jetta	2.0 Lit.
1990-2008	Volkswagen	Golf/Jetta Diesel	1.8 Lit.
1995-1997	Volkswagen	Golf/Jetta/Passat VR6	2.8 Lit.
2000-2003	Volkswagen	SARATOGA	1.8 Lit.

EP36			
Caract. 3 Terminales (12v / 162 W)			
1993-1998	Dodge	Caravan/Grand Caravan	3.0, 3.5, 6 Lit.
1992-1998	Dodge/Chrysler	Voyager/Grand Voyager	3.0, 3.3, 4 Lit.
1998-2008	Chrysler	Chrysler PT	1.8 Lit.
2000-2008	Chrysler	Kia/Star	Camelion 1.2, 1.6, 1.8 Lit.

LL552			
Caract. 2 Terminales (12v / 160 W)			
1992-2000	Jeep	Dodge/Compass/Stratus	1.8 Lit.
1990-1996	Chrysler	Lumina	3.1 Lit.
1990-1999	Chrysler	Motor/Minivan/Grand S/Pickup	4.3 Lit.
1990-1999	Chrysler	Shadow/Dodge	2.5, 2.8 Lit.
1994-1994	Ford/Mercury	Tempo/Truck	2.5, 3.0 Lit.
1993-1997	Ford	Ranger	2.3, 3.0 Lit.
1991-1997	GMC/Chrysler	Compass/3.0	2.3, 2.5 Lit.
1990-1999	GMC	Suburban/Truck	4.3 Lit.
1990-1997	Jeep	Cherokee/Truck	2.5, 2.8 Lit.
1990-1997	Jeep	Compass/Stratus	3.1 Lit.
1995-1998	Plymouth	Tram Sport	3.1, 4.0, 6 Lit.



- Mayor capacidad en watts
- Mayor tiempo de vida
- Excede normas de EO
- Largos periodos de trabajo continuo

**¡¡NO ARRIESGUES TU SEGURIDAD CON PRODUCTOS BARATOS!!**



## Master Automotriz 2010 Productos Gates \* FORMAS Y DIMENSIONES

### Temperaturas alternas disponibles para termostatos de Servicio Ligero y SUPERSTAT®

Gates sugiere usar el termostato descrito por el fabricante del automóvil con los grados de temperatura correctos, la sustitución puede causar un mal desempeño del termostato.

No. Parte	195°	180°	170°	160°
33006	33009	33008	---	33006
33008	33009	33008	---	33006
33009	33009	33008	---	33006
33019	33019	---	---	---
33026	---	33028	---	33026
33028	---	33028	---	33026
33029	33029	---	---	---
33036	33039	33038	---	33036
33038	33039	33038	---	33038
33039	33039	33038	---	33036
33046	---	33308	---	33046
33048	33049	33048	---	---
33049	33049	33048	---	---
33056	33209	33208	---	33056
33058	33059	33058	---	---
33059	33059	33058	---	---
33068	---	33068	---	---
33069	33069	---	---	---
33078	33079	33078	---	---
33079	33079	33078	---	---
33088	---	33088	---	---
33108	33109	33108	---	---
33109	33109	33108	---	---
33118	33179	3311	--	--
33128	33129	33128	---	---
33129	33129	33128	---	---
33146	---	33148	33147	33146
33147	---	33148	33147	33146
33148	---	33148	33147	33146
33156	---	33158	---	33156
33158	---	33158	---	33156
33166	---	33168	33167	33166
33167	---	33168	33167	33166
33168	---	33168	33167	33166
33176	---	33178	---	33176
33178	---	33178	---	33176
33179(1)	33179(1)	33118	---	---
33180	33180	---	---	---
33188	33189	33188	---	---
33189	33189	33188	---	---
33196	33199	33198	---	33196
33198	33199	33198	---	33196
33199	33199	33198	---	33196
33208	33209	33208	---	33056
33209	33209	33208	---	33056
33218	---	33218	---	---
33238	33248	33238	---	---
33248	33248	33238	---	---
33249	33249	---	---	---
33258	33259	33258	---	---
33259	33259	33258	---	---
33268	33269	33268	---	---
33269	33269	33268	---	---
33279	33279	33278	---	---
33299	33299	---	---	---
33306	---	---	---	33306
33308	---	33308	---	33046

No. Parte	195°	180°	170°	160°
33329	33329	---	---	---
33338	33339	33338	---	---
33339	33339	33338	---	---
33348	---	33348	---	---
33386	---	33388	33387	33386
33387	---	33388	33387	33386
33388	---	33388	33387	33386
33398	---	33398	---	---
33419	33419	---	---	---
33428	33429	33428	---	---
33429	33429	33428	---	---
33438	33439	33438	---	---
33439	33439	33438	---	---
33447	---	33448	33447	---
33448	---	33448	33447	---
33468	33469	33468	---	---
33469	33469	33468	---	---
33478	33479	33478	---	---
33479	33479	33478	---	---
33488	33489	33488	---	---
33489	33489	33488	---	---
33498	---	33498	---	---
33508	33509	33508	---	---
33509	33509	33508	---	---
33518	---	33518	---	---
33528	33528	---	---	---
33529	33529	---	---	---
33548	---	33548	---	---
33556	---	---	---	33556
33557	---	33558	33557	---
33558	---	33558	33557	---
33568	33569	33568	---	---
33569	33569	33568	---	---
33576	33579(1)	3357	3357	3357
33577	33579(1)	3357	3357	3357
33578	33579(1)	3357	3357	3357
33579	33579(1)	3357	3357	3357
33587	33589(1)	3358	3358	--
33588	33589(1)	3358	3358	--
33589	33589(1)	3358	3358	--
33599	33599	---	---	---
33708	---	33708	---	---
33718	33719	33718	---	---
33719	33719	33718	---	---
33728	---	33728	---	---
33737	---	33738	33737	---
33738	---	33738	33737	---
33747	---	33748	33747	---
33748	---	33748	33747	---
33758	---	33758	---	---
33768	---	33768	---	---
33778	33779	33778	---	---
33779	33779	33778	---	---
33788	---	33788	---	---
33798	---	33798	---	---
33808	---	33808	---	---
33817	---	---	33817	---

No. Parte	195°	180°	170°	160°
33828	---	33828	---	---
33838	---	33838	---	---
33849	33849	---	---	---
33857	---	---	33857	---
33867	---	33868	33867	---
33868	---	33868	33867	---
33877	---	33878	33877	---
33878	---	33878	33877	---
33888	---	33888	---	---
33889	33889	---	---	---
33907	---	33908	33907	---
33908	---	33908	33907	---
33909	33909	---	---	---
33910	---	33910(2)	--	--
33911	33911	---	---	---
33912	---	33912	---	---
33913	---	---	33913	---
33914	---	---	33914	---
33915	33915(1)	--	--	--
33917	33917(1)	--	--	--
33918	---	33918	---	---
33919	33919	---	---	---
33920	---	33920	---	---
33921	33921(1)	--	--	--
33922	33922(1)	--	--	--
33923	33923(1)	--	--	--
33924	33924(1)	--	--	--
33930	33930(3)	--	--	--
33931	---	33931(4)	--	--
33932	33932(3)	--	--	--
33933	---	33933(4)	--	--
33934	33934(5)	--	--	--
33935	33935(6)	--	--	--
33936	33936(7)	--	--	--
33937	33937(8)	--	--	--
33938	---	33938	---	---
33939	33939(1)	--	--	--
33940	---	---	33940	---
33941	---	33941	---	---
33942	---	---	33942	---
33943	---	33943	---	---
33944	---	---	33944	---
33945	33945(1)	--	--	--
33946	---	33946	---	---
33947	---	33947	---	---
33948	---	33948(9)	--	--
33949	---	---	33949(10)	--
33950	---	33950	---	---
33951	---	33951	---	---
33952	33952	---	---	---
33953	---	33953	---	---
33954	---	33954	---	---
33955	---	33955	---	---



## Master Automotriz 2010 Productos Gates \* FORMAS Y DIMENSIONES

No. Parte	195°	180°	160°
33006 S	33009 S	33008 S	33006 S
33008 S	33009 S	33008 S	33006 S
33009 S	33009 S	33008 S	33006 S
33019 S	33019 S	----	--
33036 S	33039 S	33038 S	33036 S
33038 S	33039 S	33038 S	33036 S
33039 S	33039 S	33038 S	33036 S
33188 S	33189 S	33188 S	---
33189 S	33189 S	33189 S	---

No. Parte	195°	180°	160°
33198 S	33199 S	33198 S	---
33199 S	33199 S	33198 S	---
33208 S	33209 S	33208 S	---
33209 S	33209 S	33208 S	---
33258 S	33259 S	33258 S	---
33259 S	33259 S	33258 S	---
33329 S	33329 S	----	--
33419 S	33419 S	----	--
33428 S	33429 S	33428 S	---

No. Parte	195°	180°	160°
33429 S	33429 S	33428 S	---
33478 S	33479 S	33478 S	---
33479 S	33479 S	33478 S	---
33488 S	33489 S	33488 S	---
33489 S	33489 S	33488 S	---
33568 S	33569 S	33568 S	---
33569 S	33569 S	33568 S	---
33708 S	---	33708 S	--

Tapones de Radiador Rangos de presión	
4	3-5
7	6-8
10	9-11
13	12-16
14	12-16
15	14-18
16	14-18
18	16-20
20	18-22

- (1) 190°F Opening Temperature.
- (2) 186°F Opening Temperature.
- (3) 188°F Opening Temperature.
- (4) 176°F Opening Temperature.
- (5) 206°F Opening Temperature.
- (6) 221°F Opening Temperature.
- (7) 198°F Opening Temperature.
- (8) 203°F Opening Temperature.
- (9) 183°F Opening Temperature.
- (10) 172°F Opening Temperature.





**Master Automotriz 2010**  
**Productos Gates \* FORMAS Y DIMENSIONES**  
**TABLA DE INTERCAMBIO DE TERMOSTATOS**

STANT	GATES	MOTORAD	13959	33779	333-198	14008	33448	8210080	13429	33249	212-195
13006	33006	1160	13869	33489	335-192	13446	33386	8220060	13757	N/R	214-170
13008	33508	1180	14128	33878	336-180	13447	33387	8220070	13758	33708	214-180
13359	33009	1195	13849	33429	337-192	13448	33388	8220080	13759	N/R	214-192
13009	33509	1195	14089	33029	338-195	14457	33347	8300070	13978	33338	215-180
13076	33036	2160	14228	33808	339-180	14458	33348	8300080	13979	33339	215-192
13078	33038	2180	13788	33268	340-180	13938	33398	8400080	13918	33718	216-180
13079	33039	2195	13789	33269	340-195	14017	34033	8500070	13919	33719	216-190
13926	33026	2260	14138	33238	354-180	14018	34034	8500080	13926	33026	218-160
13928	33028	2270	14139	33248	354-192	14406	33166	8700060	13928	33028	218-180
13688	33158	2380	13348	33138	EX4482	14407	33167	8700070	13716	33176	219-160
13696	33146	2460	13349	33259	EX4488	14408	33168	8700080	13718	33178	219-180
13697	33147	2470	13368	33018	EX5282	14507	33577	8800070	13688	33158	220-180
13698	33148	2480	13369	33199	EX5288	14508	33578	8800080	13696	33146	221-160
13798	33498	2680	13369	33199	EX5295	13348	33138	118EC	13697	33147	221-170
13829	33239	4095	13008	33508	EX5482	13359	33009	119E	13698	33148	221-180
13819	33298	4595	13358	33008	EX5482	13009	33509	119E	13468	33128	223-180
13829	33239	4792	13359	33009	EX5488	13366	33016	160J	13469	33129	223-192
13578	33548	7180	13009	33509	EX5488	13368	33018	180J	13738	33438	224-180
13548	33048	7380	13359	33009	EX5495	13788	33268	18A	13739	33439	224-192
13549	33049	7395	13009	33509	EX5495	13369	33199	192J	13728	33308	225-180
13429	33249	462895	45358	33008S	HP2000	13789	33269	19B	13458	33058	226-180
13758	33708	484580	45356	33006S	HP2000-160	13789	33269	19C	13459	33059	226-195
13878	33568	522780	13518	33108	R4382	13349	33259	19E	13397	N/R	228-170
13879	33569	522791	13519	33109	R4388	13006	33006	200-160	13398	33188	228-180
13398	33188	522880	13519	33109	R4395	13358	33008	200-180	13399	33189	228-195
13399	33189	522888	25164	33641	MG3	13359	33009	200-195	13748	N/R	229-180
13918	33718	541480	25269	33607	MG22	13352	33010	200-205	13749	33279	229-195
13468	33128	541882	25278	33616	MG23	13366	33016	201-160	13376	33056	233-160
13469	33129	541888	25271	33613	MG28	13368	33018	201-180	13378	33208	233-180
13738	33438	542180	25281	33618	MG29	13369	33199	201-195	13376	33056	234-160
13726	33046	542260	25281	33618	MG30	13346	N/R	202-160	13378	33208	234-180
13728	33308	542280	25132	33621	MG32	13348	33138	202-180	13379	33209	234-192
13458	33058	542380	25134	33622	MG34	13349	33259	202-192	13518	33108	237-180
13459	33059	542395	25138	33624	MG38	13469	33129	2023-180	13519	33109	237-192
13396	N/R	542460	25140	33625	MG40	13468	33128	2023-192	13866	N/R	240-160
13398	33188	542480	25147	33630	MG47	13398	33188	2028-170	13868	33488	240-180
13399	33189	542495	25148	33631	MG48	13748	N/R	2029-180	13869	33489	240-192
13378	33208	542580	25149	33632	MG49	13749	33279	2029-195	13856	N/R	241-160
13379	33209	542595	25150	33633	MG50	13846	N/R	203-160	13858	33478	241-180
13396	N/R	542760	25151	33634	MG51	13848	33428	203-180	13859	33479	241-192
13398	33188	542780	25152	33636	MG52	13849	33429	203-195	13878	33568	242-180
13399	33189	542795	25153	33637	MG53	13376	33056	2034-160	13879	33569	242-192
13376	33056	542860	25160	33638	MG60	13378	33208	2034-180	13888	N/R	243-180
13378	33208	542880	25161	33639	MG61	13379	33209	2034-192	13889	33419	243-195
13379	33209	542895	25163	33640	MG63	13379	33209	2034-195	13008	33508	244-180
13749	33279	542995	25164	33641	MG64	13786	N/R	204-160	13009	33509	244-192
13378	33208	543380	25165	33642	MG65	13788	33268	204-180	13548	33048	245-180
13379	33209	543395	25167	33643	MG67	13789	33269	204-195	13549	33049	245-192
13376	33056	543560	25168	33644	MG68	13076	33036	206-160	13588	33518	247-180
13378	33208	543580	25174	33645	MG74	13078	33038	206-180	13496	33556	248-160
13379	33209	543591	25175	33647	MG75	13079	33039	206-195	13648	33078	248-170
13648	33078	672880	25280	33617	MG84	13826	N/R	207-160	13648	33078	248-180
14178	33558	320-180	25020	33601	S401	13828	N/R	207-180	13649	33079	248-192
13967	33747	321-170	13649	33079	672891	13829	33239	207-192	13558	33218	250-180
13978	33338	322-180	13558	33218	672980	13826	N/R	210-160	STANT	GATES	MOTORAD
13868	33488	323-180	13588	33518	673780	13828	N/R	210-180	13578	33548	260-180
13869	33489	323-192	13496	33556	674360	STANT	GATES	MOTORAD	13776	N/R	265-160
13878	33568	328-170	13558	33218	676080	13829	33239	210-192	13778	33468	265-180
14039	33889	332-180	STANT	GATES	MOTORAD	13816	N/R	211-160	13779	33469	265-195
STANT	GATES	MOTORAD	13998	33358	8110080	13819	33298	211-195	13798	33498	266-180
			14007	33447	8210070	13426	N/R	212-160	13898	N/R	267-180



## Master Automotriz 2010

### Productos Gates \* FORMAS Y DIMENSIONES

13899	33329	267-195	13649	33079	248-195	13649	33079	674395	14309	33911	349-198
13947	33737	268-170	13648	33078	249-180	13998	33088	811080	14298	33910	379-187
13948	33738	268-180	13649	33079	249-192	14536	33576	8800	14659	33939	413-192
13978	33338	270-180	13649	33079	249-195	14536	33576	880060	14589	33932	351-192
13979	33339	270-195	13588	33518	251-180	14768	33950	462-180	14667	33940	391-170
13378	33208	272-180	13476	33036	2560	14789	33952	465-190	14778	33951	431-180
14077	33867	281-170	13478	33038	2580	45356	33006S	2000-160	14757	33949	432-170
14078	33868	281-180	14157	33817	264-170	45358	33008S	2000-180	25135	33623	MG35
14147	33857	294-170	13716	33176	2660	45359	33009S	2000-195	25113	33646	MG54
14099	33069	295-185	14578	33931	269-174	45368	33198S	2001-180	25167	33643	MG55
14078	33868	296-180	13979	33339	270-192	45369	33199S	2001-192	25138	33624	MG58
14127	33877	297-170	13399	33189	272-192	45348	33258S	2002-180	25173	33655	MG73
14128	33878	297-180	48648	34027	274-174	45349	33259S	2002-192	25167	33643	MG76
14108	33798	298-180	48648	34027	274-180	45848	33428S	2003-180	25262	33605	MG20
14077	33867	299-170	14622	33936	274-198	45849	33429S	2003-195	25266	33606	MG21
14078	33868	299-180	13368	33198	276-180	45788	33268S	2004-180	25271	33613	MG24
14127	33877	301-170	13368	33198	276-192	45478	33038S	2006-180	25262	33605	MG62
14128	33878	301-180	13369	33199	276-195	45479	33039S	2006-195	25269	33607	MG69
14127	33877	302-170	13648	33078	277-180	45789	33269S	2007-192	25030	33603	S402
14128	33878	302-180	13649	33079	277-192	45758	33708S	2014-180	25010	33602	S403
14168	33838	303-180	14687	33942	282-170	45398	33188S	2015-180			
13649	33079	304-192	14188	33768	288-180	45399	33189S	2015-192			
14218	33788	307-180	13008	33508	300-180	45868	33488S	2040-180			
14068	33068	308-180	13009	33509	300-195	45869	33489S	2040-192			
14047	33907	319-170	13829	33299	306-192	45858	33478S	2041-180			
14048	33908	319-180	14248	33888	309-180	45859	33479S	2041-195			
14177	33557	320-170	14128	33878	334-180	45889	33419S	2043-195			
13349	33259	118EB	14648	33938	335-180	45356	33006S	2044-160			
13348	33258	16E	14589	33932	352-192	45358	33008S	2044-180			
13798	33498	18MB	14327	33913	418-170	45359	33009S	2044-192			
13369	33199	195J	14358	33918	419-180	45899	33329S	2067-180			
14419	33923	2000-192	14369	33919	420-195	45877	33340S	2328-170			
13359	33009	200-192	14378	33920	421-180	45878	33568S	2328-180			
13369	33199	201-192	14389	33921	422-190	45879	33569S	2328-192			
13349	33259	202-195	14399	33922	423-195	14538	33578	8100			
13349	33259	202-196	14678	33941	427-180	14537	33577	810070			
13849	33429	203-192	14429	33924	429-195	14538	33578	810080			
13789	33269	204-192	14707	33944	441-170	14537	33577	8101			
13919	33719	216-195	14818	33955	442-180		33357	811070			
13476	33036	222-160	14728	33946	447-185	14007	33447	8210			
13478	33038	222-180	14738	33947	448-180	14007	33447	821070			
13739	33439	224-195	14349	33917	449-190	14008	33448	821080			
13726	33046	225-160	14569	33930	458-192	13448	33388	8220			
13399	33189	228-192	14698	33943	461-180	13446	33386	822060			
13378	33208	230-180	14748	33948	463-183	13447	33387	822070			
13379	33209	230-192	14602	33934	467-206	13448	33388	822080			
13379	33209	230-195	14612	33935	468-213		33347	830070			
13378	33208	232-180	14632	33937	469-203	14458	33348	830080			
13379	33209	232-195	13889	33419	492895		33397	8400			
13399	33189	233-192	13878	33568	522782		33397	840070			
13399	33189	233-195	13879	33569	522788	13938	33398	840080			
13379	33209	234-195	13879	33569	522795		33397	8410			
13519	33109	237-195	13469	33129	541895	14407	33167	8700			
13848	33428	239-180	13739	33439	542195	14407	33167	870070			
13849	33429	239-192	13379	33209	543595	14408	33168	870080			
<b>STANT</b>	<b>GATES</b>	<b>MOTORAD</b>	13649	33079	672895	14537	33577	880070			
13869	33489	240-195	13648	33078	674380	14538	33578	880080			
13859	33479	241-195	<b>STANT</b>	<b>GATES</b>	<b>MOTORAD</b>	14539	33579	880090			
13879	33569	242-195	13649	33079	674388	14318	33912	343-180			
13558	33218	246-180	13649	33079	674391	<b>STANT</b>	<b>GATES</b>	<b>MOTORAD</b>			

**Master Automotriz 2010**  
**Productos Gates \* FORMAS Y DIMENSIONES**

**Juntas de salida de agua y Sello**



**Master Automotriz 2010**  
**Productos Gates \* FORMAS Y DIMENSIONES**











**Juntas de salida de agua y Sello - - (CONTINUA)**









									
V-6, 3.5 L	2007	TCK329 23394 23393 36112 T41231 37008P K060840 31284 31637 31412 T41232 T43129 38332 33914	KIT DE DISTRIBUCION MANGUERA INF. MANGUERA SUP. POLEA POLEA POLEA DECOPLADORA SERPENTIN TAPON DE ACEITE TAPON DE GASOLINA TAPON DE RADIADOR TENSOR TENSOR HIDRAULICO TENSOR MICRO-V TERMOSTATO	SIN LLAVE REGULAR (16 lbs) Sin Palanca  170°F	V-6, 3.5 L	2008	36112 K060840 31284 31637 31783 31412 T41232 38332 T43129 33914 T329 TCK329 23399 23397 T41231 36112 K060840 31284 31783 31637 31412 T41232 38332 T43129 33914 T329 TCK329 23399 23397 36112 T41231 37008P K060840 31284 31637 31412 T41232 T43129 38332 33914 T329 TCK329 23264 23265 36112 T41231 37008P K060840 31284 31637 31412 T41232 T43129 38332 33914	POLEA SERPENTIN TAPON DE ACEITE TAPON DE GASOLINA TAPON DE GASOLINA TAPONES DE RADIADOR TENSOR TENSOR TENSOR HIDRAULICO TERMOSTATOS BANDA ARBOL DE LEVAS KIT DE DISTRIBUCION MANGUERA INF. MANGUERA SUP. POLEA POLEA SERPENTIN TAPON DE ACEITE TAPON DE GASOLINA TAPON DE RADIADOR TAPONES DE RADIADOR TENSOR TENSOR TENSOR HIDRAULICO TERMOSTATOS BANDA ARBOL DE LEVAS KIT DE DISTRIBUCION MANGUERA INF. MANGUERA SUP. POLEA POLEA POLEA DECOPLADORA SERPENTIN TAPON DE ACEITE TAPON DE GASOLINA TAPON DE RADIADOR TAPONES DE RADIADOR TENSOR TENSOR HIDRAULICO TENSOR MICRO-V TERMOSTATO	SIN LLAVE CON LLAVE 16 LBS.SIN PALANCA  170°F 197 DIENTES X 20 MM  CON LLAVE SIN LLAVE 16 LBS.SIN PALANCA  170°F
V-6, 3.5 L	2006	T329 TCK329 23394 23393 36112 T41231 37008P K060840 31284 31637 31412 T41232 T43129 38332 33914	BANDA ARBOL DE LEVAS KIT DE DISTRIBUCION MANGUERA INF. MANGUERA SUP. POLEA POLEA POLEA DECOPLADORA SERPENTIN TAPON DE ACEITE TAPON DE GASOLINA TAPON DE RADIADOR TENSOR TENSOR HIDRAULICO TENSOR MICRO-V TERMOSTATO	SIN LLAVE REGULAR (16 lbs) Sin Palanca  170°F	V-6, 3.2 L	2007	T329 TCK329 23399 23397 36112 T41231 37008P K060840 31284 31637 31412 T41232 T43129 38332 33914 T329 TCK329 23399 23397 36112 T41231 37008P K060840 31284 31637 31412 T41232 T43129 38332 33914 T329 TCK329 23264 23265 36112 T41231 37008P K060840 31284 31637 31412 T41232 T43129 38332 33914	BANDA ARBOL DE LEVAS KIT DE DISTRIBUCION MANGUERA INF. MANGUERA SUP. POLEA POLEA POLEA DECOPLADORA SERPENTIN TAPON DE ACEITE TAPON DE GASOLINA TAPON DE RADIADOR TAPONES DE RADIADOR TENSOR TENSOR TENSOR HIDRAULICO TERMOSTATOS BANDA ARBOL DE LEVAS KIT DE DISTRIBUCION MANGUERA INF. MANGUERA SUP. POLEA POLEA POLEA DECOPLADORA SERPENTIN TAPON DE ACEITE TAPON DE GASOLINA TAPON DE RADIADOR TAPONES DE RADIADOR TENSOR TENSOR HIDRAULICO TENSOR MICRO-V TERMOSTATO	SIN LLAVE REGULAR (16 lbs) Sin Palanca  170°F

**TL**

V-6, 3.5 L	2010	T329 TCK329 T41231 36112 K060468 T41232 T43129	BANDA ARBOL DE LEVAS KIT DE DISTRIBUCION POLEA POLEA SERPENTIN TENSOR TENSOR HIDRAULICO	197 DIENTES X 20 MM	V-6, 3.2 L	2006	T329 TCK329 23264 23265 36112 T41231 37008P K060840 31284 31637 31412 T41232 T43129 38332 33914 T329 TCK329 23264 23265 36112 T41231 37008P K060840 31284 31637 31412 T41232 T43129 38332 33914	BANDA ARBOL DE LEVAS KIT DE DISTRIBUCION MANGUERA INF. MANGUERA SUP. POLEA POLEA POLEA DECOPLADORA SERPENTIN TAPON DE ACEITE TAPON DE GASOLINA TAPON DE RADIADOR TAPONES DE RADIADOR TENSOR TENSOR HIDRAULICO TENSOR MICRO-V TERMOSTATO	SIN LLAVE REGULAR (16 lbs) Sin Palanca  170°F
V-6, 3.7 L	2010	T329 TCK329 36112 T41231 K060468 T41232 T43129	BANDA ARBOL DE LEVAS KIT DE DISTRIBUCION POLEA POLEA SERPENTIN TENSOR TENSOR HIDRAULICO	197 DIENTES X 20 MM	V-6, 3.2 L	2006	T329 TCK329 23264 23265 36112 T41231 37008P K060840 31284 31637 31412 T41232 T43129 38332 33914 T329 TCK329 23264 23265 36112 T41231 37008P K060840 31284 31637 31412 T41232 T43129 38332 33914	BANDA ARBOL DE LEVAS KIT DE DISTRIBUCION MANGUERA INF. MANGUERA SUP. POLEA POLEA POLEA DECOPLADORA SERPENTIN TAPON DE ACEITE TAPON DE GASOLINA TAPON DE RADIADOR TAPONES DE RADIADOR TENSOR TENSOR HIDRAULICO TENSOR MICRO-V TERMOSTATO	SIN LLAVE REGULAR (16 lbs) Sin Palanca  170°F
V-6, 3.5 L	2009	T329 TCK329 T41231 36112 K060468 31284 31783 31637 31412 T41232 T43129 33914	BANDA ARBOL DE LEVAS KIT DE DISTRIBUCION POLEA POLEA SERPENTIN TAPON DE ACEITE TAPON DE GASOLINA TAPON DE GASOLINA TAPONES DE RADIADOR TENSOR TENSOR HIDRAULICO TERMOSTATOS	197 DIENTES X 20 MM  CON LLAVE SIN LLAVE 16 LBS.SIN PALANCA	V-6, 3.2 L	2009	T329 TCK329 23264 23265 36112 T41231 37008P K060840 31284 31637 31412 T41232 T43129 38332 33914	BANDA ARBOL DE LEVAS KIT DE DISTRIBUCION MANGUERA INF. MANGUERA SUP. POLEA POLEA POLEA DECOPLADORA SERPENTIN TAPON DE ACEITE TAPON DE GASOLINA TAPON DE RADIADOR TAPONES DE RADIADOR TENSOR TENSOR HIDRAULICO TENSOR MICRO-V TERMOSTATO	SIN LLAVE REGULAR (16 lbs) Sin Palanca  170°F

**TSX**

V-6, 3.7 L	2009	T329 TCK329 T41231 36112 K060468 31284 31783 31637 31412 T41232 T43129 33914	BANDA ARBOL DE LEVAS KIT DE DISTRIBUCION POLEA POLEA SERPENTIN TAPON DE ACEITE TAPON DE GASOLINA TAPON DE GASOLINA TAPONES DE RADIADOR TENSOR TENSOR HIDRAULICO TERMOSTATOS	197 DIENTES X 20 MM  CON LLAVE SIN LLAVE 16 LBS.SIN PALANCA	4 CIL, 2.4 L  V-6, 3.5 L	2010	19498 K070694 T329 TCK329 36112 T41231 K060468 T41232 T43129 36320 K070694 31637 31783 31412 39073 34050	MANGUERA DE PASO SERPENTIN BANDA ARBOL DE LEVAS KIT DE DISTRIBUCION POLEA POLEA SERPENTIN TENSOR TENSOR HIDRAULICO POLEA SERPENTIN TAPON DE GASOLINA TAPON DE GASOLINA TAPONES DE RADIADOR TENSOR TERMOSTATOS	197 DIENTES X 20 MM  SIN LLAVE CON LLAVE 16 LBS.SIN PALANCA  172°F
------------	------	---	--	---	--------------------------------	------	---	--	--



**ALFA ROMEO**

**ALFA 147**

4 CIL, 2.0 L	2006	T791 K060424 K060775 K060420 K060780	BANDA ARBOL DE LEVAS SERPENTIN SERPENTIN SERPENTIN SERPENTIN	168 DIENTES X 24 MM SIN A.A. NUM. MOTOR 28357 CON A.A. NUM. MOTOR 28357 SIN A.A. NUM. MOTOR 28357 CON A.A. NUM. MOTOR 28357
4 CIL, 2.0 L	2005	T791 K060420 K060424 K060775 K060780	BANDA ARBOL DE LEVAS SERPENTIN SERPENTIN SERPENTIN SERPENTIN	168 DIENTES X 24 MM SIN A.A. NUM. MOTOR 28357 SIN A.A. NUM. MOTOR 28357 CON A.A. NUM. MOTOR 28357 CON A.A. NUM. MOTOR 28357
4 CIL, 2.0 L	2004	T791 K060420 K060775 K060780 K060424	BANDA ARBOL DE LEVAS SERPENTIN SERPENTIN SERPENTIN SERPENTIN	168 DIENTES X 24 MM SIN A.A. NUM. MOTOR 28357 CON A.A. NUM. MOTOR 28357 CON A.A. NUM. MOTOR 28357 SIN A.A. NUM. MOTOR 28357

**ALFA 159**

4 CIL, 2.2 L	2007	K050425	SERPENTIN	ALTERNADOR
4 CIL, 2.2 L	2006	K050425	SERPENTIN	ALTERNADOR
4 CIL, 2.2 L	2005	K050425	SERPENTIN	ALTERNADOR

**ALFA BRERA**

V-6, 3.2 L	2007	K060845	SERPENTIN	ALTERNADOR
V-6, 3.2 L	2006	K060845	SERPENTIN	ALTERNADOR

**AUDI**











**A3**

4 CIL, 2.0 L	2009	37013P K060439	POLEA DECOPLADORA SERPENTIN	
4 CIL, 2.0 L	2008	T334 T42019 38018 37013P K060415 31100 31613 31708 31529 TH11287G1	BANDA ARBOL DE LEVAS POLEA POLEA POLEA DECOPLADORA SERPENTIN TAPON DE ACEITE TAPON DE GASOLINA TAPON DE GASOLINA TAPONES DE RADIADOR TERMOSTATOS	148 DIENTES X 23 MM      SIN LLAVE CON LLAVE 22 LBS. 189°F
V-6, 3.2 L	2008	36300 37013P K060635 31100 31613 31708 31529 38450	POLEA POLEA DECOPLADORA SERPENTIN TAPON DE ACEITE TAPON DE GASOLINA TAPON DE GASOLINA TAPONES DE RADIADOR TENSOR	   SIN LLAVE CON LLAVE 22 LBS.
4 CIL, 2.0 L	2007	T334 38018 37013P K060415 31100 31708 31613 31529 TH11287G1 TH11287G1	BANDA ARBOL DE LEVAS POLEA POLEA DECOPLADORA SERPENTIN TAPON DE ACEITE TAPON DE GASOLINA TAPON DE GASOLINA TAPON DE RADIADOR TERMOSTATO TERMOSTATO	   CON LLAVE SIN LLAVE REGULAR (22 lbs) Sin Palanca 189°F 189°F
V-6, 3.2 L	2007	36300 37013P K060635 31100 31708 31613	POLEA POLEA DECOPLADORA SERPENTIN TAPON DE ACEITE TAPON DE GASOLINA TAPON DE GASOLINA	   CON LLAVE SIN LLAVE REGULAR (22 lbs) Sin Palanca

4 CIL, 2.0 L	2006	31529 38450 T334 T42019 38018 37013P K060415 31100 31613 31708 31529 TH11287G1 TH11287G1	TAPON DE RADIADOR TENSOR BANDA ARBOL DE LEVAS POLEA POLEA POLEA DECOPLADORA SERPENTIN TAPON DE ACEITE TAPON DE GASOLINA TAPON DE GASOLINA TAPONES DE RADIADOR TERMOSTATO TERMOSTATO	(22 lbs) Sin Palanca  148 DIENTES X 23 MM      SIN LLAVE CON LLAVE 22 LBS. 189°F 189°F
--------------	------	--	---	--

**A4**

V-6, 3.2 L	2009	38015 K060950 31529 38423	POLEA DEL TENSOR SERPENTIN TAPONES DE RADIADOR TENSOR	22 LBS.
V-6, 3.2 L	2008	38015 K060950 31529 38423	POLEA DEL TENSOR SERPENTIN TAPONES DE RADIADOR TENSOR	22 LBS.
4 CIL, 2.0 L	2007	T334 K060620 31613 31529 38207 38015 K060950 31613 31529 38423	BANDA ARBOL DE LEVAS SERPENTIN TAPON DE GASOLINA TAPON DE RADIADOR TENSOR MICRO-V POLEA SERPENTIN TAPON DE GASOLINA TAPON DE RADIADOR TENSOR	  SIN LLAVE REGULAR (22 lbs) Sin Palanca   SIN LLAVE REGULAR (22 lbs) Sin Palanca
4 CIL, 1.8 L	2006	T306 TCK306 T42019 K060620 31613 31529 T43018 T43028 38207 T330 TCK330 T42137 T42138 K060730 K060739 31613 31529 T41086 38406 T43027	BANDA ARBOL DE LEVAS KIT DE DISTRIBUCION POLEA SERPENTIN TAPON DE GASOLINA TAPON DE RADIADOR TENSOR TENSOR HIDRAULICO TENSOR MICRO-V BANDA ARBOL DE LEVAS KIT DE DISTRIBUCION POLEA POLEA SERPENTIN SERPENTIN TAPON DE GASOLINA TAPON DE RADIADOR TENSOR TENSOR TENSOR HIDRAULICO POLEA	    SIN LLAVE REGULAR (22 lbs) Sin Palanca          22 LBS.
V-6, 3.2 L	2006	38015 K060950 31529 38423	POLEA SERPENTIN TAPONES DE RADIADOR TENSOR	22 LBS.
4 CIL, 1.8 L	2005	K060620 31708 31529 38207	SERPENTIN TAPON DE GASOLINA TAPON DE RADIADOR TENSOR MICRO-V	CON LLAVE REGULAR (22 lbs) Sin Palanca
V-6, 3.0 L	2005	K060730 K060739 31613 31529	SERPENTIN SERPENTIN TAPON DE GASOLINA TAPON DE RADIADOR	C/VENT. VISCOUS S/VENT. VISCOUS SIN LLAVE REGULAR (22 lbs) Sin Palanca
4 CIL, 1.8 L	2004	T306 K060625 31100 31613 31529 38207 T330 K060739 K060730	BANDA ARBOL DE LEVAS SERPENTIN TAPON DE ACEITE TAPON DE GASOLINA TAPON DE RADIADOR TENSOR MICRO-V BANDA ARBOL DE LEVAS SERPENTIN TAPON DE ACEITE TAPON DE GASOLINA TAPON DE RADIADOR TENSOR MICRO-V BANDA ARBOL DE LEVAS SERPENTIN	       SIN LLAVE REGULAR (22 lbs) Sin Palanca      SIN LLAVE REGULAR (22 lbs) Sin Palanca
V-6, 3.0 L	2004	T330 K060739 K060730	BANDA ARBOL DE LEVAS SERPENTIN SERPENTIN	SIN VENTILADOR CON VENTILADOR

    				    					
V-6, 3.0 L	2004	31100 31613 31529	TAPON DE ACEITE TAPON DE GASOLINA TAPON DE RADIADOR	SIN LLAVE REGULAR (22 lbs) Sin Palanca	4 CIL, 1.8 L	1998	33069 K040338 T291 7208 38068 K050510	TERMOSTATO A.A. BANDA ARBOL DE LEVAS D.H. POLEA SERPENTIN	195°F C/DH C/AA, C/DH A.A. C/AA, C/DH
4 CIL, 1.8 L	2003	T306 K060625 31100 31833 31529 38207	BANDA ARBOL DE LEVAS SERPENTIN TAPON DE ACEITE TAPON DE GASOLINA TAPON DE RADIADOR TENSOR MICRO-V	SIN LLAVE REGULAR (22 lbs) Sin Palanca			31100 31781 31833 31529 38151 33923	TAPON DE ACEITE TAPON DE GASOLINA TAPON DE RADIADOR TAPON DE GASOLINA TAPON DE RADIADOR TENSOR MICRO-V	CON LLAVE REGULAR SIN LLAVE REGULAR (22 lbs) Sin Palanca
V-6, 3.0 L	2003	T330 K060739 K060730 31100 31833 31529	BANDA ARBOL DE LEVAS SERPENTIN SERPENTIN TAPON DE ACEITE TAPON DE GASOLINA TAPON DE RADIADOR	S/VENT. VISCOUS C/VENT. VISCOUS	V-6, 2.8 L	1998	T297 K060739 31100 31781 31833 31529 38193 33069	BANDA ARBOL DE LEVAS SERPENTIN TAPON DE ACEITE TAPON DE GASOLINA TAPON DE RADIADOR TENSOR MICRO-V TERMOSTATO BANDA ARBOL DE LEVAS	195°F C/AA, C/DH TIPTRONIC
4 CIL, 1.8 L	2002	K040335 T306 31100 31833 31529 38151 33923 K050510	A.A. BANDA ARBOL DE LEVAS TAPON DE ACEITE TAPON DE GASOLINA TAPON DE RADIADOR TENSOR MICRO-V TERMOSTATO VENT. ALT Y D.H.	SIN LLAVE REGULAR (22 lbs) Sin Palanca ALTERNADOR 195°F			31100 31781 31833 31529 38193 33069	TAPON DE ACEITE TAPON DE GASOLINA TAPON DE RADIADOR TAPON DE GASOLINA TAPON DE RADIADOR TENSOR MICRO-V TERMOSTATO	CON LLAVE REGULAR SIN LLAVE REGULAR (22 lbs) Sin Palanca 195°F
V-6, 3.0 L	2002	T330 K060730 K060739 31100 31833 31781 31529	BANDA ARBOL DE LEVAS SERPENTIN SERPENTIN TAPON DE ACEITE TAPON DE GASOLINA TAPON DE GASOLINA TAPON DE RADIADOR	C/VENT. VISCOUS S/VENT. VISCOUS	V-6, 3.2 L	2008	38015 K060950 31529 38423	POLEA DEL TENSOR SERPENTIN TAPONES DE RADIADOR TENSOR	22 LBS.
4 CIL, 1.8 L	2001	T291 T317 T306 38068 K040335 K050510 31100 31781 31529 38151 33079	BANDA ARBOL DE LEVAS BANDA ARBOL DE LEVAS BANDA ARBOL DE LEVAS POLEA SERPENTIN SERPENTIN TAPON DE ACEITE TAPON DE GASOLINA TAPON DE RADIADOR TENSOR MICRO-V TERMOSTATO	SIN LLAVE REGULAR CON LLAVE REGULAR (22 lbs) Sin Palanca A.A. A.A. VENT ALT. & D.H.	V-6, 3.2 L V-6, 3.0 L V-6, 3.2 L	2007	38015 K060950 31613 31529 38423	POLEA SERPENTIN TAPON DE GASOLINA TAPON DE RADIADOR TENSOR	SIN LLAVE REGULAR (22 lbs) Sin Palanca
4 CIL, 1.8 L	2000	T291 T317 19793 22465 38068 K050510 K040335 31100 31781 31529 38151 33079	BANDA ARBOL DE LEVAS BANDA ARBOL DE LEVAS CALEF. A TUBO-1 MANG. INF. POLEA SERPENTIN SERPENTIN TAPON DE ACEITE TAPON DE GASOLINA TAPON DE RADIADOR TENSOR MICRO-V TERMOSTATO	CON LLAVE REGULAR (22 lbs) Sin Palanca 195°F	V-6, 3.0 L V-6, 3.2 L V-6, 3.0 L	2006	38015 K060950 31832 31529 38423	POLEA SERPENTIN TAPON DE GASOLINA TAPON DE RADIADOR POLEA SERPENTIN TAPONES DE RADIADOR TENSOR	SIN LLAVE REGULAR (22 lbs) Sin Palanca
V-6, 2.8 L	2000	T297 K060739 31100 31781 31529 38193 33069	BANDA ARBOL DE LEVAS SERPENTIN TAPON DE ACEITE TAPON DE GASOLINA TAPON DE RADIADOR TENSOR MICRO-V TERMOSTATO	C/AA, C/DH TIPTRONIC	V-6, 3.0 L V-6, 3.0 L	2006	38015 K060950 31832 31529 38423	POLEA SERPENTIN TAPON DE GASOLINA TAPON DE RADIADOR POLEA SERPENTIN TAPONES DE RADIADOR TENSOR	22 LBS.
4 CIL, 1.8 L	1999	K040338 T317 T291 19793 6208 GS 7208 38068 31100 31781 38151 K050510	A.A. BANDA ARBOL DE LEVAS BANDA ARBOL DE LEVAS CALEF. A TUBO-1 D.H. D.H. POLEA TAPON DE ACEITE TAPON DE GASOLINA TENSOR MICRO-V VENT. ALT Y D.H.	A.A. VENT ALT. & D.H. A.A. CON LLAVE REGULAR (22 lbs) Sin Palanca 195°F	V-6, 3.0 L V-6, 3.0 L V-6, 2.8 L	2004	K060739 31780 31832 31529 K060739 31780 31832 31529	SERPENTIN TAPON DE GASOLINA TAPON DE RADIADOR SERPENTIN TAPON DE GASOLINA TAPON DE GASOLINA TAPON DE RADIADOR SERPENTIN	SIN LLAVE REGULAR (22 lbs) Sin Palanca CON VENTILADOR SIN VENTILADOR CON LLAVE REGULAR SIN LLAVE REGULAR (22 lbs) Sin Palanca
V-6, 2.8 L	2000	T297 K060739 31100 31781 31529 38193 33069	BANDA ARBOL DE LEVAS SERPENTIN TAPON DE ACEITE TAPON DE GASOLINA TAPON DE RADIADOR TENSOR MICRO-V TERMOSTATO	C/AA, C/DH TIPTRONIC	V-6, 3.0 L V-6, 2.8 L	2005	38015 K060950 31832 31529 38423	POLEA SERPENTIN TAPON DE GASOLINA TAPON DE RADIADOR POLEA SERPENTIN TAPONES DE RADIADOR TENSOR	22 LBS.
4 CIL, 1.8 L	1999	K040338 T317 T291 19793 6208 GS 7208 38068 31100 31781 38151 K050510	A.A. BANDA ARBOL DE LEVAS BANDA ARBOL DE LEVAS CALEF. A TUBO-1 D.H. D.H. POLEA TAPON DE ACEITE TAPON DE GASOLINA TENSOR MICRO-V VENT. ALT Y D.H.	A.A. VENT ALT. & D.H. A.A. CON LLAVE REGULAR (22 lbs) Sin Palanca 195°F	V-6, 3.0 L V-6, 3.0 L V-6, 2.8 L	2005	38015 K060950 31832 31529 38423	POLEA SERPENTIN TAPON DE GASOLINA TAPON DE RADIADOR POLEA SERPENTIN TAPONES DE RADIADOR TENSOR	22 LBS.
V-6, 2.8 L	1999	T297 K060739 31100 31781 38193 K050510	BANDA ARBOL DE LEVAS SERPENTIN TAPON DE ACEITE TAPON DE GASOLINA TENSOR MICRO-V VENT. ALT Y D.H.	C/AA, C/DH TIPTRONIC	V-6, 2.8 L	2001	T297 19790 K060739 31100 31781 31529 38193 33079	BANDA ARBOL DE LEVAS CALEF. A TUBO-1 SERPENTIN TAPON DE ACEITE TAPON DE GASOLINA TAPON DE RADIADOR TENSOR MICRO-V TERMOSTATO	195°F
V-6, 2.8 L	1999	T297 K060739 31100 31781 38193 K050510	BANDA ARBOL DE LEVAS SERPENTIN TAPON DE ACEITE TAPON DE GASOLINA TENSOR MICRO-V VENT. ALT Y D.H.	C/AA, C/DH TIPTRONIC	V-6, 2.8 L	2000	T297 19790 K060739 31100 31781 38193	BANDA ARBOL DE LEVAS CALEF. A TUBO-1 SERPENTIN TAPON DE ACEITE TAPON DE GASOLINA TENSOR MICRO-V	{253 D x 30.0 mm}
V-6, 2.8 L	1999	T297 K060739 31100 31781 38193	BANDA ARBOL DE LEVAS SERPENTIN TAPON DE ACEITE TAPON DE GASOLINA TENSOR MICRO-V	C/AA, C/DH TIPTRONIC	V-6, 2.8 L	2000	T297 19790 K060739 31100 31781 38193	BANDA ARBOL DE LEVAS CALEF. A TUBO-1 SERPENTIN TAPON DE ACEITE TAPON DE GASOLINA TAPON DE RADIADOR	C/AA, C/DH CON LLAVE REGULAR (22 lbs) Sin Palanca

## A6

V-6, 2.8 L V-6, 2.8 L	2000 1999	38193 T297 19790 K060739 31781 31335 38193	TENSOR MICRO-V BANDA ARBOL DE LEVAS CALEF. A TUBO-1 SERPENTIN TAPON DE GASOLINA TAPON DE RADIADOR TENSOR MICRO-V	C/AA, C/DH CON LLAVE REGULAR (20 lbs) Sin palanca
V-6, 2.8 L	1998	T297 K060739 31100 31833 31529 38193 33069	BANDA ARBOL DE LEVAS SERPENTIN TAPON DE ACEITE TAPON DE GASOLINA TAPON DE RADIADOR TENSOR MICRO-V TERMOSTATO	C/AA, C/DH SIN LLAVE REGULAR (22 lbs) Sin Palanca 195°F

V-8, 3.7 L	1999	33069 T207 38093 K061058 31100 31833 31781 31335 33069	TERMOSTATO BANDA ARBOL DE LEVAS POLEA LOCA SERPENTIN TAPON DE ACEITE TAPON DE GASOLINA TAPON DE RADIADOR TERMOSTATO	C/AA, C/DH TIPTRONIC SIN LLAVE REGULAR CON LLAVE REGULAR (20 lbs) Sin palanca 195°F
V-8, 4.2 L	1999	T207 38093 K061045 31100 31781 31335 33069	BANDA ARBOL DE LEVAS POLEA SERPENTIN TAPON DE ACEITE TAPON DE GASOLINA TAPON DE RADIADOR TERMOSTATO	C/AA, C/DH TIPTRONIC SIN LLAVE REGULAR (20 lbs) Sin palanca 195°F
V-8, 3.7 L	1998	T207 38093 K061058 31833 31335 33069	BANDA ARBOL DE LEVAS POLEA LOCA SERPENTIN TAPON DE GASOLINA TAPON DE RADIADOR TERMOSTATO	C/AA, C/DH TIPTRONIC SIN LLAVE REGULAR (20 lbs) Sin palanca 195°F

**A8**

V8, 4.2 L	2009	K050448 31529 33518	SERPENTIN TAPONES DE RADIADOR TERMOSTATOS	22 LBS. 176°
V8, 4.2 L	2008	K050448 31529 33518	SERPENTIN TAPONES DE RADIADOR TERMOSTATOS	22 LBS. 176°
V8, 4.2 L	2007	T43032 38451	TENSOR TENSOR	
V-8, 4.2 L	2007	T297 TCK297 K071005 31833 31529	BANDA ARBOL DE LEVAS KIT DE DISTRIBUCION SERPENTIN TAPON DE GASOLINA TAPON DE RADIADOR	SIN LLAVE REGULAR (22 lbs) Sin Palanca
V-8, 4.2 L	2006	T297 38093 K061045 31833 31335 33069	BANDA ARBOL DE LEVAS POLEA LOCA SERPENTIN TAPON DE GASOLINA TAPON DE RADIADOR TERMOSTATO	C/AA, C/DH SIN LLAVE REGULAR (20 lbs) Sin palanca 195°F
V-8, 4.2 L	2005	T297 38093 K061045 31833 31335 33069	BANDA ARBOL DE LEVAS POLEA LOCA SERPENTIN TAPON DE GASOLINA TAPON DE RADIADOR TERMOSTATO	C/AA, C/DH SIN LLAVE REGULAR (20 lbs) Sin palanca 195°F
V-8, 4.2 L	2004	T297 38093 K061045 31833 31335 33069	BANDA ARBOL DE LEVAS POLEA LOCA SERPENTIN TAPON DE GASOLINA TAPON DE RADIADOR TERMOSTATO	C/AA, C/DH SIN LLAVE REGULAR (20 lbs) Sin palanca 195°F
V-8, 3.7 L V-8, 4.2 L	2003	31781 T297 38093 K061045 31833 31335 33069	TAPON DE GASOLINA BANDA ARBOL DE LEVAS POLEA LOCA SERPENTIN TAPON DE GASOLINA TAPON DE RADIADOR TERMOSTATO	CON LLAVE REGULAR
V-8, 3.7 L V-8, 4.2 L	2002	31781 T297 38093 K061045 31833 31335 33069	TAPON DE GASOLINA BANDA ARBOL DE LEVAS POLEA LOCA SERPENTIN TAPON DE GASOLINA TAPON DE RADIADOR TERMOSTATO	CON LLAVE REGULAR
V-8, 4.2 L	2001	T297 38093 K061045 31100 31833 31335 33069	BANDA ARBOL DE LEVAS POLEA LOCA SERPENTIN TAPON DE ACEITE TAPON DE GASOLINA TAPON DE RADIADOR TERMOSTATO	C/AA, C/DH SIN LLAVE REGULAR (20 lbs) Sin palanca 195°F
V-8, 4.2 L	2000	T297 38093 K061045 31100 31781 31335	BANDA ARBOL DE LEVAS POLEA LOCA SERPENTIN TAPON DE ACEITE TAPON DE GASOLINA TAPON DE RADIADOR	C/AA, C/DH, TIPTRONIC CON LLAVE REGULAR (20 lbs) Sin palanca

**A8 QUATTRO**

V-8, 4.2 L	2005	T297 K071005 31613 31529	BANDA ARBOL DE LEVAS SERPENTIN TAPON DE GASOLINA TAPON DE RADIADOR	SIN LLAVE REGULAR (22 lbs) Sin Palanca
V-8, 4.2 L	2004	T297 K061058 31832 31529	BANDA ARBOL DE LEVAS SERPENTIN TAPON DE GASOLINA TAPON DE RADIADOR	SIN LLAVE REGULAR (22 lbs) Sin Palanca
V-8, 4.2 L	2003	31781	TAPON DE GASOLINA	CON LLAVE REGULAR
V-8, 4.2 L	2002	31781	TAPON DE GASOLINA	CON LLAVE REGULAR
V-8, 4.2 L	2001	31781 33069	TAPON DE GASOLINA TERMOSTATO	CON LLAVE REGULAR 195°F
V-8, 4.2 L	2000	T297 38093 K061045 31781 31335 33069	BANDA ARBOL DE LEVAS POLEA LOCA SERPENTIN TAPON DE GASOLINA TAPON DE RADIADOR TERMOSTATO	CON LLAVE REGULAR (20 lbs) Sin palanca 195°F
V-8, 4.2 L	1999	T207 38093 K061058 31781 31335 33069	BANDA ARBOL DE LEVAS POLEA LOCA SERPENTIN TAPON DE GASOLINA TAPON DE RADIADOR TERMOSTATO	{299 D x 30.0 mm} CON LLAVE REGULAR (20 lbs) Sin palanca 195°F

**ALLROAD QUATTRO**

V-6, 2.7 L	2006	T297 K060730 31100 31832 31529 38193 33069	BANDA ARBOL DE LEVAS SERPENTIN TAPON DE ACEITE TAPON DE GASOLINA TAPON DE RADIADOR TENSOR MICRO-V TERMOSTATO	SIN LLAVE REGULAR (22 lbs) Sin Palanca 195°F
V-6, 2.7 L	2005	T297 K060730 31100 31832 31529 38193 33069	BANDA ARBOL DE LEVAS SERPENTIN TAPON DE ACEITE TAPON DE GASOLINA TAPON DE RADIADOR TENSOR MICRO-V TERMOSTATO	SIN LLAVE REGULAR (22 lbs) Sin Palanca 195°F
V-6, 2.7 L	2004	T297 K060730 31100 31832 31529 38193 33069	BANDA ARBOL DE LEVAS SERPENTIN TAPON DE ACEITE TAPON DE GASOLINA TAPON DE RADIADOR TENSOR MICRO-V TERMOSTATO	SIN LLAVE REGULAR (22 lbs) Sin Palanca 195°F
V-6, 2.7 L	2003	T297 K060730 31100	BANDA ARBOL DE LEVAS SERPENTIN TAPON DE ACEITE	195°F

V-6, 2.7 L	2003	31833 31529 38193 33069	TAPON DE GASOLINA TAPON DE RADIADOR TENSOR MICRO-V TERMOSTATO	SIN LLAVE REGULAR (22 lbs) Sin Palanca 195°F
V-6, 2.7 L	2002	T297 K060730 31100 31833 31529 38193	BANDA ARBOL DE LEVAS SERPENTIN TAPON DE ACEITE TAPON DE GASOLINA TAPON DE RADIADOR TENSOR MICRO-V	SIN LLAVE REGULAR (22 lbs) Sin Palanca

4 CIL, 1.8 L	2003	38148 33923 T306 37013P 38018 6DPK1200	TENSOR MICRO-V TERMOSTATO BANDA ARBOL DE LEVAS POLEA DECOPLADORA POLEA DEL TENSOR SERPENTIN	195°F
		31100 31781 31529 38148 33923	TAPON DE ACEITE TAPON DE GASOLINA TAPON DE RADIADOR TENSOR MICRO-V TERMOSTATO	CON LLAVE REGULAR (22 lbs) Sin Palanca 195°F

**Q5**

V-6, 3.2 L	2009	K060947 38423	SERPENTIN TENSOR	4 CIL, 1.8 L
------------	------	------------------	---------------------	--------------

4 CIL, 1.8 L	2002	T306 37013P 38018 6DPK1200	BANDA ARBOL DE LEVAS POLEA DECOPLADORA POLEA DEL TENSOR SERPENTIN	195°F
--------------	------	-------------------------------------	--	-------

**Q7**

V-6, 3.6 L	2009	DK070817 38317	SERPENTIN TENSOR	4 CIL, 1.8 L
V-6, 3.6 L	2008	DK070817 38317	SERPENTIN TENSOR	
V-6, 3.6 L	2007	DK070817 38317	SERPENTIN TENSOR MICRO-V	
V-8, 4.2 L	2007	K050440 31529	SERPENTIN TAPON DE RADIADOR	

4 CIL, 1.8 L	2001	T306 38018 37013P 6DPK1200	BANDA ARBOL DE LEVAS POLEA POLEA DECOPLADORA SERPENTIN	195°F
		31100 31781 31529 38148 33923	TAPON DE ACEITE TAPON DE GASOLINA TAPON DE RADIADOR TENSOR MICRO-V TERMOSTATO	CON LLAVE REGULAR (22 lbs) Sin Palanca

**S4 QUATTRO**

V-6, 2.7 L	2002	T297 K060682 K060730 31100 31529 38193 33069	BANDA ARBOL DE LEVAS SERPENTIN SERPENTIN TAPON DE ACEITE TAPON DE RADIADOR TENSOR MICRO-V TERMOSTATO	S/AA C/AA (22 lbs) Sin Palanca 195°F	4 CIL, 1.8 L
V-6, 2.7 L	2001	T297 K060682 K060730 31100 31529 38193 33069	BANDA ARBOL DE LEVAS SERPENTIN SERPENTIN TAPON DE ACEITE TAPON DE RADIADOR TENSOR MICRO-V TERMOSTATO	S/AA C/AA (22 lbs) Sin Palanca 195°F	
V-6, 2.7 L	2000	T297 K060730 K060682 31100 31529 38193 33069	BANDA ARBOL DE LEVAS SERPENTIN SERPENTIN TAPON DE ACEITE TAPON DE RADIADOR TENSOR MICRO-V TERMOSTATO	C/AA S/AA (22 lbs) Sin Palanca 195°F	

4 CIL, 1.8 L	2000	T306 37013P 38018 6DPK1200	BANDA ARBOL DE LEVAS POLEA DECOPLADORA POLEA TENSORA SERPENTIN	195°F	
		31100 31781 31529 38148 33923	TAPON DE ACEITE TAPON DE GASOLINA TAPON DE RADIADOR TENSOR MICRO-V TERMOSTATO	CON LLAVE REGULAR (22 lbs) Sin Palanca 195°F	

**BMW**

**318I**

4 CIL, 1.9 L	1998	K040350 K060682 22509 22635 38070 38071 31282 31847 31332 38223 33937	A.A. ALT. MANG. INF. MANG. SUP. POLEA POLEA TAPON DE ACEITE TAPON DE GASOLINA TAPON DE RADIADOR TENSOR MICRO-V TERMOSTATO	A.A. ALT, B. AGUA Y D.H. (30 lbs) Sin Palanca ALT, B. AGUA Y D.H. 195°F
--------------	------	---	---	---

**TT**

V-6, 3.2 L 4 CIL, 1.8 L	2007 2006	K060635 T306 38018 6DPK1200 31100 31833 31529 38148 33923	SERPENTIN BANDA ARBOL DE LEVAS POLEA SERPENTIN TAPON DE ACEITE TAPON DE GASOLINA TAPON DE RADIADOR TENSOR MICRO-V TERMOSTATO	SIN LLAVE REGULAR (22 lbs) Sin Palanca 195°F	4 CIL, 1.8 L
	2005	T306 38018 6DPK1200 31100 31833 31529 38148 33923	BANDA ARBOL DE LEVAS POLEA TENSORA SERPENTIN TAPON DE ACEITE TAPON DE GASOLINA TAPON DE RADIADOR TENSOR MICRO-V TERMOSTATO	6DPK1195 SIN LLAVE REGULAR (22 lbs) Sin Palanca 195°F	
4 CIL, 1.8 L	2004	T306 38018 6DPK1200 31100 31781 31529	BANDA ARBOL DE LEVAS POLEA DEL TENSOR SERPENTIN TAPON DE ACEITE TAPON DE GASOLINA TAPON DE RADIADOR	C/AA CON LLAVE REGULAR (22 lbs) Sin Palanca	

**318TI**

4 CIL, 1.9 L	1999	K040350 K060682 22509 22635 38071 38070 31100 31847 31332 38223 33937	A.A. ALT. MANGUERA INF. MANGUERA SUP. POLEA LOCA POLEA LOCA TAPON DE ACEITE TAPON DE GASOLINA TAPON DE RADIADOR TENSOR MICRO-V TERMOSTATO	ALT., B.A., & D.H. A.A. (30 lbs) Sin Palanca ALT, B. AGUA Y D.H. 195°F
4 CIL, 1.9 L	1998	K040350 K060682 22509 22635 38070	A.A. ALT. MANG. INF. MANG. SUP. POLEA LOCA	A.A.





6 CIL, 2.5 L	2004	38201 38221	TENSOR MICRO-V TENSOR MICRO-V	ALT, B. AGUA Y D.H. ALT, B. AGUA Y D.H.

6 CIL, 3.0 L	2002	31848 38201 38221 33934	TAPON DE GASOLINA TENSOR MICRO-V TENSOR MICRO-V TERMOSTATO	ALT, B. AGUA Y D.H. ALT, B. AGUA Y D.H. 195°F

## 328I

V-6, 2.8 L	2000	K050340 K060605 22638 22639 38071 31100 31848 31332 38224 38201 33934	A.A. ALT. MANG. SUP. MANGUERA INF. POLEA TENSORA TAPON DE ACEITE TAPON DE GASOLINA TAPON DE RADIADOR TENSOR MICRO-V TENSOR MICRO-V TERMOSTATO	C/DH C/AA, C/DH ALT., B.A., & D.H. (30 lbs) Sin Palanca A.A. ALT., B.A., & D.H. C/TENSOR. 195°F	6 CIL, 3.0 L
V-6, 2.8 L	1999	K050340 K060605 22440 22439 31282 31332 33936	A.A. ALT. MANGUERA INF. MANGUERA SUP. TAPON DE ACEITE TAPON DE RADIADOR TERMOSTATO	C/DH C/AA, C/DH (30 lbs) Sin Palanca 195°F	
V-6, 2.8 L	1998	K050355 K060612 31100 31847 31332 33936	A.A. ALT. TAPON DE ACEITE TAPON DE GASOLINA TAPON DE RADIADOR TERMOSTATO	C/DH C/AA, C/DH (30 lbs) Sin Palanca 195°F	

## 328IS

V-6, 2.8 L	1999	K050355 22440 22439 31100 31847 31332 33936 K060612	A.A. MANGUERA INF. MANGUERA SUP. TAPON DE ACEITE TAPON DE GASOLINA TAPON DE RADIADOR TERMOSTATO VENT, ALT Y D.H.	(30 lbs) Sin Palanca 195°F	6 CIL, 3.0 L
V-6, 2.8 L	1998	K050355 K060612 31100 31847 31332 33936	A.A. ALT. TAPON DE ACEITE TAPON DE GASOLINA TAPON DE RADIADOR TERMOSTATO	C/DH C/AA, C/DH (30 lbs) Sin Palanca 195°F	

## 330CI

V-6, 3.0 L	2006	22639 K060605 K040340 31100 31848 31332 33934	MANG. INF. SERPENTIN SERPENTIN TAPON DE ACEITE TAPON DE GASOLINA TAPON DE RADIADOR TERMOSTATO	ALT, C/BA A.A. (30 lbs) Sin Palanca 195°F	6 CIL, 3.0 L
V-6, 3.0 L	2005	22639 K060605 K040340 31100 31848 31332 33934	MANG. INF. SERPENTIN SERPENTIN TAPON DE ACEITE TAPON DE GASOLINA TAPON DE RADIADOR TERMOSTATO	ALT, C/BA A.A. (30 lbs) Sin Palanca 195°F	
V-6, 3.0 L	2004	22639 K040340 K060605 31100 31848 31332 33934	MANG. INF. SERPENTIN SERPENTIN TAPON DE ACEITE TAPON DE GASOLINA TAPON DE RADIADOR TERMOSTATO	A.A. ALTERNATOR CON B.A. (30 lbs) Sin Palanca 195°F	6 CIL, 2.5 L
6 CIL, 3.0 L	2003	22639 38069 38071 K060605 K050340 31100	MANG. INF. POLEA POLEA SERPENTIN SERPENTIN TAPON DE ACEITE	ALT, B. AGUA Y D.H. ALT, B. AGUA Y D.H. TRANSMISION DE ALT & D.H. TRANSMISION DE A.A.	

## 330XI

6 CIL, 3.0 L	2006	38018 K040340 K060605 31282 31848 31332 38069 38071 38018 K060605 K040340 31282 31848 31332 38201 38221 38069 38071 K050340 K060605 31100 31848 31332 38224 38221 38201	POLEA SERPENTIN SERPENTIN TAPON DE ACEITE TAPON DE GASOLINA TAPON DE RADIADOR POLEA POLEA POLEA SERPENTIN SERPENTIN TAPON DE ACEITE TAPON DE GASOLINA TAPON DE RADIADOR TENSOR MICRO-V TENSOR MICRO-V POLEA POLEA SERPENTIN SERPENTIN TAPON DE ACEITE TAPON DE GASOLINA TAPON DE RADIADOR TENSOR MICRO-V TENSOR MICRO-V TENSOR MICRO-V	A.A. A.A. ALT. & B.A. (30 lbs) Sin Palanca ALT, B. AGUA Y D.H. ALT, B. AGUA Y D.H. (30 lbs) Sin Palanca ALT, B. AGUA Y D.H. ALT, B. AGUA Y D.H. ALT, B. AGUA Y D.H. TRANSMISION DE A.A. TRANSMISION DE ALT & D.H. (30 lbs) Sin Palanca A.A. ALT, B. AGUA Y D.H. ALT, B. AGUA Y D.H.	
6 CIL, 3.0 L	2005	38069 38071 38018 K060605 K040340 31282 31848 31332 38201 38221 38069 38071 K050340 K060605 31100 31848 31332 38224 38221 38201	POLEA SERPENTIN SERPENTIN TAPON DE ACEITE TAPON DE GASOLINA TAPON DE RADIADOR POLEA POLEA POLEA SERPENTIN SERPENTIN TAPON DE ACEITE TAPON DE GASOLINA TAPON DE RADIADOR TENSOR MICRO-V TENSOR MICRO-V POLEA POLEA SERPENTIN SERPENTIN TAPON DE ACEITE TAPON DE GASOLINA TAPON DE RADIADOR TENSOR MICRO-V TENSOR MICRO-V TENSOR MICRO-V	(30 lbs) Sin Palanca ALT, B. AGUA Y D.H. ALT, B. AGUA Y D.H. (30 lbs) Sin Palanca ALT, B. AGUA Y D.H. ALT, B. AGUA Y D.H. ALT, B. AGUA Y D.H. TRANSMISION DE A.A. TRANSMISION DE ALT & D.H. (30 lbs) Sin Palanca A.A. ALT, B. AGUA Y D.H. ALT, B. AGUA Y D.H.	6 CIL, 3.0 L
	2001	38069 38071 K050340 K060605 31100 31848 31332 38224 38221 38201	POLEA POLEA SERPENTIN SERPENTIN TAPON DE ACEITE TAPON DE GASOLINA TAPON DE RADIADOR TENSOR MICRO-V TENSOR MICRO-V POLEA POLEA SERPENTIN SERPENTIN TAPON DE ACEITE TAPON DE GASOLINA TAPON DE RADIADOR TENSOR MICRO-V TENSOR MICRO-V	ALT, B. AGUA Y D.H. ALT, B. AGUA Y D.H. TRANSMISION DE A.A. TRANSMISION DE ALT & D.H. (30 lbs) Sin Palanca A.A. ALT, B. AGUA Y D.H. ALT, B. AGUA Y D.H.	6 CIL, 3.0 L

## 525I

6 CIL, 2.5 L	2005	22639 22638 38069 38071 K050340 K060605 31100 31332 38221 38201 33934 22639 22638 38069 38071 K060605 K050340 31100 31332 38221 38201 33934 22639 22638 38069 38071 K060605 K050340 31100 31332 38221 38201 33934	MANG. INF. MANG. SUP. POLEA POLEA SERPENTIN SERPENTIN TAPON DE ACEITE TAPON DE RADIADOR TENSOR MICRO-V TENSOR MICRO-V TERMOSTATO MANG. INF. MANG. SUP. POLEA POLEA SERPENTIN SERPENTIN TAPON DE ACEITE TAPON DE RADIADOR TENSOR MICRO-V TENSOR MICRO-V TERMOSTATO MANG. INF. MANG. SUP. POLEA POLEA SERPENTIN SERPENTIN TAPON DE ACEITE TAPON DE RADIADOR TENSOR MICRO-V TENSOR MICRO-V TERMOSTATO	ALT, B. AGUA Y D.H. ALT, B. AGUA Y D.H. A.A. ALT. & B.A. & D.H. (30 lbs) Sin Palanca ALT, B. AGUA Y D.H. ALT, B. AGUA Y D.H. ALT, B. AGUA Y D.H. 195°F ALT, B. AGUA Y D.H. ALT, B. AGUA Y D.H. A.A. ALT, B. AGUA Y D.H. ALT, B. AGUA Y D.H. ALT, B. AGUA Y D.H. ALT, B. AGUA Y D.H. ALT, B. AGUA Y D.H. ALT, B. AGUA Y D.H. ALT, B. AGUA Y D.H. ALT, B. AGUA Y D.H. A.A. (30 lbs) Sin Palanca ALT, B. AGUA Y D.H. ALT, B. AGUA Y D.H. ALT, B. AGUA Y D.H. 195°F	6 CIL, 2.5 L
--------------	------	---	--	--	--------------



6 CIL, 2.5 L	2003	22639	MANG. INF.	
		22638	MANG. SUP.	
		38071	POLEA	ALT, B. AGUA Y D.H.
		38069	POLEA	ALT, B. AGUA Y D.H.
		K050340	SERPENTIN	A.A.
		K060605	SERPENTIN	ALT., B.A., & D.H.
		31100	TAPON DE ACEITE	
		31332	TAPON DE RADIADOR	(30 lbs) Sin Palanca
		38221	SENSOR MICRO-V	ALT, B. AGUA Y D.H.
		38201	SENSOR MICRO-V	ALT, B. AGUA Y D.H.
6 CIL, 2.5 L	2002	22638	MANG. SUP.	
		38071	POLEA	ALT, B. AGUA Y D.H.
		38069	POLEA	ALT, B. AGUA Y D.H.
		K060605	SERPENTIN	ALT., B.A., & D.H.
		K050340	SERPENTIN	A.A.
		31100	TAPON DE ACEITE	
		31332	TAPON DE RADIADOR	(30 lbs) Sin Palanca
		38224	SENSOR MICRO-V	A.A.
		38221	SENSOR MICRO-V	ALT, B. AGUA Y D.H.
		38201	SENSOR MICRO-V	ALT, B. AGUA Y D.H.
6 CIL, 2.5 L	2001	22638	MANG. SUP.	
		22639	MANGUERA INF.	
		38069	POLEA	ALT, B. AGUA Y D.H.
		38071	POLEA	ALT, B. AGUA Y D.H.
		K050340	SERPENTIN	TRANSMISION DE A.A.
		K060605	SERPENTIN	TRANSMISION DE ALT & D.H.
		31282	TAPON DE ACEITE	
		31332	TAPON DE RADIADOR	(30 lbs) Sin Palanca
		38224	SENSOR MICRO-V	A.A.
		38201	SENSOR MICRO-V	ALT, B. AGUA Y D.H.

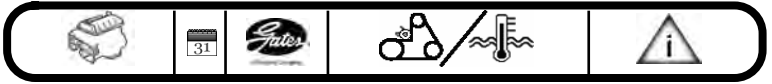

		31848	TAPON DE GASOLINA	
		31332	TAPON DE RADIADOR	(30 lbs) Sin Palanca
		38201	SENSOR MICRO-V	ALT, B. AGUA Y D.H.
		38224	SENSOR MICRO-V	
		38221	SENSOR MICRO-V	ALT, B. AGUA Y D.H.
		33934	TERMOSTATO	195°F

**5401**

V-8, 4.4 L	2001	K050395	A.A.	C/DH
		K070640	ALT.	C/AA, C/DH
		38063	POLEA	ALT, B. AGUA Y D.H.
		38066	POLEA	A.A.
		18930	SUP. - MOTOR A ALT	
		21660	SUP. - RADIADOR A MOTOR	
		31100	TAPON DE ACEITE	
		31848	TAPON DE GASOLINA	
		31332	TAPON DE RADIADOR	(30 lbs) Sin Palanca
		38219	SENSOR MICRO-V	A.A.
V-8, 4.4 L	2000	38218	SENSOR MICRO-V	ALT, Y B. AGUA
		33935	TERMOSTATO	195°F
		K050395	A.A.	C/DH
		K070640	ALT.	C/AA, C/DH
		38066	POLEA	A.A.
		38063	POLEA	ALT, B. AGUA Y D.H.
		18930	SUP. - MOTOR A ALT	
		21660	SUP. - RADIADOR A MOTOR	
		31282	TAPON DE ACEITE	
		31848	TAPON DE GASOLINA	
V-8, 4.4 L	1999	31332	TAPON DE RADIADOR	(30 lbs) Sin Palanca
		38218	SENSOR MICRO-V	ALT, B. AGUA Y D.H.
		38219	SENSOR MICRO-V	A.A.
		33935	TERMOSTATO	195°F
		K050395	A.A.	C/DH
		K070640	ALT.	C/AA, C/DH
		38063	POLEA	ALT, B. AGUA Y D.H.
		38066	POLEA	A.A.
		18930	SUP. - MOTOR A ALT	
		21660	SUP. - RADIADOR A MOTOR	

**5281**

V-6, 2.8 L	2000	K050340	A.A.	C/DH
		K060605	ALT.	C/AA, C/DH
		22638	MANG. SUP.	
		22639	MANGUERA INF.	
		31282	TAPON DE ACEITE	
		31848	TAPON DE GASOLINA	
		31332	TAPON DE RADIADOR	(30 lbs) Sin Palanca
		38224	SENSOR MICRO-V	A.A.
		38201	SENSOR MICRO-V	ALT., B.A., & D.H. C/SENSOR.
		V-6, 2.8 L	1999	K050340
K060605	ALT.			C/AA, C/DH
22637	MANGUERA INF.			
22439	MANGUERA SUP.			
31100	TAPON DE ACEITE			
31847	TAPON DE GASOLINA			
31332	TAPON DE RADIADOR			(30 lbs) Sin Palanca
38224	SENSOR MICRO-V			A.A.
38201	SENSOR MICRO-V			ALT., B.A., & D.H. C/SENSOR.
33934	TERMOSTATO			195°F
V-6, 2.8 L	1998	K050355	A.A.	C/DH
		K060612	ALT.	C/AA, C/DH
		22637	MANG. INF.	
		22439	MANG. SUP.	
		31100	TAPON DE ACEITE	
		31847	TAPON DE GASOLINA	
		31332	TAPON DE RADIADOR	(30 lbs) Sin Palanca
		38201	SENSOR MICRO-V	ALT., B.A., & D.H. C/SENSOR.
		33936	TERMOSTATO	195°F

**5451**

V-8, 4.4 L	2005	38018	POLEA TENSORA	A.A.
		K040322	SERPENTIN	
		K060609	SERPENTIN	
		31100	TAPON DE ACEITE	
		31848	TAPON DE GASOLINA	
		33934	TERMOSTATO	195°F
		K060609	SERPENTIN	ALT., B.A., & D.H.
		K040322	SERPENTIN	A.A.
		31100	TAPON DE ACEITE	
		31848	TAPON DE GASOLINA	
V-8, 4.4 L	2004	31332	TAPON DE RADIADOR	(30 lbs) Sin Palanca
		33934	TERMOSTATO	195°F

**5301**

6 CIL, 3.0 L	2002	22639	MANG. INF.	
		22638	MANG. SUP.	
		38069	POLEA	ALT, B. AGUA Y D.H.
		38071	POLEA	ALT, B. AGUA Y D.H.
		38018	POLEA TENSORA	A.A.
		K070622	SERPENTIN	TRANSMISION DE ALTERNAT
		K050340	SERPENTIN	A.A.
		31100	TAPON DE ACEITE	

**5501**

V-8, 4.4 L	2006	K040322	SERPENTIN	A.A.
		K060609	SERPENTIN	



<b>645CI</b>			
V-8, 4.4 L	2005	K040322 K060609 31282 31848	SERPENTIN SERPENTIN TAPON DE ACEITE TAPON DE GASOLINA

<b>6501</b>			
V-8, 4.4 L	2006	K060609 K040322	SERPENTIN SERPENTIN
			ALT. B.A. & D.H. A.A.

<b>740I</b>			
V-8, 4.4 L	2001	K050395 K050396 K070640 38066 38063 18930 21660 31100 31847 31332 38219 38218 33935	A.A. A.A. ALT. POLEA POLEA SUP. - MOTOR A ALT SUP. - RADIADOR A MOTOR TAPON DE ACEITE TAPON DE GASOLINA TAPON DE RADIADOR TENSOR MICRO-V TENSOR MICRO-V TERMOSTATO
			C/DH C/AA, C/DH A.A. ALT, B. AGUA Y D.H.
V-8, 4.4 L	2000	K050395 K050396 K070640 38066 38063 18930 21660 31100 31332 38218 38219 33935	A.A. A.A. ALT. POLEA POLEA SUP. - MOTOR A ALT SUP. - RADIADOR A MOTOR TAPON DE ACEITE TAPON DE GASOLINA TAPON DE RADIADOR TENSOR MICRO-V TENSOR MICRO-V TERMOSTATO
			C/DH C/AA, C/DH A.A. ALT, B. AGUA Y D.H.
V-8, 4.4 L	1999	K050395 K070640 38063 38066 18930 21660 31100 31332 38219 38218 33935	A.A. ALT. POLEA POLEA SUP. - MOTOR A ALT SUP. - RADIADOR A MOTOR TAPON DE ACEITE TAPON DE GASOLINA TAPON DE RADIADOR TENSOR MICRO-V TENSOR MICRO-V TERMOSTATO
			(30 lbs) Sin Palanca A.A. ALT, B. AGUA Y D.H. 195°F C/DH C/AA, C/DH ALT, B. AGUA Y D.H. A.A.
V-8, 4.4 L	1998	K050395 K070640 38063 38066 31100 31847 31332 38219 38218 33935	A.A. ALT. POLEA POLEA TAPON DE ACEITE TAPON DE GASOLINA TAPON DE RADIADOR TENSOR MICRO-V TENSOR MICRO-V TERMOSTATO
			C/DH C/AA, C/DH ALT, B. AGUA Y D.H. A.A. (30 lbs) Sin Palanca A.A. ALT, B. AGUA Y D.H. 195°F

<b>740IIL</b>			
V-8, 4.4 L	2001	K050396 K070640 38066 38063 18930 21660 31100 31847 31332 38218 38219	A.A. ALT. POLEA POLEA SUP. - MOTOR A ALT SUP. - RADIADOR A MOTOR TAPON DE ACEITE TAPON DE GASOLINA TAPON DE RADIADOR TENSOR MICRO-V TENSOR MICRO-V
			A.A. ALT, B. AGUA Y D.H.
			(30 lbs) Sin Palanca ALT, B. AGUA Y D.H. A.A.

V-8, 4.4 L	2000	33935 K050396 K070640 38066 38063 18930 21660 31282 31847 31332 38218 38219 33935	TERMOSTATO A.A. ALT. POLEA POLEA SUP. - MOTOR A ALT SUP. - RADIADOR A MOTOR TAPON DE ACEITE TAPON DE GASOLINA TAPON DE RADIADOR TENSOR MICRO-V TENSOR MICRO-V TERMOSTATO
			195°F A.A. ALT, B. AGUA Y D.H.
V-8, 4.4 L	1999	K050396 K070640 38063 38066 18930 21660 31100 31332 38218 38219 33935	A.A. ALT. POLEA POLEA SUP. - MOTOR A ALT SUP. - RADIADOR A MOTOR TAPON DE ACEITE TAPON DE RADIADOR TENSOR MICRO-V TENSOR MICRO-V TERMOSTATO
			(30 lbs) Sin Palanca ALT, B. AGUA Y D.H. A.A. 195°F
V-8, 4.4 L	1998	K050395 K070640 38066 38063 31847 31332 38219 38218 33935	A.A. ALT. POLEA POLEA TAPON DE GASOLINA TAPON DE RADIADOR TENSOR MICRO-V TENSOR MICRO-V TERMOSTATO
			(30 lbs) Sin Palanca A.A. ALT, B. AGUA Y D.H. 195°F

<b>745I</b>			
V-8, 4.4 L	2005	38063 K040322 K060609 31282 31848 31332	POLEA SERPENTIN SERPENTIN TAPON DE ACEITE TAPON DE GASOLINA TAPON DE RADIADOR
			ALT, B. AGUA Y D.H. (30 lbs) Sin Palanca
V-8, 4.4 L	2004	K060609 K040322 31100 31332	SERPENTIN SERPENTIN TAPON DE ACEITE TAPON DE RADIADOR
			ALT., B.A., & D.H. A.A. (30 lbs) Sin Palanca
V-8, 4.4 L	2003	K040322 K060609 31100 31332	SERPENTIN SERPENTIN TAPON DE ACEITE TAPON DE RADIADOR
			A.A. (30 lbs) Sin Palanca

<b>745LI</b>			
V-8, 4.4 L	2005	38063 K040322 K060609 31282 31848 31332	POLEA SERPENTIN SERPENTIN TAPON DE ACEITE TAPON DE GASOLINA TAPON DE RADIADOR
			ALT, B. AGUA Y D.H. (30 lbs) Sin Palanca

<b>750IIL</b>			
V-12, 5.4 L	2001	22637 K060468 31100 31332	MANGUERA INF. SERPENTIN TAPON DE ACEITE TAPON DE RADIADOR
			(30 lbs) Sin Palanca
V-12, 5.4 L	2000	22637 38062 38061 K060465 31100 31332	MANGUERA INF. POLEA POLEA SERPENTIN TAPON DE ACEITE TAPON DE RADIADOR
			ALT. Y D.H. VENTILADOR Y A.A. TRANSMISION DE A.A. (30 lbs) Sin Palanca C/AA, C/DH
V-12, 5.4 L	1999	K060465 22637 38062 38061	ALT. MANGUERA INF. POLEA POLEA
			(30 lbs) Sin Palanca ALT. Y D.H. VENTILADOR Y A.A.

V-12, 5.4 L	1999	31100 31332	TAPON DE ACEITE TAPON DE RADIADOR	(30 lbs) Sin Palanca
V-12, 5.4 L	1998	K060465 22637 38062 38061 31100 31332	ALT. MANG. INF. POLEA POLEA TAPON DE ACEITE TAPON DE RADIADOR	C/AA, C/DH ALT. Y D.H. B. AGUA Y A.A. (30 lbs) Sin Palanca

V-8, 5.0 L	2000	31282 31332 38219 38218 K070640 K050385 31282 31332 38219 38218	TAPON DE ACEITE TAPON DE RADIADOR TENSOR MICRO-V TENSOR MICRO-V SERPENTIN SERPENTIN TAPON DE ACEITE TAPON DE RADIADOR TENSOR MICRO-V TENSOR MICRO-V	(30 lbs) Sin Palanca A.A. ALT. Y B. AGUA TRANSMISION DE ALT & D.H. TRANSMISION DE A.A. (30 lbs) Sin Palanca A.A. ALT, B. AGUA Y D.H.

**760I**

V-12, 6.0 L	2005	38063 K040322 K060609 31282 31332	POLEA SERPENTIN SERPENTIN TAPON DE ACEITE TAPON DE RADIADOR	ALT, B. AGUA Y D.H. (30 lbs) Sin Palanca
-------------	------	---	---	---

**X3**

V-6, 3.0 L	2008	38018 K060785 31332	POLEA SERPENTIN TAPONES DE RADIADOR	30 LBS.
V-6, 3.0 L	2007	38018 K060785 31332	POLEA SERPENTIN TAPONES DE RADIADOR	30 LBS.
6 CIL, 3.0 L	2006	38071 38018 38069 K040340 K060605 31282 31332 38201 38221 38384 33934	POLEA POLEA POLEA SERPENTIN SERPENTIN TAPON DE ACEITE TAPON DE RADIADOR TENSOR MICRO-V TENSOR MICRO-V TENSOR MICRO-V TERMOSTATO	ALT, B. AGUA Y D.H. ALT, B. AGUA Y D.H. A.A. ALT. & B.A. & D.H. (30 lbs) Sin Palanca ALT, B. AGUA Y D.H. ALT, B. AGUA Y D.H. 195°F
6 CIL, 3.0 L	2005	38071 38069 38018 K060605 K040340 31282 31332 38384 38221 38201 33934	POLEA POLEA POLEA SERPENTIN SERPENTIN TAPON DE ACEITE TAPON DE RADIADOR TENSOR MICRO-V TENSOR MICRO-V TENSOR MICRO-V TERMOSTATO	ALT, B. AGUA Y D.H. ALT, B. AGUA Y D.H. (30 lbs) Sin Palanca ALT, B. AGUA Y D.H. ALT, B. AGUA Y D.H. 195°F

**760LI**

V-12, 6.0 L	2005	38063 K040322 K060609 31282 31332	POLEA SERPENTIN SERPENTIN TAPON DE ACEITE TAPON DE RADIADOR	ALT, B. AGUA Y D.H. (30 lbs) Sin Palanca
V-12, 6.0 L	2004	K040322 K060609 31100 31332	SERPENTIN SERPENTIN TAPON DE ACEITE TAPON DE RADIADOR	A.A. ALT., B.A., & D.H. (30 lbs) Sin Palanca

**M**

V-6, 3.2 L	2000	K060612 K050355	SERPENTIN SERPENTIN	TRANSMISION DE ALT & D.H. TRANSMISION DE A.A.
V-6, 3.2 L	1999	K050355 K060612 22440 22439	A.A. ALT. MANGUERA INF. MANGUERA SUP.	C/DH C/AA, C/DH

**M3**

V-6, 3.2 L	2006	K060578 31100 31332	SERPENTIN TAPON DE ACEITE TAPON DE RADIADOR	ALT. C/BA (30 lbs) Sin Palanca
V-6, 3.2 L	2005	K060578 31100 31332	SERPENTIN TAPON DE ACEITE TAPON DE RADIADOR	ALT. C/BA (30 lbs) Sin Palanca
V-6, 3.2 L	2004	K060578 31100 31332	SERPENTIN TAPON DE ACEITE TAPON DE RADIADOR	ALTERNADOR CON B.A. (30 lbs) Sin Palanca
6 CIL, 3.2 L	2002	38071 38069 38224 38221	POLEA POLEA TENSOR MICRO-V TENSOR MICRO-V	ALT, B. AGUA Y D.H. ALT, B. AGUA Y D.H. A.A. ALT, B. AGUA Y D.H.
6 CIL, 3.2 L	2001	38071 38069 38224 38201 38221	POLEA POLEA TENSOR MICRO-V TENSOR MICRO-V TENSOR MICRO-V	ALT, B. AGUA Y D.H. ALT, B. AGUA Y D.H. A.A. ALT, B. AGUA Y D.H. ALT, B. AGUA Y D.H.
V-6, 3.2 L	1999	K050355 K060612 22440 22439 31100 31332	A.A. ALT. MANGUERA INF. MANGUERA SUP. TAPON DE ACEITE TAPON DE RADIADOR	C/DH C/AA, C/DH (30 lbs) Sin Palanca

**X5**

V-6, 3.0 L	2009	38018 K060785 31103 31848	POLEA SERPENTIN TAPON DE ACEITE TAPON DE GASOLINA	
V-6, 3.0 L	2008	K070539 31103 31848	SERPENTIN TAPON DE ACEITE TAPON DE GASOLINA	
V-6, 3.0 L	2007	K070539 31103 31848	SERPENTIN TAPON DE ACEITE TAPON DE GASOLINA	
6 CIL, 3.0 L	2006	38018 38071 K040340 K060605 31282 31332 38201 38384 38221 33934	POLEA POLEA LOCA SERPENTIN SERPENTIN TAPON DE ACEITE TAPON DE RADIADOR TENSOR MICRO-V TENSOR MICRO-V TENSOR MICRO-V TERMOSTATO	A.A. ALT. C/TENSOR HIDR. A.A. ALT. & B.A. & D.H. (30 lbs) Sin Palanca ALT. & B.A.
6 CIL, 3.0 L	2005	38071 38069 38018 K040340 K060605 31282 31332 38201 38384 38221 33934	POLEA POLEA POLEA SERPENTIN SERPENTIN TAPON DE ACEITE TAPON DE RADIADOR TENSOR MICRO-V TENSOR MICRO-V TENSOR MICRO-V TERMOSTATO	ALT, B. AGUA Y D.H. ALT, B. AGUA Y D.H. A.A. ALT. & B.A. & D.H. (30 lbs) Sin Palanca ALT. & B.A. C/TENSOR HIDR. 195°F LOCA ALT, B. AGUA Y D.H.
V-6, 3.0 L	2004	K040340	SERPENTIN	A.A.

**M5**

V-8, 5.0 L	2003	K070640 K050385 31100 31332	SERPENTIN SERPENTIN TAPON DE ACEITE TAPON DE RADIADOR	ALT., B.A., & D.H. A.A. (30 lbs) Sin Palanca
V-8, 5.0 L	2002	K070640 K050385 31282 31332	SERPENTIN SERPENTIN TAPON DE ACEITE TAPON DE RADIADOR	ALT., B.A., & D.H. A.A. (30 lbs) Sin Palanca
V-8, 5.0 L	2001	K070640 K050385	SERPENTIN SERPENTIN	ALT., B.A., & D.H. A.A.



V-6, 3.0 L	2004	K060605 31100 31332 38221 38201 33934	SERPENTIN TAPON DE ACEITE TAPON DE RADIADOR TENSOR MICRO-V TENSOR MICRO-V TERMOSTATO	ALTERNADOR CON B.A.  (30 lbs) Sin Palanca ALT Y B.A. C/TENSOR HIDRA6 CIL., 2.8 L ALT Y B.A. C/TENSOR AUTOM 195°F			K060682 38070 38223 38069 38071 38221 38201 38220 38071 38069 38070 38221	ALT. POLEA TENSOR MICRO-V POLEA POLEA TENSOR MICRO-V TENSOR MICRO-V TENSOR MICRO-V POLEA POLEA TENSOR MICRO-V	A.A. ALT, B. AGUA Y D.H. ALT, B. AGUA Y D.H. ALT, B. AGUA Y D.H. ALT, B. AGUA Y D.H. ALT, B. AGUA Y D.H. A.A. ALT, B. AGUA Y D.H. ALT, B. AGUA Y D.H. A.A. Y A.P. ALT, B. AGUA Y D.H.
V-8, 4.4 L	2004	K040338 31100 31332 33935	SERPENTIN TAPON DE ACEITE TAPON DE RADIADOR TERMOSTATO	(30 lbs) Sin Palanca 195°F	6 CIL., 3.2 L	1998	K050355 K060612	POLEA POLEA	ALT, B. AGUA Y D.H. ALT, B. AGUA Y D.H.
V-6, 3.0 L	2002	31100 31332	TAPON DE ACEITE TAPON DE RADIADOR	(30 lbs) Sin Palanca				POLEA TENSOR MICRO-V	ALT, B. AGUA Y D.H. A.A.
V-8, 4.6 L	2002	38018 38063 38219 38218	POLEA POLEA TENSOR MICRO-V TENSOR MICRO-V	A.A. ALT, B. AGUA Y D.H. A.A.	V-6, 2.8 L	1998		POLEA TENSOR MICRO-V	ALT, B. AGUA Y D.H. A.A.
V-6, 3.0 L	2001	31100 31332	TAPON DE ACEITE TAPON DE RADIADOR	(30 lbs) Sin Palanca					
6 CIL., 3.0 L	2000	31332	TAPON DE RADIADOR	(30 lbs) Sin Palanca					
V-8, 4.4 L	2000	K050396 38018 38063 31100 31332 38218 38219 33935 K070640	A.A. POLEA POLEA TAPON DE ACEITE TAPON DE RADIADOR TENSOR MICRO-V TENSOR MICRO-V TERMOSTATO VENT & ALT	A.A. ALT, B. AGUA Y D.H.  (30 lbs) Sin Palanca ALT, B. AGUA Y D.H. A.A. 195°F	6 CIL., 2.5 L  6 CIL., 3.0 L	2005			

**Z3**

V-6, 2.5 L	2001	22639 22439 K060605 K050340 31100 31332 33934	MANGUERA INF. MANGUERA SUP. SERPENTIN SERPENTIN TAPON DE ACEITE TAPON DE RADIADOR TERMOSTATO	TRANSMISION DE ALT & D.H. TRANSMISION DE A.A.  (30 lbs) Sin Palanca 195°F	V-6, 2.5 L	
V-6, 3.0 L	2001	22639 22439 K050340 K060605 31100 31332 33934	MANGUERA INF. MANGUERA SUP. SERPENTIN SERPENTIN TAPON DE ACEITE TAPON DE RADIADOR TERMOSTATO	TRANSMISION DE A.A. TRANSMISION DE ALT & D.H.V-6, 3.0 L  (30 lbs) Sin Palanca 195°F		
V-6, 2.5 L	2000	K050355 K060612 K060605 22639 22439 31282 31100 31332 33934	A.A. ALT. BA, ALT. Y D.H. MANGUERA INF. MANGUERA SUP. TAPON DE ACEITE TAPON DE ACEITE TAPON DE RADIADOR TERMOSTATO	C/DH C/AA, C/DH     (30 lbs) Sin Palanca 195°F	6 CIL., 2.5 L	
V-6, 2.8 L	2000	K050355 22639 22439 31282 31100 31332 33934 K060612	A.A. MANGUERA INF. MANGUERA SUP. TAPON DE ACEITE TAPON DE ACEITE TAPON DE RADIADOR TERMOSTATO VENT, ALT Y D.H.		6 CIL., 3.0 L	
V-6, 3.0 L	2000	31100	TAPON DE ACEITE			
V-6, 2.5 L	1999	K050355 K060612 22440 22639 31282 31332	A.A. ALT. MANGUERA INF. MANGUERA INF. TAPON DE ACEITE TAPON DE RADIADOR	C/DH C/AA, C/DH    (30 lbs) Sin Palanca		
V-6, 2.8 L	1999	K050355 K060612 31100 31332	A.A. ALT. TAPON DE ACEITE TAPON DE RADIADOR			
V-6, 3.0 L	1999	31100	TAPON DE ACEITE			
4 CIL., 1.9 L	1998	K040350	A.A.			

**Z4**

V-6, 2.5 L	2006	K060573 K040340 31100 31332 38201 33934	SERPENTIN SERPENTIN TAPON DE ACEITE TAPON DE RADIADOR TENSOR MICRO-V TERMOSTATO			
	2005	38008 38069 38201 38008 38069 38201	POLEA POLEA TENSOR MICRO-V POLEA POLEA TENSOR MICRO-V		6 CIL., 2.5 L	
	2005	38008 38069 38201	POLEA POLEA TENSOR MICRO-V		6 CIL., 3.0 L	
V-6, 2.5 L	2005	K040340 K060573 31100 31332 38201 33934	SERPENTIN SERPENTIN TAPON DE ACEITE TAPON DE RADIADOR TENSOR MICRO-V TERMOSTATO	TRANSMISION DE ALT & D.H. TRANSMISION DE A.A.  (30 lbs) Sin Palanca 195°F	V-6, 2.5 L	
	2004	K040340 K060573 31100 31332 38201 33934	SERPENTIN SERPENTIN TAPON DE ACEITE TAPON DE RADIADOR TENSOR MICRO-V TERMOSTATO			
	2004	K040340 K060573 31100 31332 38201 33934	SERPENTIN SERPENTIN TAPON DE ACEITE TAPON DE RADIADOR TENSOR MICRO-V TERMOSTATO			
	2003	38008 38069 K040340 K060573 31100 31332 38201 33934	POLEA POLEA SERPENTIN SERPENTIN TAPON DE ACEITE TAPON DE RADIADOR TENSOR MICRO-V TERMOSTATO		6 CIL., 2.5 L	
	2003	38008 38069 K060573 K040340 31100 31332 38201 33934	POLEA POLEA SERPENTIN SERPENTIN TAPON DE ACEITE TAPON DE RADIADOR TENSOR MICRO-V TERMOSTATO			

**BUICK**

**ENCLAVE**

V-6, 3.6 L	2010	23294 23293 K060938 31103 31843	MANGUERA INF. MANGUERA SUP. SERPENTIN TAPON DE ACEITE TAPON DE GASOLINA			
------------	------	---	---	--	--	--

V-6, 3.6 L	2010	31844 31532 38397	TAPON DE GASOLINA TAPONES DE RADIADOR TENSOR	CON LLAVE 15 LBS.

**LACROSSE**

V-6, 3.6 L	2010	K060956 38397	SERPENTIN TENSOR	
------------	------	------------------	---------------------	--

V-6, 3.2 L

2004

22911	MANGUERA SUP.	
31103	TAPON DE ACEITE	
31532	TAPON DE RADIADOR	(15 lbs) Sin palanca
K060473	TRANSMISION DE ACCESORIOS	D.H. & A.A
K060468	TRANSMISION DE ACCESORIOS	ALT & B.A.
22723	MANGUERA INF.	
22722	MANGUERA SUP.	
38009	POLEA	
K060870	SERPENTIN	
31103	TAPON DE ACEITE	
31636	TAPON DE GASOLINA	SIN LLAVE REGULAR
31532	TAPON DE RADIADOR	(15 lbs) Sin palanca
38179	TENSOR MICRO-V	
T285	BANDA ARBOL DE LEVAS	
18718	CALEF. A MOTOR	
38009	POLEA DEL TENSOR	
K060870	SERPENTIN	
31103	TAPON DE ACEITE	
31636	TAPON DE GASOLINA	SIN LLAVE REGULAR
31532	TAPON DE RADIADOR	(15 lbs) Sin palanca
38179	TENSOR MICRO-V	

**CADILLAC**

**CATERA**

V-6, 3.0 L	2001	T285 TCK285A 22379 22378 19698 19700 38009 K060795 31291 31546 38179	BANDA ARBOL DE LEVAS KIT DE DISTRIBUCION MANGUERA INF. MANGUERA SUP. PASO - ENTRADA A BA PASO - SALIDA DE BA POLEA DEL TENSOR SERPENTIN TAPON DE ACEITE TAPON DE RADIADOR TENSOR MICRO-V	(15 lbs) Sin Palanca
V-6, 3.0 L	2000	T285 TCK285A 19700 19698 22379 22378 38009 K060795 31291 31546 38179	BANDA ARBOL DE LEVAS KIT DE DISTRIBUCION MANGUERA DE CALEF. MANGUERA DE PASO MANGUERA INF. MANGUERA SUP. POLEA DEL TENSOR SERPENTIN TAPON DE ACEITE TAPON DE RADIADOR TENSOR MICRO-V	(15 lbs) Sin Palanca
V-6, 3.0 L	1999	T285 TCK285 TCK285A 19700 19698 22379 22378 38009 K060795 31291 31546 38179	BANDA ARBOL DE LEVAS KIT DE DISTRIBUCION KIT DE DISTRIBUCION MANGUERA DE CALEF. MANGUERA DE PASO MANGUERA INF. MANGUERA SUP. POLEA DEL TENSOR SERPENTIN TAPON DE ACEITE TAPON DE RADIADOR TENSOR MICRO-V	(15 lbs) Sin Palanca
V-6, 3.0 L	1998	T285 TCK285 19700 19698 22379 22378 38009 K060795 31291 31546 38179	BANDA ARBOL DE LEVAS KIT DE DISTRIBUCION MANGUERA DE CALEF. MANGUERA DE PASO MANGUERA INF. MANGUERA SUP. POLEA DEL TENSOR SERPENTIN TAPON DE ACEITE TAPON DE RADIADOR TENSOR MICRO-V	(15 lbs) Sin Palanca

**DEVILLE**

V-8, 4.6 L	2005	20294 22525 38025 38006 38041 K060815 K030245 31103 31636 31525 38153 38197 33808	MANG. INF. MANG. SUP. POLEA POLEA POLEA LOCA SERPENTIN SERPENTIN TAPON DE ACEITE TAPON DE GASOLINA TAPON DE RADIADOR TENSOR MICRO-V TENSOR MICRO-V TERMOSTATO	CORTAR A MEDIDA  P/BA SERPENTIN  P/BA  SIN LLAVE REGULAR (18 lbs) Sin Palanca SERPENTIN P/BA 180°F
V-8, 4.6 L	2004	20294 22525 38025 38006 38041 K060815 K030245 31103 31782 31525 38153 38197 33808	MANGUERA INF. MANGUERA SUP. POLEA POLEA POLEA LOCA SERPENTIN SERPENTIN TAPON DE ACEITE TAPON DE GASOLINA TAPON DE RADIADOR TENSOR MICRO-V TENSOR MICRO-V TERMOSTATO	B.A. SERPENTIN  B.A.  CON LLAVE REGULAR (18 lbs) Sin Palanca SERPENTIN B.A. 180°F
V-8, 4.6 L	2003	19658 20294 22525 38025 38006 38041 K060815 K030245 18230 31103 31636 31525 38153 38197 33808	CALEF. A TUBO-1 MANGUERA INF. MANGUERA SUP. POLEA DEL TENSOR POLEA DEL TENSOR POLEA LOCA SERPENTIN SERPENTIN B.A. TANQUE DE RECUPERACION A	B.A. SERPENTIN  B.A. SERPENTIN  SIN LLAVE REGULAR (18 lbs) Sin Palanca Serpentin B. AGUA 180°F
V-8, 4.6 L	2002	19658 20294 38041	CALEF. A TUBO-1 MANGUERA INF. POLEA	

**CTS**

V-6, 3.6 L	2007	23028 K060468 K060473 38418 38419	MANG. SUP. SERPENTIN SERPENTIN TENSOR MICRO-V TENSOR MICRO-V	B.A. / ALT. D.H. /AA B.A. A.A.
V-6, 3.6 L	2006	22912 22911 K060473 K060870 K060468 31103 31532	MANG. INF. MANG. SUP. SERPENTIN SERPENTIN SERPENTIN TAPON DE ACEITE TAPON DE RADIADOR	D.H. & A.A  ALT. & B.A. (15 lbs) Sin palanca
V-6, 3.6 L	2005	22912	MANGUERA INF.	



V-8, 4.6 L	2002	38025	POLEA DEL TENSOR	B.A.
		38006	POLEA DEL TENSOR	SERPENTIN
		K060815	SERPENTIN	
		K030245	SERPENTIN B.A.	
		18230	TANQUE DE RECUPERACION A	
		31103	TAPON DE ACEITE	
		31636	TAPON DE GASOLINA	SIN LLAVE REGULAR
		31782	TAPON DE GASOLINA	CON LLAVE REGULAR
		31525	TAPON DE RADIADOR	(18 lbs) Sin Palanca
		38153	SENSOR MICRO-V	Serpentin
		38197	SENSOR MICRO-V	B. AGUA
		33808	TERMOSTATO	180°F
		30T 3/4"	TERMOSTATO A TUBO-3	
		19717	TUBO-1 A TUBO-2	
		19279	TUBO-4 A TUBO-5	
V-8, 4.6 L	2001	19035	TUBO-6 A TOMA DE AGUA	
		19658	CALEF. A TUBO-1	
		20294	MANGUERA INF.	
		38041	POLEA	
		38006	POLEA	SERPENTIN
		38025	POLEA DEL TENSOR - BA	
		K060815	SERPENTIN	
		K030245	SERPENTIN B.A.	
		31103	TAPON DE ACEITE	
		31782	TAPON DE GASOLINA	CON LLAVE REGULAR
		31525	TAPON DE RADIADOR	(18 lbs) Sin Palanca
		38153	SENSOR MICRO-V	B. AGUA
		38197	SENSOR MICRO-V	180°F
		33808	TERMOSTATO	C/AA, C/DH
		V-8, 4.6 L	2000	19658
20294	MANGUERA INF.			C/AA, C/DH
22080	MANGUERA SUP.			
38041	POLEA			SERPENTIN
38006	POLEA			
38025	POLEA DEL TENSOR - BA			
K060815	SERPENTIN			
K030245	SERPENTIN B.A.			
31103	TAPON DE ACEITE			
31636	TAPON DE GASOLINA			SIN LLAVE REGULAR
31782	TAPON DE GASOLINA			CON LLAVE REGULAR
31525	TAPON DE RADIADOR			(18 lbs) Sin Palanca
38153	SENSOR MICRO-V			B. AGUA
38197	SENSOR MICRO-V			180°F
V-8, 4.6 L	1999			19087
		19658	CALEF. A TUBO-2	
		22079	MANGUERA INF.	
		20294	MANGUERA INF.	C/AA, C/DH
		22080	MANGUERA SUP.	C/AA, C/DH
		38006	POLEA	SERPENTIN
		38041	POLEA	
		38025	POLEA DEL TENSOR - BA	
		K060825	SERPENTIN	
		K030245	SERPENTIN B.A.	
		31103	TAPON DE ACEITE	
		31636	TAPON DE GASOLINA	SIN LLAVE REGULAR
		31782	TAPON DE GASOLINA	CON LLAVE REGULAR
		31525	TAPON DE RADIADOR	(18 lbs) Sin Palanca
		38153	SENSOR MICRO-V	B. AGUA
38197	SENSOR MICRO-V	180°F		
V-8, 4.6 L	1998	19088	TUBO-1 A MOTOR	
		19714	TUBO-2 A MOTOR	
		20294	MANGUERA INF.	C/AA, C/DH
		22080	MANGUERA SUP.	C/AA, C/DH
		38006	POLEA	SERPENTIN
		38041	POLEA	
		38025	POLEA	B. AGUA
		K060825	SERPENTIN	
		31103	TAPON DE ACEITE	
		31636	TAPON DE GASOLINA	SIN LLAVE REGULAR
		31782	TAPON DE GASOLINA	CON LLAVE REGULAR
		31525	TAPON DE RADIADOR	(18 lbs) Sin Palanca
		38153	SENSOR MICRO-V	ACCESORIO
		38197	SENSOR MICRO-V	B. AGUA











V-8, 4.6 L	1997	33808	TERMOSTATO	180°F
		20294	MANGUERA INF.	C/AA, C/DH
		22080	MANGUERA SUP.	C/AA, C/DH
		K060825	SERPENTIN	
		31103	TAPON DE ACEITE	
		31636	TAPON DE GASOLINA	SIN LLAVE REGULAR
		31525	TAPON DE RADIADOR	(18 lbs) Sin Palanca
		33808	TERMOSTATO	180°F

**DTS**

V-8, 4.6 L	2007	38041	POLEA	SERPENTIN
		38025	POLEA	B. AGUA
		38006	POLEA	SERPENTIN
		38153	SENSOR MICRO-V	ACCESORIO
		38197	SENSOR MICRO-V	B. AGUA
V-8, 4.6 L	2006	38041	POLEA	
		38025	POLEA	B. AGUA
		38006	POLEA	SERPENTIN
		38153	SENSOR MICRO-V	ACCESORIO
		38197	SENSOR MICRO-V	B. AGUA

**EL DORADO**

V-8, 4.6 L	2002	19734	MANG. CALEF. A TUBO-1	
		22079	MANG. INF.	CORTAR A MEDIDA
		22080	MANG. SUP.	
		38041	POLEA	
		38025	POLEA	B.A.
		38006	POLEA	SERPENTIN
		K030245	SERPENTIN	B.A.
		K060825	SERPENTIN	
		31103	TAPON DE ACEITE	
		31782	TAPON DE GASOLINA	CON LLAVE REGULAR
		31535	TAPON DE RADIADOR	(18 lbs) Con Palanca
		38153	SENSOR MICRO-V	
		38197	SENSOR MICRO-V	B. AGUA
		19734	MANG. CALEF. A TUBO-1	
		22079	MANG. INF.	CORTAR A MEDIDA
22080	MANG. SUP.			
38041	POLEA			
38006	POLEA			
38025	POLEA LOCA			
K030245	SERPENTIN	B.A.		
K060825	SERPENTIN			
31103	TAPON DE ACEITE			
31782	TAPON DE GASOLINA	CON LLAVE REGULAR		
31535	TAPON DE RADIADOR	(18 lbs) Con Palanca		
38153	SENSOR MICRO-V			
38197	SENSOR MICRO-V	B. AGUA		
19734	MANG. CALEF. A TUBO-1			
22079	MANG. INF.	CORTAR A MEDIDA		
22080	MANG. SUP.			
38041	POLEA			
38006	POLEA			
38025	POLEA LOCA			
K060825	SERPENTIN			
K030245	SERPENTIN	B.A.		
31103	TAPON DE ACEITE			
31636	TAPON DE GASOLINA	SIN LLAVE REGULAR		
31535	TAPON DE RADIADOR	(18 lbs) Con Palanca		
38153	SENSOR MICRO-V			
38197	SENSOR MICRO-V	B. AGUA		
33808	TERMOSTATO	180°F		
19088	MANG. A TUBO-1 A MOTOR			
19714	MANG. A TUBO-2 A MOTOR			
19087	MANG. CALEF. A TUBO-1			
19658	MANG. CALEF. A TUBO-2	CORTAR A MEDIDA		
22080	MANG. SUP.			
22079	MANGUERA INF.			
38006	POLEA			
38041	POLEA			
38025	POLEA LOCA			
K060825	SERPENTIN			
K030245	SERPENTIN B.A.			
31103	TAPON DE ACEITE			

    				    					
V-8, 4.6 L	1999	31782 31535 38153 38197 33808	TAPON DE GASOLINA TAPON DE RADIADOR TENSOR MICRO-V TENSOR MICRO-V TERMOSTATO	CON LLAVE REGULAR (18 lbs) Con Palanca  B. AGUA 180°F		K060935 K040378 31103 31843 31532 38158 38159	SERPENTIN SERPENTIN TAPON DE ACEITE TAPON DE GASOLINA TAPON DE RADIADOR TENSOR MICRO-V TENSOR MICRO-V	A.A.  SIN LLAVE REGULAR (15 lbs) Sin palanca SERPENTIN A.A.	
V-8, 4.6 L	1998	22079 38041 38006 38025 K060825 K030245 31636 38153 38197	MANGUERA INF. POLEA POLEA LOCA POLEA LOCA SERPENTIN SERPENTIN B.A. TAPON DE GASOLINA TENSOR MICRO-V TENSOR MICRO-V		V-8, 6.0 L	2006	22437 22436 38009 38001 K060923 K060930 K040378	MANG. INF. MANG. SUP. POLEA POLEA LOCA SERPENTIN SERPENTIN SERPENTIN	SERPENTIN SERPENTIN C/ALT 105A C/ALT. 145A A.A.
V-8, 4.6 L	1997	22079 38006 38001 38025 K030245 K060825 31103 31636 31535 38153 33808	MANGUERA INF. POLEA POLEA LOCA POLEA LOCA SERPENTIN SERPENTIN TAPON DE ACEITE TAPON DE GASOLINA TAPON DE RADIADOR TENSOR MICRO-V TERMOSTATO	SIN LLAVE REGULAR ACCESORIO B. AGUA  B.A.  SIN LLAVE REGULAR (18 lbs) Con Palanca 180°F		2005	31103 31843 31532 38158 38159 22437 22436 38001 38009 K060923 K060930 31103 31843 31532 38158 38159 K040378 22554 35B 3/4" 22437 22436 38001 38009 35B 1/2" 18126 K060930 K060923 K060923 K040378	TAPON DE ACEITE TAPON DE GASOLINA TAPON DE RADIADOR TENSOR MICRO-V TENSOR MICRO-V MANGUERA INF. MANGUERA SUP. POLEA POLEA SERPENTIN SERPENTIN SERPENTIN TAPON DE ACEITE TAPON DE GASOLINA TAPON DE RADIADOR TENSOR MICRO-V TENSOR MICRO-V TRANSMISION DE ACCESORIOS CALEF. A TERMOSTATO CALEF. AUX. A TUBO 2 MANGUERA INF. MANGUERA SUP. POLEA POLEA RADIADOR A TANQ. DE RECUP. RADIADOR A VALV. REG. DE AIR SERPENTIN SERPENTIN SERPENTIN SERPENTIN TAPON DE ACEITE TAPON DE GASOLINA TAPON DE RADIADOR TENSOR MICRO-V TENSOR MICRO-V TERMOSTATO A CALEF. TUBO 1 A CALEF. AUXILIAR VALV. DE AIRE A MOTOR CALEF. A TERMOSTATO CALEF. AUX. A TUBO 2 MANGUERA INF. MANGUERA SUP. POLEA POLEA RADIADOR A TANQ. DE RECUP. RADIADOR A VALV. REG. DE AIR SERPENTIN SERPENTIN SERPENTIN SERPENTIN TAPON DE ACEITE TAPON DE GASOLINA TAPON DE RADIADOR TENSOR MICRO-V TENSOR MICRO-V TERMOSTATO A CALEF. TUBO 1 A CALEF. AUXILIAR VALV. DE AIRE A MOTOR	SIN LLAVE REGULAR (15 lbs) Sin palanca SERPENTIN A.A.  SIN LLAVE REGULAR (15 lbs) Sin palanca SERPENTIN A.A.  C/ALTERNADOR 145A. C/ALTERNADOR 105A. C/ALTERNADOR 105A. A.A.  SIN LLAVE REGULAR (15 lbs) Sin palanca SERPENTIN A.A.  C/ALTERNADOR 105A. C/ALTERNADOR 145A. A.A.  SIN LLAVE REGULAR (15 lbs) Sin palanca SERPENTIN A.A.  SERPENTIN SERPENTIN A.A. SERPENTIN SERPENTIN A.A.

**ESCALADE**

V-8 6.2 L	2010	K040355SF 91030 22437 23184 36299 38009 K060935 31103 31844 31843 31532 39083 33808	A.A. STRECH FIT HERRAMIENTA INST. STRECH F MANGUERA INF. MANGUERA SUP. POLEA POLEA DEL TENSOR SERPENTIN TAPON DE ACEITE TAPON DE GASOLINA TAPON DE GASOLINA TAPONES DE RADIADOR TENSOR TERMOSTATOS	SIN LLAVE  SERPENTIN  CON LLAVE 15 LBS. SERPENTIN 180°	V-8, 5.3 L	2004	22554 35B 3/4" 22437 22436 38001 38009 35B 1/2" 18126 K060930 K060923 K060923 K040378 31103 31843 31532 38158 38159 18914 35B 3/4" 28408 22554 35B 3/4" 22437 22436 38009 38001 35B 1/2" 18126 K060923 K060930 K040378 31103 31843 31532 38158 38159 18914 35B 3/4" 28408 38001 38009 38159 38158 38009	TRANSMISION DE ACCESORIOS CALEF. A TERMOSTATO CALEF. AUX. A TUBO 2 MANGUERA INF. MANGUERA SUP. POLEA POLEA RADIADOR A TANQ. DE RECUP. RADIADOR A VALV. REG. DE AIR SERPENTIN SERPENTIN SERPENTIN SERPENTIN TAPON DE ACEITE TAPON DE GASOLINA TAPON DE RADIADOR TENSOR MICRO-V TENSOR MICRO-V TERMOSTATO A CALEF. TUBO 1 A CALEF. AUXILIAR VALV. DE AIRE A MOTOR CALEF. A TERMOSTATO CALEF. AUX. A TUBO 2 MANGUERA INF. MANGUERA SUP. POLEA POLEA RADIADOR A TANQ. DE RECUP. RADIADOR A VALV. REG. DE AIR SERPENTIN SERPENTIN SERPENTIN SERPENTIN TAPON DE ACEITE TAPON DE GASOLINA TAPON DE RADIADOR TENSOR MICRO-V TENSOR MICRO-V TERMOSTATO A CALEF. TUBO 1 A CALEF. AUXILIAR VALV. DE AIRE A MOTOR	A.A.  A.A.  SERPENTIN SERPENTIN  C/ALTERNADOR 145A. C/ALTERNADOR 105A. C/ALTERNADOR 105A. A.A.  SIN LLAVE REGULAR (15 lbs) Sin palanca SERPENTIN A.A.  C/ALTERNADOR 105A. C/ALTERNADOR 145A. A.A.  SIN LLAVE REGULAR (15 lbs) Sin palanca SERPENTIN A.A.  SERPENTIN SERPENTIN A.A.
V-8 6.2 L	2009	K040355SF 91030 22437 23184 36299 38009 K060935 31103 31844 31844 31532 39083 33808	A.A. STRECH FIT HERRAMIENTA INST. STRECH F MANGUERA INF. MANGUERA SUP. POLEA POLEA DEL TENSOR SERPENTIN TAPON DE ACEITE TAPON DE GASOLINA TAPON DE GASOLINA TAPONES DE RADIADOR TENSOR TERMOSTATOS	SIN LLAVE  SERPENTIN  CON LLAVE 15 LBS. SERPENTIN 180°	V-8, 6.0 L	2004	22554 35B 3/4" 22437 22436 38009 38001 35B 1/2" 18126 K060923 K060930 K040378 31103 31843 31532 38158 38159 18914 35B 3/4" 28408 22554 35B 3/4" 22437 22436 38009 38001 35B 1/2" 18126 K060923 K060930 K040378 31103 31843 31532 38158 38159 18914 35B 3/4" 28408 38001 38009 38159 38158 38009	TRANSMISION DE ACCESORIOS CALEF. A TERMOSTATO CALEF. AUX. A TUBO 2 MANGUERA INF. MANGUERA SUP. POLEA POLEA RADIADOR A TANQ. DE RECUP. RADIADOR A VALV. REG. DE AIR SERPENTIN SERPENTIN SERPENTIN SERPENTIN TAPON DE ACEITE TAPON DE GASOLINA TAPON DE RADIADOR TENSOR MICRO-V TENSOR MICRO-V TERMOSTATO A CALEF. TUBO 1 A CALEF. AUXILIAR VALV. DE AIRE A MOTOR CALEF. A TERMOSTATO CALEF. AUX. A TUBO 2 MANGUERA INF. MANGUERA SUP. POLEA POLEA RADIADOR A TANQ. DE RECUP. RADIADOR A VALV. REG. DE AIR SERPENTIN SERPENTIN SERPENTIN SERPENTIN TAPON DE ACEITE TAPON DE GASOLINA TAPON DE RADIADOR TENSOR MICRO-V TENSOR MICRO-V TERMOSTATO A CALEF. TUBO 1 A CALEF. AUXILIAR VALV. DE AIRE A MOTOR	A.A.  A.A.  SERPENTIN SERPENTIN  C/ALTERNADOR 145A. C/ALTERNADOR 105A. C/ALTERNADOR 105A. A.A.  SIN LLAVE REGULAR (15 lbs) Sin palanca SERPENTIN A.A.  C/ALTERNADOR 105A. C/ALTERNADOR 145A. A.A.  SIN LLAVE REGULAR (15 lbs) Sin palanca SERPENTIN A.A.  SERPENTIN SERPENTIN A.A.
V-8 6.2 L	2008	K040378 22437 23184 36299 38009 36169 K060935 31103 31844 31843 31532 38158 38159 33963	A.A. MANGUERA INF. MANGUERA SUP. POLEA POLEA DEL TENSOR POLEA DEL TENSOR SERPENTIN TAPON DE ACEITE TAPON DE GASOLINA TAPON DE GASOLINA TAPONES DE RADIADOR TENSOR TENSOR TERMOSTATOS	SIN LLAVE  SERPENTIN  CON LLAVE 15 LBS. SERPENTIN A.A. 186°	V-8, 6.0 L	2004	22554 35B 3/4" 22437 22436 38009 38001 35B 1/2" 18126 K060923 K060930 K040378 31103 31843 31532 38158 38159 18914 35B 3/4" 28408 38001 38009 38159 38158 38009	TRANSMISION DE ACCESORIOS CALEF. A TERMOSTATO CALEF. AUX. A TUBO 2 MANGUERA INF. MANGUERA SUP. POLEA POLEA RADIADOR A TANQ. DE RECUP. RADIADOR A VALV. REG. DE AIR SERPENTIN SERPENTIN SERPENTIN SERPENTIN TAPON DE ACEITE TAPON DE GASOLINA TAPON DE RADIADOR TENSOR MICRO-V TENSOR MICRO-V TERMOSTATO A CALEF. TUBO 1 A CALEF. AUXILIAR VALV. DE AIRE A MOTOR	A.A.  A.A.  SERPENTIN SERPENTIN  C/ALTERNADOR 105A. C/ALTERNADOR 145A. A.A.  SIN LLAVE REGULAR (15 lbs) Sin palanca SERPENTIN A.A.  SERPENTIN SERPENTIN A.A.
V-8 6.2 L	2007	22554 22437 23184	MANGUERA DE PASO MANGUERA INF. MANGUERA SUP.	CALEFACTOR AL TERMOSTA°	V-8, 5.3 L	2003	38001 38009 38159 38158 38009	POLEA POLEA TENSOR MICRO-V TENSOR MICRO-V POLEA	SIN LLAVE REGULAR (15 lbs) Sin palanca SERPENTIN A.A. SERPENTIN SERPENTIN
V-8, 6.2 L	2007	22437 38009 36169 38001	MANG. INF. POLEA POLEA POLEA LOCA	SIN LLAVE  SERPENTIN SERPENTIN A.A. SERPENTIN	V-8, 6.0 L	2003	38009	POLEA	SIN LLAVE REGULAR (15 lbs) Sin palanca SERPENTIN A.A. SERPENTIN SERPENTIN





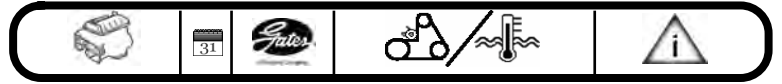

V-8, 4.6 L	1999	19714	TUBO-2 A MOTOR		
V-8, 4.6 L	1998	22079	MANGUERA INF.		
		22080	MANGUERA SUP.		
		38041	POLEA		
		38006	POLEA DEL TENSOR		
		38025	POLEA LOCA		
		K060815	SERPENTIN	C/AA, C/DH	
		K030245	SERPENTIN B.A.	C/AA, C/DH	
		31103	TAPON DE ACEITE		
		31636	TAPON DE GASOLINA	SIN LLAVE REGULAR	
		31528	TAPON DE RADIADOR	(16 lbs) Sin Palanca	4 CIL, 1.8 L
		38153	TENSOR MICRO-V	ACCESORIO	
		38197	TENSOR MICRO-V	B. AGUA	
		33808	TERMOSTATO	180°F	
V-8, 4.6 L	1997	22079	MANGUERA INF.		
		22080	MANGUERA SUP.		
		38006	POLEA DEL TENSOR		
		38001	POLEA LOCA		
		38025	POLEA LOCA		

K060870	SERPENTIN	S/AA, 100 AMP
---------	-----------	---------------

**ASTRA**

4 CIL, 1.8 L	2009	T338	BANDA ARBOL DE LEVAS		146 D X 24 mm
		23476	MANGUERA SUP.		
		K050570	SERPENTIN		SIN A.A.
		K050609	SERPENTIN		CON A.A.
		31843	TAPON DE GASOLINA		
		31844	TAPON DE GASOLINA		CON LLAVE
4 CIL, 1.8 L	2008	T338	BANDA ARBOL DE LEVAS		146 D X 24 mm
		23476	MANGUERA SUP.		
		K050570	SERPENTIN		SIN A.A.
		K050609	SERPENTIN		CON A.A.
		31843	TAPON DE GASOLINA		
		31844	TAPON DE GASOLINA		CON LLAVE
4 CIL, 2.0 L	2008	K060663	SERPENTIN		CON A.A.
		38200	TENSOR MICRO-V		
4 CIL, 1.8 L	2007	T338	BANDA ARBOL DE LEVAS		146 D X 24 mm
		23476	MANGUERA SUP.		
		K050370	SERPENTIN		SIN A.A.
		K050478	SERPENTIN		CON A.A.
		31843	TAPON DE GASOLINA		
		31844	TAPON DE GASOLINA		CON LLAVE
4 CIL, 2.0 L	2007	K060663	SERPENTIN		CON A.A.
		38200	TENSOR MICRO-V		
4 CIL, 2.0 L	2006	T1022	BANDA ARBOL DE LEVAS		
		K060660	SERPENTIN		CON A.A.
		31615	TAPON DE GASOLINA		SIN LLAVE C/CONT. DE EMIS
		31734	TAPON DE GASOLINA		CON LLAVE C/CONT. DE EMIS
		31778	TAPON DE GASOLINA		CON LLAVE REGULAR
		31748	TAPON DE GASOLINA		SIN LLAVE REGULAR
4 CIL, 2.4 L	2006	TPG-14001	TENSOR ARBOL DE LEVAS		
		T305	BANDA ARBOL DE LEVAS		
		TCK305	KIT DE DISTRIBUCION		
		CH-149012	MANGUERA INF.		
		CH-140152	MANGUERA INF.		
		CH-149011	MANGUERA SUP.		
		CH-140111	MANGUERA SUP.		
		K060660	SERPENTIN		C/AA
		31778	TAPON DE GASOLINA		CON LLAVE REGULAR
		31734	TAPON DE GASOLINA		CON LLAVE C/CONT. DE EMIS
		31615	TAPON DE GASOLINA		SIN LLAVE C/CONT. DE EMIS
		31748	TAPON DE GASOLINA		SIN LLAVE REGULAR
4 CIL, 2.0 L	2006	TPG-14002	TENSOR ARBOL DE LEVAS		
		CH-149002	MANGUERA INF.		
		CH-149001	MANGUERA SUP.		
4 CIL, 2.0 L	2005	T1022	BANDA ARBOL DE LEVAS		
		TCK1022	KIT DE DISTRIBUCION		
		K060660	SERPENTIN		CON A.A.
		31748	TAPON DE GASOLINA		SIN LLAVE REGULAR
		31734	TAPON DE GASOLINA		CON LLAVE C/CONT. DE EMIS
		31778	TAPON DE GASOLINA		CON LLAVE REGULAR
		31615	TAPON DE GASOLINA		SIN LLAVE C/CONT. DE EMIS
4 CIL, 2.4 L	2005	TPG-14001	TENSOR ARBOL DE LEVAS		
		T305	BANDA ARBOL DE LEVAS		
		TCK305	KIT DE DISTRIBUCION		
		CH-149012	MANGUERA INF.		
		CH-140152	MANGUERA INF.		
		CH-149011	MANGUERA SUP.		
		CH-140111	MANGUERA SUP.		
		K060660	SERPENTIN		C/AA
		31734	TAPON DE GASOLINA		CON LLAVE C/CONT. DE EMIS
		31615	TAPON DE GASOLINA		SIN LLAVE C/CONT. DE EMIS
		31748	TAPON DE GASOLINA		SIN LLAVE REGULAR
		31778	TAPON DE GASOLINA		CON LLAVE REGULAR
4 CIL, 2.0 L	2005	TPG-14002	TENSOR ARBOL DE LEVAS		
		CH-149002	MANGUERA INF.		
		CH-149001	MANGUERA SUP.		
4 CIL, 2.0 L	2004	T1022	BANDA ARBOL DE LEVAS		
		TCK1022	KIT DE DISTRIBUCION		
		K060660	SERPENTIN		CON A.A.
		31615	TAPON DE GASOLINA		SIN LLAVE C/CONT. DE EMIS
		31748	TAPON DE GASOLINA		SIN LLAVE REGULAR
		31778	TAPON DE GASOLINA		CON LLAVE REGULAR
4 CIL, 2.0 L	2005	TPG-14002	TENSOR ARBOL DE LEVAS		
		CH-149002	MANGUERA INF.		
		CH-149001	MANGUERA SUP.		
4 CIL, 2.0 L	2004	T1022	BANDA ARBOL DE LEVAS		
		TCK1022	KIT DE DISTRIBUCION		
		K060660	SERPENTIN		CON A.A.
		31615	TAPON DE GASOLINA		SIN LLAVE C/CONT. DE EMIS
		31748	TAPON DE GASOLINA		SIN LLAVE REGULAR
		31734	TAPON DE GASOLINA		CON LLAVE C/CONT. DE EMIS











**SRX**

V-6, 3.6 L	2006	K060468	SERPENTIN	ALT. C/BA	
		K060465	SERPENTIN	D.H. & A.A	
		31103	TAPON DE ACEITE		4 CIL, 2.0 L
		31855	TAPON DE GASOLINA		
		31532	TAPON DE RADIADOR	CON LLAVE	
V-6, 3.6 L	2005	35B 3/4"	MANGUERA DE CALEF.	(15 lbs) Sin palanca	4 CIL, 2.0 L
		K060468	SERPENTIN		
		K060465	SERPENTIN		
		31103	TAPON DE ACEITE		
		31855	TAPON DE GASOLINA	CON LLAVE	
		31532	TAPON DE RADIADOR	(15 lbs) Sin palanca	
V-6, 3.6 L	2004	35B 3/4"	MANGUERA DE CALEF.	MOTOR A TANQUE DE RECU4 CIL, 2.4 L	
		31103	TAPON DE ACEITE		
		31855	TAPON DE GASOLINA	CON LLAVE	
		31532	TAPON DE RADIADOR	(15 lbs) Sin palanca	
		K060465	TRANSMISION DE ACCESORIOS	D.H. Y A.A.	
		K060468	TRANSMISION DE ACCESORIOS	ALTERNADOR Y B.A.	
V-8, 4.6 L	2004	35B 3/4"	MANGUERA DE CALEF.	TEE A TUBO 3	
		35B 3/4"	MANGUERA DE CALEF.	TEE A TUBO 2	
		38006	POLEA	ALTERNADOR	
		31103	TAPON DE ACEITE		
		31636	TAPON DE GASOLINA	SIN LLAVE REGULAR	
		31532	TAPON DE RADIADOR	(15 lbs) Sin palanca	
		K050370	TRANSMISION DE ACCESORIOS	ALTERNADOR	4 CIL, 2.0 L











**CHEVROLET**











**400SS**

V-8, 5.7 L	2000	19025	MANGUERA DE PASO	C/AA, C/DH	
		CH-146572	MANGUERA INF.	C/AA, C/DH	
		CH-140441	MANGUERA SUP.	C/AA, C/DH	4 CIL, 2.4 L
		K060960	SERPENTIN	C/AA, 100 AMP	
		K060966	SERPENTIN	C/AA, 140 AMP	
		K060875	SERPENTIN	S/AA, 140 AMP	
		K060870	SERPENTIN	S/AA, 100 AMP	
V-8, 5.7 L	1999	19025	MANGUERA DE PASO	C/AA, C/DH	
		CH-146572	MANGUERA INF.	C/AA, C/DH	
		CH-140441	MANGUERA SUP.	C/AA, C/DH	
		K061145	SERPENTIN	C/AA, C/BH, 140 AMP	
		K060960	SERPENTIN	C/AA, 100 AMP	
		K060966	SERPENTIN	C/AA, 140 AMP	
		K060875	SERPENTIN	S/AA, 140 AMP	
		K060870	SERPENTIN	S/AA, 100 AMP	4 CIL, 2.0 L
V-8, 5.7 L	1998	K060966	SERPENTIN	C/AA, 140 AMP	
		K060960	SERPENTIN	C/AA, 100 AMP	4 CIL, 2.0 L
		K060875	SERPENTIN	S/AA, 140 AMP	
		K060870	SERPENTIN	S/AA, 100 AMP	
V-8, 5.7 L	1997	K060960	SERPENTIN	C/AA, 100 AMP	
		K060966	SERPENTIN	C/AA, 140 AMP	
		K060875	SERPENTIN	S/AA, 140 AMP	

    				    				
4 CIL, 2.0 L	2004	31778 TPG-14001	TAPON DE GASOLINA TENSOR ARBOL DE LEVAS	CON LLAVE REGULAR		31778 31734	TAPON DE GASOLINA TAPON DE GASOLINA	CON LLAVE REGULAR CON LLAVE C/CONT. DE EMI:
4 CIL, 2.4 L	2004	T305 TCK305	BANDA ARBOL DE LEVAS KIT DE DISTRIBUCION		4 CIL, 1.8 L	2000	T1094 TCK1094	BANDA ARBOL DE LEVAS KIT DE DISTRIBUCION
		CH-149012 CH-140152 CH-149011 CH-140111 K060660	MANGUERA INF. MANGUERA INF. MANGUERA SUP. MANGUERA SUP. SERPENTIN	C/AA SIN LLAVE REGULAR CON LLAVE C/CONT. DE EMI: CON LLAVE REGULAR SIN LLAVE C/CONT. DE EMIS			CH-140152 CH-140141 CH-140111 K050478 K050370	MANGUERA INF. MANGUERA SUP. MANGUERA SUP. SERPENTIN SERPENTIN
		31748 31734 31778 31615	TAPON DE GASOLINA TAPON DE GASOLINA TAPON DE GASOLINA TAPON DE GASOLINA				31615 31778 31734 31748	TAPON DE GASOLINA TAPON DE GASOLINA TAPON DE GASOLINA TAPON DE GASOLINA
4 CIL, 2.0 L	2004	TPG-14002 CH-149002	TENSOR ARBOL DE LEVAS MANGUERA INF.			2000	TPG-14004 TMV-14001	TENSOR ARBOL DE LEVAS TENSOR MICRO-V
4 CIL, 1.8 L	2003	CH-149001 T1094	MANGUERA SUP. BANDA ARBOL DE LEVAS		4 CIL, 2.2 L	2000	CH-140162 CH-140131	MANGUERA INF. MANGUERA SUP.
		TCK1094	KIT DE DISTRIBUCION				K060660	SERPENTIN
		CH-140152 CH-140141 CH-140111 K050478 K050370	MANGUERA INF. MANGUERA SUP. MANGUERA SUP. SERPENTIN SERPENTIN	C/AA, S/AA S/AA C/AA C/AA S/AA			31778 31615 31734 31748	TAPON DE GASOLINA TAPON DE GASOLINA TAPON DE GASOLINA TAPON DE GASOLINA
		31615 31748 31734 31778	TAPON DE GASOLINA TAPON DE GASOLINA TAPON DE GASOLINA TAPON DE GASOLINA	SIN LLAVE C/CONT. DE EMIS SIN LLAVE REGULAR CON LLAVE C/CONT. DE EMI: CON LLAVE REGULAR			K040355SF 91030	A.A. STRECH FIT HERRAMIENTA INST. STRECH F
4 CIL, 2.2 L	2003	TPG-14004 TMV-14001	TENSOR ARBOL DE LEVAS TENSOR MICRO-V		V-8, 5.3 L	2010	22437 23184	MANGUERA INF. MANGUERA SUP.
		CH-140162 CH-140131 K060660	MANGUERA INF. MANGUERA SUP. SERPENTIN				36299 38009	POLEA POLEA DEL TENSOR
		31748 31778 31615 31734	TAPON DE GASOLINA TAPON DE GASOLINA TAPON DE GASOLINA TAPON DE GASOLINA	SIN LLAVE REGULAR CON LLAVE REGULAR SIN LLAVE C/CONT. DE EMIS CON LLAVE C/CONT. DE EMI:			K060935 31103 31843 31844	SERPENTIN SERPENTIN TAPON DE ACEITE TAPON DE GASOLINA TAPON DE GASOLINA
4 CIL, 1.8 L	2002	31734 T1094	TAPON DE GASOLINA BANDA ARBOL DE LEVAS				31532 39083	TAPONES DE RADIADOR TENSOR
		TCK1094 CH-140152 CH-140111 CH-140141 K050478 K050370 K050370	KIT DE DISTRIBUCION MANGUERA INF. MANGUERA SUP. MANGUERA SUP. SERPENTIN SERPENTIN SERPENTIN	C/AA, S/AA C/AA S/AA C/AA S/AA S/AA	V-8, 5.3 L	2009	K040355SF 91030	A.A. STRECH FIT HERRAMIENTA INST. STRECH F
		31734 31748 31778 31615	TAPON DE GASOLINA TAPON DE GASOLINA TAPON DE GASOLINA TAPON DE GASOLINA	CON LLAVE C/CONT. DE EMI: SIN LLAVE REGULAR CON LLAVE REGULAR SIN LLAVE C/CONT. DE EMIS			22437 23184 36299 38009	MANGUERA INF. MANGUERA SUP. POLEA POLEA DEL TENSOR
4 CIL, 2.2 L	2002	TPG-14004 TMV-14001	TENSOR ARBOL DE LEVAS TENSOR MICRO-V				K060935 31103 31844	SERPENTIN SERPENTIN TAPON DE ACEITE TAPON DE GASOLINA
		CH-140162 CH-140131 K060660	MANGUERA INF. MANGUERA SUP. SERPENTIN				31843 31532 39083 33808	TAPON DE GASOLINA TAPONES DE RADIADOR TENSOR TERMOSTATOS
		31615 31734 31778 31748	TAPON DE GASOLINA TAPON DE GASOLINA TAPON DE GASOLINA TAPON DE GASOLINA	SIN LLAVE C/CONT. DE EMIS CON LLAVE C/CONT. DE EMI: CON LLAVE REGULAR SIN LLAVE REGULAR	V-8, 5.3 L	2008	K040378 22437	A.A. MANGUERA INF.
4 CIL, 1.8 L	2001	23184 36299 36169 38009	MANGUERA SUP. SERPENTIN POLEA POLEA DEL TENSOR				23184 36299 36169 38009	MANGUERA SUP. POLEA POLEA DEL TENSOR POLEA DEL TENSOR
		T1094	BANDA ARBOL DE LEVAS				K060935 31103 31844	SERPENTIN SERPENTIN TAPON DE ACEITE TAPON DE GASOLINA
		TCK1094	KIT DE DISTRIBUCION				31843 31532	TAPON DE GASOLINA TAPONES DE RADIADOR
		CH-140152 CH-140141 CH-140111 K050478 K050370	MANGUERA INF. MANGUERA SUP. MANGUERA SUP. SERPENTIN SERPENTIN	C/AA, S/AA S/AA C/AA C/AA S/AA			38159 38158 33963	TENSOR TENSOR TERMOSTATOS
		31615 31734 31748 31778	TAPON DE GASOLINA TAPON DE GASOLINA TAPON DE GASOLINA TAPON DE GASOLINA	SIN LLAVE C/CONT. DE EMIS CON LLAVE C/CONT. DE EMI: SIN LLAVE REGULAR CON LLAVE REGULAR	V-8, 5.3 L	2007	22437 38001	MANG. INF. POLEA
4 CIL, 2.2 L	2001	38009 36169 K060935	TAPON DE GASOLINA TAPON DE GASOLINA SERPENTIN				38009 36169 K060935	SERPENTIN POLEA POLEA SERPENTIN
		TMV-14001	TENSOR MICRO-V				K040378 31103 31843	SERPENTIN TAPON DE ACEITE TAPON DE GASOLINA
		CH-140162 CH-140131 K060660	MANGUERA INF. MANGUERA SUP. SERPENTIN				31532 38159	TAPONES DE RADIADOR TENSOR
		31615 31748	TAPON DE GASOLINA TAPON DE GASOLINA	SIN LLAVE C/CONT. DE EMIS SIN LLAVE REGULAR			33963 22437	TERMOSTATOS MANG. INF.











**AVALANCHE**

    				    				
V-8, 5.3 L	2007	38158	TENSOR MICRO-V	SERPENTIN		K060923	SERPENTIN	C/Alt 105A.
V-8, 5.3 L	2006	92092	EDH	PRESION		K060930	SERPENTIN	C/Alt 130A.
		22437	MANG. INF.			31103	TAPON DE ACEITE	
		22436	MANG. SUP.			31832	TAPON DE GASOLINA	SIN LLAVE REGULAR
		38009	POLEA	SERPENTIN		31532	TAPON DE RADIADOR	(15 lbs) Sin palanca
		38001	POLEA LOCA	SERPENTIN		38159	TENSOR MICRO-V	A.A.
		K060923	SERPENTIN	C/ALT 105A		38158	TENSOR MICRO-V	Serpentin
		K060930	SERPENTIN	C/ALT. 145A		33910	TERMOSTATO	180°F
		K040378	SERPENTIN	A.A.	V-8, 8.1 L	28408	VALV. DE AIRE A MOTOR	
		31103	TAPON DE ACEITE		2002	K040400	A.A.	
		31843	TAPON DE GASOLINA	SIN LLAVE REGULAR		38001	POLEA	SERPENTIN
		31532	TAPON DE RADIADOR	(15 lbs) Sin palanca		38009	POLEA DEL TENSOR	
		38158	TENSOR MICRO-V	SERPENTIN		K060956	SERPENTIN	C/Alt de 130A.
		38159	TENSOR MICRO-V	A.A.		K060950	SERPENTIN	C/Alt de 105A.
		33963	TERMOSTATO	186°F		38260	TENSOR MICRO-V	SERPENTIN
V-8, 5.3 L	2005	92092	EDH	PRESION		38259	TENSOR MICRO-V	A.A.
		35B 1/2"	MANGUERA DE CALEF.	RAD A TANQUE DE RECUPERO		<b>AVEO</b>		
		22437	MANGUERA INF.		4 CIL, 1.6 L	2009	T335	BANDA ARBOL DE LEVAS
		22436	MANGUERA SUP.				TCK335	KIT DE DISTRIBUCION
		38009	POLEA				21667	MANGUERA INF.
		38001	POLEA	LOCA			22918	MANGUERA INF.
		K060930	SERPENTIN				21531	MANGUERA SUP.
		K060923	SERPENTIN				20942	MANGUERA SUP.
		K040378	SERPENTIN				38024	POLEA
		31103	TAPON DE ACEITE				38015	POLEA
		31843	TAPON DE GASOLINA	SIN LLAVE REGULAR			T42170	POLEA DISTRIBUCION
		31532	TAPON DE RADIADOR	(15 lbs) Sin palanca			K060739	SERPENTIN
		38159	TENSOR MICRO-V				31844	TAPON DE GASOLINA
		38158	TENSOR MICRO-V				31843	TAPON DE GASOLINA
		33963	TERMOSTATO	186°F			31546	TAPONES DE RADIADOR
V-8, 5.3 L	2004	18914	CALEF. A TERMOSTATO	PRESION			T43039	TENSOR
		92092	EDH				38376	TENSOR
		22437	MANGUERA INF.				33259	TERMOSTATOS
		22436	MANGUERA SUP.				T335	BANDA ARBOL DE LEVAS
		38009	POLEA	SERPENTIN	4 CIL, 1.6 L	2008	21667	MANGUERA INF.
		38001	POLEA	SERPENTIN			22918	MANGUERA INF.
		35B 1/2"	RADIADOR A TANQ. DE RECUP.				20942	MANGUERA SUP.
		18126	RADIADOR A VALV. REG. DE AII				21531	MANGUERA SUP.
		K060923	SERPENTIN	C/ALT. 105A.			38015	POLEA
		K060930	SERPENTIN	C/ALT. 145A.			38024	POLEA
		K040378	SERPENTIN	A.A.			T42170	POLEA DISTRIBUCION
		31103	TAPON DE ACEITE				K060739	SERPENTIN
		31843	TAPON DE GASOLINA	SIN LLAVE REGULAR			31843	TAPON DE GASOLINA
		31532	TAPON DE RADIADOR	(15 lbs) Sin palanca			31844	TAPON DE GASOLINA
		38159	TENSOR MICRO-V	A.A.			31546	TAPON DE RADIADOR
		38158	TENSOR MICRO-V	SERPENTIN			T43039	TENSOR ARBOL DE LEVAS
		33963	TERMOSTATO	186°F			38376	TENSOR MICRO-V
		22554	TERMOSTATO A CALEF.				33259	TERMOSTATOS
		28408	VALV. DE AIRE A MOTOR					
V-8, 5.3 L	2003	K040378	A.A.			<b>BLAZER</b>		
		18914	CALEF. A TERMOSTATO		V-6, 4.3 L	2005	80276	EDH
		80339	EDH	PRESION			19070	MANG. CALEF. A B.A.
		22437	MANGUERA INF.				19707	MANG. CALEF. A MOTOR
		22436	MANGUERA SUP.				19025	MANG. DE CALEFACCION
		38009	POLEA DEL TENSOR				22039	MANG. INF.
		38001	POLEA LOCA				22196	MANG. SUP.
		35B 1/2"	RECUPERADOR				38001	POLEA LOCA
		K060930	SERPENTIN	C/Alt 130A.			38008	POLEA LOCA
		K060923	SERPENTIN	C/Alt 105A.			K060950	POLEA LOCA
		31103	TAPON DE ACEITE				K060870	SERPENTIN
		31832	TAPON DE GASOLINA	SIN LLAVE REGULAR			31103	TAPON DE ACEITE
		31532	TAPON DE RADIADOR	(15 lbs) Sin palanca			31636	TAPON DE GASOLINA
		38159	TENSOR MICRO-V	A.A.			31528	TAPON DE RADIADOR
		38158	TENSOR MICRO-V	Serpentin			38103	TENSOR MICRO-V
		33910	TERMOSTATO	180°F			33019	TERMOSTATO
		28408	VALV. DE AIRE A MOTOR		V-6, 4.3 L	2004	19070	CALEF. A B.A.
V-8, 5.3 L	2002	K040378	A.A.				19707	CALEF. A MOTOR
		18914	CALEF. A TERMOSTATO	PRESION			80276	EDH
		80332	EDH				19025	MAGUERA DE PASO
		18122	MANGUERA DE PASO				22039	MANGUERA INF.
		22437	MANGUERA INF.				22196	MANGUERA SUP.
		22436	MANGUERA SUP.				38008	POLEA LOCA
		38009	POLEA	SERPENTIN			38001	POLEA LOCA
		38001	POLEA	SERPENTIN				
		35B 1/2"	RECUPERADOR					

    				    					
V-6, 4.3 L	2004	K060950 K060870 31103 31636 31782 31518 31528 38103	SERPENTIN SERPENTIN TAPON DE ACEITE TAPON DE GASOLINA TAPON DE GASOLINA TAPON DE RADIADOR TAPON DE RADIADOR TENSOR MICRO-V	C/AA S/AA  SIN LLAVE REGULAR CON LLAVE REGULAR (16 lbs) Con Palanca (16 lbs) Sin Palanca	V-6, 4.3 L	1999	33019 19070 19707 80276 19025 22039 22196 38008 38001 K060950 K060870 31103 31636 31782 31528 31518 38103 33019	TERMOSTATO CALEF. A BA CALEF. A MOTOR EDH MANGUERA DE PASO MANGUERA INF. MANGUERA SUP. POLEA DEL TENSOR POLEA LOCA SERPENTIN SERPENTIN TAPON DE ACEITE TAPON DE GASOLINA TAPON DE GASOLINA TAPON DE RADIADOR TAPON DE RADIADOR TENSOR MICRO-V TERMOSTATO	195°F   PRESION    S/AA C/AA S/AA  SIN LLAVE REGULAR CON LLAVE REGULAR (16 lbs) Sin Palanca (16 lbs) Con Palanca S/AA 195°F PRESION
V-6, 4.3 L	2003	80276 19707 19070 19025 22039 22196 38008 38001 K060950 K060870 31103 31636 31782 31528 31518 38103	EDH MANG. CALEF. A MOTOR MANG. CALEF. A B.A. MANG. DE PASO MANG. INF. MANG. SUP. POLEA POLEA LOCA SERPENTIN SERPENTIN TAPON DE ACEITE TAPON DE GASOLINA TAPON DE GASOLINA TAPON DE RADIADOR TAPON DE RADIADOR TENSOR MICRO-V	PRESION     CORTAR A MEDIDA  LISA C/AA S/AA	V-6, 4.3 L	1998	80276 19025 22039 22196 38008 38001 K060950 K060870 31103 31636 31782 31528 31518 38103 33019	EDH MANGUERA DE PASO MANGUERA INF. MANGUERA SUP. POLEA DEL TENSOR POLEA LOCA SERPENTIN SERPENTIN TAPON DE ACEITE TAPON DE GASOLINA TAPON DE GASOLINA TAPON DE RADIADOR TAPON DE RADIADOR TENSOR MICRO-V TERMOSTATO	PRESION    S/AA C/AA S/AA  SIN LLAVE REGULAR CON LLAVE REGULAR (16 lbs) Sin Palanca (16 lbs) Con Palanca S/AA 195°F PRESION
V-6, 4.3 L	2002	19070 19707 80276 22039 22196 19025 38008 38001 K060950 K060870 31103 31636 31782 31528 31518 38103 33019	CALEF. A BA CALEF. A MOTOR EDH MANGUERA INF. MANGUERA SUP. PASO POLEA POLEA LOCA LISA SERPENTIN SERPENTIN TAPON DE ACEITE TAPON DE GASOLINA TAPON DE GASOLINA TAPON DE RADIADOR TAPON DE RADIADOR TENSOR MICRO-V TERMOSTATO	195°F  PRESION    C/AA S/AA	V-6, 4.3 L	1997	80276 19025 22039 22196 38008 38001 K060950 K060870 31103 31636 31782 31528 31518 38103 33019	EDH MANGUERA DE PASO MANGUERA INF. MANGUERA SUP. POLEA DEL TENSOR POLEA LOCA SERPENTIN SERPENTIN TAPON DE ACEITE TAPON DE GASOLINA TAPON DE GASOLINA TAPON DE RADIADOR TAPON DE RADIADOR TENSOR MICRO-V TERMOSTATO	PRESION    S/AA C/AA S/AA  SIN LLAVE REGULAR CON LLAVE REGULAR (16 lbs) Sin Palanca (16 lbs) Con Palanca S/AA 195°F PRESION
V-6, 4.3 L	2001	19070 19707 80276 22039 22196 19025 38008 38001 K060950 K060870 31103 31636 31782 31518 31528 38103 33019	CALEF. A BA CALEF. A MOTOR EDH MANGUERA INF. MANGUERA SUP. PASO POLEA POLEA LOCA LISA SERPENTIN SERPENTIN TAPON DE ACEITE TAPON DE GASOLINA TAPON DE GASOLINA TAPON DE RADIADOR TAPON DE RADIADOR TENSOR MICRO-V TERMOSTATO	195°F  PRESION    C/AA S/AA	V-6, 4.3 L	2002	19672 22105 22247 22210 38006 38020 K061203 K061010 38118 91817 21717 22648 38008 38006 38001 K061031 K060935 K061025 K060930 31099 31832 31523 38258 33329	CALEF. A TUBO-1 MANGUERA INF. MANGUERA SUP. PASO POLEA DEL TENSOR POLEA LOCA SERPENTIN SERPENTIN TENSOR MICRO-V EDH MANGUERA INF. MANGUERA SUP. POLEA POLEA DEL TENSOR POLEA LOCA LISA SERPENTIN SERPENTIN SERPENTIN TAPON DE ACEITE TAPON DE GASOLINA TAPON DE RADIADOR TENSOR MICRO-V TERMOSTATO	C/Doble Alt 100A. C/Doble Alt 100A. C/Alt de 100A.  PRESION   CON CANALES  C/AA; C/Alt de 130A. S/AA; C/Alt de 130A. C/AA; C/Alt de 105A. S/AA; C/Alt de 105A.  SIN LLAVE REGULAR (16 lbs) Sin Palanca  195°F
V-6, 4.3 L	2000	19070 19707 80276 19025 22039 22196 38008 38001 K060950 K060870 31103 31636 31782 31528 31518 38103 38103	CALEF. A BA CALEF. A MOTOR EDH MANGUERA DE PASO MANGUERA INF. MANGUERA SUP. POLEA POLEA LOCA LISA SERPENTIN SERPENTIN TAPON DE ACEITE TAPON DE GASOLINA TAPON DE GASOLINA TAPON DE RADIADOR TAPON DE RADIADOR TENSOR MICRO-V	PRESION      C/AA S/AA	V-8, 8.1 L	2002	91817 21717 22648 38008 38006 38001 K061031 K060935 K061025 K060930 31099 31832 31523 38258 33329	EDH MANGUERA INF. MANGUERA SUP. POLEA POLEA DEL TENSOR POLEA LOCA LISA SERPENTIN SERPENTIN SERPENTIN TAPON DE ACEITE TAPON DE GASOLINA TAPON DE RADIADOR TENSOR MICRO-V TERMOSTATO	PRESION   CON CANALES  C/AA; C/Alt de 130A. S/AA; C/Alt de 130A. C/AA; C/Alt de 105A. S/AA; C/Alt de 105A.  SIN LLAVE REGULAR (16 lbs) Sin Palanca  195°F

**C v K SERIES PICKUP**



    				    					
V-8, 6.5 L	2001	19672 22105 22247 22210 38006 38020 K061010 K061203 38118	CALEF. A TUBO-1 MANGUERA INF. MANGUERA SUP. PASO POLEA DEL TENSOR POLEA LOCA SERPENTIN SERPENTIN TENSOR MICRO-V		V-8, 5.7 L	1999	38103 361260(802) 19025 CH-146572 21941 CH-140441 22358 38008 38001 38008 38008 K060960 K060966 K061145 K060875 K060870 38103	TENSOR MICRO-V EDH MANGUERA DE PASO MANGUERA INF. MANGUERA SUP. POLEA POLEA POLEA POLEA DEL TENSOR SERPENTIN SERPENTIN SERPENTIN SERPENTIN SERPENTIN TENSOR MICRO-V	PRESION S/AA, C/DH S/AA, C/DH C/AA, C/DH C/AA, C/DH
V-8, 8.1 L	2001	91817 21717 22648 38008 38006 38001 K060930 K060935 K061025 K061031 31099 31832 31523 38258 33329	EDH MANGUERA INF. MANGUERA SUP. POLEA POLEA DEL TENSOR POLEA LOCA LISA SERPENTIN SERPENTIN SERPENTIN SERPENTIN TAPON DE ACEITE TAPON DE GASOLINA TAPON DE RADIADOR TENSOR MICRO-V TERMOSTATO	PRESION  CON CANALES  S/AA, C/Alt de 105A. S/AA, C/Alt de 130A. C/AA, C/Alt de 105A. C/AA, C/Alt de 130A.	V-8, 6.5 L	1999	19672 19663 22105 22247 22210 38006 38020 K061020 K061203 K061010 38118	CALEF. A TUBO-1 INF. - TANQUE A T MANGUERA INF. MANGUERA SUP. PASO POLEA DEL TENSOR POLEA LOCA SERPENTIN SERPENTIN SERPENTIN TENSOR MICRO-V	S/Calef. Auxiliar
V-8, 5.7 L	2000	19025 CH-146572 21941 CH-140441 22358 38001 38008 38008 K060960 K060966 K060870 K060875 38103	MANGUERA DE PASO MANGUERA INF. MANGUERA INF. MANGUERA SUP. MANGUERA SUP. POLEA POLEA POLEA DEL TENSOR SERPENTIN SERPENTIN SERPENTIN SERPENTIN TENSOR MICRO-V	C/AA & S/AA, C/DH S/AA, C/DH C/AA, C/DH C/AA, S/AA, C/DH  LISO  C/AA, 100 AMP C/AA, 140 AMP S/AA, 100 AMP S/AA, 140 AMP	V-8, 7.4 L	1999	91817 21717 22229 19670 38008 38001 38008 K060919 K061005 K061000 K060984 K061080 31099 31832 31523 38103 33329	EDH MANGUERA INF. MANGUERA SUP. PASO POLEA POLEA SERPENTIN SERPENTIN SERPENTIN SERPENTIN SERPENTIN TAPON DE ACEITE TAPON DE GASOLINA TAPON DE RADIADOR TENSOR MICRO-V TERMOSTATO	PRESION    LISO CON CANALES S/AA, S/Comp.; C/Alt de 124A. C/AA, S/Comp.; C/Alt de 124A. C/AA, S/Comp.; C/Alt de 140A. C/AA, S/Comp.; C/Alt de 124A. C/AA, C/Comp.; C/Alt de 124A.
V-8, 6.5 L	2000	19672 22105 22247 22210 38006 38020 K061020 K061010 K061203 38118	CALEF. A TUBO-1 MANGUERA INF. MANGUERA SUP. PASO POLEA DEL TENSOR POLEA LOCA SERPENTIN SERPENTIN SERPENTIN TENSOR MICRO-V	S/Calef. Auxiliar    C/Doble Alt. C/Alt de 124A. C/Alt de 100A.; C/Comp. C/Doble Alt 100A.	V-6, 4.3 L	1998	359530(802) 19025 22086 22228 38008 38001 K060960 K060870 K060875 38103	EDH MANGUERA DE PASO MANGUERA INF. MANGUERA SUP. POLEA POLEA SERPENTIN SERPENTIN SERPENTIN TENSOR MICRO-V	PRESION  C/AA C/AA CON CANALES LISO C/AA, 100 AMP S/AA, 100 AMP S/AA, 140 AMP
V-8, 7.4 L	2000	91817 21717 22229 19670 38008 38001 K061005 K060919 K060984 K061080 31099 31832 31523 38103 33329 19783	EDH MANGUERA INF. MANGUERA SUP. PASO POLEA POLEA LOCA LISA SERPENTIN SERPENTIN SERPENTIN SERPENTIN TAPON DE ACEITE TAPON DE GASOLINA TAPON DE RADIADOR TENSOR MICRO-V TERMOSTATO TUBO-1 A MOTOR	PRESION  CON CANALES  C/AA, S/Comp.; C/Alt de 124A. S/AA, S/Comp.; C/Alt de 124A.V-8, 5.0 L S/AA, C/Comp.; C/Alt de 124A. C/AA, C/Comp.; C/Alt de 124A.	V-8, 5.7 L	1998	361260(802) 38001 38008 38008 38103 361260(802) 19025 21941 CH-140441 22358	EDH POLEA POLEA TENSOR MICRO-V EDH MANGUERA DE PASO MANGUERA INF. MANGUERA SUP. MANGUERA SUP.	PRESION LISO CON CANALES  PRESION C/AA, C/DH C/AA, C/DH C/AA, C/DH
V-8, 5.0 L	1999	361260(802) 21941 21710 22209 25265 19025 38001 38008 K060966 K060960 K060870 K060875	MANGUERA INF. MANGUERA INF. MANGUERA SUP. MANGUERA SUP. PASO POLEA POLEA SERPENTIN SERPENTIN SERPENTIN SERPENTIN SERPENTIN	PRESION S/100A. C/Alt de 100A.  LISO CON CANALES C/AA, C/Alt de 140A. C/AA, C/Alt de 100A., 105A. S/AA, C/Alt de 100A., 105A. S/AA, C/Alt de 140A.	V-6, 4.3 L	1997	359530(802) 19025 22086	EDH MANGUERA DE PASO MANGUERA INF.	PRESION



V-6, 4.3 L	1997	22228 38008 38001 K060960 K060875 K060870 38103	MANGUERA SUP. POLEA POLEA SERPENTIN SERPENTIN SERPENTIN TENSOR MICRO-V	CON CANALES LISO C/AA, 100 AMP S/AA, 140 AMP S/AA, 100 AMP
V-8, 5.0 L	1997	361260(802) 38001 38008 38008 38103	EDH POLEA POLEA POLEA TENSOR MICRO-V	PRESION LISO CON CANALES
V-8, 5.7 L	1997	361260(802) 19025 21941 22209 38008 38001 38008 38008 K060960 K060966 K060875 K060870 38103	EDH MANGUERA DE PASO MANGUERA INF. MANGUERA SUP. POLEA POLEA POLEA POLEA DEL TENSOR SERPENTIN SERPENTIN SERPENTIN SERPENTIN TENSOR MICRO-V	PRESION LISO CON CANALES LISO CON CANALES C/AA, 100 AMP C/AA, 140 AMP S/AA, 140 AMP S/AA, 100 AMP

V-8, 5.7 L	1999	19025 21941 CH-140441 38008 38001 K061145 K060960 K060966 K060875 K060870 38103	MANG. DE PASO MANG. INF. MANG. SUP. POLEA LOCA POLEA LOCA SERPENTIN SERPENTIN SERPENTIN SERPENTIN TENSOR MICRO-V	C/AA C/AA C/AA S/AA C/AA, C/BH, 140 AMP C/AA, 100 AMP C/AA, 140 AMP S/AA, 140 AMP S/AA, 100 AMP
V-8, 5.7 L	1998	19025 21941 CH-140441 38008 38001 K060966 K060960 K060875 K060870 38103	MANG. DE PASO MANG. INF. MANG. SUP. POLEA LOCA POLEA LOCA SERPENTIN SERPENTIN SERPENTIN SERPENTIN TENSOR MICRO-V	C/AA C/AA C/AA S/AA C/AA, 140 AMP C/AA, 100 AMP S/AA, 140 AMP S/AA, 100 AMP
V-8, 5.7 L	1997	19025 21941 22209 38008 38001 K060966 K060960 K060870 K060875 38103	MANG. DE PASO MANG. INF. MANG. SUP. POLEA LOCA POLEA LOCA SERPENTIN SERPENTIN SERPENTIN SERPENTIN TENSOR MICRO-V	C/AA C/AA S/AA

**C-1500**

V-8, 5.7 L	2000	19025 CH-146572 CH-140441 K060960 K060966 K060870 K060875	MANG. DE PASO MANG. INF. MANG. SUP. SERPENTIN SERPENTIN SERPENTIN SERPENTIN	S/AA, C/DH S/AA, C/DH S/AA, C/DH C/AA, 100 AMP C/AA, 140 AMP S/AA, 100 AMP S/AA, 140 AMP
V-8, 5.7 L	1999	19025 CH-146572 CH-140441 K061145 K060960 K060966 K060870 K060875	MANG. DE PASO MANG. INF. MANG. SUP. SERPENTIN SERPENTIN SERPENTIN SERPENTIN SERPENTIN	S/AA, C/DH S/AA, C/DH S/AA, C/DH C/AA, C/BH, 140 AMP C/AA, 100 AMP C/AA, 140 AMP S/AA, 100 AMP S/AA, 140 AMP
V-6, 4.3 L	1998	19025 22086 22228 K060960 K060875 K060870	MANG. DE PASO MANG. INF. MANG. SUP. SERPENTIN SERPENTIN SERPENTIN	C/AA, 100 AMP S/AA, 140 AMP S/AA, 100 AMP
V-8, 5.7 L	1998	K060960 K060966 K060870 K060875	SERPENTIN SERPENTIN SERPENTIN SERPENTIN	C/AA, 100 AMP C/AA, 140 AMP S/AA, 100 AMP S/AA, 140 AMP
V-6, 4.3 L	1997	19025 22086 22228 K060960 K060875 K060870	MANG. DE PASO MANG. INF. MANG. SUP. SERPENTIN SERPENTIN SERPENTIN	C/AA, 100 AMP S/AA, 140 AMP S/AA, 100 AMP
V-8, 5.7 L	1997	K060960 K060966 K060870 K060875	SERPENTIN SERPENTIN SERPENTIN SERPENTIN	C/AA, 100 AMP C/AA, 140 AMP S/AA, 100 AMP S/AA, 140 AMP

**C-3500**

V-8, 5.7 L	2000	19025 21941 22358 38008 38001 K060960 K060966 K060870 K060875 38103	MANG. DE PASO MANG. INF. MANG. SUP. POLEA LOCA POLEA LOCA SERPENTIN SERPENTIN SERPENTIN SERPENTIN TENSOR MICRO-V	S/AA C/AA, 100 AMP C/AA, 140 AMP S/AA, 100 AMP S/AA, 140 AMP
V-8, 5.7 L	1999	19025 21941 22358 38001 38008 K061145 K060966 K060960 K060875 38103	MANG. DE PASO MANG. INF. MANG. SUP. POLEA LOCA POLEA LOCA SERPENTIN SERPENTIN SERPENTIN SERPENTIN TENSOR MICRO-V	S/AA C/AA, C/BH, 140 AMP C/AA, 140 AMP C/AA, 100 AMP S/AA, 140 AMP
V-8, 5.7 L	1998	19025 21941 22358 38001 38008 K060960 K060966 K060875 K060870 38103	MANG. DE PASO MANG. INF. MANG. SUP. POLEA LOCA POLEA LOCA SERPENTIN SERPENTIN SERPENTIN SERPENTIN TENSOR MICRO-V	S/AA C/AA, 100 AMP C/AA, 140 AMP S/AA, 140 AMP S/AA, 100 AMP
V-8, 5.7 L	1997	19025 21941 22358 38008 38001 K060960 K060966 K060875 K060870 38103	MANG. DE PASO MANG. INF. MANG. SUP. POLEA LOCA POLEA LOCA SERPENTIN SERPENTIN SERPENTIN SERPENTIN TENSOR MICRO-V	S/AA C/AA, 100 AMP C/AA, 140 AMP S/AA, 140 AMP S/AA, 100 AMP

**C-2500**

V-8, 5.7 L	2000	19025 21941 CH-140441 38008 38001 K060960 K060966 K060875 K060870 38103	MANG. DE PASO MANG. INF. MANG. SUP. POLEA LOCA POLEA LOCA SERPENTIN SERPENTIN SERPENTIN SERPENTIN TENSOR MICRO-V	C/AA C/AA C/AA S/AA C/AA, 100 AMP C/AA, 140 AMP S/AA, 140 AMP S/AA, 100 AMP
------------	------	--	---	--



**CAMARO Z28**

V-6, 3.8 L	2002	19673	CALEF. A TUBO-1			18908	MANGUERA DE CALEF.	Tubo 1 a motor
		361110(800-	EDH	PRESION		18254	MANGUERA DE CALEF.	RADIADOR A TANQUE DE RE
		22261	MANGUERA INF.			19673	MANGUERA DE CALEF.	Calefacción a tubo 1
		K060945	SERPENTIN			18125	MANGUERA DE PASO	Radiador a bomba de agua sin
		31103	TAPON DE ACEITE			22353	MANGUERA SUP.	Radiador a enfriador de direcc
		31636	TAPON DE GASOLINA	SIN LLAVE REGULAR		38008	POLEA DEL TENSOR	
		31525	TAPON DE RADIADOR	(18 lbs) Sin Palanca		38006	POLEA LOCA	
		33429	TERMOSTATO	195°F		38041	POLEA LOCA	
		18873	TUBO-2 A MOTOR			K060790	SERPENTIN	
V-8, 5.7 L	2002	K040410	A.A.			K040410	SERPENTIN	A.A.
		19673	MANGUERA DE CALEF.	Calefacción a tubo 1		31103	TAPON DE ACEITE	
		18908	MANGUERA DE CALEF.	Motor a tubo 2	V-6, 3.8 L	31636	TAPON DE GASOLINA	SIN LLAVE REGULAR
		18254	MANGUERA DE CALEF.	RADIADOR A TANQUE DE RE		31525	TAPON DE RADIADOR	(18 lbs) Sin Palanca
		18908	MANGUERA DE CALEF.	Tubo 1 a motor	1999	33910	TERMOSTATO	180°F
		18125	MANGUERA DE PASO	Radiador - bomba de agua; S/E		19673	CALEF. A TUBO-1	
		22354	MANGUERA INF.			361110(800-	EDH	PRESION
		22352	MANGUERA SUP.	Sin enfriador de dirección hidrául		22261	MANGUERA INF.	C/AA
		22353	MANGUERA SUP.	Radiador a enfriador de direcc		22262	MANGUERA SUP.	C/AA
		21528	MANGUERA SUP.	Enfriador de dirección hidráulic		K060945	SERPENTIN	
		38008	POLEA DEL TENSOR			31103	TAPON DE ACEITE	
		38041	POLEA LOCA			31636	TAPON DE GASOLINA	SIN LLAVE REGULAR
		38006	POLEA LOCA			31525	TAPON DE RADIADOR	(18 lbs) Sin Palanca
		K060790	SERPENTIN		V-8, 5.7 L	33429	TERMOSTATO	195°F
		31103	TAPON DE ACEITE			18873	TUBO-2 A MOTOR	
		31636	TAPON DE GASOLINA	SIN LLAVE REGULAR		K040410	A.A.	
		31525	TAPON DE RADIADOR	(18 lbs) Sin Palanca		19673	CALEF. A TUBO-1	
		33910	TERMOSTATO	180°F		18959	MANGUERA DE CALEF.	C/AA, C/DH
		30T 5/8"	TUBO-2 A CALEF.			22354	MANGUERA INF.	
		35B 1/4"	VALV. REG. DE AIRE A MOTOR			22352	MANGUERA SUP.	S/Enfriador de DH
V-6, 3.8 L	2001	19673	CALEF. A TUBO-1			38008	POLEA DEL TENSOR	S/Enfriador de Aceite de motor
		361110(800-	EDH	PRESION		38006	POLEA LOCA	
		22261	MANGUERA INF.	C/AA		K060790	SERPENTIN	
		22262	MANGUERA SUP.	C/AA	V-6, 3.8 L	21528	SUP. - D.H. Cooler A MOTOR	
		K060945	SERPENTIN			22353	SUP. - RADIADOR A D.H. Cooler	
		31103	TAPON DE ACEITE		1998	361110(800-	EDH	PRESION
		31636	TAPON DE GASOLINA	SIN LLAVE REGULAR		22261	MANGUERA INF.	C/AA
		31525	TAPON DE RADIADOR	(18 lbs) Sin Palanca		22262	MANGUERA SUP.	C/AA
		33429	TERMOSTATO	195°F		K060945	SERPENTIN	
		18873	TUBO-2 A MOTOR			31103	TAPON DE ACEITE	
V-8, 5.7 L	2001	18908	MANGUERA DE CALEF.	Motor a tubo 2		31850	TAPON DE GASOLINA	
		18908	MANGUERA DE CALEF.	Tubo 1 a motor	V-8, 5.7 L	31525	TAPON DE RADIADOR	(18 lbs) Sin Palanca
		18254	MANGUERA DE CALEF.	RADIADOR A TANQUE DE RE		33429	TERMOSTATO	195°F
		19673	MANGUERA DE CALEF.	Calefacción a tubo 1	1998	K040410	A.A.	
		18125	MANGUERA DE PASO	Radiador a bomba de agua sin		18959	MANGUERA DE CALEF.	C/AA, C/DH
		22354	MANGUERA INF.			18125	MANGUERA DE PASO	C/AA, C/DH
		21528	MANGUERA SUP.	Enfriador de dirección hidráulic		22354	MANGUERA INF.	C/AA, C/DH
		22352	MANGUERA SUP.	S/Enfriador de DH		22353	MANGUERA SUP.	C/AA, C/DH
		22353	MANGUERA SUP.	Radiador a enfriador de direcc		38008	POLEA DEL TENSOR	
		38008	POLEA DEL TENSOR			38006	POLEA LOCA	
		38041	POLEA LOCA		V-6, 3.8 L	K060790	SERPENTIN	
		38006	POLEA LOCA			361110(800-	EDH	PRESION
		K060790	SERPENTIN			22261	MANGUERA INF.	C/AA
		K040410	SERPENTIN	A.A.		22262	MANGUERA SUP.	C/AA
		31103	TAPON DE ACEITE			K060945	SERPENTIN	C/AA
		31636	TAPON DE GASOLINA	SIN LLAVE REGULAR		K060832	SERPENTIN	S/AA
		31525	TAPON DE RADIADOR	(18 lbs) Sin Palanca		K060832	SERPENTIN	S/AA
		33910	TERMOSTATO	180°F		31103	TAPON DE ACEITE	
V-6, 3.8 L	2000	19673	CALEF. A TUBO-1			31633	TAPON DE GASOLINA	SIN LLAVE REGULAR
		361110(800-	EDH	PRESION	V-8, 5.7 L	31525	TAPON DE RADIADOR	(18 lbs) Sin Palanca
		22261	MANGUERA INF.	C/AA		33429	TERMOSTATO	195°F
		22262	MANGUERA SUP.	C/AA		22263	MANGUERA INF.	
		K060945	SERPENTIN			21439	MANGUERA SUP.	
		31103	TAPON DE ACEITE			38001	POLEA DEL TENSOR	
		31636	TAPON DE GASOLINA	SIN LLAVE REGULAR		38145	TENSOR MICRO-V	
		31525	TAPON DE RADIADOR	(18 lbs) Sin Palanca				
		33429	TERMOSTATO	195°F				
		18873	TUBO-2 A MOTOR					
V-8, 5.7 L	2000	18959	MANG. DE CALEFACCION	C/AA, C/DH				
		22354	MANG. INF.	C/AA, C/DH				
		21528	MANG. SUP.	ENFRIADOR DE D.H. A MOTC				
		22352	MANG. SUP.	S/ENFRIADOR DE D.H.				
		18908	MANGUERA DE CALEF.	Motor a tubo 2				

**CAPTIVA**

V-8, 5.7 L	2010	23164	MANGUERA INF.			23164	MANGUERA INF.	
		21171	MANGUERA SUP.			21171	MANGUERA SUP.	
		38011	POLEA			38011	POLEA	
		36193	POLEA DEL TENSOR			36193	POLEA DEL TENSOR	
		K050407	SERPENTIN			K050407	SERPENTIN	
		31103	TAPON DE ACEITE			31103	TAPON DE ACEITE	
		31844	TAPON DE GASOLINA			31844	TAPON DE GASOLINA	CON LLAVE

4 CIL, 2.4 L	2010	31843	TAPON DE GASOLINA					31103	TAPON DE ACEITE						
		31532	TAPONES DE RADIADOR	15 LBS.				31636	TAPON DE GASOLINA					SIN LLAVE REGULAR	
		38177	SENSOR					31782	TAPON DE GASOLINA					CON LLAVE REGULAR	
		33943	TERMOSTATOS	180°				31532	TAPON DE RADIADOR					(15 lbs) Sin palanca	
V-6, 3.6 L	2010	23490	MANGUERA INF.					38177	SENSOR MICRO-V						
		23495	MANGUERA SUP.		4 CIL, 2.2 L		2003	19815	CALEF. A MOTOR						
		K060930	SERPENTIN					80301	EDH					PRESION, CAJA A DIR.	
		31103	TAPON DE ACEITE					19611	MANG. INF. TUBO A TANQ. REC						
		38143	TAPON DE GASOLINA					22708	MANGUERA INF.						
		38144	TAPON DE GASOLINA	CON LLAVE				22345	MANGUERA SUP.						
		31532	TAPONES DE RADIADOR	15 LBS.				19816	MOTOR A CALEF.						
		38397	SENSOR					38011	POLEA LOCA						
4 CIL, 2.4 L	2009	33943	TERMOSTATOS	180°				35B 3/8"	RADIADOR A TANQ.DE REC.						
		23164	MANGUERA INF.					K050345	SERPENTIN					S/AA	
		21171	MANGUERA SUP.					K050400	SERPENTIN					C/AA	
		38011	POLEA					35B 3/8"	TANQUE DE RECUPERACION A						
		36193	POLEA DEL TENSOR					31103	TAPON DE ACEITE						
		K050407	SERPENTIN					31636	TAPON DE GASOLINA					SIN LLAVE REGULAR	
		31103	TAPON DE ACEITE					31782	TAPON DE GASOLINA					CON LLAVE REGULAR	
		31843	TAPON DE GASOLINA					31532	TAPON DE RADIADOR					(15 lbs) Sin palanca	
		31844	TAPON DE GASOLINA	CON LLAVE				38177	SENSOR MICRO-V						
		31532	TAPONES DE RADIADOR	15 LBS.	4 CIL, 2.2 L		2002	19811	CALEF. A TUBO-1						
		38177	SENSOR					80051	EDH					Motor Numero de serie 4	
		33943	TERMOSTATOS	180°				353110(803)	EDH					PRESION	
V-6, 3.6 L	2009	23490	MANGUERA INF.					22708	MANG. INF.					SERIE F	
		23495	MANGUERA SUP.					19611	MANGUERA INF.					Motor Numero de serie F; TUB	
		K060930	SERPENTIN					22343	MANGUERA INF.					Motor Numero de serie 4	
		31103	TAPON DE ACEITE					22342	MANGUERA SUP.					Motor Numero de serie 4	
		38144	TAPON DE GASOLINA	CON LLAVE				22345	MANGUERA SUP.					Motor Numero de serie F	
		38143	TAPON DE GASOLINA					38015	POLEA						
		31532	TAPONES DE RADIADOR	15 LBS.				38011	POLEA DEL TENSOR						
		38397	SENSOR					35B 3/8"	RECUPERADOR					Motor Numero de serie F	
		33943	TERMOSTATOS	180°				K050630	SERPENTIN					S/AA; Motor número de serie 4	
4 CIL, 2.4 L	2008	23164	MANGUERA INF.					K050887	SERPENTIN					C/AA; Motor serie 4	
		21171	MANGUERA SUP.					K050400	SERPENTIN					C/AA; Motor número de serie F	
		38011	POLEA					35B 3/8"	TANQUE DE RECUPERACION A					Motor Numero de serie F	
		K050407	SERPENTIN					31103	TAPON DE ACEITE						
		31103	TAPON DE ACEITE					31636	TAPON DE GASOLINA					SIN LLAVE REGULAR	
		31844	TAPON DE GASOLINA	CON LLAVE				31782	TAPON DE GASOLINA					CON LLAVE REGULAR	
		31843	TAPON DE GASOLINA					31532	TAPON DE RADIADOR					(15 lbs) Sin palanca	
		38177	SENSOR MICRO-V					38164	SENSOR MICRO-V						
		33943	TERMOSTATO	180 ° F				38177	SENSOR MICRO-V						
V-6, 3.6 L	2008	23490	MANGUERA INF.					33943	TERMOSTATO					180°F	
		23495	MANGUERA SUP.					20618	TERMOSTATO A TUBO-3					Motor Numero de serie 4	
		K060930	SERPENTIN					19736	TUBO-1 A "T"					Motor Numero de serie 4	
		31103	TAPON DE ACEITE					28408	TUBO-2 A TANQ. DE RECUP.					Motor Numero de serie 4	
		31843	TAPON DE GASOLINA					19810	TUBO-3 A CALEF.					Motor Numero de serie 4	
		31844	TAPON DE GASOLINA	CON LLAVE	4 CIL, 2.2 L		2001	19811	CALEF. A TUBO-1						
		38397	SENSOR MICRO-V					80051	EDH					PRESION	

**CAVALIER**

4 CIL, 2.2 L	2005	71798	EDH	RETORNO				38015	POLEA DEL TENSOR						
		35B 3/8"	MANGUERA DE CALEFACCIÓN	TANQUE DE RECUPERACION				38011	POLEA LOCA						
		35B 3/8"	MANGUERA DE CALEFACCIÓN	RAD A TANQUE DE RECUEPI				K050630	SERPENTIN					S/AA	
		22708	MANGUERA INF.					K050887	SERPENTIN					C/AA	
		22345	MANGUERA SUP.					31121	TAPON DE ACEITE						
		38011	POLEA					31636	TAPON DE GASOLINA					SIN LLAVE REGULAR	
		K050400	SERPENTIN					31782	TAPON DE GASOLINA					CON LLAVE REGULAR	
		31103	TAPON DE ACEITE					31532	TAPON DE RADIADOR					(15 lbs) Sin palanca	
		31636	TAPON DE GASOLINA	SIN LLAVE REGULAR				38164	SENSOR MICRO-V						
		31532	TAPON DE RADIADOR	(15 lbs) Sin palanca				33828	TERMOSTATO					180°F	
		38177	SENSOR MICRO-V					20618	TERMOSTATO A TUBO-3						
		33943	TERMOSTATO	180°F	4 CIL, 2.2 L		2000	19811	CALEF. A TUBO-1						
4 CIL, 2.2 L	2004	19815	CALEF. A MOTOR					80051	EDH					PRESION	
		80301	EDH	PRESION, CAJA A DIR.				22148	MANGUERA INF.						
		19611	INF. TUBO A TANQUE					22343	MANGUERA INF.						
		22708	MANGUERA INF.					22342	MANGUERA SUP.						
		22345	MANGUERA SUP.					38015	POLEA DEL TENSOR						
		19816	MOTOR A CALEF.					38011	POLEA LOCA						
		38011	POLEA					K050887	SERPENTIN					C/AA	
		35B 3/8"	RADIADOR A TANQ.DE REC.					K050630	SERPENTIN					S/AA	
		K050345	SERPENTIN	S/AA				31121	TAPON DE ACEITE						
		K050400	SERPENTIN	C/AA				31636	TAPON DE GASOLINA					SIN LLAVE REGULAR	
		35B 3/8"	TANQUE DE RECUPERACION A					31782	TAPON DE GASOLINA					CON LLAVE REGULAR	
								31532	TAPON DE RADIADOR					(15 lbs) Sin palanca	

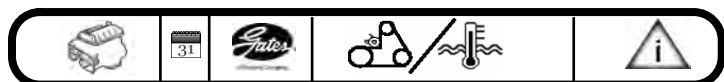

4 CIL, 2.2 L	2000	38164 33828 20618	TENSOR MICRO-V TERMOSTATO TERMOSTATO A TUBO-3	180°F
4 CIL, 2.2 L	1999	19704 19703 80051 22343 22148 22342 38015 38011 K050887 K050630 31121 31636 31782 31532 38164 33828	CALEF. A MOTOR CALEF. A TUBO EDH MANGUERA INF. MANGUERA INF. MANGUERA SUP. POLEA DEL TENSOR POLEA LOCA SERPENTIN SERPENTIN TAPON DE ACEITE TAPON DE GASOLINA TAPON DE GASOLINA TAPON DE RADIADOR TENSOR MICRO-V TERMOSTATO	Re-usar el restrictor de flujo  PRESION  C/AA S/AA  SIN LLAVE REGULAR CON LLAVE REGULAR (15 lbs) Sin palanca  180°F PRESION, CAJA A DIR.
4 CIL, 2.4 L	1999	362810(800) CH-140491 22148 22152 38032 K050478 31111 31636 31782 31532 38247 33828	EDH MANG. SUP. MANGUERA INF. MANGUERA SUP. POLEA SERPENTIN TAPON DE ACEITE TAPON DE GASOLINA TAPON DE GASOLINA TAPON DE RADIADOR TENSOR MICRO-V TERMOSTATO	SIN LLAVE REGULAR CON LLAVE REGULAR (15 lbs) Sin palanca  180°F PRESION
4 CIL, 2.2 L	1998	80051 22148 22342 38011 38015 K050630 K050887 31121 31636 31782 31405 31532 38164	EDH MANGUERA INF. MANGUERA SUP. POLEA POLEA DEL TENSOR SERPENTIN SERPENTIN TAPON DE ACEITE TAPON DE GASOLINA TAPON DE GASOLINA TAPON DE RADIADOR TAPON DE RADIADOR TENSOR MICRO-V	S/AA C/AA  SIN LLAVE REGULAR CON LLAVE REGULAR (15 lbs) Sin palanca  180°F PRESION
4 CIL, 2.4 L	1998	362810(800) CH-140491 22148 22152 38011 K050474 31111 31636 31782 31532 31405 38146 33828	EDH MANG. SUP. MANGUERA INF. MANGUERA SUP. POLEA SERPENTIN TAPON DE ACEITE TAPON DE GASOLINA TAPON DE GASOLINA TAPON DE RADIADOR TAPON DE RADIADOR TENSOR MICRO-V TERMOSTATO	PRESION, CAJA A DIR.  S/AA  SIN LLAVE REGULAR CON LLAVE REGULAR (15 lbs) Sin palanca (15 lbs) Sin palanca  180°F PRESION
4 CIL, 2.2 L	1997	80051 22211 CH-140511 38026 K050705 K050835 31636 31782 31405 31532 38110	EDH MANGUERA INF. MANGUERA SUP. POLEA SERPENTIN SERPENTIN TAPON DE GASOLINA TAPON DE GASOLINA TAPON DE RADIADOR TAPON DE RADIADOR TENSOR MICRO-V	S/AA C/AA  SIN LLAVE REGULAR CON LLAVE REGULAR (15 lbs) Sin palanca (15 lbs) Sin palanca  180°F PRESION
4 CIL, 2.4 L	1997	362810(800) 22148 22152 38011 K050474 31111 31636 31782 31405 31532 38110	EDH MANGUERA INF. MANGUERA SUP. POLEA DEL TENSOR SERPENTIN TAPON DE ACEITE TAPON DE GASOLINA TAPON DE RADIADOR TAPON DE RADIADOR TENSOR MICRO-V	PRESION, CAJA A DIR.  S/AA  SIN LLAVE REGULAR

4 CIL, 2.4 L	2002	31782 31532 31405 38146 33828	TAPON DE GASOLINA TAPON DE RADIADOR TAPON DE RADIADOR TENSOR MICRO-V TERMOSTATO	CON LLAVE REGULAR (15 lbs) Sin palanca (15 lbs) Sin palanca  180°F
--------------	------	---	---	--

## CAVALIER Z24











4 CIL, 2.4 L	2002	22148 CH-140491 38032 K050478 38247	MANG. INF. MANG. SUP. POLEA SERPENTIN TENSOR MICRO-V	
4 CIL, 2.4 L	2001	22148 CH-140491 38032 K050478 38247	MANG. INF. MANG. SUP. POLEA SERPENTIN TENSOR MICRO-V	
4 CIL, 2.4 L	2000	22148 CH-140491 38032 K050478 38247	MANG. INF. MANG. SUP. POLEA SERPENTIN TENSOR MICRO-V	
4 CIL, 2.4 L	1999	22148 CH-140491 38032 K050478 38247	MANG. INF. MANG. SUP. POLEA SERPENTIN TENSOR MICRO-V	
4 CIL, 2.4 L	1998	22148 CH-140491 38032 K050478 38247	MANG. INF. MANG. SUP. POLEA SERPENTIN TENSOR MICRO-V	
4 CIL, 2.4 L	1997	22148 CH-140491	MANGUERA INF. MANGUERA SUP.	

## CENTURY

V-6, 3.1 L	1999	92054 38001 K060703 31103 31636 31516 38105 33329	EDH POLEA DEL TENSOR SERPENTIN TAPON DE ACEITE TAPON DE GASOLINA TAPON DE RADIADOR TENSOR MICRO-V TERMOSTATO	PRESION    SIN LLAVE REGULAR (16 lbs) Con palanca  195°F PRESION
V-6, 3.1 L	1998	91934 38001 K060695 31103 31782 31523 38105 33329	EDH POLEA DEL TENSOR SERPENTIN TAPON DE ACEITE TAPON DE GASOLINA TAPON DE RADIADOR TENSOR MICRO-V TERMOSTATO	195°F PRESION   CON LLAVE REGULAR (16 lbs) Sin Palanca  195°F PRESION
V-6, 3.1 L	1997	91934 CH-141102 1517T225 CH-147211 12T172 38007 K060695 31636 38105	EDH MANGUERA INF. MANGUERA INF. FLEXIBLE MANGUERA SUP. MANGUERA SUP. FLEXIBLE POLEA DEL TENSOR SERPENTIN TAPON DE GASOLINA TENSOR MICRO-V	SIN LLAVE REGULAR

## CHEVY

4 CIL, 1.6 L	2010	T203 6362GS TCK203 CH-140187 CH-140253 CH-140184 CH-149203 CH-140482 CH-140451 CH-140471	BANDA ARBOL DE LEVAS BANDA V KIT DE DISTRIBUCION MANG. TANQ. DE REC. MANGUERA B.A. MANGUERA CALEF. ENTRADA MANGUERA DE PASO MANGUERA INF. MANGUERA SUP. MANGUERA SUP.	111 D X 17.0 mm ALT. SIN A.A.        SIN A.A. CON A.A.
--------------	------	---	--	--

    		    							
4 CIL, 1.6 L	2010	T36038 36152 K060708 K060570 31778 31734 TPG-14003 38200 13346	POLEA POLEA DEL TENSOR SERPENTIN SERPENTIN TAPON DE GASOLINA TAPON DE GASOLINA TENSOR TENSOR TERMOSTATOS	CON A.A. CON A.A. SIN A.A. CON LLAVE CON CONTROL DE EMISIONE	CH-140184 CH-140482 CH-140451 CH-140471 CH-140187 CH-149203 36152 T36038 K060570 K060708 K060570 31734 31778 TPG-14003 38200 13346	MANG. DE CALEF. ENTRADA MANG. INF. MANG. SUP. MANG. SUP. MANG. TANQUE DE RECUP. MANGUERA DE PASO POLEA DEL TENSOR POLEA LOCA SERPENTIN SERPENTIN SERPENTIN TAPON DE GASOLINA TAPON DE GASOLINA TENSOR ARBOL DE LEVAS TENSOR MICRO-V TERMOSTATO	S/AA C/AA S/AA C/AA S/AA CON LLAVE C/CONT. DE EMI: CON LLAVE REGULAR 160°F ALT. S/AA		
4 CIL, 1.6 L	2009	T203 6362GS TCK203 CH-140187 CH-140253 CH-140184 CH-140482 CH-140471 CH-140451 T36038 36152 K060570 K060708 31778 31734 38200 TPG-14003 13346	BANDA ARBOL DE LEVAS BANDA V KIT DE DISTRIBUCION MANG. TANQ. DE REC. MANGUERA B.A. MANGUERA DE CALEF. ENTRADA MANGUERA DE PASO MANGUERA INF. MANGUERA SUP. MANGUERA SUP. POLEA POLEA DEL TENSOR SERPENTIN SERPENTIN TAPON DE GASOLINA TAPON DE GASOLINA TENSOR TENSOR TERMOSTATOS	160° 111 D X 17.0 mm ALT. SIN A.A. CON A.A. SIN A.A. CON A.A. SIN A.A. CON A.A. CON LLAVE CON CONTROL DE EMISIONE 160°	4 CIL, 1.6 L	2005	T203 6362GS TCK203 CH-140253 CH-140184 CH-140482 CH-140451 CH-140471 CH-140187 CH-149203 36152 T36038 K060570 K060570 K060708 31734 31778 TPG-14003 38200 13346	BANDA ARBOL DE LEVAS BANDA V KIT DE DISTRIBUCION MANG. B.A. MANG. DE CALEF. ENTRADA MANG. INF. MANG. SUP. MANG. SUP. MANG. TANQUE DE RECUP. MANGUERA DE PASO POLEA DEL TENSOR POLEA LOCA SERPENTIN SERPENTIN SERPENTIN TAPON DE GASOLINA TAPON DE GASOLINA TENSOR ARBOL DE LEVAS TENSOR MICRO-V TERMOSTATO	S/AA C/AA S/AA CON LLAVE C/CONT. DE EMI: CON LLAVE REGULAR 160°F ALT. S/AA











**CHEVY C2**











4 CIL, 1.6 L	2008	T203 6362GS TCK203 CH-140253 CH-140184 CH-140482 CH-140471 CH-140451 CH-140187 CH-149203 36152 T36038 K060708 K060570 K060570 31734 31778 TPG-14003 38200 13346	BANDA ARBOL DE LEVAS BANDA V KIT DE DISTRIBUCION MANG. B.A. MANG. DE CALEF. ENTRADA MANG. INF. MANG. SUP. MANG. SUP. MANG. TANQUE DE RECUP. MANGUERA DE PASO POLEA DEL TENSOR POLEA LOCA SERPENTIN SERPENTIN SERPENTIN TAPON DE GASOLINA TAPON DE GASOLINA TENSOR ARBOL DE LEVAS TENSOR MICRO-V TERMOSTATO	ALT. S/AA C/AA S/AA C/AA S/AA CON LLAVE C/CONT. DE EMI: CON LLAVE REGULAR 160°F	4 CIL, 1.6 L	2004	T203 6362GS TCK203 CH-140253 CH-140184 CH-140482 CH-140451 CH-140471 CH-140187 CH-149203 36152 T36038 K060708 K060570 K060570 31734 31778 TPG-14003 38200 13346	BANDA ARBOL DE LEVAS BANDA V KIT DE DISTRIBUCION MANG. B.A. MANG. DE CALEF. ENTRADA MANG. INF. MANG. SUP. MANG. SUP. MANG. TANQUE DE RECUP. MANGUERA DE PASO POLEA DEL TENSOR POLEA LOCA SERPENTIN SERPENTIN SERPENTIN TAPON DE GASOLINA TAPON DE GASOLINA TENSOR ARBOL DE LEVAS TENSOR MICRO-V TERMOSTATO	ALT. S/AA C/AA S/AA C/AA S/AA CON LLAVE C/CONT. DE EMI: CON LLAVE REGULAR 160°F
4 CIL, 1.6 L	2007	T203 6362GS TCK203 CH-140253 CH-140184 CH-140482 CH-140471 CH-140451 CH-140187 CH-149203 36152 T36038 K060708 K060570 K060570 31734 31778 TPG-14003 38200 13346	BANDA ARBOL DE LEVAS BANDA V KIT DE DISTRIBUCION MANG. B.A. MANG. DE CALEF. ENTRADA MANG. INF. MANG. SUP. MANG. SUP. MANG. TANQUE DE RECUP. MANGUERA DE PASO POLEA DEL TENSOR POLEA LOCA SERPENTIN SERPENTIN SERPENTIN TAPON DE GASOLINA TAPON DE GASOLINA TENSOR ARBOL DE LEVAS TENSOR MICRO-V TERMOSTATO	ALT. S/AA C/AA S/AA CON LLAVE C/CONT. DE EMI: CON LLAVE REGULAR 160°F	4 CIL, 1.6 L	2006	T203 6362GS TCK203 CH-140253 CH-140184 CH-140482 CH-140471 CH-140451 CH-140187 CH-149203 36152 T36038 K060708 K060570 K060570 31734 31778 TPG-14003 38200 13346	BANDA ARBOL DE LEVAS BANDA V KIT DE DISTRIBUCION MANG. B.A. MANG. DE CALEF. ENTRADA MANG. INF. MANG. SUP. MANG. SUP. MANG. TANQUE DE RECUP. MANGUERA DE PASO POLEA DEL TENSOR POLEA LOCA SERPENTIN SERPENTIN SERPENTIN TAPON DE GASOLINA TAPON DE GASOLINA TENSOR ARBOL DE LEVAS TENSOR MICRO-V TERMOSTATO	ALT. S/AA C/AA S/AA CON LLAVE C/CONT. DE EMI: CON LLAVE REGULAR 160°F

**CHEVY C2 SEDAN**

4 CIL, 1.6 L	2008	T203 6362GS TCK203 CH-140253 CH-140184 CH-140482 CH-140451 CH-140471 CH-140187 CH-149203 36152 T36038 K060708 K060570 K060570 31778 TPG-14003	BANDA ARBOL DE LEVAS BANDA V KIT DE DISTRIBUCION MANG. B.A. MANG. DE CALEF. ENTRADA MANG. INF. MANG. SUP. MANG. SUP. MANG. TANQUE DE RECUP. MANGUERA DE PASO POLEA DEL TENSOR POLEA LOCA SERPENTIN SERPENTIN SERPENTIN TAPON DE GASOLINA TAPON DE GASOLINA TENSOR ARBOL DE LEVAS	ALT. S/AA C/AA S/AA S/AA CON LLAVE C/CONT. DE EMI: CON LLAVE REGULAR 160°F	4 CIL, 1.6 L	2006	T203 6362GS TCK203 CH-140253 CH-140184 CH-140482 CH-140451 CH-140471 CH-140187 CH-149203 36152 T36038 K060708 K060570 K060570 31778 TPG-14003	BANDA ARBOL DE LEVAS BANDA V KIT DE DISTRIBUCION MANG. B.A. MANG. DE CALEF. ENTRADA MANG. INF. MANG. SUP. MANG. SUP. MANG. TANQUE DE RECUP. MANGUERA DE PASO POLEA DEL TENSOR POLEA LOCA SERPENTIN SERPENTIN SERPENTIN TAPON DE GASOLINA TAPON DE GASOLINA TENSOR ARBOL DE LEVAS	ALT. S/AA C/AA S/AA S/AA CON LLAVE C/CONT. DE EMI: CON LLAVE REGULAR 160°F
--------------	------	---	---	--	--------------	------	---	---	--



    		    							
4 CIL, 1.6 L	2008	38200	TENSOR MICRO-V		13346	TERMOSTATO	160°F		
4 CIL, 1.6 L	2007	T203	BANDA ARBOL DE LEVAS	ALT. S/AA	<b>CHEVY JOY</b>				
		6362GS	BANDA V						
		TCK203	KIT DE DISTRIBUCION		4 CIL, 1.6 L	2003	T203	BANDA ARBOL DE LEVAS	
		CH-140253	MANG. B.A.				6362GS	BANDA V	ALT. S/AA
		CH-140184	MANG. DE CALEF. ENTRADA				TCK203	KIT DE DISTRIBUCION	
		CH-140482	MANG. INF.				CH-140253	MANG. B.A.	
		CH-140451	MANG. SUP.	S/AA			CH-140184	MANG. DE CALEF. ENTRADA	
		CH-140471	MANG. SUP.	C/AA			CH-140482	MANG. INF.	
		CH-140187	MANG. TANQUE DE RECUP.				CH-140471	MANG. SUP.	C/AA
		CH-149203	MANGUERA DE PASO				CH-140451	MANG. SUP.	S/AA
		36152	POLEA DEL TENSOR				CH-140187	MANG. TANQUE DE RECUP.	
		T36038	POLEA LOCA				T36038	POLEA LOCA	
		K060570	SERPENTIN	S/AA			K060705	SERPENTIN	C/AA
		K060708	SERPENTIN	C/AA			K060570	SERPENTIN	S/AA
		31778	TAPON DE GASOLINA	CON LLAVE REGULAR			31778	TAPON DE GASOLINA	CON LLAVE REGULAR
		31734	TAPON DE GASOLINA	CON LLAVE C/CONT. DE EMI:			31734	TAPON DE GASOLINA	CON LLAVE C/CONT. DE EMI:
		TPG-14003	TENSOR ARBOL DE LEVAS				TPG-14003	TENSOR ARBOL DE LEVAS	
		38200	TENSOR MICRO-V				38200	TENSOR MICRO-V	
		13346	TERMOSTATO	160°F			13346	TERMOSTATO	160°F
4 CIL, 1.6 L	2006	T203	BANDA ARBOL DE LEVAS	ALT. S/AA	4 CIL, 1.6 L	2002	T203	BANDA ARBOL DE LEVAS	ALT. S/AA
		6362GS	BANDA V				6362GS	BANDA V	
		TCK203	KIT DE DISTRIBUCION				TCK203	KIT DE DISTRIBUCION	
		CH-140253	MANG. B.A.				CH-140253	MANG. B.A.	
		CH-140184	MANG. DE CALEF. ENTRADA				CH-140184	MANG. DE CALEF. ENTRADA	
		CH-140482	MANG. INF.				CH-140482	MANG. INF.	
		CH-140471	MANG. SUP.	C/AA			CH-140471	MANG. SUP.	C/AA
		CH-140451	MANG. SUP.	S/AA			CH-140451	MANG. SUP.	S/AA
		CH-140187	MANG. TANQUE DE RECUP.				CH-140187	MANG. TANQUE DE RECUP.	
		CH-149203	MANGUERA DE PASO				T36038	POLEA LOCA	
		36152	POLEA DEL TENSOR				K060705	SERPENTIN	C/AA
		T36038	POLEA LOCA				K060570	SERPENTIN	S/AA
		K060570	SERPENTIN	S/AA			31778	TAPON DE GASOLINA	CON LLAVE REGULAR
		K060708	SERPENTIN	C/AA			31734	TAPON DE GASOLINA	CON LLAVE C/CONT. DE EMI:
		31734	TAPON DE GASOLINA	CON LLAVE C/CONT. DE EMI:			TPG-14003	TENSOR ARBOL DE LEVAS	
		31778	TAPON DE GASOLINA	CON LLAVE REGULAR			38200	TENSOR MICRO-V	
		TPG-14003	TENSOR ARBOL DE LEVAS				13346	TERMOSTATO	160°F
		38200	TENSOR MICRO-V				T203	BANDA ARBOL DE LEVAS	ALT. S/AA
		13346	TERMOSTATO	160°F	4 CIL, 1.6 L	2001	6362GS	BANDA V	
4 CIL, 1.6 L	2005	T203	BANDA ARBOL DE LEVAS	ALT. S/AA			TCK203	KIT DE DISTRIBUCION	
		6362GS	BANDA V				CH-140253	MANG. B.A.	
		TCK203	KIT DE DISTRIBUCION				CH-140184	MANG. DE CALEF. ENTRADA	
		CH-140253	MANG. B.A.				CH-140482	MANG. INF.	
		CH-140184	MANG. DE CALEF. ENTRADA				CH-140451	MANG. SUP.	S/AA
		CH-140482	MANG. INF.				CH-140471	MANG. SUP.	C/AA
		CH-140471	MANG. SUP.	C/AA			CH-140187	MANG. TANQUE DE RECUP.	
		CH-140451	MANG. SUP.	S/AA			T36038	POLEA LOCA	
		CH-140187	MANG. TANQUE DE RECUP.				K060705	SERPENTIN	C/AA
		CH-149203	MANGUERA DE PASO				K060570	SERPENTIN	S/AA
		36152	POLEA DEL TENSOR				31778	TAPON DE GASOLINA	CON LLAVE REGULAR
		T36038	POLEA LOCA				31734	TAPON DE GASOLINA	CON LLAVE C/CONT. DE EMI:
		K060708	SERPENTIN	C/AA			TPG-14003	TENSOR ARBOL DE LEVAS	
		K060570	SERPENTIN	S/AA			38200	TENSOR MICRO-V	
		31734	TAPON DE GASOLINA	CON LLAVE C/CONT. DE EMI:			13346	TERMOSTATO	160°F
		31778	TAPON DE GASOLINA	CON LLAVE REGULAR	4 CIL, 1.6 L	2000	T203	BANDA ARBOL DE LEVAS	ALT. S/AA
		TPG-14003	TENSOR ARBOL DE LEVAS				6362GS	BANDA V	
		38200	TENSOR MICRO-V				TCK203	KIT DE DISTRIBUCION	
		13346	TERMOSTATO	160°F			CH-140253	MANG. B.A.	
4 CIL, 1.6 L	2004	T203	BANDA ARBOL DE LEVAS	ALT. S/AA			CH-140184	MANG. DE CALEF. ENTRADA	
		6362GS	BANDA V				CH-140482	MANG. INF.	
		TCK203	KIT DE DISTRIBUCION				CH-140451	MANG. SUP.	S/AA
		CH-140253	MANG. B.A.				CH-140471	MANG. SUP.	C/AA
		CH-140184	MANG. DE CALEF. ENTRADA				CH-140187	MANG. TANQUE DE RECUP.	
		CH-140482	MANG. INF.				T36038	POLEA LOCA	
		CH-140471	MANG. SUP.	C/AA			K060570	SERPENTIN	S/AA
		CH-140451	MANG. SUP.	S/AA			K060705	SERPENTIN	C/AA
		CH-140187	MANG. TANQUE DE RECUP.				31778	TAPON DE GASOLINA	CON LLAVE REGULAR
		CH-149203	MANGUERA DE PASO				31734	TAPON DE GASOLINA	CON LLAVE C/CONT. DE EMI:
		36152	POLEA DEL TENSOR				TPG-14003	TENSOR ARBOL DE LEVAS	
		T36038	POLEA LOCA				38200	TENSOR MICRO-V	
		K060708	SERPENTIN	C/AA			13346	TERMOSTATO	160°F
		K060570	SERPENTIN	S/AA			T203	BANDA ARBOL DE LEVAS	ALT. S/AA
		31734	TAPON DE GASOLINA	CON LLAVE C/CONT. DE EMI:	4 CIL, 1.6 L	1999	6362GS	BANDA V	
		TPG-14003	TENSOR ARBOL DE LEVAS				TCK203	KIT DE DISTRIBUCION	
		38200	TENSOR MICRO-V						

    				    						
4 CIL, 1.6 L	1999	CH-140253	MANG. B.A.		6362GS	2004	BANDA V		ALT. S/AA	
		CH-140184	MANG. DE CALEF. ENTRADA				TCK203	KIT DE DISTRIBUCION		
		CH-140482	MANG. INF.				CH-140253	MANG. B.A.		
		CH-140471	MANG. SUP.	C/AA			CH-140184	MANG. DE CALEF. ENTRADA		
		CH-140451	MANG. SUP.	S/AA			CH-140482	MANG. INF.		
		CH-140187	MANG. TANQUE DE RECUP.				CH-140451	MANG. SUP.	S/AA	
		T36038	POLEA LOCA				CH-140471	MANG. SUP.	C/AA	
		K060570	SERPENTIN	S/AA			CH-140187	MANG. TANQUE DE RECUP.		
		K060705	SERPENTIN	C/AA			CH-149203	MANGUERA DE PASO		
		31778	TAPON DE GASOLINA	CON LLAVE REGULAR			36152	POLEA DEL TENSOR		
		31734	TAPON DE GASOLINA	CON LLAVE C/CONT. DE EMI:			T36038	POLEA LOCA		
		TPG-14003	SENSOR ARBOL DE LEVAS				K060708	SERPENTIN	C/AA	
		38200	SENSOR MICRO-V				K060570	SERPENTIN	S/AA	
		13346	TERMOSTATO	160°F			31778	TAPON DE GASOLINA	CON LLAVE C/CONT. DE EMI:	
		4 CIL, 1.6 L	1998	T203			BANDA ARBOL DE LEVAS		4 CIL, 1.6 L	2004
6362GS	BANDA V			ALT. S/AA	6362GS	BANDA V				
TCK203	KIT DE DISTRIBUCION				TCK203	KIT DE DISTRIBUCION				
CH-140253	MANG. B.A.				CH-140253	MANG. B.A.				
CH-140184	MANG. DE CALEF. ENTRADA				CH-140184	MANG. DE CALEF. ENTRADA				
CH-140482	MANG. INF.				CH-140482	MANG. INF.				
CH-140471	MANG. SUP.			C/AA	CH-140451	MANG. SUP.	S/AA			
CH-140451	MANG. SUP.			S/AA	CH-140471	MANG. SUP.	C/AA			
CH-140187	MANG. TANQUE DE RECUP.				CH-140187	MANG. TANQUE DE RECUP.				
CH-149203	MANGUERA DE PASO				CH-149203	MANGUERA DE PASO				
36152	POLEA DEL TENSOR				36152	POLEA DEL TENSOR				
T36038	POLEA LOCA				T36038	POLEA LOCA				
K060570	SERPENTIN			S/AA	K060708	SERPENTIN	C/AA			
K060705	SERPENTIN			C/AA	K060570	SERPENTIN	S/AA			
31734	TAPON DE GASOLINA			CON LLAVE C/CONT. DE EMI:	31734	TAPON DE GASOLINA	CON LLAVE C/CONT. DE EMI:			
31778	TAPON DE GASOLINA	CON LLAVE REGULAR	31778	TAPON DE GASOLINA	CON LLAVE REGULAR					
TPG-14003	SENSOR ARBOL DE LEVAS		TPG-14003	SENSOR ARBOL DE LEVAS						
38200	SENSOR MICRO-V		38200	SENSOR MICRO-V						
13346	TERMOSTATO	160°F	13346	TERMOSTATO	160°F					
4 CIL, 1.6 L	1997	T203	BANDA ARBOL DE LEVAS		4 CIL, 1.6 L	2003	T203	BANDA ARBOL DE LEVAS	{110 D x 22 mm}	
		6362GS	BANDA V	ALT. S/AA			6362GS	BANDA V		
		TCK203	KIT DE DISTRIBUCION				TCK203	KIT DE DISTRIBUCION		
		CH-140253	MANG. B.A.				CH-140253	MANG. B.A.		
		CH-140184	MANG. DE CALEF. ENTRADA				CH-140184	MANG. DE CALEF. ENTRADA		
		CH-140482	MANG. INF.				CH-140482	MANG. INF.		
		CH-140471	MANG. SUP.	C/AA			CH-140471	MANG. SUP.	C/AA	
		CH-140451	MANG. SUP.	S/AA			CH-140451	MANG. SUP.	S/AA	
		CH-140187	MANG. TANQUE DE RECUP.				CH-140187	MANG. TANQUE DE RECUP.		
		CH-149203	MANGUERA DE PASO				CH-149203	MANGUERA DE PASO		
		36152	POLEA DEL TENSOR				36152	POLEA DEL TENSOR		
		T36038	POLEA LOCA				T36038	POLEA LOCA		
		K060570	SERPENTIN	S/AA			K060705	SERPENTIN	C/AA	
		K060705	SERPENTIN	C/AA			K060570	SERPENTIN	S/AA	
		31778	TAPON DE GASOLINA	CON LLAVE REGULAR			31734	TAPON DE GASOLINA	CON LLAVE C/CONT. DE EMI:	
31734	TAPON DE GASOLINA	CON LLAVE C/CONT. DE EMI:	31778	TAPON DE GASOLINA	CON LLAVE REGULAR					
TPG-14003	SENSOR ARBOL DE LEVAS		TPG-14003	SENSOR ARBOL DE LEVAS						
38200	SENSOR MICRO-V		38200	SENSOR MICRO-V						
13346	TERMOSTATO	160°F	13346	TERMOSTATO	160°F					
4 CIL, 1.6 L	2006	T203	BANDA ARBOL DE LEVAS		4 CIL, 1.6 L	2002	T203	BANDA ARBOL DE LEVAS	160°F	
		6362GS	BANDA V	ALT. S/AA			6362GS	BANDA V	ALT. S/AA	
		TCK203	KIT DE DISTRIBUCION				TCK203	KIT DE DISTRIBUCION		
		CH-140253	MANG. B.A.				CH-140253	MANG. B.A.		
		CH-140184	MANG. DE CALEF. ENTRADA				CH-140184	MANG. DE CALEF. ENTRADA		
		CH-140482	MANG. INF.				CH-140482	MANG. INF.		
		CH-140471	MANG. SUP.	C/AA			CH-140471	MANG. SUP.	C/AA	
		CH-140451	MANG. SUP.	S/AA			CH-140451	MANG. SUP.	S/AA	
		CH-140187	MANG. TANQUE DE RECUP.				CH-140187	MANG. TANQUE DE RECUP.		
		CH-149203	MANGUERA DE PASO				CH-149203	MANGUERA DE PASO		
		36152	POLEA DEL TENSOR				36152	POLEA DEL TENSOR		
		T36038	POLEA LOCA				T36038	POLEA LOCA		
		K060570	SERPENTIN	S/AA			K060705	SERPENTIN	C/AA	
		K060708	SERPENTIN	C/AA			K060570	SERPENTIN	S/AA	
		31734	TAPON DE GASOLINA	CON LLAVE C/CONT. DE EMI:			31778	TAPON DE GASOLINA	CON LLAVE REGULAR	
31778	TAPON DE GASOLINA	CON LLAVE REGULAR	31734	TAPON DE GASOLINA	CON LLAVE C/CONT. DE EMI:					
TPG-14003	SENSOR ARBOL DE LEVAS		TPG-14003	SENSOR ARBOL DE LEVAS						
38200	SENSOR MICRO-V		38200	SENSOR MICRO-V						
13346	TERMOSTATO	160°F	13346	TERMOSTATO	160°F					
4 CIL, 1.6 L	2005	T203	BANDA ARBOL DE LEVAS		4 CIL, 1.6 L	2005	T203	BANDA ARBOL DE LEVAS	160°F	

**CHEVY PICK-UP**













**CHEVY POP**

4 CIL, 1.6 L	2003	T203	BANDA ARBOL DE LEVAS	ALT. S/AA	4 CIL, 1.6 L	
		6362GS	BANDA V			
		TCK203	KIT DE DISTRIBUCION			
		CH-140253	MANG. B.A.			
		CH-140184	MANG. DE CALEF. ENTRADA			
		CH-140482	MANG. INF.			
		CH-140451	MANG. SUP.			S/AA
		CH-140471	MANG. SUP.			C/AA
		CH-140187	MANG. TANQUE DE RECUP.			
		CH-149203	MANGUERA DE PASO			
		36152	POLEA DEL TENSOR			
		T36038	POLEA LOCA			
		K060708	SERPENTIN			C/AA
		K060570	SERPENTIN			S/AA
		31734	TAPON DE GASOLINA			CON LLAVE C/CONT. DE EMI:
31778	TAPON DE GASOLINA	CON LLAVE REGULAR				
TPG-14003	SENSOR ARBOL DE LEVAS	160°F				
38200	SENSOR MICRO-V					
13346	TERMOSTATO					
4 CIL, 1.6 L	2002	T203	BANDA ARBOL DE LEVAS	ALT. S/AA	4 CIL, 1.6 L	
		6362GS	BANDA V			
		TCK203	KIT DE DISTRIBUCION			
		CH-140253	MANG. B.A.			
		CH-140184	MANG. DE CALEF. ENTRADA			
		CH-140482	MANG. INF.			
		CH-140451	MANG. SUP.			S/AA
		CH-140471	MANG. SUP.			C/AA
		CH-140187	MANG. TANQUE DE RECUP.			
		CH-149203	MANGUERA DE PASO			
		36152	POLEA DEL TENSOR			
		T36038	POLEA LOCA			
		K060708	SERPENTIN			C/AA
		K060570	SERPENTIN			S/AA
		31778	TAPON DE GASOLINA			CON LLAVE REGULAR
31734	TAPON DE GASOLINA	CON LLAVE C/CONT. DE EMI:				
TPG-14003	SENSOR ARBOL DE LEVAS	160°F				
38200	SENSOR MICRO-V					
13346	TERMOSTATO					
4 CIL, 1.6 L	2001	T203	BANDA ARBOL DE LEVAS	ALT. S/AA	4 CIL, 1.6 L	
		6362GS	BANDA V			
		TCK203	KIT DE DISTRIBUCION			
		CH-140253	MANG. B.A.			
		CH-140184	MANG. DE CALEF. ENTRADA			
		CH-140482	MANG. INF.			
		CH-140451	MANG. SUP.			S/AA
		CH-140471	MANG. SUP.			C/AA
		CH-140187	MANG. TANQUE DE RECUP.			
		CH-149203	MANGUERA DE PASO			
		36152	POLEA DEL TENSOR			
		T36038	POLEA LOCA			
		K060708	SERPENTIN			C/AA
		K060570	SERPENTIN			S/AA
		31734	TAPON DE GASOLINA			CON LLAVE C/CONT. DE EMI:
31778	TAPON DE GASOLINA	CON LLAVE REGULAR				
TPG-14003	SENSOR ARBOL DE LEVAS	160°F				
38200	SENSOR MICRO-V					
13346	TERMOSTATO					
4 CIL, 1.6 L	2000	T203	BANDA ARBOL DE LEVAS	ALT. S/AA	4 CIL, 1.6 L	
		6362GS	BANDA V			
		TCK203	KIT DE DISTRIBUCION			
		CH-140253	MANG. B.A.			
		CH-140184	MANG. DE CALEF. ENTRADA			
		CH-140482	MANG. INF.			
		CH-140451	MANG. SUP.			S/AA
		CH-140471	MANG. SUP.			C/AA
		CH-140187	MANG. TANQUE DE RECUP.			
		CH-149203	MANGUERA DE PASO			
		36152	POLEA DEL TENSOR			
		T36038	POLEA LOCA			
		K060708	SERPENTIN			C/AA
		K060570	SERPENTIN			S/AA
		31734	TAPON DE GASOLINA			CON LLAVE C/CONT. DE EMI:

**CHEVY SWING**

4 CIL, 1.6 L	2003	T203	BANDA ARBOL DE LEVAS	ALT. S/AA	
		6362GS	BANDA V		
		TCK203	KIT DE DISTRIBUCION		
		CH-140253	MANG. B.A.		
		CH-140184	MANG. DE CALEF. ENTRADA		
		CH-140482	MANG. INF.		
		CH-140451	MANG. SUP.		S/AA
		CH-140471	MANG. SUP.		C/AA
		CH-140187	MANG. TANQUE DE RECUP.		
		CH-149203	MANGUERA DE PASO		
		36152	POLEA DEL TENSOR		
		31778	TAPON DE GASOLINA		CON LLAVE REGULAR
		31734	TAPON DE GASOLINA		CON LLAVE C/CONT. DE EMI:
		TPG-14003	SENSOR ARBOL DE LEVAS		160°F
		38200	SENSOR MICRO-V		
13346	TERMOSTATO				

    				    					
4 CIL, 1.6 L	2003	T36038 K060705 K060570 31734 31778 TPG-14003 38200 13346	POLEA LOCA SERPENTIN SERPENTIN TAPON DE GASOLINA TAPON DE GASOLINA TENSOR ARBOL DE LEVAS TENSOR MICRO-V TERMOSTATO	C/AA S/AA CON LLAVE C/CONT. DE EMI: CON LLAVE REGULAR 160°F		36152 T36038 K060705 K060570 31778 31734 TPG-14003 38200 13346	POLEA DEL TENSOR POLEA LOCA SERPENTIN SERPENTIN TAPON DE GASOLINA TAPON DE GASOLINA TENSOR ARBOL DE LEVAS TENSOR MICRO-V TERMOSTATO	C/AA S/AA CON LLAVE REGULAR CON LLAVE C/CONT. DE EMI: 160°F	
4 CIL, 1.6 L	2002	6362GS TCK203 CH-140253 CH-140184 CH-140482 CH-140451 CH-140471 CH-140187 CH-149203 36152 T36038 K060705 K060570 31778 31734 TPG-14003 38200 13346	BANDA ARBOL DE LEVAS BANDA V KIT DE DISTRIBUCION MANG. B.A. MANG. DE CALEF. ENTRADA MANG. INF. MANG. SUP. MANG. SUP. MANG. TANQUE DE RECUP. MANGUERA DE PASO POLEA DEL TENSOR POLEA LOCA SERPENTIN SERPENTIN TAPON DE GASOLINA TAPON DE GASOLINA TENSOR ARBOL DE LEVAS TENSOR MICRO-V TERMOSTATO	ALT. S/AA S/AA C/AA 160°F	4 CIL, 1.6 L	1998	T203 6362GS TCK203 CH-140253 CH-140184 CH-140482 CH-140451 CH-140471 CH-140187 CH-149203 36152 T36038 K060705 K060570 31778 31734 TPG-14003 38200 13346	BANDA ARBOL DE LEVAS BANDA V KIT DE DISTRIBUCION MANG. B.A. MANG. DE CALEF. ENTRADA MANG. INF. MANG. SUP. MANG. SUP. MANG. TANQUE DE RECUP. MANGUERA DE PASO POLEA DEL TENSOR POLEA LOCA SERPENTIN SERPENTIN TAPON DE GASOLINA TAPON DE GASOLINA TENSOR ARBOL DE LEVAS TENSOR MICRO-V TERMOSTATO	ALT. S/AA S/AA C/AA 160°F
4 CIL, 1.6 L	2001	6362GS TCK203 CH-140253 CH-140184 CH-140482 CH-140451 CH-140471 CH-140187 CH-149203 36152 T36038 K060705 K060570 31778 31734 TPG-14003 38200 13346	BANDA ARBOL DE LEVAS BANDA V KIT DE DISTRIBUCION MANG. B.A. MANG. DE CALEF. ENTRADA MANG. INF. MANG. SUP. MANG. SUP. MANG. TANQUE DE RECUP. MANGUERA DE PASO POLEA DEL TENSOR POLEA LOCA SERPENTIN SERPENTIN TAPON DE GASOLINA TAPON DE GASOLINA TENSOR ARBOL DE LEVAS TENSOR MICRO-V TERMOSTATO	ALT. S/AA S/AA C/AA 160°F	4 CIL, 1.6 L	1997	T203 6362GS TCK203 CH-140253 CH-140184 CH-140482 CH-140451 CH-140471 CH-140187 CH-149203 36152 T36038 K060705 K060570 31778 31734 TPG-14003 38200 13346	BANDA ARBOL DE LEVAS BANDA V KIT DE DISTRIBUCION MANG. B.A. MANG. DE CALEF. ENTRADA MANG. INF. MANG. SUP. MANG. SUP. MANG. TANQUE DE RECUP. MANGUERA DE PASO POLEA DEL TENSOR POLEA LOCA SERPENTIN SERPENTIN TAPON DE GASOLINA TAPON DE GASOLINA TENSOR ARBOL DE LEVAS TENSOR MICRO-V TERMOSTATO	ALT. S/AA S/AA C/AA 160°F
4 CIL, 1.6 L	2000	T203 6362GS TCK203 CH-140253 CH-140184 CH-140482 CH-140451 CH-140471 CH-140187 CH-149203 36152 T36038 K060705 K060570 31734 31778 TPG-14003 38200 13346	BANDA ARBOL DE LEVAS BANDA V KIT DE DISTRIBUCION MANG. B.A. MANG. DE CALEF. ENTRADA MANG. INF. MANG. SUP. MANG. SUP. MANG. TANQUE DE RECUP. MANGUERA DE PASO POLEA DEL TENSOR POLEA LOCA SERPENTIN SERPENTIN TAPON DE GASOLINA TAPON DE GASOLINA TENSOR ARBOL DE LEVAS TENSOR MICRO-V TERMOSTATO	ALT. S/AA C/AA S/AA 160°F			1925 CH-146572 CH-140441 K060960 K060966 K060870 K060875 19025 CH-146572 CH-140441 K060966 K061145 K060960 K060870 K060875 19025 CH-146572 CH-140441 K060966 K060870 K060875 19025 CH-146572 CH-140441 K060966 K060870 K060875	MANGUERA DE PASO MANGUERA INF. MANGUERA SUP. SERPENTIN SERPENTIN SERPENTIN SERPENTIN SERPENTIN MANGUERA DE PASO MANGUERA INF. MANGUERA SUP. SERPENTIN SERPENTIN SERPENTIN SERPENTIN SERPENTIN MANGUERA DE PASO MANGUERA INF. MANGUERA SUP. SERPENTIN SERPENTIN SERPENTIN SERPENTIN SERPENTIN MANGUERA DE PASO MANGUERA INF. MANGUERA SUP. SERPENTIN	C/AA, 100 AMP C/AA, 140 AMP S/AA, 100 AMP S/AA, 140 AMP C/AA, 140 AMP C/AA, C/BH, 140 AMP C/AA, 100 AMP S/AA, 100 AMP S/AA, 140 AMP C/AA, 140 AMP C/AA, 100 AMP S/AA, 100 AMP S/AA, 140 AMP C/AA, 100 AMP
4 CIL, 1.6 L	1999	T203 6362GS TCK203 CH-140253 CH-140184 CH-140482 CH-140451 CH-140471 CH-140187 CH-149203 36152 T36038 K060705 K060570 31734 31778 TPG-14003 38200 13346	BANDA ARBOL DE LEVAS BANDA V KIT DE DISTRIBUCION MANG. B.A. MANG. DE CALEF. ENTRADA MANG. INF. MANG. SUP. MANG. SUP. MANG. TANQUE DE RECUP. MANGUERA DE PASO POLEA DEL TENSOR POLEA LOCA SERPENTIN SERPENTIN TAPON DE GASOLINA TAPON DE GASOLINA TENSOR ARBOL DE LEVAS TENSOR MICRO-V TERMOSTATO	ALT. S/AA C/AA S/AA 160°F	V-8, 5.7 L	1998	19025 CH-146572 CH-140441 K060966 K060870 K060875 19025 CH-146572 CH-140441 K060966 K060870 K060875	MANGUERA DE PASO MANGUERA INF. MANGUERA SUP. SERPENTIN SERPENTIN SERPENTIN SERPENTIN MANGUERA DE PASO MANGUERA INF. MANGUERA SUP. SERPENTIN SERPENTIN SERPENTIN SERPENTIN MANGUERA DE PASO MANGUERA INF. MANGUERA SUP. SERPENTIN	C/AA, 140 AMP C/AA, 100 AMP S/AA, 100 AMP S/AA, 140 AMP C/AA, 140 AMP C/AA, 100 AMP S/AA, 100 AMP S/AA, 140 AMP C/AA, 100 AMP
4 CIL, 1.6 L	1999	T203 6362GS TCK203 CH-140253 CH-140184 CH-140482 CH-140451 CH-140471 CH-140187 CH-149203	BANDA ARBOL DE LEVAS BANDA V KIT DE DISTRIBUCION MANG. B.A. MANG. DE CALEF. ENTRADA MANG. INF. MANG. SUP. MANG. SUP. MANG. TANQUE DE RECUP. MANGUERA DE PASO	ALT. S/AA C/AA S/AA	V-8, 5.7 L	1997	19025 CH-146572 CH-140441 K060966 K060870 K060875	MANGUERA DE PASO MANGUERA INF. MANGUERA SUP. SERPENTIN SERPENTIN SERPENTIN SERPENTIN MANGUERA DE PASO MANGUERA INF. MANGUERA SUP. SERPENTIN	C/AA, 140 AMP C/AA, 100 AMP S/AA, 100 AMP S/AA, 140 AMP C/AA, 100 AMP

**CHEYENNE**



V-8, 5.7 L	1997	K060966 K060870 K060875	SERPENTIN SERPENTIN SERPENTIN	C/AA, 140 AMP S/AA, 100 AMP S/AA, 140 AMP

5 CIL, 3.7 L				

**COLORADO**











4 CIL, 2.9 L	2010	22908 22907 36101 36301 K060915 31103 31844 31843 31532 38178	MANGUERA INF. MANGUERA SUP. POLEA POLEA DEL TENSOR SERPENTIN TAPON DE ACEITE TAPON DE GASOLINA TAPON DE GASOLINA TAPONES DE RADIADOR TENSOR	CON LLAVE 15 LBS.	4 CIL, 2.8 L		
5 CIL, 3.7 L	2010	22917 22129 36101 36301 K060915 31103 31844 31843 31532 38178	MANGUERA INF. MANGUERA SUP. POLEA POLEA DEL TENSOR SERPENTIN TAPON DE ACEITE TAPON DE GASOLINA TAPON DE GASOLINA TAPONES DE RADIADOR TENSOR	CON LLAVE 15 LBS.	5 CIL, 3.5 L		
4 CIL, 2.9 L	2009	22908 22907 36301 36101 K060915 31103 31844 31843 31532 38178	MANGUERA INF. MANGUERA SUP. POLEA POLEA DEL TENSOR SERPENTIN TAPON DE ACEITE TAPON DE GASOLINA TAPON DE GASOLINA TAPONES DE RADIADOR TENSOR	CON LLAVE 15 LBS.	4 CIL, 2.8 L		
5 CIL, 3.7 L	2009	22917 22129 36301 36101 K060915 31103 31843 31844 31532 38178	MANGUERA INF. MANGUERA SUP. POLEA POLEA DEL TENSOR SERPENTIN TAPON DE ACEITE TAPON DE GASOLINA TAPON DE GASOLINA TAPONES DE RADIADOR TENSOR	CON LLAVE 15 LBS.	5 CIL, 3.5 L		
4 CIL, 2.9 L	2008	22908 22907 36301 36101 K060915 31103 31843 31844 31532 38178	MANGUERA INF. MANGUERA SUP. POLEA POLEA DEL TENSOR SERPENTIN TAPON DE ACEITE TAPON DE GASOLINA TAPON DE GASOLINA TAPONES DE RADIADOR TENSOR	CON LLAVE 15 LBS.	5 CIL, 3.5 L		
5 CIL, 3.7 L	2008	22917 22129 36301 36101 K060915 31103 31843 31844 31532 38178	MANGUERA INF. MANGUERA SUP. POLEA POLEA DEL TENSOR SERPENTIN TAPON DE ACEITE TAPON DE GASOLINA TAPON DE GASOLINA TAPONES DE RADIADOR TENSOR	CON LLAVE 15 LBS.			
4 CIL, 2.9 L	2007	22908 22907 36101 K060915 31103 31843 31532 38178 34045	MANG. INF. MANG. SUP. POLEA SERPENTIN TAPON DE ACEITE TAPON DE GASOLINA TAPON DE RADIADOR TENSOR MICRO-V TERMOSTATO	SIN LLAVE REGULAR (15 lbs) Sin palanca 180°F			

		22917 22129 36101 K060915 31103 31843 31532 38178 34045	MANG. INF. MANG. SUP. POLEA SERPENTIN TAPON DE ACEITE TAPON DE GASOLINA TAPON DE RADIADOR TENSOR MICRO-V TERMOSTATO				SIN LLAVE REGULAR (15 lbs) Sin palanca 180°F
	2006	22908 22907 38018 36101 K060915 K060690 31103 31843 31532 38178	MANG. INF. MANG. SUP. POLEA POLEA SERPENTIN SERPENTIN TAPON DE ACEITE TAPON DE GASOLINA TAPON DE RADIADOR TENSOR MICRO-V				C/AA S/AA SIN LLAVE REGULAR (15 lbs) Sin palanca
	2006	22917 22129 38018 36101 K060915 K060690 31103 31843 31532 38178	MANG. INF. MANG. SUP. POLEA POLEA SERPENTIN SERPENTIN TAPON DE ACEITE TAPON DE GASOLINA TAPON DE RADIADOR TENSOR MICRO-V				CORTAR A MEDIDA C/AA S/AA SIN LLAVE REGULAR (15 lbs) Sin palanca
	2005	35B 3/8" 22907 38018 36101 K060915 K060690 31103 31843 31532 38178	MANGUERA DE CALEF. MANGUERA SUP. POLEA POLEA SERPENTIN SERPENTIN TAPON DE ACEITE TAPON DE GASOLINA TAPON DE RADIADOR TENSOR MICRO-V				RAD A TANQUE DE RECUPEI SIN LLAVE REGULAR (15 lbs) Sin palanca
	2005	35B 3/8" 22129 38018 36101 K060915 K060690 31103 31843 31532 38178	MANGUERA DE CALEF. MANGUERA SUP. POLEA POLEA SERPENTIN SERPENTIN TAPON DE ACEITE TAPON DE GASOLINA TAPON DE RADIADOR TENSOR MICRO-V				RAD A TANQUE DE RECUPEI SIN LLAVE REGULAR (15 lbs) Sin palanca
	2004	36101 38018 35B 3/8" K060915 K060690 31103 31843 31532 38178	POLEA POLEA DEL TENSOR RADIADOR A TANQ. DE RECUP. SERPENTIN SERPENTIN TAPON DE ACEITE TAPON DE GASOLINA TAPON DE RADIADOR TENSOR MICRO-V				SIN LLAVE REGULAR (15 lbs) Sin palanca

**CORSA**

4 CIL, 1.8 L	2009	T203 CH-140222 CH-140201 K050690 K050715 TMV-14001 TPG-14004	BANDA ARBOL DE LEVAS MANGUERA INF. MANGUERA SUP. SERPENTIN SERPENTIN TENSOR TENSOR	111 D X 17.0 mm SIN A.A. CON A.A.
4 CIL, 1.8 L	2008	T203 CH-140222 CH-140201 K050715 K050690 TPG-14004	BANDA ARBOL DE LEVAS MANG. INF. MANG. SUP. SERPENTIN SERPENTIN TENSOR ARBOL DE LEVAS	C/AA S/AA

















									
4 CIL, 1.8 L	2008	TMV-14001	SENSOR MICRO-V		V-8, 5.7 L	2004	80230	EDH	PRESION
4 CIL, 1.8 L	2007	T203	BANDA ARBOL DE LEVAS				22405	MANGUERA INF.	
		CH-140222	MANG. INF.				22404	MANGUERA SUP.	
		CH-140201	MANG. SUP.				38008	POLEA	SERPENTIN
		K050715	SERPENTIN	C/AA			38006	POLEA LOCA	
		K050690	SERPENTIN	S/AA			35B 3/8"	RADIADOR A TANQ.DE REC.	
		TPG-14004	SENSOR ARBOL DE LEVAS				18127	RADIADOR A VALV. REG. AIRE	
4 CIL, 1.8 L	2006	TMV-14001	SENSOR MICRO-V				35B 3/4"	RADIADOR SURGE TANK OUTLI	A.A.
		T203	BANDA ARBOL DE LEVAS				K040420	SERPENTIN	
		CH-140222	MANG. INF.				K060802	SERPENTIN	
		CH-140201	MANG. SUP.				31103	TAPON DE ACEITE	
		K050690	SERPENTIN	S/AA			31636	TAPON DE GASOLINA	SIN LLAVE REGULAR
		K050715	SERPENTIN	C/AA			31544	TAPON DE RADIADOR	(18 lbs) Sin Palanca
		TPG-14004	SENSOR ARBOL DE LEVAS				38194	SENSOR MICRO-V	SERPENTIN
4 CIL, 1.8 L	2005	TMV-14001	SENSOR MICRO-V				38196	SENSOR MICRO-V	A.A.
		T203	BANDA ARBOL DE LEVAS				33963	TERMOSTATO	186°F
		CH-140222	MANGUERA INF.				35B 5/8"	TUBO 1 A VÁLVULA; SUP.	
		CH-140201	MANGUERA SUP.				18447	TUBO 2 A B.A.; INF.	
		K050715	SERPENTIN	C/AA			35B 1/4"	VALV. REG. DE AIRE A REFRIG.	
		K050690	SERPENTIN	S/AA	V-8, 5.7 L	2003	K040420	A.A.	PRESION
		TPG-14004	SENSOR ARBOL DE LEVAS				80230	EDH	
4 CIL, 1.8 L	2004	TMV-14001	SENSOR MICRO-V				22405	MANGUERA INF.	
		T203	BANDA ARBOL DE LEVAS				22404	MANGUERA SUP.	
		CH-140222	MANGUERA INF.				38008	POLEA DEL TENSOR	
		CH-140201	MANGUERA SUP.				38006	POLEA LOCA	
		K050715	SERPENTIN	C/AA			18127	RADIADOR A VALV. REG. AIRE	
		K050370	SERPENTIN	S/AA			30T 3/4"	RADIADOR SURGE TANK OUTLI	
		TPG-14004	SENSOR ARBOL DE LEVAS				35B 3/8"	RECUPERADOR	
4 CIL, 1.8 L	2003	TMV-14001	SENSOR MICRO-V				K060802	SERPENTIN	
		T203	BANDA ARBOL DE LEVAS				31103	TAPON DE ACEITE	
		CH-140222	MANGUERA INF.				31636	TAPON DE GASOLINA	SIN LLAVE REGULAR
		CH-140201	MANGUERA SUP.				38194	SENSOR MICRO-V	ACCESORIO
		K050715	SERPENTIN	C/AA			38196	SENSOR MICRO-V	A.A.
		K050370	SERPENTIN	S/AA			33910	TERMOSTATO	180°F
		TPG-14004	SENSOR ARBOL DE LEVAS				30T 5/8"	TUBO-1 A VALVULA	Top
4 CIL, 1.4 L	2003	TMV-14001	SENSOR MICRO-V				18447	TUBO-2 A B.A.	PARTE INFERIOR
		T1094	BANDA ARBOL DE LEVAS	162 D X 20 mm			35B 1/4"	VALV. REG. DE AIRE A REFRIG.	
		TCK1094	KIT DE DISTRIBUCION		V-8, 5.7 L	2002	K040420	A.A.	
		K050370	SERPENTIN	SIN A.A.			80230	EDH	PRESION
		K050478	SERPENTIN	CON A.A.			22405	MANGUERA INF.	
		TPG-14004	SENSOR				22404	MANGUERA SUP.	
4 CIL, 1.4 L	2002	TMV-14001	SENSOR				38008	POLEA DEL TENSOR	
		T1094	BANDA ARBOL DE LEVAS				38006	POLEA LOCA	
		TPG-14004	SENSOR ARBOL DE LEVAS				18127	RADIADOR A VALV. REG. AIRE	
4 CIL, 1.4 L	2002	TCK1094	KIT DE DISTRIBUCION				30T 3/4"	RADIADOR SURGE TANK OUTLI	
		K050478	SERPENTIN	CON A.A.			35B 3/8"	RECUPERADOR	
		K050370	SERPENTIN	SIN A.A.			K060802	SERPENTIN	
		TMV-14001	SENSOR				31103	TAPON DE ACEITE	
							31636	TAPON DE GASOLINA	SIN LLAVE REGULAR
							38196	SENSOR MICRO-V	A.A.
							38194	SENSOR MICRO-V	ACCESORIO
							33910	TERMOSTATO	180°F
							30T 5/8"	TUBO-1 A VALVULA	Top
							18447	TUBO-2 A B.A.	PARTE INFERIOR
							35B 1/4"	VALV. REG. DE AIRE A REFRIG.	
							K040420	A.A.	
							80230	EDH	PRESION
							22405	MANGUERA INF.	
							22404	MANGUERA SUP.	
							38008	POLEA DEL TENSOR	
							38006	POLEA LOCA	
							18127	RADIADOR A VALV. REG. AIRE	
							30T 3/4"	RADIADOR SURGE TANK OUTLI	
							35B 3/8"	RECUPERADOR	
							K060802	SERPENTIN	
							31103	TAPON DE ACEITE	
							31636	TAPON DE GASOLINA	SIN LLAVE REGULAR
							38196	SENSOR MICRO-V	A.A.
							38194	SENSOR MICRO-V	ACCESORIO
							33910	TERMOSTATO	180°F
							30T 5/8"	TUBO-1 A VALVULA	Top
							18447	TUBO-2 A B.A.	PARTE INFERIOR
							35B 1/4"	VALV. REG. DE AIRE A REFRIG.	
							K040420	A.A.	
							80230	EDH	PRESION
							22405	MANGUERA INF.	
							22404	MANGUERA SUP.	
							38008	POLEA DEL TENSOR	
							38006	POLEA LOCA	
							K060795	SERPENTIN	
							K060795	SERPENTIN	
							K060798	SERPENTIN	
							31103	TAPON DE ACEITE	
							31636	TAPON DE GASOLINA	SIN LLAVE REGULAR
							38196	SENSOR MICRO-V	A.A.
							38194	SENSOR MICRO-V	ACCESORIO
							K040420	A.A.	
							80230	EDH	PRESION
							18125	MANGUERA DE PASO	
							22405	MANGUERA INF.	
							22404	MANGUERA SUP.	
							38008	POLEA DEL TENSOR	
							38006	POLEA LOCA	

**CORVETTE**











V-8, 6.0 L	2007	38009	POLEA	SERPENTIN					
		38008	POLEA	ACCESORIO					
		K060798	SERPENTIN						
		K040398	SERPENTIN	A.A.					
		31103	TAPON DE ACEITE		V-8, 5.7 L	2001	K040420	A.A.	
		31636	TAPON DE GASOLINA	SIN LLAVE REGULAR			80230	EDH	PRESION
		38328	SENSOR MICRO-V	ACCESORIO			22405	MANGUERA INF.	
		33963	TERMOSTATO	186°F			22404	MANGUERA SUP.	
V-8, 6.0 L	2006	38008	POLEA	ACCESORIO			38008	POLEA DEL TENSOR	
		38009	POLEA	SERPENTIN			38006	POLEA LOCA	
		K040398	SERPENTIN	A.A.			K060795	SERPENTIN	
		K060798	SERPENTIN				K060795	SERPENTIN	
		31103	TAPON DE ACEITE				K060798	SERPENTIN	
		31636	TAPON DE GASOLINA	SIN LLAVE REGULAR			31103	TAPON DE ACEITE	
		38328	SENSOR MICRO-V	ACCESORIO			31636	TAPON DE GASOLINA	SIN LLAVE REGULAR
		33963	TERMOSTATO	186°F			38196	SENSOR MICRO-V	A.A.
V-8, 6.0 L	2005	38009	POLEA				38194	SENSOR MICRO-V	ACCESORIO
		38008	POLEA	ACCESORIO	V-8, 5.7 L	2000	K040420	A.A.	
		K040398	SERPENTIN				80230	EDH	PRESION
		K060798	SERPENTIN				18125	MANGUERA DE PASO	
		31103	TAPON DE ACEITE				22405	MANGUERA INF.	
		31636	TAPON DE GASOLINA	SIN LLAVE REGULAR			22404	MANGUERA SUP.	
		38328	SENSOR MICRO-V	ACCESORIO			38008	POLEA DEL TENSOR	
		33963	TERMOSTATO	186°F			38006	POLEA LOCA	













    		    																	
V-8, 5.3 L	2009	23383 MANGUERA SUP. 36299 POLEA 38009 POLEA DEL TENSOR K060930 SERPENTIN K060935 SERPENTIN 31103 TAPON DE ACEITE 31843 TAPON DE GASOLINA 31844 TAPON DE GASOLINA 31532 TAPONES DE RADIADOR 39083 TENSOR 33963 TERMOSTATOS	SERPENTIN C/ALT. 125 A. C/ALT. 145 A.  CON LLAVE 15 LBS. SERPENTIN 186°	V-8, 6.0 L	2007	38159 TENSOR MICRO-V 38158 TENSOR MICRO-V 19729 MANG. CALEF. A TUBO 2 A VALV 28466 MANG. CALEF. A VALVULA 18933 MANG. CALEF. AUX. TUBO 1 A 22756 MANG. INF. 19761 MANG. MOTOR A CALEF. 19665 MANG. MOTOR A CALEF. AUX. 19750 MANG. MOTOR A VALVULA 18129 MANG. RAD. A VALV. REG. DE A 22755 MANG. SUP. 19279 MANG. VALV. A CALEF. A TUBC 19749 MANG. VALVULA A CALEF. 19082 MANG. VALVULA A MOTOR 38001 POLEA 38009 POLEA K060923 SERPENTIN K060930 SERPENTIN K040378 SERPENTIN 31103 TAPON DE ACEITE 31852 TAPON DE GASOLINA 31532 TAPON DE RADIADOR 38159 TENSOR MICRO-V 38158 TENSOR MICRO-V 33963 TERMOSTATO	A.A. SERPENTIN C/AA CORTAR A MEDIDA S/AA, C/AA  S/CALEFACTOR AUX., S/AA S/AA, C/AA S/CALEFACTOR AUX., C/AA  C/AA CORTAR A MEDIDA S/CALEFACTOR AUX., C/AA SERPENTIN SERPENTIN C/ALT 105 A C/ALT 145 A A.A.  SIN LLAVE (15 lbs) Sin palanca A.A. SERPENTIN 186°F  S/CALEFACTOR AUX., S/AA CORTAR A MEDIDA S/AA CORTAR A MEDIDA C/AA  CORTAR A MEDIDA CORTAR A MEDIDA  CORTAR A MEDIDA SERPENTIN SERPENTIN C/ALT 105A C/ALT. 145A A.A.  CON LLAVE REGULAR (15 lbs) Sin palanca SERPENTIN A.A. C/AA S/AA & C/AA CORTAR A MEC C/AA CORTAR A MEDIDA  S/AA S/AA CORTAR A MEDIDA CORTAR A MEDIDA  C/AA CORTAR A MEDIDA CORTAR A MEDIDA SERPENTIN SERPENTIN C/ALT 105A C/AA, ALT. 145A A.A.  C/AA CORTAR A MEDIDA CORTAR A MEDIDA CORTAR A MEDIDA SERPENTIN SERPENTIN C/ALT 105A A.A.  SIN LLAVE (15 lbs) Sin palanca SERPENTIN A.A. 186°F  S/CALEFACTOR AUX., S/AA CORTAR A MEDIDA S/AA CORTAR A MEDIDA C/AA												
V-8, 6.0 L	2009	K040355SF A.A. STRECH FIT 91030 HERRAMIENTA INST. STRECH F 23127 MANGUERA INF. 23383 MANGUERA SUP. 36299 POLEA 38009 POLEA DEL TENSOR K060923 SERPENTIN K060930 SERPENTIN 31103 TAPON DE ACEITE 31843 TAPON DE GASOLINA 31844 TAPON DE GASOLINA 31532 TAPONES DE RADIADOR 39083 TENSOR 33963 TERMOSTATOS	SERPENTIN C/ALT. 105 A. C/ALT. 145 A.  CON LLAVE 15 LBS. SERPENTIN 186°	V-8, 5.3 L	2008	K040378 A.A. 23127 MANGUERA INF. 23383 MANGUERA SUP. 36299 POLEA 38009 POLEA DEL TENSOR 36169 POLEA DEL TENSOR K060930 SERPENTIN K060923 SERPENTIN 31103 TAPON DE ACEITE 31843 TAPON DE GASOLINA 31844 TAPON DE GASOLINA 31532 TAPONES DE RADIADOR 38159 TENSOR 38158 TENSOR 33963 TERMOSTATOS	SERPENTIN A.A. C/ALT. 145 A. C/ALT. 105 A.  CON LLAVE 15 LBS. A.A. SERPENTIN 186°	V-8, 6.0 L	2008	K040378 A.A. 23127 MANGUERA INF. 23383 MANGUERA SUP. 36299 POLEA 36169 POLEA DEL TENSOR 38009 POLEA DEL TENSOR K060930 SERPENTIN K060923 SERPENTIN 31103 TAPON DE ACEITE 31843 TAPON DE GASOLINA 31844 TAPON DE GASOLINA 31532 TAPONES DE RADIADOR 38158 TENSOR 38159 TENSOR 33963 TERMOSTATOS	A.A. C/ALT. 145 A. C/ALT. 105 A.  A.A. SERPENTIN C/ALT. 145 A. C/ALT. 105 A.  CON LLAVE 15 LBS. SERPENTIN A.A. SERPENTIN 186°	V-8, 5.3 L	2007	19729 MANG. CALEF. AUX. TUBO 2 A V 28466 MANG. CALEF. A VALVULA 18933 MANG. CALEF. AUX. TUBO1 22756 MANG. INF. 19761 MANG. MOTOR A CALEF. 19665 MANG. MOTOR A CALEF. AUX. 19750 MANG. MOTOR A VALVULA 18129 MANG. RAD. A VALV. REG. DE A 22755 MANG. SUP. 19279 MANG. VALV. A CALEF. 19749 MANG. VALVULA A CALEF. 19082 MANG. VALVULA A MOTOR 38001 POLEA 38009 POLEA K060923 SERPENTIN K060930 SERPENTIN K040378 SERPENTIN 31103 TAPON DE ACEITE 31852 TAPON DE GASOLINA 31532 TAPON DE RADIADOR 38158 TENSOR MICRO-V 38159 TENSOR MICRO-V 33963 TERMOSTATO	C/AA CORTAR A MEDIDA C/AA  S/CALEFACTOR AUX., S/AA S/AA, C/AA S/CALEFACTOR AUX., C/AA  A AUX.TUBO1, C/AA CORTAR A MEDIDA S/CALEFACTOR AUX., C/AA SERPENTIN SERPENTIN C/ALT 105 A C/ALT 145 A A.A.  SIN LLAVE REGULAR (15 lbs) Sin palanca	V-8, 6.0 L	2006	19729 MANG. CALEF. AUX. TUBO 2 A V 18933 MANG. CALEF. AUX. TUBO 1 A 19665 MANG. CALEF. A TUBO-2 22756 MANG. INF. 19761 MANG. MOTOR A CALEF. AUX. 19665 MANG. MOTOR A CALEF. AUX. 19750 MANG. MOTOR A VALVULA 18129 MANG. RAD. A VALV. REG. DE A 22755 MANG. SUP. 19665 MANG. VALV. A CALEF. AUX. T 19749 MANG. VALVULA A CALEF. 19082 MANG. VALVULA A MOTOR 38001 POLEA 38009 POLEA K060923 SERPENTIN K060930 SERPENTIN K040378 SERPENTIN 31103 TAPON DE ACEITE 31852 TAPON DE GASOLINA 31532 TAPON DE RADIADOR 38158 TENSOR MICRO-V 38159 TENSOR MICRO-V 33963 TERMOSTATO	C/AA C/AA S/AA & C/AA CORTAR A MEC C/AA CORTAR A MEDIDA  S/AA S/AA CORTAR A MEDIDA CORTAR A MEDIDA  C/AA CORTAR A MEDIDA CORTAR A MEDIDA SERPENTIN SERPENTIN C/ALT 105A C/AA, ALT. 145A A.A.  C/AA CORTAR A MEDIDA CORTAR A MEDIDA CORTAR A MEDIDA SERPENTIN SERPENTIN C/ALT 105A A.A.  SIN LLAVE (15 lbs) Sin palanca SERPENTIN A.A. 186°F  S/CALEFACTOR AUX., S/AA CORTAR A MEDIDA S/AA CORTAR A MEDIDA C/AA
V-8, 5.3 L	2007	19729 MANG. CALEF. AUX. TUBO 2 A V 28466 MANG. CALEF. A VALVULA 18933 MANG. CALEF. AUX. TUBO1 22756 MANG. INF. 19761 MANG. MOTOR A CALEF. 19665 MANG. MOTOR A CALEF. AUX. 19750 MANG. MOTOR A VALVULA 18129 MANG. RAD. A VALV. REG. DE A 22755 MANG. SUP. 19279 MANG. VALV. A CALEF. 19749 MANG. VALVULA A CALEF. 19082 MANG. VALVULA A MOTOR 38001 POLEA 38009 POLEA K060923 SERPENTIN K060930 SERPENTIN K040378 SERPENTIN 31103 TAPON DE ACEITE 31636 TAPON DE GASOLINA 31532 TAPON DE RADIADOR	C/AA CORTAR A MEDIDA C/AA  S/CALEFACTOR AUX., S/AA S/AA, C/AA S/CALEFACTOR AUX., C/AA  A AUX.TUBO1, C/AA CORTAR A MEDIDA S/CALEFACTOR AUX., C/AA SERPENTIN SERPENTIN C/ALT 105 A C/ALT 145 A A.A.  SIN LLAVE REGULAR (15 lbs) Sin palanca	V-8, 5.3 L	2005	19761 MANG. CALEF. A CALEF. 28466 MANG. CALEF. A VALVULA 19665 MANG. CALEF. AUX. TUBO 2 19729 MANG. CALEF. A TUBO-2 A VAL 19749 MANG. VALV. A CALEF. AUX. T 31852 TAPON DE GASOLINA 31532 TAPON DE RADIADOR 38158 TENSOR MICRO-V 38159 TENSOR MICRO-V 33963 TERMOSTATO	S/CALEFACTOR AUX., S/AA S/AA, C/AA S/CALEFACTOR AUX., C/AA  A AUX.TUBO1, C/AA CORTAR A MEDIDA S/CALEFACTOR AUX., C/AA SERPENTIN SERPENTIN C/ALT 105 A C/ALT 145 A A.A.  SIN LLAVE (15 lbs) Sin palanca	V-8, 6.0 L	2006	19729 MANG. CALEF. AUX. TUBO 2 A V 18933 MANG. CALEF. AUX. TUBO 1 A 19665 MANG. CALEF. A TUBO-2 22756 MANG. INF. 19761 MANG. MOTOR A CALEF. AUX. 19665 MANG. MOTOR A CALEF. AUX. 19750 MANG. MOTOR A VALVULA 18129 MANG. RAD. A VALV. REG. DE A 22755 MANG. SUP. 19665 MANG. VALV. A CALEF. AUX. T 19749 MANG. VALVULA A CALEF. 19082 MANG. VALVULA A MOTOR 38001 POLEA 38009 POLEA K060923 SERPENTIN K060930 SERPENTIN K040378 SERPENTIN 31103 TAPON DE ACEITE 31852 TAPON DE GASOLINA 31532 TAPON DE RADIADOR 38158 TENSOR MICRO-V 38159 TENSOR MICRO-V 33963 TERMOSTATO	C/AA C/AA S/AA & C/AA CORTAR A MEC C/AA CORTAR A MEDIDA  S/AA S/AA CORTAR A MEDIDA CORTAR A MEDIDA  C/AA CORTAR A MEDIDA CORTAR A MEDIDA SERPENTIN SERPENTIN C/ALT 105A C/AA, ALT. 145A A.A.  C/AA CORTAR A MEDIDA CORTAR A MEDIDA CORTAR A MEDIDA SERPENTIN SERPENTIN C/ALT 105A A.A.  SIN LLAVE (15 lbs) Sin palanca SERPENTIN A.A. 186°F  S/CALEFACTOR AUX., S/AA CORTAR A MEDIDA S/AA CORTAR A MEDIDA C/AA								

									
V-8, 5.3 L	2005	19665	MANG. MOTOR A CALEF. AUX.	CORTAR A MEDIDA		19665	MOTOR A CALEF. AUX. TUBO 2;	C/AA & S/AA; C/CALEFACTOR	
		19750	MANG. MOTOR A VALVULA	CORTAR A MEDIDA		19761	MOTOR A CALEF.;	S/AA; S/CALEFACTOR AUX.	
		18129	MANG. RAD. A VALV. REG. DE A			19750	MOTOR A VALV.;	C/AA; S/CALEF. AUX.	
		22755	MANG. SUP.			38009	POLEA	SERPENTIN	
		19279	MANG. VALV. A CALEF. AUX. TI	CORTAR A MEDIDA		38001	POLEA LOCA		
		19749	MANG. VALVULA A CALEF.	CORTAR A MEDIDA		35B 3/8"	RADIADOR A TANQ. DE RECUP.		
		18933	MANG. VALVULA A MOTOR	CORTAR A MEDIDA		18129	RADIADOR A VALV. REG. DE AII		
		38001	POLEA	SERPENTIN		K060923	SERPENTIN	C/ ALTERNADOR 105A.	
		38009	POLEA	SERPENTIN		K060930	SERPENTIN	C/ ALTERNADOR 145A.	
		K060923	SERPENTIN	C/ALT 105A		K040378	SERPENTIN	A.A.	
		K060930	SERPENTIN	C/ALT. 145A		31103	TAPON DE ACEITE		
		K040378	SERPENTIN	A.A.		31852	TAPON DE GASOLINA	SIN LLAVE	
		31103	TAPON DE ACEITE			31532	TAPON DE RADIADOR	(15 lbs) Sin palanca	
		31782	TAPON DE GASOLINA	CON LLAVE REGULAR		38159	SENSOR MICRO-V	A.A.	
		31532	TAPON DE RADIADOR	(15 lbs) Sin palanca		38158	SENSOR MICRO-V	SERPENTIN	
		V-8, 6.0 L	2005	38159	SENSOR MICRO-V	A.A.	33963	TERMOSTATO	186°F
19729	MANG. CALEF. AUX. TUBO 2 A V			C/AA		19082	VALV. A MOTOR; C/AA; S/ CALE		
18933	MANG. CALEF. AUX. TUBO 1 A			S/AA & C/AA	CORTAR A MEI	28408	VALV. DE AIRE A MOTOR		
19665	MANG. CALEF. A TUBO-2			C/AA	CORTAR A MEDIDA	19749	VALVULA A CALEF.		
22756	MANG. INF.					19279	VALVULA A CALEF. AUX. TUBO	; C/A.A.; C/CALEFACTOR AUX	
19761	MANG. MOTOR A CALEF. AUX.			S/AA	V-6, 4.3 L	2003	28467	CALEF. A TUBO-1	S/AA; S/Calefactor Auxiliar
19665	MANG. MOTOR A CALEF. AUX.			S/AA	CORTAR A MEDIDA		30T 3/4"	CALEF. A TUBO-2	S/AA; S/Calefactor Auxiliar
19750	MANG. MOTOR A VALVULA			CORTAR A MEDIDA		30T 3/4"	CALEF. A VALVULA	C/AA; S/Calefactor Auxiliar	
18129	MANG. RAD. A VALV. REG. DE A					28466	MANG. A TUBO-2 A MOTOR	CORTAR A MEDIDA	
22755	MANG. SUP.					28466	MANG. VALVULA A TUBO-2	CORTAR A MEDIDA	
19665	MANG. VALV. A CALEF. AUX. TI			C/AA	CORTAR A MEDIDA	19025	MANGUERA DE PASO		
19749	MANG. VALVULA A CALEF.			CORTAR A MEDIDA		22752	MANGUERA INF.		
19082	MANG. VALVULA A MOTOR			CORTAR A MEDIDA		22751	MANGUERA SUP.		
38009	POLEA			SERPENTIN		19700	MOTOR A CALEF. AUXILIAR		
38001	POLEA			SERPENTIN		38001	POLEA	LISO	
K060923	SERPENTIN			C/ALT 105A		38008	POLEA DEL TENSOR		
K060930	SERPENTIN	C/AA, ALT. 145A		35B 3/8"	RECUPERADOR				
K040378	SERPENTIN	A.A.		K060950	SERPENTIN	C/AA; C/105A, Alt.			
31103	TAPON DE ACEITE			K060960	SERPENTIN	C/AA; C/130A, Alt.			
31852	TAPON DE GASOLINA	SIN LLAVE		K060875	SERPENTIN	S/AA; C/124A., 140A. ALT			
31532	TAPON DE RADIADOR	(15 lbs) Sin palanca		K060870	SERPENTIN	S/AA; C/105A, Alt.			
38159	SENSOR MICRO-V	A.A.		31103	TAPON DE ACEITE				
38158	SENSOR MICRO-V	SERPENTIN		31636	TAPON DE GASOLINA	SIN LLAVE REGULAR			
33963	TERMOSTATO	186°F		31532	TAPON DE RADIADOR	(15 lbs) Sin palanca			
V-8, 5.3 L	2004	35B 5/8"	CALEF. A CALEF. AUX. TUBO 1;	S/AA; S/CALEFACTOR AUX.		38103	SENSOR MICRO-V		
		35B 5/8"	CALEF. A MOTOR			28466	TUBO-1 A MOTOR	S/AA; S/Calefactor Auxiliar	
		28466	CALEF. A VALVULA			28474	TUBO-1 A MOTOR	C/AA; S/Calefactor Auxiliar	
		18933	CALEF. AUX. TUBO 1 A MOTOR	; C/AA; C/CALEFACTOR AUX.		28475	TUBO-2 A MOTOR	S/AA; S/Calefactor Auxiliar; C/C	
		35B 3/4"	CALEF. AUX. TUBO 2 A CALEF.	; S/AA; C/CALEFACTOR AUX.		28474	TUBO-2 A MOTOR	S/AA; S/Calefactor Auxiliar; C/C	
		19729	CALEF. AUX. TUBO 2 A VALVUL	; C/AA; C/CALEFACTOR AUX.		28466	TUBO-2 A MOTOR	C/AA; S/Calefactor Auxiliar	
		22756	MANGUERA INF.			30T 5/8"	VALVULA A CALEF.	C/AA; S/Calefactor Auxiliar	
		22755	MANGUERA SUP.			28467	VALVULA A TUBO-2	C/AA; S/Calefactor Auxiliar	
		19665	MOTOR A CALEF. AUX. TUBO 2;	S/AA; C/CALEFACTOR AUX. V-8, 5.3 L	2003	K040378	A.A.		
		19665	MOTOR A CALEF. AUX. TUBO 2;	C/AA; C/Calefactor Auxiliar		22756	MANGUERA INF.		
		19761	MOTOR A CALEF.;	S/AA; S/CALEFACTOR AUX.		19665	MOTOR A TUBO-2 CALEF.	C/AA; C/Calefactor Auxiliar	
		19750	MOTOR A VALV.;	C/AA; S/CALEF. AUX.		19665	MOTOR A TUBO-2 CALEF.	S/AA; C/Calefactor Auxiliar	
		38009	POLEA	SERPENTIN		38009	POLEA	SERPENTIN	
		38001	POLEA LOCA	LISA		38001	POLEA	SERPENTIN	
		35B 3/8"	RADIADOR A TANQ. DE RECUP.			35B 3/8"	RECUPERADOR		
		18129	RADIADOR A VALV. REG. DE AII			K060923	SERPENTIN	C/105A, Alt.	
K060923	SERPENTIN	C/ ALTERNADOR 105A.		K060930	SERPENTIN	C/145A, ALT			
K060930	SERPENTIN	C/ ALTERNADOR 145A.		31103	TAPON DE ACEITE				
K040378	SERPENTIN	A.A.		31636	TAPON DE GASOLINA	SIN LLAVE REGULAR			
31103	TAPON DE ACEITE			31532	TAPON DE RADIADOR	(15 lbs) Sin palanca			
31636	TAPON DE GASOLINA	SIN LLAVE REGULAR		38159	SENSOR MICRO-V	A.C.			
31532	TAPON DE RADIADOR	(15 lbs) Sin palanca		38158	SENSOR MICRO-V	Serpentin			
38159	SENSOR MICRO-V	A.A.		19749	VALVULA A CALEF.				
38158	SENSOR MICRO-V	SERPENTIN	V-8, 6.0 L	2003	K040378	A.A.			
19082	VALV. A MOTOR; C/AA; S/ CALE			22756	MANGUERA INF.				
28408	VALV. DE AIRE A MOTOR			19665	MOTOR A TUBO-2 CALEF.	C/AA & S/AA; C/Calefactor Aux			
19749	VALVULA A CALEF.			38009	POLEA	SERPENTIN			
19279	VALVULA A CALEF. AUX. TUBO			38001	POLEA	SERPENTIN			
V-8, 6.0 L	2004	35B 5/8"	CALEF. A CALEF. AUX. TUBO 1;	S/AA; S/CALEF. AUX.		35B 3/8"	RECUPERADOR		
		35B 5/8"	CALEF. A MOTOR			K060923	SERPENTIN	C/105A, Alt.	
		28466	CALEF. A VALVULA			K060930	SERPENTIN	C/145A, ALT	
		18933	CALEF. AUX. TUBO 1 A MOTOR	; C/AA; C/CALEFACTOR AUX.		31103	TAPON DE ACEITE		
		35B 3/4"	CALEF. AUX. TUBO 2 A CALEF.	; S/AA; C/CALEFACTOR AUX.		31636	TAPON DE GASOLINA	SIN LLAVE REGULAR	
		19729	CALEF. AUX. TUBO 2 A VALVUL	; C/AA; C/CALEFACTOR AUX.		31532	TAPON DE RADIADOR	(15 lbs) Sin palanca	
		22756	MANGUERA INF.			38159	SENSOR MICRO-V	A.C.	
		22755	MANGUERA SUP.			38158	SENSOR MICRO-V	Serpentin	
						19749	VALVULA A CALEF.		
						K040378	A.A.		



    				    				
V-8, 6.0 L	2003	19749	VALVULA A CALEF.			K061015	SERPENTIN	C/Alt de 130A.
V-6, 4.3 L	2002	28467	CALEF. A TUBO-1	S/AA; S/Calefactor Auxiliar		K061005	SERPENTIN	C/Alt de 105A.
		30T 3/4"	CALEF. A TUBO-2	S/AA; S/Calefactor Auxiliar		38118	TENSOR MICRO-V	
		30T 3/4"	CALEF. A VALVULA	C/AA; S/Calefactor Auxiliar	V-8, 8.1 L	19666	CALEF. A VALVULA	S/Calef. Auxiliar
		92021	EDH	PRESION		22559	MANGUERA INF.	
		28466	MANG. A TUBO-2 A MOTOR	C/AA		22558	MANGUERA SUP.	
		28466	MANG. VALVULA A TUBO-2	C/AA		38008	POLEA	CON CANALES
		19025	MANGUERA DE PASO			38001	POLEA	LISO
		22426	MANGUERA INF.			38006	POLEA DEL TENSOR	
		22362	MANGUERA SUP.			38008	POLEA LOCA RANURADA	S/AA
		19700	MOTOR A CALEF. AUXILIAR			K060930	SERPENTIN	S/AA; C/Alt de 105A.
		38008	POLEA	CON CANALES		K061025	SERPENTIN	C/AA; C/Alt de 130A.
		38001	POLEA	LISO		K060935	SERPENTIN	S/AA; C/Alt de 130A.
		35B 3/8"	RECUPERADOR			K061015	SERPENTIN	C/AA; C/Alt de 105A.
		K060960	SERPENTIN	C/AA; C/130A. Alt.		31099	TAPON DE ACEITE	
		K060950	SERPENTIN	C/AA; C/105A. Alt.		31636	TAPON DE GASOLINA	SIN LLAVE REGULAR
		K060875	SERPENTIN	S/AA; C/124A., 140A. Alt.		31523	TAPON DE RADIADOR	(16 lbs) Sin Palanca
		K060870	SERPENTIN	S/AA; C/105A. Alt.		38258	TENSOR MICRO-V	
		31099	TAPON DE ACEITE			33329	TERMOSTATO	195°F
		31636	TAPON DE GASOLINA	SIN LLAVE REGULAR	V-6, 4.3 L	22426	MANGUERA INF.	
		31523	TAPON DE RADIADOR	(16 lbs) Sin Palanca		22362	MANGUERA SUP.	
		38103	TENSOR MICRO-V			19025	PASO	
		33019	TERMOSTATO	195°F		38008	POLEA	CON CANALES
		28466	TUBO-1 A MOTOR	S/AA; S/Calefactor Auxiliar		38001	POLEA	LISO
		28474	TUBO-1 A MOTOR	C/AA; S/Calefactor Auxiliar		K060950	SERPENTIN	C/AA; C/Alt de 105A.
		28475	TUBO-2 A MOTOR	S/AA; S/Calefactor Auxiliar; C/C		K060960	SERPENTIN	C/AA; C/Alt de 130A.
		28474	TUBO-2 A MOTOR	S/AA; S/Calefactor Auxiliar; C/C		K060870	SERPENTIN	S/AA; C/Alt de 105A.
		28466	TUBO-2 A MOTOR	C/AA; S/Calefactor Auxiliar		K060875	SERPENTIN	S/AA; C/Alt de 130A.
		30T 5/8"	VALVULA A CALEF.	C/AA; S/Calefactor Auxiliar		31099	TAPON DE ACEITE	
		28467	VALVULA A TUBO-2	C/AA; S/Calefactor Auxiliar		31636	TAPON DE GASOLINA	SIN LLAVE REGULAR
V-8, 5.0 L	2002	19225	CALEF. A TUBO-2	S/AA; S/Calef. Auxiliar		31523	TAPON DE RADIADOR	(16 lbs) Sin Palanca
		22425	MANGUERA INF.			38103	TENSOR MICRO-V	
		22357	MANGUERA SUP.			33019	TERMOSTATO	195°F
		19025	PASO		V-8, 5.0 L	19225	CALEF. A TUBO-2	S/AA; S/Calef. Auxiliar
		38001	POLEA	LISO		22425	MANGUERA INF.	
		38008	POLEA	CON CANALES		22357	MANGUERA SUP.	
		K060950	SERPENTIN	C/AA; C/Alt de 105A.		19025	PASO	
		K060960	SERPENTIN	C/AA; C/Alt de 130A.		38008	POLEA	CON CANALES
		K060875	SERPENTIN	S/AA; C/Alt de 124A., 140A.		38001	POLEA	LISO
		K060870	SERPENTIN	S/AA; C/Alt de 105A.		K060950	SERPENTIN	C/AA; C/Alt de 105A.
		31099	TAPON DE ACEITE			K060960	SERPENTIN	C/AA; C/Alt de 130A.
		31636	TAPON DE GASOLINA	SIN LLAVE REGULAR		K060870	SERPENTIN	S/AA; C/Alt de 105A.
		31523	TAPON DE RADIADOR	(16 lbs) Sin Palanca		K060875	SERPENTIN	S/AA; C/Alt de 130A.
		38103	TENSOR MICRO-V			31099	TAPON DE ACEITE	
		33019	TERMOSTATO	195°F		31636	TAPON DE GASOLINA	SIN LLAVE REGULAR
V-8, 5.7 L	2002	30T 3/4"	CALEF. A TUBO-1	S/AA; S/Calefactor Auxiliar		31523	TAPON DE RADIADOR	(16 lbs) Sin Palanca
		19225	CALEF. A TUBO-2	S/AA; S/Calefactor Auxiliar		38103	TENSOR MICRO-V	
		30T 3/4"	CALEF. A VALVULA	C/AA; S/Calefactor Auxiliar		33019	TERMOSTATO	195°F
		19025	MANGUERA DE PASO		V-8, 5.7 L	19225	CALEF. A TUBO-2	S/AA; S/Calef. Auxiliar
		22425	MANGUERA INF.			22425	MANGUERA INF.	
		22357	MANGUERA SUP.			22357	MANGUERA SUP.	
		19700	MOTOR A CALEF. AUXILIAR			19025	PASO	
		38001	POLEA	LISO		38008	POLEA	CON CANALES
		38008	POLEA	CON CANALES		38001	POLEA	LISO
		35B 3/8"	RECUPERADOR			K060950	SERPENTIN	C/AA; C/Alt de 105A.
		K060950	SERPENTIN	C/AA; C/105A. Alt.		K060960	SERPENTIN	C/AA; C/Alt de 130A.
		K060960	SERPENTIN	C/AA; C/130A. Alt.		K060870	SERPENTIN	S/AA; C/Alt de 105A.
		K060875	SERPENTIN	S/AA; C/124A., 140A. Alt.		K060875	SERPENTIN	S/AA; C/Alt de 130A.
		K060870	SERPENTIN	S/AA; C/105A. Alt.		31099	TAPON DE ACEITE	
		31099	TAPON DE ACEITE			31636	TAPON DE GASOLINA	SIN LLAVE REGULAR
		31636	TAPON DE GASOLINA	SIN LLAVE REGULAR		31523	TAPON DE RADIADOR	(16 lbs) Sin Palanca
		31523	TAPON DE RADIADOR	(16 lbs) Sin Palanca		38103	TENSOR MICRO-V	
		38103	TENSOR MICRO-V			33019	TERMOSTATO	195°F
		33019	TERMOSTATO	195°F		22359	MANGUERA INF.	
		28475	TUBO-1 A MOTOR	S/AA; S/Calefactor Auxiliar	V-8, 6.5 L	22360	MANGUERA SUP.	C/Alt de 105A., 130A.
		28466	TUBO-2 A MOTOR	S/AA; S/Calefactor Auxiliar		22210	PASO	
		28466	TUBO-2 A MOTOR	C/AA; S/Calefactor Auxiliar		38006	POLEA DEL TENSOR	
		30T 5/8"	VALVULA A CALEF.	C/AA; S/Calefactor Auxiliar		38020	POLEA LOCA	C/Doble Alt 105A.
		19773	VALVULA A MOTOR	C/AA; S/Calefactor Auxiliar		K061015	SERPENTIN	C/Alt de 130A.
		28468	VALVULA A TUBO-2	C/AA; S/Calefactor Auxiliar		K061005	SERPENTIN	C/Alt de 105A.
V-8, 6.5 L	2002	22359	MANGUERA INF.			38118	TENSOR MICRO-V	
		22360	MANGUERA SUP.	C/Alt de 105A., 130A.	V-8, 8.1 L	19666	CALEF. A VALVULA	S/Calef. Auxiliar
		22210	PASO			22559	MANGUERA INF.	
		38006	POLEA DEL TENSOR			22558	MANGUERA SUP.	
		38020	POLEA LOCA	C/Doble Alt 105A.		38001	POLEA	LISO



									
V-8, 8.1 L	2001	38008	POLEA	CON CANALES			K060960	SERPENTIN	C/AA; C/Alt de 124A., 140A.
		38006	POLEA DEL TENSOR				K060950	SERPENTIN	C/AA; C/Alt de 100A.
		38008	POLEA LOCA RANURADA	S/AA			K060870	SERPENTIN	S/AA; C/Alt de 100A.
		K060935	SERPENTIN	S/AA; C/Alt de 130A.			K060875	SERPENTIN	S/AA; C/Alt de 124A., 140A.
		K061015	SERPENTIN	C/AA; C/Alt de 105A.	V-8, 5.0 L		38103	TENSOR MICRO-V	S/AA
		K061025	SERPENTIN	C/AA; C/Alt de 130A.		1999	19225	CALEF. A TUBO-2	S/AA; S/Calef. Auxiliar
		K060930	SERPENTIN	S/AA; C/Alt de 105A.			21717	MANGUERA INF.	
		31099	TAPON DE ACEITE				22357	MANGUERA SUP.	
		31636	TAPON DE GASOLINA	SIN LLAVE REGULAR			19025	PASO	
		31523	TAPON DE RADIADOR	(16 lbs) Sin Palanca			38008	POLEA	CON CANALES
		38258	TENSOR MICRO-V				38001	POLEA	LISO
		33329	TERMOSTATO	195°F			K060960	SERPENTIN	C/AA; C/Alt de 124A., 140A.
V-6, 4.3 L	2000	22426	MANGUERA INF.				K060950	SERPENTIN	C/AA; C/Alt de 100A.
		22362	MANGUERA SUP.				K060870	SERPENTIN	S/AA; C/Alt de 100A.
		19025	PASO				K060875	SERPENTIN	S/AA; C/Alt de 124A., 140A.
		38001	POLEA	LISO			38103	TENSOR MICRO-V	
		38008	POLEA	CON CANALES	V-8, 5.7 L		19225	CALEF. A TUBO-2	S/AA; S/Calef. Auxiliar
		K060960	SERPENTIN	C/AA; C/Alt de 124A., 140A.			21717	MANGUERA INF.	
		K060950	SERPENTIN	C/AA; C/Alt de 100A.			22357	MANGUERA SUP.	
		K060870	SERPENTIN	S/AA; C/Alt de 100A.			19025	PASO	
		K060875	SERPENTIN	S/AA; C/Alt de 124A., 140A.			38001	POLEA	LISO
		38103	TENSOR MICRO-V	S/AA			38008	POLEA	CON CANALES
V-8, 5.0 L	2000	19225	CALEF. A TUBO-2	S/AA; S/Calef. Auxiliar			K060960	SERPENTIN	C/AA; C/Alt de 124A., 140A.
		353600(802)	EDH	PRESION			K060950	SERPENTIN	C/AA; C/Alt de 100A.
		22425	MANGUERA INF.				K060870	SERPENTIN	S/AA; C/Alt de 100A.
		22357	MANGUERA SUP.				K060875	SERPENTIN	S/AA; C/Alt de 124A., 140A.
		19025	PASO				31099	TAPON DE ACEITE	
		38008	POLEA	CON CANALES			31636	TAPON DE GASOLINA	SIN LLAVE REGULAR
		38001	POLEA	LISO			31532	TAPON DE RADIADOR	(15 lbs) Sin palanca
		K060960	SERPENTIN	C/AA; C/Alt de 124A., 140A.			38103	TENSOR MICRO-V	
		K060950	SERPENTIN	C/AA; C/Alt de 100A.			33019	TERMOSTATO	195°F
		K060875	SERPENTIN	S/AA; C/Alt de 124A., 140A.	V-8, 6.5 L		22359	MANGUERA INF.	
		K060870	SERPENTIN	S/AA; C/Alt de 100A.		1999	22360	MANGUERA SUP.	
		31099	TAPON DE ACEITE				22210	PASO	
		31636	TAPON DE GASOLINA	SIN LLAVE REGULAR			38006	POLEA DEL TENSOR	
		31523	TAPON DE RADIADOR	(16 lbs) Sin Palanca			38020	POLEA LOCA	C/Doble Alt.
		38103	TENSOR MICRO-V				K061015	SERPENTIN	C/Alt de 124A.
		33019	TERMOSTATO	195°F			38118	TENSOR MICRO-V	
V-8, 5.7 L	2000	19225	CALEF. A TUBO-2	S/AA; S/Calef. Auxiliar	V-8, 7.4 L		22365	MANGUERA INF.	
		22425	MANGUERA INF.				22360	MANGUERA SUP.	
		22357	MANGUERA SUP.				19670	PASO	
		19025	PASO				38008	POLEA	CON CANALES
		38001	POLEA	LISO			38001	POLEA	LISO
		38008	POLEA	CON CANALES			K060994	SERPENTIN	C/AA; S/Comp.; C/Alt de 124A.
		K060950	SERPENTIN	C/AA; C/Alt de 100A.			K060919	SERPENTIN	S/AA; S/Comp.; C/Alt de 124A.
		K060960	SERPENTIN	C/AA; C/Alt de 124A., 140A.			K061075	SERPENTIN	C/AA; C/Comp.; C/Alt de 124A.
		K060870	SERPENTIN	S/AA; C/Alt de 100A.			K060984	SERPENTIN	S/AA; C/Comp.; C/Alt de 124A.
		K060875	SERPENTIN	S/AA; C/Alt de 124A., 140A.			31099	TAPON DE ACEITE	
V-8, 6.5 L	2000	38103	TENSOR MICRO-V				31636	TAPON DE GASOLINA	SIN LLAVE REGULAR
		22359	MANGUERA INF.				31532	TAPON DE RADIADOR	(15 lbs) Sin palanca
		22360	MANGUERA SUP.				38103	TENSOR MICRO-V	
		22210	PASO				33329	TERMOSTATO	195°F
		38006	POLEA DEL TENSOR		V-6, 4.3 L		38008	POLEA	CON CANALES
		38020	POLEA LOCA	C/Doble Alt.		1998	38001	POLEA LOCA	
		K061015	SERPENTIN	C/Alt de 124A.			38103	TENSOR MICRO-V	
		31103	TAPON DE ACEITE		V-8, 5.0 L		38001	POLEA	S/AA
		31835	TAPON DE GASOLINA	SIN LLAVE REGULAR		1998	38008	POLEA	LISO
		31523	TAPON DE RADIADOR	(16 lbs) Sin Palanca			38103	TENSOR MICRO-V	CON CANALES
		38118	TENSOR MICRO-V		V-8, 5.7 L		38001	POLEA	LISO
		33922	TERMOSTATO	195°F		1998	38008	POLEA	CON CANALES
V-8, 7.4 L	2000	22365	MANGUERA INF.				38103	TENSOR MICRO-V	
		22360	MANGUERA SUP.		V-8, 7.4 L		38008	POLEA	CON CANALES
		19670	PASO				38001	POLEA	LISO
		38008	POLEA	CON CANALES	V-6, 4.3 L		38103	TENSOR MICRO-V	SERPENTIN
		38001	POLEA	LISO		1997	38001	POLEA	LISO
		K061075	SERPENTIN	C/AA; C/Comp.; C/Alt de 124A.			38008	POLEA	CON CANALES
		K060994	SERPENTIN	C/AA; S/Comp.; C/Alt de 124A.			38103	TENSOR MICRO-V	
		K060984	SERPENTIN	S/AA; C/Comp.; C/Alt de 124A.V-8, 5.0 L			38001	POLEA	LISO
		K060919	SERPENTIN	S/AA; S/Comp.; C/Alt de 124A.		1997	38008	POLEA	CON CANALES
V-8, 4.3 L	1999	38103	TENSOR MICRO-V		V-8, 5.7 L		38103	TENSOR MICRO-V	
		22374	MANGUERA INF.			1997	38001	POLEA	LISO
		22362	MANGUERA SUP.				38008	POLEA	CON CANALES
		19025	PASO				38103	TENSOR MICRO-V	
		38001	POLEA	LISO	V-8, 7.4 L		38008	POLEA	CON CANALES
		38008	POLEA	CON CANALES		1997	38001	POLEA	LISO



V-8, 7.4 L | 1997 | 38103 | TENSOR MICRO-V | SERPENTIN



31103 | TAPON DE ACEITE | (15 lbs) Sin palanca  
31532 | TAPON DE RADIADOR | MICRO  
38103 | TENSOR MICRO-V | 195°F  
33019 | TERMOSTATO |  
19025 | MANG. DE PASO |  
23128 | MANG. INF. |  
22751 | MANG. SUP. |  
38001 | POLEA LOCA | LISA  
38008 | POLEA LOCA | RANURADA S/AA  
K060960 | SERPENTIN | C/AA, ALT. 145A  
K060950 | SERPENTIN | C/AA, C/ALT 105A  
K060876 | SERPENTIN |  
K060875 | SERPENTIN | S/AA, C/ALT. 145A  
K060868 | SERPENTIN | S/AA, C/ALT. 105A  
31103 | TAPON DE ACEITE |  
31532 | TAPON DE RADIADOR | (15 lbs) Sin palanca  
38103 | TENSOR MICRO-V | MICRO  
33019 | TERMOSTATO | 195°F  
2004 | 35B 5/8" | MANGUERA DE CALEF.  
35B 3/8" | MANGUERA DE CALEF.  
35B 3/4" | MANGUERA DE CALEF.  
19025 | Manguera de paso | MANGUERA DE PASO  
22751 | MANGUERA SUP. |  
38001 | POLEA | LOCA  
38008 | POLEA | LOCA  
K060950 | SERPENTIN |  
K060960 | SERPENTIN |  
K060868 | SERPENTIN |  
K060875 | SERPENTIN |  
31103 | TAPON DE ACEITE |  
31532 | TAPON DE RADIADOR | (15 lbs) Sin palanca  
33019 | TERMOSTATO | 195°F  
2000 | 353600(802) | EDH | PRESION  
19025 | MANGUERA DE PASO |  
21717 | MANGUERA INF. |  
22357 | MANGUERA SUP. |  
K060950 | SERPENTIN | C/AA, 100 AMP  
K060960 | SERPENTIN | C/AA, 140 AMP  
K060870 | SERPENTIN | S/AA, 100 AMP  
K060875 | SERPENTIN | S/AA, 140 AMP  
31099 | TAPON DE ACEITE |  
31636 | TAPON DE GASOLINA | SIN LLAVE REGULAR  
31532 | TAPON DE RADIADOR | (15 lbs) Sin palanca  
33019 | TERMOSTATO | 195°F  
1999 | 19025 | MANGUERA DE PASO |  
21717 | MANGUERA INF. |  
22357 | MANGUERA SUP. |  
K060950 | SERPENTIN | C/AA, 100 AMP  
K060960 | SERPENTIN | C/AA, 140 AMP  
K060870 | SERPENTIN | S/AA, 100 AMP  
K060875 | SERPENTIN | S/AA, 140 AMP  
1998 | 353600(802) | EDH | PRESION  
K060950 | SERPENTIN | C/AA, 100 AMP  
K060960 | SERPENTIN | C/AA, 140 AMP  
K060870 | SERPENTIN | S/AA, 100 AMP  
K060875 | SERPENTIN | S/AA, 140 AMP  
31099 | TAPON DE ACEITE |  
31636 | TAPON DE GASOLINA | SIN LLAVE REGULAR  
31532 | TAPON DE RADIADOR | (15 lbs) Sin palanca  
33019 | TERMOSTATO | 195°F

## EXPRESS CARGO VAN

V-6, 4.3 L	2010	19025	MANGUERA DE PASO		V-6, 4.3 L	2005	19025	MANG. DE PASO	
		23128	MANGUERA INF.				23128	MANG. INF.	
		22751	MANGUERA SUP.				22751	MANG. SUP.	
		38008	POLEA				38001	POLEA LOCA	LISA
		38008	POLEA				38008	POLEA LOCA	RANURADA S/AA
		36299	POLEA DEL TENSOR				K060960	SERPENTIN	C/AA, ALT. 145A
		K060960	SERPENTIN	C/A.A. ALT. 145 A.			K060950	SERPENTIN	C/AA, C/ALT 105A
		K060960	SERPENTIN	C/A.A. ALT. 125 A.			K060876	SERPENTIN	
		K060875	SERPENTIN	S/A.A. ALT. 125 A.			K060875	SERPENTIN	S/AA, C/ALT. 145A
		K060878	SERPENTIN	S/A.A. ALT. 145 A.			K060868	SERPENTIN	S/AA, C/ALT. 105A
		31103	TAPON DE ACEITE				31103	TAPON DE ACEITE	
		31843	TAPON DE GASOLINA				31532	TAPON DE RADIADOR	(15 lbs) Sin palanca
		31844	TAPON DE GASOLINA	CON LLAVE			38103	TENSOR MICRO-V	MICRO
		31532	TAPONES DE RADIADOR	15 LBS.			33019	TERMOSTATO	195°F
		38103	TENSOR				2004	35B 5/8"	MANGUERA DE CALEF.
		33019	TERMOSTATOS	195°	V-6, 4.3 L	2004	35B 3/8"	MANGUERA DE CALEF.	
V-6, 4.3 L	2009	19025	MANGUERA DE PASO				35B 3/4"	MANGUERA DE CALEF.	
		23128	MANGUERA INF.				19025	Manguera de paso	MANGUERA DE PASO
		22751	MANGUERA SUP.				22751	MANGUERA SUP.	
		38008	POLEA				38001	POLEA	LOCA
		38008	POLEA				38008	POLEA	LOCA
		36299	POLEA DEL TENSOR				K060950	SERPENTIN	
		K060875	SERPENTIN	S/A.A. ALT. 125 A.			K060960	SERPENTIN	
		K060960	SERPENTIN	C/A.A. ALT. 125 A.			K060868	SERPENTIN	
		K060878	SERPENTIN	S/A.A. ALT. 145 A.			K060875	SERPENTIN	
		K060960	SERPENTIN	C/A.A. ALT. 145 A.			31103	TAPON DE ACEITE	
		31103	TAPON DE ACEITE				31532	TAPON DE RADIADOR	(15 lbs) Sin palanca
		31844	TAPON DE GASOLINA	CON LLAVE			33019	TERMOSTATO	195°F
		31843	TAPON DE GASOLINA				2000	353600(802)	EDH
		31532	TAPONES DE RADIADOR	15 LBS.	V-8, 5.7 L	2000	19025	MANGUERA DE PASO	
		38103	TENSOR				21717	MANGUERA INF.	
		33019	TERMOSTATOS	195°			22357	MANGUERA SUP.	
V-6, 4.3 L	2008	19025	MANGUERA DE PASO				K060950	SERPENTIN	C/AA, 100 AMP
		23128	MANGUERA INF.				K060960	SERPENTIN	C/AA, 140 AMP
		22751	MANGUERA SUP.				K060870	SERPENTIN	S/AA, 100 AMP
		38008	POLEA				K060875	SERPENTIN	S/AA, 140 AMP
		38008	POLEA				31099	TAPON DE ACEITE	
		36299	POLEA DEL TENSOR				31636	TAPON DE GASOLINA	SIN LLAVE REGULAR
		K060950	SERPENTIN	C/A.A. ALT. 105 A.			31532	TAPON DE RADIADOR	(15 lbs) Sin palanca
		K060960	SERPENTIN	C/A.A. ALT. 145 A.			33019	TERMOSTATO	195°F
		K060868	SERPENTIN	S/A.A. ALT. 105 A.	V-8, 5.7 L	1999	19025	MANGUERA DE PASO	
		K060875	SERPENTIN	S/A.A. ALT. 145 A.			21717	MANGUERA INF.	
		31103	TAPON DE ACEITE				22357	MANGUERA SUP.	
		31843	TAPON DE GASOLINA				K060950	SERPENTIN	C/AA, 100 AMP
		31844	TAPON DE GASOLINA	CON LLAVE			K060960	SERPENTIN	C/AA, 140 AMP
		31532	TAPONES DE RADIADOR	15 LBS.	V-8, 5.7 L	1999	K060870	SERPENTIN	S/AA, 100 AMP
		38103	TENSOR				K060875	SERPENTIN	S/AA, 140 AMP
		33019	TERMOSTATOS	195°	V-8, 5.7 L	1998	353600(802)	EDH	PRESION
V-6, 4.3 L	2007	19025	MANG. DE PASO				K060950	SERPENTIN	C/AA, 100 AMP
		23128	MANG. INF.				K060960	SERPENTIN	C/AA, 140 AMP
		22751	MANG. SUP.				K060870	SERPENTIN	S/AA, 100 AMP
		38001	POLEA LOCA	LISA			K060875	SERPENTIN	S/AA, 140 AMP
		38008	POLEA LOCA	RANURADA S/AA			31099	TAPON DE ACEITE	
		K060960	SERPENTIN	C/AA, ALT 145 A			31636	TAPON DE GASOLINA	SIN LLAVE REGULAR
		K060950	SERPENTIN	C/AA, C/ALT 105A			31532	TAPON DE RADIADOR	(15 lbs) Sin palanca
		K060875	SERPENTIN	S/AA, C/ALT. 145 A			33019	TERMOSTATO	195°F
		K060868	SERPENTIN	S/AA, C/ALT. 105 A					
		31103	TAPON DE ACEITE						
		31532	TAPON DE RADIADOR	(15 lbs) Sin palanca					
		38103	TENSOR MICRO-V	MICRO	V-6, 4.3 L	2000	K060960	SERPENTIN	C/AA 140 AMP
		33019	TERMOSTATO	195°F			K060950	SERPENTIN	C/AA 100 AMP
V-6, 4.3 L	2006	19025	MANG. DE PASO				K060870	SERPENTIN	S/AA 100 AMP
		23128	MANG. INF.				K060875	SERPENTIN	S/AA 140 AMP
		22751	MANG. SUP.				31099	TAPON DE ACEITE	
		38008	POLEA LOCA	RANURADA S/AA			31636	TAPON DE GASOLINA	SIN LLAVE REGULAR
		38001	POLEA LOCA	LISA			31523	TAPON DE RADIADOR	(16 lbs) Sin Palanca
		K060960	SERPENTIN	C/AA, ALT. 145A			33019	TERMOSTATO	195°F
		K060950	SERPENTIN	C/AA, C/ALT 105A	V-6, 4.3 L	1999	92021	EDH	PRESION
		K060875	SERPENTIN	S/AA, C/ALT. 145A			K060950	SERPENTIN	C/AA 100 AMP
		K060868	SERPENTIN	S/AA, C/ALT. 105A			K060960	SERPENTIN	C/AA 140 AMP
		K060876	SERPENTIN				K060875	SERPENTIN	S/AA 140 AMP

## EXPRESS VAN

V-6, 4.3 L	2000	K060960	SERPENTIN	C/AA 140 AMP
		K060950	SERPENTIN	C/AA 100 AMP
		K060870	SERPENTIN	S/AA 100 AMP
		K060875	SERPENTIN	S/AA 140 AMP
		31099	TAPON DE ACEITE	
		31636	TAPON DE GASOLINA	SIN LLAVE REGULAR
		31523	TAPON DE RADIADOR	(16 lbs) Sin Palanca
		33019	TERMOSTATO	195°F
		92021	EDH	PRESION
		K060950	SERPENTIN	C/AA 100 AMP
		K060960	SERPENTIN	C/AA 140 AMP
		K060875	SERPENTIN	S/AA 140 AMP

V-6, 4.3 L	1999	K060870	SERPENTIN	S/AA 100 AMP
		31099	TAPON DE ACEITE	
		31636	TAPON DE GASOLINA	SIN LLAVE REGULAR
		31523	TAPON DE RADIADOR	(16 lbs) Sin Palanca
		33019	TERMOSTATO	195°F
V-6, 4.3 L	1998	K060960	SERPENTIN	C/AA 140 AMP
		K060950	SERPENTIN	C/AA 100 AMP
		K060875	SERPENTIN	S/AA 140 AMP
		K060870	SERPENTIN	S/AA 100 AMP
		31099	TAPON DE ACEITE	
		31636	TAPON DE GASOLINA	SIN LLAVE REGULAR
		31523	TAPON DE RADIADOR	(16 lbs) Sin Palanca
		33019	TERMOSTATO	195°F

V-8, 5.7 L	1998	31523	TAPON DE RADIADOR	(16 lbs) Sin Palanca
		33019	TERMOSTATO	195°F
		19025	MANGUERA DE PASO	
		21717	MANGUERA INF.	
		22357	MANGUERA SUP.	
		K060950	SERPENTIN	C/AA, 100 AMP
		K060960	SERPENTIN	C/AA, 140 AMP
		K060875	SERPENTIN	S/AA, 140 AMP
		K060870	SERPENTIN	S/AA, 100 AMP

### EXPRESS VAN LUJO

V-8, 5.7 L	2000	K060960	SERPENTIN	C/AA, 140 AMP
		K060950	SERPENTIN	C/AA, 100 AMP
		K060870	SERPENTIN	S/AA, 100 AMP
		K060875	SERPENTIN	S/AA, 140 AMP
		K060950	SERPENTIN	C/AA, 100 AMP
V-8, 5.7 L	1999	K060960	SERPENTIN	C/AA, 100 AMP
		K060960	SERPENTIN	C/AA, 140 AMP
		K060870	SERPENTIN	S/AA, 100 AMP
		K060875	SERPENTIN	S/AA, 140 AMP
		K060960	SERPENTIN	C/AA, 140 AMP
V-8, 5.7 L	1998	K060960	SERPENTIN	C/AA, 140 AMP
		K060950	SERPENTIN	C/AA, 100 AMP
		K060870	SERPENTIN	S/AA, 100 AMP
		K060875	SERPENTIN	S/AA, 140 AMP
		K060875	SERPENTIN	S/AA, 140 AMP

### EXPRESS VAN PASAJEROS











V-8, 5.7 L	2000	19025	MANGUERA DE PASO	S/AA, C/DH
		22426	MANGUERA INF.	S/AA, C/DH
		22362	MANGUERA SUP.	S/AA, C/DH
		K060950	SERPENTIN	C/AA 100 AMP
		K060960	SERPENTIN	C/AA 140 AMP
		K060875	SERPENTIN	S/AA 140 AMP
		K060870	SERPENTIN	S/AA 100 AMP
		31099	TAPON DE ACEITE	
		31636	TAPON DE GASOLINA	SIN LLAVE REGULAR
		31523	TAPON DE RADIADOR	(16 lbs) Sin Palanca
V-8, 5.7 L	2000	33019	TERMOSTATO	195°F
		19025	MANGUERA DE PASO	
		21717	MANGUERA INF.	
		22357	MANGUERA SUP.	
		K060960	SERPENTIN	C/AA, 140 AMP
		K060950	SERPENTIN	C/AA, 100 AMP
		K060870	SERPENTIN	S/AA, 100 AMP
		K060875	SERPENTIN	S/AA, 140 AMP
		19025	MANGUERA DE PASO	S/AA, C/DH
		22374	MANGUERA INF.	S/AA, C/DH
V-6, 4.3 L	1999	22362	MANGUERA SUP.	S/AA, C/DH
		K060950	SERPENTIN	C/AA 100 AMP
		K060960	SERPENTIN	C/AA 140 AMP
		K060875	SERPENTIN	S/AA 140 AMP
		K060870	SERPENTIN	S/AA 100 AMP
		31099	TAPON DE ACEITE	
		31636	TAPON DE GASOLINA	SIN LLAVE REGULAR
		31523	TAPON DE RADIADOR	(16 lbs) Sin Palanca
		33019	TERMOSTATO	195°F
		19025	MANGUERA DE PASO	
V-8, 5.7 L	1999	21717	MANGUERA INF.	
		22357	MANGUERA SUP.	
		K060950	SERPENTIN	C/AA, 100 AMP
		K060960	SERPENTIN	C/AA, 140 AMP
		K060870	SERPENTIN	S/AA, 100 AMP
		K060875	SERPENTIN	S/AA, 140 AMP
		19025	MANGUERA DE PASO	S/AA, C/DH
		21717	MANGUERA INF.	S/AA, C/DH
		22357	MANGUERA SUP.	S/AA, C/DH
		19025	MANGUERA DE PASO	S/AA, C/DH
V-6, 4.3 L	1998	22374	MANGUERA INF.	S/AA, C/DH
		22362	MANGUERA SUP.	S/AA, C/DH
		K060950	SERPENTIN	C/AA 100 AMP
		K060960	SERPENTIN	C/AA 140 AMP
		K060870	SERPENTIN	S/AA 100 AMP
		K060875	SERPENTIN	S/AA 140 AMP
		31099	TAPON DE ACEITE	
		31636	TAPON DE GASOLINA	SIN LLAVE REGULAR

### HHR

4 CIL, 2.4 L	2010	19478	MANGUERA CALEFACCION	TERMOSTATO A CALEF.
		19848	MANGUERA CALEFACCION	AL TERMOSTATO
		23384	MANGUERA INF.	
		23163	MANGUERA SUP.	
		36193	POLEA DEL TENSOR	
		K050405	SERPENTIN	
		31532	TAPONES DE RADIADOR	15 LBS.
		38177	TENSOR	
		33943	TERMOSTATOS	180°
		19478	MANGUERA CALEFACCION	TERMOSTATO A CALEF.
4 CIL, 2.4 L	2009	19848	MANGUERA CALEFACCION	AL TERMOSTATO
		23384	MANGUERA INF.	
		23163	MANGUERA SUP.	
		36193	POLEA DEL TENSOR	
		K050405	SERPENTIN	
		31532	TAPONES DE RADIADOR	15 LBS.
		38177	TENSOR	
		33943	TERMOSTATOS	180°
		19848	MANGUERA CALEFACCION	AL TERMOSTATO
		19478	MANGUERA CALEFACCION	TERMOSTATO A CALEF.
4 CIL, 2.4 L	2008	19478	MANGUERA CALEFACCION	TERMOSTATO A CALEF.
		23164	MANGUERA INF.	
		23163	MANGUERA SUP.	
		K050405	SERPENTIN	
		31103	TAPON DE ACEITE	
		31843	TAPON DE GASOLINA	
		31532	TAPON DE RADIADOR	15 LIBRAS
		38177	TENSOR MICRO-V	
		33943	TERMOSTATO	180 ° F
		19848	MANGUERA CALEFACCION	AL TERMOSTATO
4 CIL, 2.4 L	2007	19478	MANGUERA CALEFACCION	TERMOSTATO A CALEF.
		23164	MANGUERA INF.	
		23163	MANGUERA SUP.	
		38011	POLEA	
		K050400	SERPENTIN	
		31103	TAPON DE ACEITE	
		31843	TAPON DE GASOLINA	
		31532	TAPON DE RADIADOR	15 LIBRAS
		38177	TENSOR MICRO-V	
		33943	TERMOSTATO	180 ° F
4 CIL, 2.4 L	2006	19478	MANGUERA CALEFACCION	TERMOSTATO A CALEF.
		19848	MANGUERA CALEFACCION	AL TERMOSTATO
		23164	MANGUERA INF.	
		23163	MANGUERA SUP.	
		38011	POLEA	
		K050400	SERPENTIN	
		31103	TAPON DE ACEITE	
		31843	TAPON DE GASOLINA	
		31532	TAPON DE RADIADOR	15 LIBRAS
		38177	TENSOR MICRO-V	

### IMPALA

V-6, 3.4 L	2005	35B 3/8"	MANGUERA DE CALEFACCION	TANQUE DE RECUPERACION
		19026	MANGUERA DE CALEFACCION	MANGUERA DE PASO
		22813	MANGUERA INF.	
		22814	MANGUERA SUP.	
		38001	POLEA	
		K060703	SERPENTIN	
		31103	TAPON DE ACEITE	
		31636	TAPON DE GASOLINA	SIN LLAVE REGULAR
		31782	TAPON DE GASOLINA	CON LLAVE REGULAR
		31532	TAPON DE RADIADOR	(15 lbs) Sin palanca
		38105	TENSOR MICRO-V	

    				    				
V-6, 3.4 L	2005	33329	TERMOSTATO	195°F		31636	TAPON DE GASOLINA	SIN LLAVE REGULAR
V-6, 3.8 L	2005	92041	EDH	PRESION		31782	TAPON DE GASOLINA	CON LLAVE REGULAR
		35B 3/8"	MANGUERA DE CALEFACCIÓN	TANQUE DE RECUPERACIÓN		31516	TAPON DE RADIADOR	(16 lbs) Con palanca
		22373	MANGUERA INF.			31523	TAPON DE RADIADOR	(16 lbs) Sin Palanca
		22814	MANGUERA SUP.			38271	TENSOR MICRO-V	
		38006	POLEA			33429	TERMOSTATO	195°F
		38007	POLEA	LOCA	V-6, 3.4 L	2002	19211	CALEF. A TUBO-2
		38009	POLEA	LOCA			92054	EDH
		38001	POLEA	SUPER CARGADO (LISO)			22345	MANGUERA INF.
		K060663	SERPENTIN				22344	MANGUERA SUP.
		K060905	SERPENTIN				19026	PASO
		31103	TAPON DE ACEITE				38001	POLEA DEL TENSOR
		31636	TAPON DE GASOLINA	SIN LLAVE REGULAR			K060703	SERPENTIN
		31782	TAPON DE GASOLINA	CON LLAVE REGULAR			31103	TAPON DE ACEITE
		31532	TAPON DE RADIADOR	(15 lbs) Sin palanca			31636	TAPON DE GASOLINA
		38271	TENSOR MICRO-V				31782	TAPON DE GASOLINA
		33329	TERMOSTATO	195°F			31523	TAPON DE RADIADOR
V-6, 3.4 L	2004	19210	CALEF. A TUBO-1				31516	TAPON DE RADIADOR
		19211	CALEF. A TUBO-2				38105	TENSOR MICRO-V
		92054	EDH	PRESION			33329	TERMOSTATO
		19026	MANGUER DE PASO		V-6, 3.8 L	2002	19121	CALEF. A MOTOR
		22813	MANGUERA INF.				19120	CALEF. A MOTOR
		22814	MANGUERA SUP.				92041	EDH
		38001	POLEA				22373	MANGUERA INF.
		K060703	SERPENTIN				22344	MANGUERA SUP.
		35B 3/8"	TANQUE DE RECUP. A RADIAD				38006	POLEA DEL TENSOR
		31103	TAPON DE ACEITE				K060915	SERPENTIN
		31636	TAPON DE GASOLINA	SIN LLAVE REGULAR			35B 3/8"	TANQUE DE RECUP. A RADIAD
		31782	TAPON DE GASOLINA	CON LLAVE REGULAR			31103	TAPON DE ACEITE
		31523	TAPON DE RADIADOR	(16 lbs) Sin Palanca			31636	TAPON DE GASOLINA
		38105	TENSOR MICRO-V				31782	TAPON DE GASOLINA
		33329	TERMOSTATO	195°F			31523	TAPON DE RADIADOR
		18020	TUBO-1 A VALV. REG. DE AIRE				31516	TAPON DE RADIADOR
		28408	VALV. REG. DE AIRE A TUBO 1				38271	TENSOR MICRO-V
V-6, 3.8 L	2004	19321	CALEF. A MOTOR, INF.				33429	TERMOSTATO
		19320	CALEF. A MOTOR, SUP.		V-6, 3.4 L	2001	19211	CALEF. A TUBO-2
		92041	EDH	PRESION			92054	EDH
		22373	MANGUERA INF.				22345	MANGUERA INF.
		22814	MANGUERA SUP.				22344	MANGUERA SUP.
		38006	POLEA				19026	PASO
		38009	POLEA LOCA	Ranurada, C/Super Cargador			38001	POLEA DEL TENSOR
		38007	POLEA LOCA	Lisa, C/Super Cargador			K060703	SERPENTIN
		K060663	SERPENTIN	A.A.			31103	TAPON DE ACEITE
		K060905	SERPENTIN				31636	TAPON DE GASOLINA
		35B 3/8"	TANQUE DE RECUP. A RADIAD				31782	TAPON DE GASOLINA
		31103	TAPON DE ACEITE				31516	TAPON DE RADIADOR
		31636	TAPON DE GASOLINA	SIN LLAVE REGULAR			31523	TAPON DE RADIADOR
		31782	TAPON DE GASOLINA	CON LLAVE REGULAR			38105	TENSOR MICRO-V
		31523	TAPON DE RADIADOR	(16 lbs) Sin Palanca			33329	TERMOSTATO
		31532	TAPON DE RADIADOR	(15 lbs) Sin palanca	V-6, 3.8 L	2001	19121	CALEF. A MOTOR
		38271	TENSOR MICRO-V	ACCESORIO			19120	CALEF. A MOTOR
V-6, 3.8 L	2004	33429	TERMOSTATO	195°F			92041	EDH
		92054	EDH	PRESION			22373	MANGUERA INF.
V-6, 3.4 L	2003	19210	MANG. CALEF. A TUBO-1				22344	MANGUERA SUP.
		19211	MANG. CALEF. A TUBO-2				38006	POLEA DEL TENSOR
		19026	MANG. DE PASO				K060915	SERPENTIN
		18020	MANG. TUBO-1 A VALV. DE AIRE	CORTAR A MEDIDA			31103	TAPON DE ACEITE
		38001	POLEA				31636	TAPON DE GASOLINA
		K060703	SERPENTIN				31782	TAPON DE GASOLINA
		31103	TAPON DE ACEITE				31516	TAPON DE RADIADOR
		31636	TAPON DE GASOLINA	SIN LLAVE REGULAR			31523	TAPON DE RADIADOR
		31782	TAPON DE GASOLINA	CON LLAVE REGULAR			38271	TENSOR MICRO-V
		31516	TAPON DE RADIADOR	(16 lbs) Con palanca			33429	TERMOSTATO
		31523	TAPON DE RADIADOR	(16 lbs) Sin Palanca	V-6, 3.4 L	2000	19211	CALEF. A TUBO-2
		38105	TENSOR MICRO-V				92054	EDH
		33329	TERMOSTATO	195°F			22345	MANGUERA INF.
V-6, 3.8 L	2003	19121	CALEF. A MOTOR	Inferior			22344	MANGUERA SUP.
		19120	CALEF. A MOTOR	Superior			19026	PASO
		92041	EDH	PRESION			38001	POLEA DEL TENSOR
		22373	MANGUERA INF.				K060703	SERPENTIN
		22344	MANGUERA SUP.				31103	TAPON DE ACEITE
		38006	POLEA				31636	TAPON DE GASOLINA
		K060919	SERPENTIN				31782	TAPON DE GASOLINA
		35B 3/8"	TANQUE DE RECUP. A RADIAD				31523	TAPON DE RADIADOR
		31103	TAPON DE ACEITE				31516	TAPON DE RADIADOR

V-6, 3.4 L	2000	38105 33329	TENSOR MICRO-V TERMOSTATO	195°F
V-6, 3.8 L	2000	19120 19121 92041 22373 22344 38006 K060915 31103 31636 31782 31516 31523 38271 33429	CALEF. A MOTOR CALEF. A MOTOR EDH MANGUERA INF. MANGUERA SUP. POLEA DEL TENSOR SERPENTIN TAPON DE ACEITE TAPON DE GASOLINA TAPON DE GASOLINA TAPON DE RADIADOR TAPON DE RADIADOR TENSOR MICRO-V TERMOSTATO	Superior Inferior PRESION       SIN LLAVE REGULAR CON LLAVE REGULAR (16 lbs) Con palanca (16 lbs) Sin Palanca  195°F

		9380 9378 CH-140242 CH-140231 7417 T1502 9380 9378 CH-140242 CH-140231 6417 GS 8380GS 8371 GS	COMPRESOR DE AIRE D.H. MANG. INF. MANG. SUP. ALT. y VENTILADOR BANDA ARBOL DE LEVAS COMPRESOR DE AIRE D.H. MANG. INF. MANG. SUP. ALT. BANDA A.A., D.H.	4 CIL, 2.2 L          4 CIL, 2.2 L          4 CIL, 2.4 L

**LUMINA**

V-6, 3.1 L	1998	91962 19026 21991 22052 38001 K060695 31103 31636 31523 31516 33329	EDH MANGUERA DE PASO MANGUERA INF. MANGUERA SUP. POLEA SERPENTIN TAPON DE ACEITE TAPON DE GASOLINA TAPON DE RADIADOR TAPON DE RADIADOR TERMOSTATO	PRESION       SIN LLAVE REGULAR (16 lbs) Sin Palanca (16 lbs) Con palanca 195°F
V-6, 3.4 L	1998	T192 91808 TCK192 K060730 31103 31279 31748 31516 31523 33329	BANDA ARBOL DE LEVAS EDH KIT DE DISTRIBUCION SERPENTIN TAPON DE ACEITE TAPON DE ACEITE TAPON DE GASOLINA TAPON DE RADIADOR TAPON DE RADIADOR TERMOSTATO	PRESION       SIN LLAVE REGULAR (16 lbs) Con palanca (16 lbs) Sin Palanca 195°F
V-6, 3.8 L	1998	92022 38015 38006 31103 31523 31516 38152	EDH POLEA POLEA TAPON DE ACEITE TAPON DE RADIADOR TAPON DE RADIADOR TENSOR MICRO-V	PRESION       (16 lbs) Sin Palanca (16 lbs) Con palanca
V-6, 3.1 L	1997	38007 31103 31523 31516 38105	POLEA TAPON DE ACEITE TAPON DE RADIADOR TAPON DE RADIADOR TENSOR MICRO-V	(16 lbs) Sin Palanca (16 lbs) Con palanca
V-6, 3.4 L	1997	T192 91808 TCK273 TCK192 38027 K060730 31103 31279 31748 31516 31523 38198 33329	BANDA ARBOL DE LEVAS EDH KIT DE DISTRIBUCION KIT DE DISTRIBUCION POLEA SERPENTIN TAPON DE ACEITE TAPON DE ACEITE TAPON DE GASOLINA TAPON DE RADIADOR TAPON DE RADIADOR TENSOR MICRO-V TERMOSTATO	PRESION       SIN LLAVE REGULAR (16 lbs) Con palanca (16 lbs) Sin Palanca  195°F

**MALIBU**











	2010	19447 19447 23431 23491 23472 23021 36193 K050402 31532 38177 33943 19857 19499 19858 23338 23337 K060935 31103 31844 31843 31532 38397	MANGUERA CALEFACCION MANGUERA CALEFACCION MANGUERA INF. MANGUERA INF. MANGUERA SUP. MANGUERA SUP. POLEA DEL TENSOR SERPENTIN TAPONES DE RADIADOR TENSOR TERMOSTATOS MANGUERA CALEFACCION MANGUERA CALEFACCION MANGUERA CALEFACCION MANGUERA INF. MANGUERA SUP. SERPENTIN TAPON DE ACEITE TAPON DE GASOLINA TAPON DE GASOLINA TAPONES DE RADIADOR TENSOR	CON 6 VEL. T.A. CON 4 VEL. T.A. CON 4 VEL. T.A. CON 6 VEL. T.A. CON 6 VEL. T.A. CON 4 VEL. T.A.  15 LBS.  180° TERMOSTATO A CALEF. CALEFACTOR AL TERMOSTA AL TERMOSTATO
	2009	19447 19447 23491 23431 23472 23021 36193 K050402 31532 38177 33943 19499 19857 19858 23338 23337 K060935 31103 31844 31843 31532 38397	MANGUERA CALEFACCION MANGUERA CALEFACCION MANGUERA INF. MANGUERA SUP. MANGUERA SUP. POLEA DEL TENSOR SERPENTIN TAPONES DE RADIADOR TENSOR TERMOSTATOS MANGUERA CALEFACCION MANGUERA CALEFACCION MANGUERA CALEFACCION MANGUERA INF. MANGUERA SUP. SERPENTIN TAPON DE ACEITE TAPON DE GASOLINA TAPON DE GASOLINA TAPONES DE RADIADOR TENSOR	CON 6 VEL. T.A. CON 4 VEL. T.A. CON 6 VEL. T.A. CON 4 VEL. T.A. CON 6 VEL. T.A. CON 4 VEL. T.A.  15 LBS.  180° CALEFACTOR AL TERMOSTA TERMOSTATO A CALEF. AL TERMOSTATO
	2008	19447 19447 23431 23491 23021 23472 36193 K050402 31532 38177 33943 19858 19857 19499 23338	MANGUERA CALEFACCION MANGUERA CALEFACCION MANGUERA INF. MANGUERA SUP. MANGUERA SUP. POLEA DEL TENSOR SERPENTIN TAPONES DE RADIADOR TENSOR TERMOSTATOS MANGUERA CALEFACCION MANGUERA CALEFACCION MANGUERA CALEFACCION MANGUERA INF. MANGUERA SUP.	CON 4 VEL. T.A. CON 6 VEL. T.A. CON 4 VEL. T.A. CON 6 VEL. T.A. CON 4 VEL. T.A. CON 6 VEL. T.A.  15 LBS.  180° AL TERMOSTATO TERMOSTATO A CALEF. CALEFACTOR AL TERMOSTA

**LUV**

4 CIL, 2.2 L	2003	7417 T1502 9380 9378 CH-140242 CH-140231	ALT. y VENTILADOR BANDA ARBOL DE LEVAS COMPRESOR DE AIRE D.H. MANG. INF. MANG. SUP.	V-6, 3.6 L
4 CIL, 2.2 L	2002	7417 T1502	ALT. y VENTILADOR BANDA ARBOL DE LEVAS	{148 D x 20 mm}







    				    					
V-6, 3.1 L	2001	31782 31532 38104 33329	TAPON DE GASOLINA TAPON DE RADIADOR TENSOR MICRO-V TERMOSTATO	CON LLAVE REGULAR (15 lbs) Sin palanca	4 CIL, 1.8 L	2007	TMV-14001 TPG-14004 T203 CH-149202 CH-149201 K050715 K050690 TPG-14004 TMV-14001	TENSOR TENSOR BANDA ARBOL DE LEVAS MANGUERA INF. MANGUERA SUP. SERPENTIN SERPENTIN TENSOR ARBOL DE LEVAS TENSOR PARA BANDA MICRO-V	
V-6, 3.1 L	2000	19049 19048 365370(919) 22524 22334 19026 38009 38006 K060868 31103 31636 31782 31532 38104 33329	CALEF. A TUBO-1 CALEF. A TUBO-2 EDH MANGUERA INF. MANGUERA SUP. PASO POLEA DEL TENSOR POLEA LOCA SERPENTIN TAPON DE ACEITE TAPON DE GASOLINA TAPON DE RADIADOR TAPON DE RADIADOR TENSOR MICRO-V TERMOSTATO	PRESION	4 CIL, 1.8 L	2006	T203 CH-149202 CH-149201 K050690 K050715 TPG-14004 TMV-14001	BANDA ARBOL DE LEVAS MANGUERA INF. MANGUERA SUP. SERPENTIN SERPENTIN TENSOR ARBOL DE LEVAS TENSOR PARA BANDA MICRO-V	ALT., C/AA ALT., S/AA
V-6, 3.1 L	1999	19049 19048 365370(919) 22334 22524 22332 19026 38009 38006 K060868 31103 31636 31782 31523 31532 38104 33329	CALEF. A TUBO-1 CALEF. A TUBO-2 EDH MANGUERA INF. MANGUERA INF. MANGUERA SUP. PASO POLEA DEL TENSOR POLEA LOCA SERPENTIN TAPON DE ACEITE TAPON DE GASOLINA TAPON DE GASOLINA TAPON DE RADIADOR TAPON DE RADIADOR TENSOR MICRO-V TERMOSTATO	PRESION 1er diseño 2do diseño	4 CIL, 1.8 L	2005	K050690 K050715 TPG-14004 TMV-14001	SERPENTIN SERPENTIN TENSOR ARBOL DE LEVAS TENSOR PARA BANDA MICRO-V	ALT., S/AA ALT., C/AA
<b>MONTE CARLO</b>									
4 CIL, 2.4 L	1998	80232 38011 K050474 31636 31782 38146 33828	EDH POLEA DEL TENSOR SERPENTIN TAPON DE GASOLINA TAPON DE GASOLINA TENSOR MICRO-V TERMOSTATO	SIN LLAVE REGULAR CON LLAVE REGULAR (16 lbs) Sin Palanca (15 lbs) Sin palanca	V-6, 3.8 L	2005	18020 19210 19211 19026 38001 K060703 31103 31636 31532 38105 33329 92041 38006 K060663 K060905	MANG. A TUBO-1 A VALV.DE AIF MANG. CALEF. A TUBO-1 MANG. CALEF. A TUBO-2 MANG. DE PASO POLEA SERPENTIN TAPON DE ACEITE TAPON DE GASOLINA TAPON DE RADIADOR TENSOR MICRO-V TERMOSTATO EDH POLEA TENSORA SERPENTIN SERPENTIN TAPON DE ACEITE	CORTAR A MEDIDA SIN LLAVE REGULAR (15 lbs) Sin palanca 195°F PRESION SUPER CARGADOR ACCESORIOS
V-6, 3.1 L	1998	365370(919) 19026 22332 38009 38006 K060868 31636 31782 38104 33329	EDH MANG. DE PASO MANG. SUP. POLEA DEL TENSOR POLEA LOCA SERPENTIN TAPON DE GASOLINA TAPON DE GASOLINA TENSOR MICRO-V TERMOSTATO	SIN LLAVE REGULAR CON LLAVE REGULAR	V-6, 3.4 L	2004	31103 31636 31532 33429 19210 19211 19026 38001 K060703 31103 31636 31532 38105 33329	TAPON DE ACEITE TAPON DE GASOLINA TAPON DE RADIADOR TERMOSTATO CALEF. A TUBO-1 CALEF. A TUBO-2 MANGUERA DE PASO POLEA SERPENTIN TAPON DE ACEITE TAPON DE GASOLINA TAPON DE RADIADOR	SIN LLAVE REGULAR (15 lbs) Sin palanca 195°F
4 CIL, 2.4 L	1997	80232 38011 K050474 31636 31782 38146 33828	EDH POLEA DEL TENSOR SERPENTIN TAPON DE GASOLINA TAPON DE GASOLINA TENSOR MICRO-V TERMOSTATO	SIN LLAVE REGULAR CON LLAVE REGULAR	V-6, 3.8 L	2004	18020 92041 38006 K060663 K060703 K060905	TUBO-1 A VALV. REG. DE AIRE EDH POLEA SERPENTIN SERPENTIN SERPENTIN TAPON DE ACEITE	195°F PRESION SUPER CARGADOR ACCESORIOS
V-6, 3.1 L	1997	365370(919) 38009 38006 31636 31782 38104 33329	EDH POLEA DEL TENSOR POLEA LOCA TAPON DE GASOLINA TAPON DE GASOLINA TENSOR MICRO-V TERMOSTATO	SIN LLAVE REGULAR CON LLAVE REGULAR	V-6, 3.1 L	2004	31103 31636 31532 33429	TAPON DE ACEITE TAPON DE GASOLINA TAPON DE RADIADOR TERMOSTATO	SIN LLAVE REGULAR (15 lbs) Sin palanca 195°F
<b>MONZA</b>									
4 CIL, 1.8 L	2008	T203 CH-149202 CH-149201 K050715 K050690	BANDA ARBOL DE LEVAS MANGUERA INF. MANGUERA SUP. SERPENTIN SERPENTIN	CON A.A. SIN A.A.	4 CIL, 1.6 L	2004	T203 6362GS TCK203 CH-140253 CH-140184 CH-140482 CH-140451 CH-140471 CH-140187	BANDA ARBOL DE LEVAS BANDA V KIT DE DISTRIBUCION MANG. B.A. MANG. DE CALEF. ENTRADA MANG. INF. MANG. SUP. MANG. SUP. MANG. TANQUE DE RECUP.	ALT. S/AA S/AA C/AA











**MERIVA**

4 CIL, 1.8 L	2008	T203 CH-149202 CH-149201 K050715 K050690	BANDA ARBOL DE LEVAS MANGUERA INF. MANGUERA SUP. SERPENTIN SERPENTIN	CON A.A. SIN A.A.
--------------	------	--	--	----------------------











									
4 CIL, 1.6 L	2004	CH-149203 T36038 K060708 K060570 31778 31734 TPG-14003 38200 13346	MANGUERA DE PASO POLEA LOCA SERPENTIN SERPENTIN TAPON DE GASOLINA TAPON DE GASOLINA SENSOR ARBOL DE LEVAS SENSOR MICRO-V TERMOSTATO	C/AA S/AA CON LLAVE REGULAR CON LLAVE C/CONT. DE EMI:	4 CIL, 1.6 L	1999	K060570 31734 31778 TPG-14003 38200 13346 T203 6362GS TCK203 CH-140253 CH-140184 CH-140482 CH-140471 CH-140451 CH-140187 CH-149203 T36038 K060708 K060570 31778 31734 TPG-14003 38200 13346	SERPENTIN TAPON DE GASOLINA TAPON DE GASOLINA SENSOR ARBOL DE LEVAS SENSOR MICRO-V TERMOSTATO BANDA ARBOL DE LEVAS BANDA V KIT DE DISTRIBUCION MANG. B.A. MANG. DE CALEF. ENTRADA MANG. INF. MANG. SUP. MANG. SUP. MANG. SUP. MANG. TANQUE DE RECUP. MANGUERA DE PASO POLEA LOCA SERPENTIN SERPENTIN TAPON DE GASOLINA TAPON DE GASOLINA SENSOR ARBOL DE LEVAS SENSOR MICRO-V TERMOSTATO	S/AA CON LLAVE C/CONT. DE EMI: CON LLAVE REGULAR 160°F ALT. S/AA
4 CIL, 1.6 L	2003	T203 6362GS TCK203 CH-140253 CH-140184 CH-140482 CH-140471 CH-140451 CH-140187 CH-149203 T36038 K060708 K060570 31778 31734 TPG-14003 38200 13346	BANDA ARBOL DE LEVAS BANDA V KIT DE DISTRIBUCION MANG. B.A. MANG. DE CALEF. ENTRADA MANG. INF. MANG. SUP. MANG. SUP. MANG. TANQUE DE RECUP. MANGUERA DE PASO POLEA LOCA SERPENTIN SERPENTIN TAPON DE GASOLINA TAPON DE GASOLINA SENSOR ARBOL DE LEVAS SENSOR MICRO-V TERMOSTATO	C/AA S/AA CON LLAVE REGULAR CON LLAVE C/CONT. DE EMI:	4 CIL, 1.6 L	1998	T203 6362GS TCK203 CH-140253 CH-140184 CH-140482 CH-140471 CH-140451 CH-140187 CH-149203 T36038 K060705 K060570 31734 31778 TPG-14003 38200 13346	BANDA ARBOL DE LEVAS BANDA V KIT DE DISTRIBUCION MANG. B.A. MANG. DE CALEF. ENTRADA MANG. INF. MANG. SUP. MANG. SUP. MANG. TANQUE DE RECUP. MANGUERA DE PASO POLEA LOCA SERPENTIN SERPENTIN TAPON DE GASOLINA TAPON DE GASOLINA SENSOR ARBOL DE LEVAS SENSOR MICRO-V TERMOSTATO	160°F ALT. S/AA C/AA S/AA C/AA S/AA CON LLAVE C/CONT. DE EMI: CON LLAVE REGULAR 160°F ALT. S/AA
4 CIL, 1.6 L	2002	T203 6362GS TCK203 CH-140253 CH-140184 CH-140482 CH-140451 CH-140471 CH-140187 CH-149203 T36038 K060570 K060705 31734 31778 TPG-14003 38200 13346	BANDA ARBOL DE LEVAS BANDA V KIT DE DISTRIBUCION MANG. B.A. MANG. DE CALEF. ENTRADA MANG. INF. MANG. SUP. MANG. SUP. MANG. TANQUE DE RECUP. MANGUERA DE PASO POLEA LOCA SERPENTIN SERPENTIN TAPON DE GASOLINA TAPON DE GASOLINA SENSOR ARBOL DE LEVAS SENSOR MICRO-V TERMOSTATO	S/AA C/AA CON LLAVE C/CONT. DE EMI: CON LLAVE REGULAR	4 CIL, 1.6 L	1997	T203 6362GS TCK203 CH-140253 CH-140184 CH-140482 CH-140451 CH-140471 CH-140187 CH-149203 T36038 K060570 K060705 31778 31734 TPG-14003 38200 13346	BANDA ARBOL DE LEVAS BANDA V KIT DE DISTRIBUCION MANG. B.A. MANG. DE CALEF. ENTRADA MANG. INF. MANG. SUP. MANG. SUP. MANG. TANQUE DE RECUP. MANGUERA DE PASO POLEA LOCA SERPENTIN SERPENTIN TAPON DE GASOLINA TAPON DE GASOLINA SENSOR ARBOL DE LEVAS SENSOR MICRO-V TERMOSTATO	160°F ALT. S/AA C/AA S/AA C/AA S/AA CON LLAVE C/CONT. DE EMI: CON LLAVE REGULAR 160°F ALT. S/AA
4 CIL, 1.6 L	2001	T203 6362GS TCK203 CH-140253 CH-140184 CH-140482 CH-140471 CH-140451 CH-140187 CH-149203 T36038 K060708 K060570 31778 31734 TPG-14003 38200 13346	BANDA ARBOL DE LEVAS BANDA V KIT DE DISTRIBUCION MANG. B.A. MANG. DE CALEF. ENTRADA MANG. INF. MANG. SUP. MANG. SUP. MANG. TANQUE DE RECUP. MANGUERA DE PASO POLEA LOCA SERPENTIN SERPENTIN TAPON DE GASOLINA TAPON DE GASOLINA SENSOR ARBOL DE LEVAS SENSOR MICRO-V TERMOSTATO	C/AA S/AA CON LLAVE C/CONT. DE EMI: CON LLAVE REGULAR	4 CIL, 1.6 L	2010	T309 TCK309 22914 22913 36152 K060744 31291 31844 31843 38200 TPG-14001 T309	BANDA ARBOL DE LEVAS KIT DE DISTRIBUCION MANGUERA INF. MANGUERA SUP. POLEA DEL TENSOR SERPENTIN TAPON DE ACEITE TAPON DE GASOLINA TAPON DE GASOLINA TENSOR TENSOR	S/AA C/AA CON LLAVE REGULAR CON LLAVE C/CONT. DE EMI: 160°F ALT. S/AA
4 CIL, 1.6 L	2000	T203 6362GS TCK203 CH-140253 CH-140184 CH-140482 CH-140471 CH-140451 CH-140187 CH-149203 T36038 K060705	BANDA ARBOL DE LEVAS BANDA V KIT DE DISTRIBUCION MANG. B.A. MANG. DE CALEF. ENTRADA MANG. INF. MANG. SUP. MANG. SUP. MANG. TANQUE DE RECUP. MANGUERA DE PASO POLEA LOCA SERPENTIN	C/AA S/AA CON LLAVE C/CONT. DE EMI:	4 CIL, 2.0 L	2009	T309 TCK309 22914 22913 36152 K060744 31291 31844 31843 38200 TPG-14001 T309	BANDA ARBOL DE LEVAS KIT DE DISTRIBUCION MANGUERA SUP. POLEA DEL TENSOR SERPENTIN TAPON DE ACEITE TAPON DE GASOLINA TAPON DE GASOLINA TENSOR TENSOR	169 D X 24.0 mm CON LLAVE 169 D X 24.0 mm











**OPTRA**











4 CIL. 2.0 L	2009	TCK309	KIT DE DISTRIBUCION	CON LLAVE	4 CIL. 2.2 L	2002	31782	TAPON DE GASOLINA	CON LLAVE REGULAR (16 lbs) Sin Palanca 195°F		
		22914	MANGUERA INF.				31528	TAPON DE RADIADOR			
		22913	MANGUERA SUP.				33429	TERMOSTATO			
		36152	POLEA DEL TENSOR				28469	CALEF. A TUBO-1		Re-usar el restrictor de flujo PRESION	
		K060744	SERPENTIN				19747	CALEF. A TUBO-2			
		31291	TAPON DE ACEITE				80053	EDH			
4 CIL. 2.0 L	2008	31844	TAPON DE GASOLINA	CON A/A	V-6, 4.3 L	2002	28466	MANG. CALEF. A TUBO-1	CORTAR A MEDIDA		
		31843	TAPON DE GASOLINA				22037	MANGUERA INF.			
		TPG-14001	TENSOR				22356	MANGUERA SUP.			
		38200	TENSOR				38015	POLEA DEL TENSOR			
		T309	BANDA ARBOL DE LEVAS				35B 3/8"	RECUPERADOR			
		TCK309	KIT DE DISTRIBUCION				K060637	SERPENTIN		S/A/A	
4 CIL. 2.0 L	2008	22914	MANGUERA INF.	CON A/A	V-6, 4.3 L	2002	K060744	SERPENTIN	C/A/A		
		22913	MANGUERA SUP.				31103	TAPON DE ACEITE	CON LLAVE REGULAR (16 lbs) Sin Palanca		
		36152	POLEA				31782	TAPON DE GASOLINA			
		K060744	SERPENTIN				31528	TAPON DE RADIADOR			
		38200	TENSOR MICRO-V				38165	TENSOR MICRO-V			
		36152	POLEA DEL TENSOR				33429	TERMOSTATO		195°F	
4 CIL. 2.0 L	2007	31291	TAPON DE ACEITE	CON LLAVE	V-6, 4.3 L	2002	30T 3/4"	TUBO-1 A B.A.		PRESION	
		31844	TAPON DE GASOLINA				18079	TUBO-1 A MOTOR			
		31843	TAPON DE GASOLINA				19070	CALEF. A BA			
		TPG-14001	TENSOR				19707	CALEF. A MOTOR			
		T309	BANDA ARBOL DE LEVAS				80276	EDH			
		TCK309	KIT DE DISTRIBUCION				22039	MANGUERA INF.			
4 CIL. 2.0 L	2007	22914	MANGUERA INF.	CON A/A	V-6, 4.3 L	2001	22196	MANGUERA SUP.	C/A/A S/A/A		
		22913	MANGUERA SUP.				19025	PASO			
		36152	POLEA				38001	POLEA LOCA LISA			
		K060744	SERPENTIN				K060950	SERPENTIN			
		38200	TENSOR MICRO-V				K060870	SERPENTIN			
		36152	POLEA DEL TENSOR				31103	TAPON DE ACEITE			
4 CIL. 2.0 L	2006	31291	TAPON DE ACEITE	CON LLAVE	V-6, 4.3 L	2001	31636	TAPON DE GASOLINA	SIN LLAVE REGULAR (16 lbs) Sin Palanca		
		31843	TAPON DE GASOLINA				31528	TAPON DE RADIADOR			
		31844	TAPON DE GASOLINA				38103	TENSOR MICRO-V			
		TPG-14001	TENSOR				33019	TERMOSTATO		195°F	
		T309	BANDA ARBOL DE LEVAS				19747	CALEF. A TUBO-2		Re-usar el restrictor de flujo PRESION	
		TCK309	KIT DE DISTRIBUCION				80053	EDH			
4 CIL. 2.0 L	2006	22914	MANGUERA INF.	CON A/A	V-6, 4.3 L	2001	22037	MANGUERA INF.	C/A/A S/A/A		
		22913	MANGUERA SUP.				22356	MANGUERA SUP.			
		36152	POLEA				38015	POLEA DEL TENSOR			
		K060744	SERPENTIN				K060744	SERPENTIN			
		38200	TENSOR MICRO-V				K060637	SERPENTIN			
		36152	POLEA DEL TENSOR				31103	TAPON DE ACEITE			
4 CIL. 2.0 L	2006	31291	TAPON DE ACEITE	CON LLAVE	V-6, 4.3 L	2001	31636	TAPON DE GASOLINA	SIN LLAVE REGULAR (16 lbs) Sin Palanca		
		31844	TAPON DE GASOLINA				31528	TAPON DE RADIADOR			
		31843	TAPON DE GASOLINA				38165	TENSOR MICRO-V			
		TPG-14001	TENSOR				33429	TERMOSTATO		195°F	
		T309	BANDA ARBOL DE LEVAS				18079	TUBO-1 A MOTOR			
		TCK309	KIT DE DISTRIBUCION				19070	CALEF. A BA			
P-30 V-6, 4.3 L	1999	K060966	SERPENTIN	CON LLAVE	V-6, 4.3 L	2001	19707	CALEF. A MOTOR	PRESION		
		K060960	SERPENTIN				80276	EDH			
		K060875	SERPENTIN				22039	MANGUERA INF.			
		K060870	SERPENTIN				22196	MANGUERA SUP.			
		33329	TERMOSTATO				19025	PASO			
		K060960	SERPENTIN				38008	POLEA DEL TENSOR			
		K060966	SERPENTIN				38001	POLEA LOCA			
		K060875	SERPENTIN				K060950	SERPENTIN		C/A/A	
		K060870	SERPENTIN				K060870	SERPENTIN		S/A/A	
		33329	TERMOSTATO				31103	TAPON DE ACEITE		SIN LLAVE REGULAR (16 lbs) Sin Palanca	
		K060966	SERPENTIN				31636	TAPON DE GASOLINA			
		K060960	SERPENTIN				31528	TAPON DE RADIADOR			
		K060875	SERPENTIN				38103	TENSOR MICRO-V			
K060870	SERPENTIN	33019	TERMOSTATO								
33329	TERMOSTATO	19747	CALEF. A TUBO-2	195°F							
V-8, 7.4 L V-6, 4.3 L	1997	80053	EDH	PRESION	V-6, 4.3 L	2000	19747	CALEF. A TUBO-2	Re-usar el restrictor de flujo PRESION		
		18079	MANG. A TUBO-1 A MOTOR				80053	EDH			
		28466	MANG. CALEF. A TUBO-1				22037	MANGUERA INF.			
		19747	MANG. CALEF. A TUBO-2				22356	MANGUERA SUP.			
		22037	MANG. INF.				38015	POLEA DEL TENSOR			
		22356	MANG. SUP.				K060637	SERPENTIN			
V-8, 7.4 L V-6, 4.3 L	1997	38015	POLEA LOCA	LISA	V-6, 4.3 L	2000	K060744	SERPENTIN	C/A/A		
		K060637	SERPENTIN				31103	TAPON DE ACEITE			
		K060744	SERPENTIN				31636	TAPON DE GASOLINA		SIN LLAVE REGULAR (16 lbs) Sin Palanca	
		31103	TAPON DE ACEITE				31528	TAPON DE RADIADOR			
		31636	TAPON DE GASOLINA				38165	TENSOR MICRO-V			
		31528	TAPON DE RADIADOR				33429	TERMOSTATO			195°F
38165	TENSOR MICRO-V	18079	TUBO-1 A MOTOR								
V-8, 7.4 L	1997	33329	TERMOSTATO	S/A/A	V-6, 4.3 L	2000	31103	TAPON DE ACEITE	SIN LLAVE REGULAR (16 lbs) Sin Palanca		
		K060966	SERPENTIN				31636	TAPON DE GASOLINA			
		K060960	SERPENTIN				31528	TAPON DE RADIADOR			
		K060875	SERPENTIN				38103	TENSOR MICRO-V			
		K060870	SERPENTIN				33019	TERMOSTATO			
		33329	TERMOSTATO				19747	CALEF. A TUBO-2		195°F	
S-10 4 CIL. 2.2 L	2003	80053	EDH	PRESION	4 CIL. 2.2 L	2000	22037	MANGUERA INF.	S/A/A C/A/A		
		18079	MANG. A TUBO-1 A MOTOR				22356	MANGUERA SUP.			
		28466	MANG. CALEF. A TUBO-1				38015	POLEA DEL TENSOR			
		19747	MANG. CALEF. A TUBO-2				K060637	SERPENTIN			
		22037	MANG. INF.				K060744	SERPENTIN			
		22356	MANG. SUP.				31103	TAPON DE ACEITE			
		38015	POLEA LOCA				31636	TAPON DE GASOLINA		SIN LLAVE REGULAR (16 lbs) Sin Palanca	
		K060637	SERPENTIN				31528	TAPON DE RADIADOR			
		K060744	SERPENTIN				38165	TENSOR MICRO-V			
		80053	EDH				33429	TERMOSTATO			
		18079	TUBO-1 A MOTOR				19747	TUBO-1 A MOTOR			195°F
		22037	MANGUERA INF.								











    				    					
V-6, 4.3 L	2000	19070 19707 80276 19025 22039 22196 38008 38001 K060950 K060870 31103 31636 31528 38103 33019	CALEF. A BA CALEF. A MOTOR EDH MANGUERA DE PASO MANGUERA INF. MANGUERA SUP. POLEA DEL TENSOR POLEA LOCA SERPENTIN SERPENTIN TAPON DE ACEITE TAPON DE GASOLINA TAPON DE RADIADOR TENSOR MICRO-V TENSOR MICRO-V	PRESION        C/AA S/AA  SIN LLAVE REGULAR (16 lbs) Sin Palanca S/AA 195°F	V-6, 4.3 L	1997	31528 38187 33429 80053 19025 22039 22196 38008 38001 K060950 K060870 31103 31636 31528 38103 33019	TAPON DE RADIADOR TENSOR MICRO-V TERMOSTATO EDH MANGUERA DE PASO MANGUERA INF. MANGUERA SUP. POLEA DEL TENSOR POLEA LOCA SERPENTIN SERPENTIN TAPON DE ACEITE TAPON DE GASOLINA TAPON DE RADIADOR TENSOR MICRO-V TERMOSTATO	(16 lbs) Sin Palanca  195°F PRESION      C/AA S/AA  SIN LLAVE REGULAR (16 lbs) Sin Palanca S/AA 195°F
4 CIL, 2.2 L	1999	19747 80053 22037 22356 38015 K060637 K060744 31103 31636 31528 38165 33429 18079	CALEF. A TUBO-2 EDH MANGUERA INF. MANGUERA SUP. POLEA DEL TENSOR SERPENTIN SERPENTIN TAPON DE ACEITE TAPON DE GASOLINA TAPON DE RADIADOR TENSOR MICRO-V TERMOSTATO TUBO-1 A MOTOR	Re-usar el restrictor de flujo PRESION      S/AA C/AA  SIN LLAVE REGULAR (16 lbs) Sin Palanca  195°F	<b>SILVERADO</b>				
V-6, 4.3 L	1999	19070 19707 80053 19025 22039 22196 38008 38001 K060950 K060870 31103 31636 31528 38103 33019	CALEF. A BA CALEF. A MOTOR EDH MANGUERA DE PASO MANGUERA INF. MANGUERA SUP. POLEA DEL TENSOR POLEA LOCA SERPENTIN SERPENTIN TAPON DE ACEITE TAPON DE GASOLINA TAPON DE RADIADOR TENSOR MICRO-V TENSOR MICRO-V	PRESION        C/AA S/AA  SIN LLAVE REGULAR (16 lbs) Sin Palanca S/AA 195°F	V-8, 4.8 L	2010	19025 23130 22435 38008 36299 38008 K060878 K060960 31103 31843 31844 31532 38103 33019 K040355SF 91030 22437 23184 36299 38009 K060935 31103 31843 31844 31532 39083 33808	MANGUERA DE PASO MANGUERA INF. MANGUERA SUP. POLEA POLEA POLEA DEL TENSOR SERPENTIN SERPENTIN TAPON DE ACEITE TAPON DE GASOLINA TAPON DE GASOLINA TAPONES DE RADIADOR TENSOR TERMOSTATOS A.A. STRECH FIT HERRAMIENTA INST. STRECH F MANGUERA INF. MANGUERA SUP. POLEA POLEA DEL TENSOR SERPENTIN TAPON DE ACEITE TAPON DE GASOLINA TAPON DE GASOLINA TAPONES DE RADIADOR TENSOR TERMOSTATOS A.A. STRECH FIT HERRAMIENTA INST. STRECH F MANGUERA INF. MANGUERA SUP. POLEA POLEA DEL TENSOR SERPENTIN TAPON DE ACEITE TAPON DE GASOLINA TAPON DE GASOLINA TAPONES DE RADIADOR TENSOR TERMOSTATOS MANGUERA DE PASO MANGUERA INF. MANGUERA SUP. POLEA POLEA POLEA DEL TENSOR SERPENTIN SERPENTIN TAPON DE ACEITE TAPON DE GASOLINA TAPON DE GASOLINA TAPONES DE RADIADOR TENSOR TERMOSTATOS MANGUERA DE PASO MANGUERA INF. MANGUERA SUP. POLEA POLEA POLEA DEL TENSOR SERPENTIN SERPENTIN TAPON DE ACEITE TAPON DE GASOLINA TAPON DE GASOLINA TAPONES DE RADIADOR TENSOR TERMOSTATOS A.A. STRECH FIT HERRAMIENTA INST. STRECH F	RANURADA SIN A.A. LISA  SIN A.A. CON A.A.  CON LLAVE 15 LBS.  195°   SERPENTIN  CON LLAVE 15 LBS. SERPENTIN 180°  SERPENTIN  CON LLAVE 15 LBS. SERPENTIN 180°  LISA RANURADA SIN A.A. SIN A.A. CON A.A.  CON LLAVE 15 LBS.  195°
4 CIL, 2.2 L	1998	80053 22037 22356 38015 K060637 K060744 31124 31636 31528 38165 33429	EDH MANGUERA INF. MANGUERA SUP. POLEA DEL TENSOR SERPENTIN SERPENTIN TAPON DE ACEITE TAPON DE GASOLINA TAPON DE RADIADOR TENSOR MICRO-V TERMOSTATO	PRESION      S/AA C/AA  SIN LLAVE REGULAR (16 lbs) Sin Palanca  195°F	V-8, 5.3 L	2010	K040355SF 91030 22437 23184 36299 38009 K060935 31103 31844 31843 31532 39083 33808	A.A. STRECH FIT HERRAMIENTA INST. STRECH F MANGUERA INF. MANGUERA SUP. POLEA POLEA DEL TENSOR SERPENTIN TAPON DE ACEITE TAPON DE GASOLINA TAPON DE GASOLINA TAPONES DE RADIADOR TENSOR TERMOSTATOS A.A. STRECH FIT HERRAMIENTA INST. STRECH F MANGUERA INF. MANGUERA SUP. POLEA POLEA DEL TENSOR SERPENTIN TAPON DE ACEITE TAPON DE GASOLINA TAPON DE GASOLINA TAPONES DE RADIADOR TENSOR TERMOSTATOS MANGUERA DE PASO MANGUERA INF. MANGUERA SUP. POLEA POLEA POLEA DEL TENSOR SERPENTIN SERPENTIN TAPON DE ACEITE TAPON DE GASOLINA TAPON DE GASOLINA TAPONES DE RADIADOR TENSOR TERMOSTATOS MANGUERA DE PASO MANGUERA INF. MANGUERA SUP. POLEA POLEA POLEA DEL TENSOR SERPENTIN SERPENTIN TAPON DE ACEITE TAPON DE GASOLINA TAPON DE GASOLINA TAPONES DE RADIADOR TENSOR TERMOSTATOS A.A. STRECH FIT HERRAMIENTA INST. STRECH F	SERPENTIN  CON LLAVE 15 LBS. SERPENTIN 180°  SERPENTIN  CON LLAVE 15 LBS. SERPENTIN 180°  LISA RANURADA SIN A.A. SIN A.A. CON A.A.  CON LLAVE 15 LBS.  195°
V-6, 4.3 L	1998	80053 19025 22039 22196 38008 38001 K060950 K060870 31103 31636 31528 38103 33019	EDH MANGUERA DE PASO MANGUERA INF. MANGUERA SUP. POLEA DEL TENSOR POLEA LOCA SERPENTIN SERPENTIN TAPON DE ACEITE TAPON DE GASOLINA TAPON DE RADIADOR TENSOR MICRO-V TENSOR MICRO-V	PRESION        C/AA S/AA  SIN LLAVE REGULAR (16 lbs) Sin Palanca S/AA 195°F	V-6, 4.3 L	2009	19025 23130 22435 36299 38008 38008 K060878 K060960 31103 31843 31844 31532 39083 33808 19025 23130 22435 36299 38008 38008 K060878 K060960 31103 31843 31844 31532 38103 33019	MANGUERA DE PASO MANGUERA INF. MANGUERA SUP. POLEA POLEA POLEA DEL TENSOR SERPENTIN SERPENTIN TAPON DE ACEITE TAPON DE GASOLINA TAPON DE GASOLINA TAPONES DE RADIADOR TENSOR TERMOSTATOS MANGUERA DE PASO MANGUERA INF. MANGUERA SUP. POLEA POLEA POLEA DEL TENSOR SERPENTIN SERPENTIN TAPON DE ACEITE TAPON DE GASOLINA TAPON DE GASOLINA TAPONES DE RADIADOR TENSOR TERMOSTATOS MANGUERA DE PASO MANGUERA INF. MANGUERA SUP. POLEA POLEA POLEA DEL TENSOR SERPENTIN SERPENTIN TAPON DE ACEITE TAPON DE GASOLINA TAPON DE GASOLINA TAPONES DE RADIADOR TENSOR TERMOSTATOS A.A. STRECH FIT HERRAMIENTA INST. STRECH F	CON LLAVE 15 LBS. SERPENTIN 180°  LISA RANURADA SIN A.A. SIN A.A. CON A.A.  CON LLAVE 15 LBS.  195°
4 CIL, 2.2 L	1997	80053 22037 21752 38001 K060653 K060755 31124 31636	EDH MANGUERA INF. MANGUERA SUP. POLEA DEL TENSOR SERPENTIN SERPENTIN TAPON DE ACEITE TAPON DE GASOLINA	PRESION      S/AA C/AA  SIN LLAVE REGULAR	V-8, 4.8 L	2009	K040355SF 91030	A.A. STRECH FIT HERRAMIENTA INST. STRECH F	195°



    				    					
V-8, 4.8 L	2009	22437 23184 36299 38009 K060935 31103 31844 31843 31532 39083 33808	MANGUERA INF. MANGUERA SUP. POLEA POLEA DEL TENSOR SERPENTIN TAPON DE ACEITE TAPON DE GASOLINA TAPON DE GASOLINA TAPONES DE RADIADOR TENSOR TERMOSTATOS	SERPENTIN  CON LLAVE  15 LBS. SERPENTIN 180°	V-8, 4.8 L	2007	38103 33019 18914 18122 22437 22436 38009 38001 K060923 K060930 K040378	TENSOR MICRO-V TERMOSTATO MANG. CALEF: A TERMOSTATO MANG. DE PASO MANG. INF. MANG. SUP. POLEA POLEA LOCA SERPENTIN SERPENTIN SERPENTIN	195°F CORTAR A MEDIDA CORTAR A MEDIDA     C/ALT DE 105 A C/ALT DE 130 A A.A.
V-8, 5.3 L	2009	K040355SF 91030 22437 23184 36299 38009 K060935 31103 31844 31843 31532 39083 33808	A.A. STRECH FIT HERRAMIENTA INST. STRECH F MANGUERA INF. MANGUERA SUP. POLEA POLEA DEL TENSOR SERPENTIN TAPON DE ACEITE TAPON DE GASOLINA TAPON DE GASOLINA TAPONES DE RADIADOR TENSOR TERMOSTATOS	SERPENTIN  CON LLAVE  15 LBS. SERPENTIN 180°	V-8, 5.3 L	2007	31103 31832 31532 38159 38158 33019 18914 18122 22437 22436 38009 38001 K060930 K060923 K040378	TAPON DE ACEITE TAPON DE GASOLINA TAPON DE RADIADOR TENSOR MICRO-V TENSOR MICRO-V TERMOSTATO MANG. CALEF: A TERMOSTATO MANG. DE PASO MANG. INF. MANG. SUP. POLEA POLEA LOCA SERPENTIN SERPENTIN SERPENTIN	SIN LLAVE REGULAR (15 lbs) Sin palanca A.A. SERPENTIN 195°F CORTAR A MEDIDA CORTAR A MEDIDA
V-6, 4.3 L	2008	19025 23130 22435 38008 36299 38008 K060878 K060960 31103 31843 31844 31532 38103 33019 K040378	MANGUERA DE PASO MANGUERA INF. MANGUERA SUP. POLEA POLEA POLEA DEL TENSOR SERPENTIN SERPENTIN TAPON DE ACEITE TAPON DE GASOLINA TAPON DE GASOLINA TAPONES DE RADIADOR TENSOR TERMOSTATOS A.A.	RANURADA SIN A.A. LISA  SIN A.A. CON A.A.  CON LLAVE 15 LBS.  195°	V-8, 6.0 L	2007	80332 18914 18122 22437 22436 38009 38001 K060930 K060923 K040378	EDH MANG. CALEF: A TERMOSTATO MANG. DE PASO MANG. INF. MANG. SUP. POLEA POLEA LOCA SERPENTIN SERPENTIN SERPENTIN	PRESION CORTAR A MEDIDA CORTAR A MEDIDA    C/ALT DE 130 A C/ALT DE 105 A A.A.
V-8, 4.8 L	2008	22437 23184 36299 38009 36169 K060935 31103 31843 31844 31532 38158 38159 33963	MANGUERA INF. MANGUERA SUP. POLEA POLEA DEL TENSOR POLEA DEL TENSOR SERPENTIN TAPON DE ACEITE TAPON DE GASOLINA TAPON DE GASOLINA TAPONES DE RADIADOR TENSOR TENSOR TERMOSTATOS	SERPENTIN  A.A.  SERPENTIN A.A.  CON LLAVE 15 LBS. SERPENTIN A.A.  186°	V-8, 6.6 L	2007	22698 38008 38009 38001 K060956 K060950 K040400	MANG. SUP. POLEA POLEA LOCA SERPENTIN SERPENTIN SERPENTIN	SIN LLAVE REGULAR (15 lbs) Sin palanca A.A. SERPENTIN 180°F
V-8, 5.3 L	2008	K040378 22437 23184 36299 38009 36169 K060935 31103 31844 31843 31532 38158 38159 33963	A.A. MANGUERA INF. MANGUERA SUP. POLEA POLEA DEL TENSOR POLEA DEL TENSOR SERPENTIN TAPON DE ACEITE TAPON DE GASOLINA TAPON DE GASOLINA TAPONES DE RADIADOR TENSOR TENSOR TERMOSTATOS	SERPENTIN  A.A.  SERPENTIN A.A.  CON LLAVE 15 LBS. SERPENTIN A.A.  186°	V-8, 8.1 L	2007	38009 38001 K060956 K060950 K040400	POLEA POLEA LOCA SERPENTIN SERPENTIN SERPENTIN	LISA C/ALT DE 130 A C/ALT 105 A A.A.
V-8, 5.3 L	2008	K040378 22437 23184 36299 38009 36169 K060935 31103 31844 31843 31532 38158 38159 33963	A.A. MANGUERA INF. MANGUERA SUP. POLEA POLEA DEL TENSOR POLEA DEL TENSOR SERPENTIN TAPON DE ACEITE TAPON DE GASOLINA TAPON DE GASOLINA TAPONES DE RADIADOR TENSOR TENSOR TERMOSTATOS	SERPENTIN  A.A.  SERPENTIN A.A.  CON LLAVE 15 LBS. SERPENTIN A.A.  186°	V-8, 4.8 L	2006	18914 18122 22437 22436 38009 38001 K060923 K060930 K040378	MANG. CALEF: A TERMOSTATO MANG. DE PASO MANG. INF. MANG. SUP. POLEA POLEA LOCA SERPENTIN SERPENTIN SERPENTIN	195°F CORTAR A MEDIDA CORTAR A MEDIDA
V-6, 4.3 L	2007	19025 22438 22435 38001 K060950 K060868 31103 31832 31532 31532	MANG. DE PASO MANG. INF. MANG. SUP. POLEA LOCA SERPENTIN SERPENTIN TAPON DE ACEITE TAPON DE GASOLINA TAPON DE GASOLINA TAPON DE RADIADOR	LISA C/AA S/AA  SIN LLAVE REGULAR (15 lbs) Sin palanca	V-8, 4.8 L	2006	38158 18914 18122 22437 22436 38009 38001 K060923 K060930 K040378	TENSOR MICRO-V MANG. CALEF: A TERMOSTATO MANG. DE PASO MANG. INF. MANG. SUP. POLEA POLEA LOCA SERPENTIN SERPENTIN SERPENTIN	SIN LLAVE REGULAR (15 lbs) Sin palanca SERPENTIN

    				    				
V-8, 4.8 L	2006	38159 33019	TENSOR MICRO-V TERMOSTATO	A.A. 195°F		18122 22437	MANG. DE PASO MANG. INF.	CORTAR A MEDIDA
V-8, 5.3 L	2006	18914 18122 22437 22436 38009 38001 K060930 K060923 K040378 38159 38158	MANG. CALEF: A TERMOSTATO MANG. DE PASO MANG. INF. MANG. SUP. POLEA POLEA LOCA SERPENTIN SERPENTIN SERPENTIN TENSOR MICRO-V TENSOR MICRO-V	CORTAR A MEDIDA CORTAR A MEDIDA C/ALT 130A C/ALT 105A A.A. A.A. SERPENTIN		38009 38001 K060930 K060923 K040378 38159 38158 33910	POLEA POLEA LOCA SERPENTIN SERPENTIN SERPENTIN TAPON DE ACEITE TAPON DE GASOLINA TAPON DE RADIADOR TENSOR MICRO-V TENSOR MICRO-V TERMOSTATO	C/ALT 130A C/ALT 105A A.A. A.A. A.A. 180°F
V-8, 6.0 L	2006	80332 18914 18122 22437 22436 38009 38001 K060930 K060923 K040378 31103 31832 31532 38159 38158 33910	EDH MANG. CALEF: A TERMOSTATO MANG. DE PASO MANG. INF. MANG. SUP. POLEA POLEA LOCA SERPENTIN SERPENTIN SERPENTIN TAPON DE ACEITE TAPON DE GASOLINA TAPON DE RADIADOR TENSOR MICRO-V TENSOR MICRO-V TERMOSTATO	PRESION CORTAR A MEDIDA CORTAR A MEDIDA C/ALT 130A C/ALT 105A A.A. SIN LLAVE REGULAR (15 lbs) Sin palanca A.A. SERPENTIN 180°F	V-8, 6.6 L V-8, 8.1 L	22698 38008 38009 38001 K060950 K060956 K040400 19025 22438 22435 38001 K060950 K060868 31103 31832 31532 38103 33019	MANG. SUP. POLEA POLEA POLEA LOCA SERPENTIN SERPENTIN SERPENTIN MANG. DE PASO MANG. INF. MANG. SUP. POLEA LOCA SERPENTIN SERPENTIN SERPENTIN TAPON DE ACEITE TAPON DE GASOLINA TAPON DE RADIADOR TENSOR MICRO-V TENSOR MICRO-V TERMOSTATO	LISA C/ALT 105A C/ALT 130A A.A. LISA C/AA S/AA SIN LLAVE REGULAR (15 lbs) Sin palanca 195°F
V-8, 6.6 L	2006	22698 38008	MANG. SUP. POLEA			31832 31532 38103 33019	TAPON DE GASOLINA TAPON DE RADIADOR TENSOR MICRO-V TENSOR MICRO-V TERMOSTATO	SIN LLAVE REGULAR (15 lbs) Sin palanca
V-8, 8.1 L	2006	38009 38001 K060950 K060956 K040400	POLEA POLEA LOCA SERPENTIN SERPENTIN SERPENTIN	LISA C/ALT 105A C/ALT 130A A.A.	V-8, 4.8 L	18914 18122 22437 22436 38009 38001 K060930 K060923 K040378 31103 31832 31532 38159 38158 33019	MANG. CALEF: A TERMOSTATO MANG. DE PASO MANG. INF. MANG. SUP. POLEA POLEA LOCA SERPENTIN SERPENTIN SERPENTIN TAPON DE ACEITE TAPON DE GASOLINA TAPON DE RADIADOR TENSOR MICRO-V TENSOR MICRO-V TERMOSTATO	CORTAR A MEDIDA CORTAR A MEDIDA
V-6, 4.3 L	2005	19025 22438 22435 38001 K060950 K060868 31103 31832 31532 38103 33019	MANG. DE PASO MANG. INF. MANG. SUP. POLEA LOCA SERPENTIN SERPENTIN SERPENTIN TAPON DE ACEITE TAPON DE GASOLINA TAPON DE RADIADOR TENSOR MICRO-V TENSOR MICRO-V TERMOSTATO	LISA C/AA S/AA SIN LLAVE REGULAR (15 lbs) Sin palanca 195°F		18914 18122 22437 22436 38009 38001 K060930 K060923 K040378 31103 31832 31532 38159 38158 33019	MANG. DE PASO MANG. INF. MANG. SUP. POLEA POLEA LOCA SERPENTIN SERPENTIN SERPENTIN TAPON DE ACEITE TAPON DE GASOLINA TAPON DE RADIADOR TENSOR MICRO-V TENSOR MICRO-V TERMOSTATO	C/ALT 130A C/ALT 105A A.A. SIN LLAVE REGULAR (15 lbs) Sin palanca 195°F
V-8, 4.8 L	2005	18914 18122 22437 22436 38009 38001 K060930 K060923 K040378 31103 31832 31532 38159 38158 33019	MANG. CALEF: A TERMOSTATO MANG. DE PASO MANG. INF. MANG. SUP. POLEA POLEA LOCA SERPENTIN SERPENTIN SERPENTIN TAPON DE ACEITE TAPON DE GASOLINA TAPON DE RADIADOR TENSOR MICRO-V TENSOR MICRO-V TERMOSTATO	CORTAR A MEDIDA CORTAR A MEDIDA C/ALT 130A C/ALT 105A A.A. C/ALT 130A C/ALT 105A A.A.	V-8, 5.3 L	18914 18122 22437 22436 38009 38001 K060930 K060923 K040378 31103 31832 31532 38159 38158 33019	MANG. CALEF: A TERMOSTATO MANG. DE PASO MANG. INF. MANG. SUP. POLEA POLEA LOCA SERPENTIN SERPENTIN SERPENTIN TAPON DE ACEITE TAPON DE GASOLINA TAPON DE RADIADOR TENSOR MICRO-V TENSOR MICRO-V TERMOSTATO	CORTAR A MEDIDA CORTAR A MEDIDA
V-8, 5.3 L	2005	18914 18122 22437 22436 38009 38001 K060930 K060923 K040378 31103 31832 31532 38159 38158 33019	MANG. CALEF: A TERMOSTATO MANG. DE PASO MANG. INF. MANG. SUP. POLEA POLEA LOCA SERPENTIN SERPENTIN SERPENTIN TAPON DE ACEITE TAPON DE GASOLINA TAPON DE RADIADOR TENSOR MICRO-V TENSOR MICRO-V TERMOSTATO	CORTAR A MEDIDA CORTAR A MEDIDA C/ALT 130A C/ALT 105A A.A. C/ALT 130A C/ALT 105A A.A.	V-8, 6.0 L	18914 18122 22437 22436 38009 38001 K060930 K060923 K040378 31103 31832 31532 38159 38158 33019	MANG. CALEF: A TERMOSTATO MANG. DE PASO MANG. INF. MANG. SUP. POLEA POLEA LOCA SERPENTIN SERPENTIN SERPENTIN TAPON DE ACEITE TAPON DE GASOLINA TAPON DE RADIADOR TENSOR MICRO-V TENSOR MICRO-V TERMOSTATO	CORTAR A MEDIDA CORTAR A MEDIDA
V-8, 6.0 L	2005	80332 18914 18122	EDH MANG. CALEF: A TERMOSTATO MANG. DE PASO	PRESION CORTAR A MEDIDA CORTAR A MEDIDA	V-8, 6.6 L	22698 38008 38009 38001 K060950 K060956 K040400 19025 22438 22435 38001 K060950 K060868 31103 31832 31532 38103 33019	MANG. SUP. POLEA POLEA POLEA LOCA SERPENTIN SERPENTIN SERPENTIN MANG. DE PASO MANG. INF. MANG. SUP. POLEA LOCA SERPENTIN SERPENTIN SERPENTIN TAPON DE ACEITE TAPON DE GASOLINA TAPON DE RADIADOR TENSOR MICRO-V TENSOR MICRO-V TERMOSTATO	LISA C/ALT 105A C/ALT 130A A.A. LISA C/AA S/AA SIN LLAVE REGULAR (15 lbs) Sin palanca 195°F

    				    					
V-8, 6.6 L	2004	38008	POLEA		V-6, 4.3 L	2002	22438	MANGUERA INF.	
V-8, 8.1 L		38009	POLEA				22435	MANGUERA SUP.	
		38001	POLEA LOCA	LISA			19025	PASO	
		K060956	SERPENTIN	C/ALT 130A			38001	POLEA LOCA LISA	
		K060950	SERPENTIN	C/ALT 105A			K060950	SERPENTIN	C/AA
		K040400	SERPENTIN	A.A.			K060868	SERPENTIN	S/AA
V-6, 4.3 L	2003	19025	MANG. DE PASO				31103	TAPON DE ACEITE	
		22438	MANG. INF.				31780	TAPON DE GASOLINA	CON LLAVE REGULAR
		22435	MANG. SUP.				31832	TAPON DE GASOLINA	SIN LLAVE REGULAR
		38001	POLEA LOCA	LISA			31532	TAPON DE RADIADOR	(15 lbs) Sin palanca
		K060950	SERPENTIN	C/AA			38103	SENSOR MICRO-V	
		K060868	SERPENTIN	S/AA			33019	TERMOSTATO	195°F
		31103	TAPON DE ACEITE		V-8, 4.8 L	2002	K040378	A.A.	
		31780	TAPON DE GASOLINA	CON LLAVE REGULAR			18914	CALEF. A TERMOSTATO	
		31832	TAPON DE GASOLINA	SIN LLAVE REGULAR			22437	MANGUERA INF.	
		31532	TAPON DE RADIADOR	(15 lbs) Sin palanca			22436	MANGUERA SUP.	
		38103	SENSOR MICRO-V				18122	PASO	
		33019	TERMOSTATO	195°F			38009	POLEA DEL TENSOR	
V-8, 4.8 L	2003	18914	MANG. CALEF: A TERMOSTATO	CORTAR A MEDIDA			38001	POLEA LOCA	
		18122	MANG. DE PASO	CORTAR A MEDIDA			K060923	SERPENTIN	C/Alt de 105A.
		22437	MANG. INF.				K060930	SERPENTIN	C/Alt de 130A.
		22436	MANG. SUP.				31103	TAPON DE ACEITE	
		38009	POLEA				31780	TAPON DE GASOLINA	CON LLAVE REGULAR
		38001	POLEA LOCA				31832	TAPON DE GASOLINA	SIN LLAVE REGULAR
		K060930	SERPENTIN	C/ALT 130A			31532	TAPON DE RADIADOR	(15 lbs) Sin palanca
		K060923	SERPENTIN	C/ALT 105A			38158	SENSOR MICRO-V	
		K040378	SERPENTIN	A.A.			38159	SENSOR MICRO-V	
		31103	TAPON DE ACEITE				33019	TERMOSTATO	195°F
		31780	TAPON DE GASOLINA	CON LLAVE REGULAR	V-8, 5.3 L	2002	K040378	A.A.	
		31832	TAPON DE GASOLINA	SIN LLAVE REGULAR			18914	CALEF. A TERMOSTATO	
		31532	TAPON DE RADIADOR	(15 lbs) Sin palanca			22437	MANGUERA INF.	
		38158	SENSOR MICRO-V	SERPENTIN			22436	MANGUERA SUP.	
		38159	SENSOR MICRO-V	A.A.			18122	PASO	
		33019	TERMOSTATO	195°F			38009	POLEA DEL TENSOR	
V-8, 5.3 L	2003	18914	MANG. CALEF: A TERMOSTATO	CORTAR A MEDIDA			38001	POLEA LOCA	
		18122	MANG. DE PASO	CORTAR A MEDIDA			K060930	SERPENTIN	C/Alt de 130A.
		22437	MANG. INF.				K060923	SERPENTIN	C/Alt de 105A.
		22436	MANG. SUP.				31780	TAPON DE GASOLINA	CON LLAVE REGULAR
		38009	POLEA				31832	TAPON DE GASOLINA	SIN LLAVE REGULAR
		38001	POLEA LOCA				38159	SENSOR MICRO-V	
		K060930	SERPENTIN	C/ALT 130A			38158	SENSOR MICRO-V	
		K060923	SERPENTIN	C/ALT 105A	V-8, 6.0 L	2002	K040378	A.A.	
		K040378	SERPENTIN	A.A.			18914	CALEF. A TERMOSTATO	
		31780	TAPON DE GASOLINA	CON LLAVE REGULAR			80332	EDH	PRESION
		31832	TAPON DE GASOLINA	SIN LLAVE REGULAR			22437	MANGUERA INF.	
		38159	SENSOR MICRO-V	A.A.			22436	MANGUERA SUP.	
		38158	SENSOR MICRO-V	SERPENTIN			18122	PASO	
V-8, 6.0 L	2003	80332	EDH	PRESION			38009	POLEA DEL TENSOR	
		18914	MANG. CALEF: A TERMOSTATO	CORTAR A MEDIDA			38001	POLEA LOCA	
		18122	MANG. DE PASO	CORTAR A MEDIDA			K060923	SERPENTIN	C/Alt de 105A.
		22437	MANG. INF.				K060930	SERPENTIN	C/Alt de 130A.
		22436	MANG. SUP.				31103	TAPON DE ACEITE	
		38009	POLEA				31832	TAPON DE GASOLINA	SIN LLAVE REGULAR
		38001	POLEA LOCA				31780	TAPON DE GASOLINA	CON LLAVE REGULAR
		K060930	SERPENTIN	C/ALT 130A			31532	TAPON DE RADIADOR	(15 lbs) Sin palanca
		K060923	SERPENTIN	C/ALT 105A			38158	SENSOR MICRO-V	
		K040378	SERPENTIN	A.A.			38159	SENSOR MICRO-V	
		31103	TAPON DE ACEITE				33910	TERMOSTATO	180°F
		31780	TAPON DE GASOLINA	CON LLAVE REGULAR	V-8, 6.6 L	2002	22698	MANGUERA SUP.	
		31832	TAPON DE GASOLINA	SIN LLAVE REGULAR			38008	POLEA DEL TENSOR	
		31532	TAPON DE RADIADOR	(15 lbs) Sin palanca			31832	TAPON DE GASOLINA	SIN LLAVE REGULAR
		38159	SENSOR MICRO-V	A.A.			31780	TAPON DE GASOLINA	CON LLAVE REGULAR
		38158	SENSOR MICRO-V	SERPENTIN	V-8, 8.1 L	2002	K040400	A.A.	
		33910	TERMOSTATO	180°F			38009	POLEA DEL TENSOR	
V-8, 6.6 L	2003	22698	MANG. SUP.				38001	POLEA LOCA LISA	
		38008	POLEA				K060956	SERPENTIN	C/Alt de 130A.
		31832	TAPON DE GASOLINA	SIN LLAVE REGULAR			K060950	SERPENTIN	C/Alt de 105A.
		31780	TAPON DE GASOLINA	CON LLAVE REGULAR			31780	TAPON DE GASOLINA	CON LLAVE REGULAR
V-8, 8.1 L	2003	38009	POLEA				31832	TAPON DE GASOLINA	SIN LLAVE REGULAR
		38001	POLEA LOCA	LISA	V-6, 4.3 L	2001	22438	MANGUERA INF.	
		K060956	SERPENTIN	C/ALT 130A			22435	MANGUERA SUP.	
		K060950	SERPENTIN	C/ALT 105A			19025	PASO	
		K040400	SERPENTIN	A.A.			38008	POLEA DEL TENSOR	
		31832	TAPON DE GASOLINA	SIN LLAVE REGULAR			38008	POLEA LOCA	S/AA
		31780	TAPON DE GASOLINA	CON LLAVE REGULAR			38001	POLEA LOCA LISA	

    				    					
V-6, 4.3 L	2001	K060950 K060868 31103 31832 31780 31532 38103 33019	SERPENTIN SERPENTIN TAPON DE ACEITE TAPON DE GASOLINA TAPON DE GASOLINA TAPON DE RADIADOR TENSOR MICRO-V TERMOSTATO	C/AA S/AA  SIN LLAVE REGULAR CON LLAVE REGULAR (15 lbs) Sin palanca S/AA 195°F	V-6, 4.3 L	2000	31832 31780 31532 33329 353190(803) 22438 22435 19025 38008 38001 K060950 K060868 31103 31780 31832 31532 38103 33019	TAPON DE GASOLINA TAPON DE GASOLINA TAPON DE RADIADOR TERMOSTATO EDH MANGUERA INF. MANGUERA SUP. PASO POLEA DEL TENSOR POLEA LOCA SERPENTIN SERPENTIN TAPON DE ACEITE TAPON DE GASOLINA TAPON DE GASOLINA TAPON DE RADIADOR TENSOR MICRO-V TERMOSTATO	SIN LLAVE REGULAR CON LLAVE REGULAR (15 lbs) Sin palanca 195°F PRESION
V-8, 4.8 L	2001	K040378 18914 22437 22436 18122 38009 38001 K060923 K060930 K040378 31780 31832 38158 38159	A.A. CALEF. A TERMOSTATO MANGUERA INF. MANGUERA SUP. PASO POLEA DEL TENSOR POLEA LOCA SERPENTIN SERPENTIN SERPENTIN TAPON DE GASOLINA TAPON DE GASOLINA TENSOR MICRO-V TENSOR MICRO-V	C/Alt de 105A. C/Alt de 130A. A.A. CON LLAVE REGULAR SIN LLAVE REGULAR	V-8, 4.8 L  V-8, 5.3 L	2000	31780 31832 K040378 18914 353190(803) 22437 22436 18122 38009 38001 K060923 K060930 31103 31780 31832 31532 38158 38159 33019	TAPON DE GASOLINA TAPON DE GASOLINA A.A. CALEF. A TERMOSTATO EDH MANGUERA INF. MANGUERA SUP. PASO POLEA DEL TENSOR POLEA LOCA SERPENTIN SERPENTIN TAPON DE ACEITE TAPON DE GASOLINA TAPON DE GASOLINA TAPON DE RADIADOR TENSOR MICRO-V TENSOR MICRO-V TERMOSTATO	C/AA, C/DH S/AA, C/DH  CON LLAVE REGULAR SIN LLAVE REGULAR (15 lbs) Sin palanca S/AA 195°F CON LLAVE REGULAR SIN LLAVE REGULAR
V-8, 5.3 L	2001	K040378 18914 353190(803) 22437 22436 18122 38009 38001 K060930 K060923 31103 31780 31832 31532 38159 38158 33910	A.A. CALEF. A TERMOSTATO EDH MANGUERA INF. MANGUERA SUP. PASO POLEA DEL TENSOR POLEA LOCA SERPENTIN SERPENTIN TAPON DE ACEITE TAPON DE GASOLINA TAPON DE GASOLINA TAPON DE RADIADOR TENSOR MICRO-V TENSOR MICRO-V TERMOSTATO	PRESION  C/Alt de 130A. C/Alt de 105A.  CON LLAVE REGULAR SIN LLAVE REGULAR (15 lbs) Sin palanca	V-8, 6.0 L	2000	K040378 18914 353190(803) 22437 22436 18122 38009 38001 K060923 K060930 31103 31780 31832 31532 38158 38159 33019	A.A. CALEF. A TERMOSTATO EDH MANGUERA INF. MANGUERA SUP. PASO POLEA DEL TENSOR POLEA LOCA SERPENTIN SERPENTIN TAPON DE ACEITE TAPON DE GASOLINA TAPON DE GASOLINA TAPON DE RADIADOR TENSOR MICRO-V TENSOR MICRO-V TERMOSTATO	PRESION  C/Alt de 100A., 105A. C/Alt de 130A. CON LLAVE REGULAR SIN LLAVE REGULAR (15 lbs) Sin palanca  195°F
V-8, 6.0 L	2001	K040378 18914 353190(803) 22437 22436 18122 38009 38001 K060930 K060923 31780 31832 31532 38158 38159 33910	A.A. CALEF. A TERMOSTATO EDH MANGUERA INF. MANGUERA SUP. PASO POLEA DEL TENSOR POLEA LOCA SERPENTIN SERPENTIN TAPON DE GASOLINA TAPON DE GASOLINA TAPON DE RADIADOR TENSOR MICRO-V TENSOR MICRO-V TERMOSTATO	C/Alt de 130A. C/Alt de 105A. CON LLAVE REGULAR SIN LLAVE REGULAR (15 lbs) Sin palanca	V-8, 6.6 L	2000	K040378 18914 353190(803) 22437 22436 18122 38009 38001 K060923 K060930 31832 31780 31532 38158 38159 33019	A.A. CALEF. A TERMOSTATO EDH MANGUERA INF. MANGUERA SUP. PASO POLEA DEL TENSOR POLEA LOCA SERPENTIN SERPENTIN TAPON DE GASOLINA TAPON DE GASOLINA TAPON DE RADIADOR TENSOR MICRO-V TENSOR MICRO-V TERMOSTATO	C/Alt de 100A., 105A. C/Alt de 130A. SIN LLAVE REGULAR CON LLAVE REGULAR (15 lbs) Sin palanca  195°F SIN LLAVE REGULAR CON LLAVE REGULAR
V-8, 6.6 L	2001	92083 22698 38006 38008 K061123 K061114 31103 31832 31835 31780 31532 38136 33946	EDH MANGUERA SUP. POLEA DEL TENSOR POLEA LOCA SERPENTIN SERPENTIN TAPON DE ACEITE TAPON DE GASOLINA TAPON DE GASOLINA TAPON DE GASOLINA TAPON DE RADIADOR TENSOR MICRO-V TERMOSTATO	PRESION, HYDROBOOSTER V-8, 8.1 L	V-8, 8.1 L	2000	31780 31832 353190(803) 22438 22435 19025 38008 38001 K060950 K060868 31103 31832 31532 38103 33019	TAPON DE GASOLINA TAPON DE GASOLINA EDH MANGUERA INF. MANGUERA SUP. PASO POLEA DEL TENSOR POLEA LOCA SERPENTIN SERPENTIN TAPON DE ACEITE TAPON DE GASOLINA TAPON DE RADIADOR TENSOR MICRO-V TERMOSTATO	SIN LLAVE REGULAR CON LLAVE REGULAR SIN LLAVE REGULAR PRESION
V-8, 8.1 L	2001	K040400 92043 38009 38001 K060950 K060956 31099	A.A. EDH POLEA DEL TENSOR POLEA LOCA LISA SERPENTIN SERPENTIN TAPON DE ACEITE	PRESION, BOMBA A HYDROE	V-8, 5.3 L	2003	92092 22437	EDH MANGUERA INF.	PRESION HYDROBOOSTER /











**SONORA**

V-8, 5.3 L	2003	22436	MANGUERA SUP.								
		K060923	SERPENTIN	ALT. C/105 AMP	V-8, 6.0 L	2008	33963	TERMOSTATOS		186°	
		K060930	SERPENTIN	ALT. C/145 AMP			K040378	A.A.			
		K040378	SERPENTIN	C/AA			22437	MANGUERA INF.			
		31103	TAPON DE ACEITE				23184	MANGUERA SUP.			
		31843	TAPON DE GASOLINA	SIN LLAVE REGULAR			36299	POLEA			
		31532	TAPON DE RADIADOR	(15 lbs) Sin palanca			36169	POLEA DEL TENSOR		A.A.	
							38009	POLEA DEL TENSOR		SERPENTIN	









## SUBURBAN

V-8, 5.3 L	2010	K040355SF	A.A. STRECH FIT		V-8, 5.3 L	2007	92092	EDH		PRESION HYDROBOOSTER /
		91030	HERRAMIENTA INST. STRECH F				22437	MANG. INF.		
		22437	MANGUERA INF.				22436	MANG. SUP.		
		23184	MANGUERA SUP.				38001	POLEA		SERPENTIN
		36299	POLEA				38009	POLEA		SERPENTIN
		38009	POLEA DEL TENSOR	SERPENTIN			K060923	SERPENTIN		ALT. C/105 AMP
		K060935	SERPENTIN				K060930	SERPENTIN		ALT. C/145 AMP
		31103	TAPON DE ACEITE				K040378	SERPENTIN		C/AA
		31844	TAPON DE GASOLINA	CON LLAVE			31103	TAPON DE ACEITE		
		31843	TAPON DE GASOLINA				31843	TAPON DE GASOLINA		SIN LLAVE REGULAR
		31532	TAPONES DE RADIADOR	15 LBS.			31532	TAPON DE RADIADOR		(15 lbs) Sin palanca
		39083	SENSOR	SERPENTIN			38158	SENSOR MICRO-V		SERPENTIN
		33808	TERMOSTATOS	180°			38159	SENSOR MICRO-V		A.A.
V-8, 6.0 L	2010	K040355SF	A.A. STRECH FIT		V-8, 6.0 L	2007	K040378	A.A.		
		91030	HERRAMIENTA INST. STRECH F				22554	MANGUERA CALEFACCION		CALEFACTOR AL TERMOSTA/
		22437	MANGUERA INF.				22437	MANGUERA INF.		
		23184	MANGUERA SUP.				23184	MANGUERA SUP.		
		36299	POLEA				38009	POLEA		SERPENTIN
		38009	POLEA DEL TENSOR	SERPENTIN			38001	POLEA		SERPENTIN
		K060935	SERPENTIN				K060930	SERPENTIN		C/ALT. 145 A.
		31103	TAPON DE ACEITE				K060923	SERPENTIN		C/ALT. 105 A.
		31843	TAPON DE GASOLINA				31103	TAPON DE ACEITE		
		31844	TAPON DE GASOLINA	CON LLAVE			31844	TAPON DE GASOLINA		CON LLAVE
		31532	TAPONES DE RADIADOR	15 LBS.			31843	TAPON DE GASOLINA		
		39083	SENSOR	SERPENTIN			31532	TAPONES DE RADIADOR		15 LBS.
		33808	TERMOSTATOS	180°			38158	SENSOR MICRO-V		SERPENTIN
V-8, 5.3 L	2009	K040355SF	A.A. STRECH FIT		V-8, 5.3 L	2006	92092	EDH		PRESION HYDROBOOSTER /
		91030	HERRAMIENTA INST. STRECH F				22437	MANG. INF.		
		22437	MANGUERA INF.				22436	MANG. SUP.		
		23184	MANGUERA SUP.				38009	POLEA		SERPENTIN
		36299	POLEA				38001	POLEA		SERPENTIN
		38009	POLEA DEL TENSOR	SERPENTIN			K060930	SERPENTIN		C/AA
		K060935	SERPENTIN				K040378	SERPENTIN		
		31103	TAPON DE ACEITE				31103	TAPON DE ACEITE		
		31843	TAPON DE GASOLINA				31843	TAPON DE GASOLINA		SIN LLAVE REGULAR
		31844	TAPON DE GASOLINA	CON LLAVE			31532	TAPON DE RADIADOR		(15 lbs) Sin palanca
		31532	TAPONES DE RADIADOR	15 LBS.			38159	SENSOR MICRO-V		A.A.
		39083	SENSOR	SERPENTIN			38158	SENSOR MICRO-V		SERPENTIN
		33808	TERMOSTATOS	180°			33963	TERMOSTATOS		186°
V-8, 6.0 L	2009	K040355SF	A.A. STRECH FIT		V-8, 6.0 L	2006	K040378	A.A.		
		91030	HERRAMIENTA INST. STRECH F				22554	MANGUERA CALEFACCION		CALEFACTOR AL TERMOSTA/
		22437	MANGUERA INF.				22437	MANGUERA INF.		
		23184	MANGUERA SUP.				22436	MANGUERA SUP.		
		36299	POLEA				38001	POLEA		SERPENTIN
		38009	POLEA DEL TENSOR	SERPENTIN			38009	POLEA		SERPENTIN
		K060935	SERPENTIN				K060930	SERPENTIN		C/ALT. 145 A.
		31103	TAPON DE ACEITE				K060923	SERPENTIN		C/ALT. 105 A.
		31843	TAPON DE GASOLINA				31103	TAPON DE ACEITE		
		31844	TAPON DE GASOLINA	CON LLAVE			31843	TAPON DE GASOLINA		SIN LLAVE REGULAR
		31532	TAPONES DE RADIADOR	15 LBS.			31532	TAPON DE RADIADOR		(15 lbs) Sin palanca
		39083	SENSOR	SERPENTIN			38159	SENSOR MICRO-V		A.A.
		33808	TERMOSTATOS	180°			38158	SENSOR MICRO-V		SERPENTIN
V-8, 5.3 L	2008	K040378	A.A.		V-8, 8.1 L	2006	19802	MANGUERA DE PASO		
		22437	MANGUERA INF.				22927	MANGUERA INF.		
		23184	MANGUERA SUP.				22682	MANGUERA SUP.		
		36299	POLEA				38001	POLEA		SERPENTIN
		38009	POLEA DEL TENSOR	SERPENTIN			38009	POLEA		SERPENTIN
		36169	POLEA DEL TENSOR	A.A.						
		K060935	SERPENTIN							
		31103	TAPON DE ACEITE							
		31843	TAPON DE GASOLINA							
		31844	TAPON DE GASOLINA	CON LLAVE						
		31532	TAPONES DE RADIADOR	15 LBS.						
		38159	SENSOR	A.A.						
		38158	SENSOR	SERPENTIN						











    			    				
V-8, 8.1 L	2006	K060950 SERPENTIN K040398 SERPENTIN K060956 SERPENTIN 38259 TENSOR MICRO-V 38260 TENSOR MICRO-V	A.A. SERPENTIN	V-8, 7.4 L	2004	31844 TAPON DE GASOLINA 31532 TAPON DE RADIADOR 31532 TAPONES DE RADIADOR 38158 TENSOR MICRO-V 38159 TENSOR MICRO-V 33963 TERMOSTATOS	CON LLAVE (15 lbs) Sin palanca 15 LBS. SERPENTIN A.A. 186°
V-8, 5.3 L	2005	92092 EDH 22437 MANG. INF. 22436 MANG. SUP. 38009 POLEA 38001 POLEA K060930 SERPENTIN K040378 SERPENTIN 31103 TAPON DE ACEITE 31843 TAPON DE GASOLINA 31532 TAPON DE RADIADOR 38158 TENSOR MICRO-V 38159 TENSOR MICRO-V	V-8, 8.1 L SERPENTIN SERPENTIN C/AA	V-8, 8.1 L	2004	31103 TAPON DE ACEITE 31532 TAPON DE RADIADOR 19802 MANGUERA DE PASO 22927 MANGUERA INF. 22682 MANGUERA SUP. 38001 POLEA 38009 POLEA K060950 SERPENTIN K060956 SERPENTIN K040398 SERPENTIN 31103 TAPON DE ACEITE 31532 TAPON DE RADIADOR 38259 TENSOR MICRO-V 38260 TENSOR MICRO-V	(15 lbs) Sin palanca SERPENTIN SERPENTIN
V-8, 6.0 L	2005	K040378 A.A. 22554 MANGUERA CALEFACCION 22437 MANGUERA INF. 22436 MANGUERA SUP. 38001 POLEA 38009 POLEA K060930 SERPENTIN K060923 SERPENTIN 31103 TAPON DE ACEITE 31843 TAPON DE GASOLINA 31844 TAPON DE GASOLINA 31532 TAPONES DE RADIADOR 38159 TENSOR MICRO-V 38158 TENSOR MICRO-V 33963 TERMOSTATOS	CALEFACTOR AL TERMOSTA SERPENTIN SERPENTIN C/ALT. 145 A. C/ALT. 105 A.	V-8, 5.3 L	2003	K040378 A.A. 22554 CALEF. A TERMOSTATO 30T 3/4" CALEF. AUXILIAR A TUBO-2 92092 EDH 22437 MANGUERA INF. 22436 MANGUERA SUP. 38009 POLEA DEL TENSOR 38001 POLEA LOCA 35B 1/2" RECUPERADOR K060923 SERPENTIN K060930 SERPENTIN 31103 TAPON DE ACEITE 31832 TAPON DE GASOLINA 31532 TAPON DE RADIADOR 38159 TENSOR MICRO-V 38158 TENSOR MICRO-V 33963 TERMOSTATO 18914 TERMOSTATO A CALEF. 30T 3/4" TUBO-1 A CALEF. AUXILIAR 28408 VALV. DE AIRE A MOTOR	(15 lbs) Sin palanca A.A. SERPENTIN PRESION, HYDROBOOSTER
V-8, 8.1 L	2005	19802 MANGUERA DE PASO 22927 MANGUERA INF. 22682 MANGUERA SUP. 38009 POLEA 38001 POLEA K040398 SERPENTIN K060956 SERPENTIN K060950 SERPENTIN 38260 TENSOR MICRO-V 38259 TENSOR MICRO-V	SERPENTIN SERPENTIN	V-8, 5.7 L	2003	31103 TAPON DE ACEITE 31780 TAPON DE GASOLINA 31532 TAPON DE RADIADOR K040378 A.A. 22554 MANGUERA CALEFACCION 22437 MANGUERA INF. 22436 MANGUERA SUP. 38009 POLEA 38001 POLEA K060923 SERPENTIN K060930 SERPENTIN 31103 TAPON DE ACEITE 31103 TAPON DE ACEITE 31844 TAPON DE GASOLINA 31843 TAPON DE GASOLINA 31780 TAPON DE GASOLINA 31532 TAPON DE RADIADOR 31532 TAPONES DE RADIADOR 38159 TENSOR MICRO-V 38158 TENSOR MICRO-V 33963 TERMOSTATOS	SIN LLAVE REGULAR (15 lbs) Sin palanca A.A. Serpentin 186°F
V-8, 5.3 L	2004	22554 CALEF. A TERMOSTATO 35B 3/4" CALEF. AUX. A TUBO 2 92092 EDH 22437 MANGUERA INF. 22436 MANGUERA SUP. 38009 POLEA DEL TENSOR 38001 POLEA LOCA 35B 1/2" RADIADOR A TANQ. DE RECUP. 18126 RADIADOR A VALV. REG. DE AII K060923 SERPENTIN K060930 SERPENTIN K040378 SERPENTIN 31103 TAPON DE ACEITE 31832 TAPON DE GASOLINA 31532 TAPON DE RADIADOR 38159 TENSOR MICRO-V 38158 TENSOR MICRO-V 18914 TERMOSTATO A CALEF. 35B 3/4" TUBO 1 A CALEF. AUXILIAR 28408 VALV. DE AIRE A MOTOR	SERPENTIN A.A. PRESION, HYDROBOOSTER C/ALTERNADOR 105A. C/ALTERNADOR 145A. A.A. SIN LLAVE REGULAR (15 lbs) Sin palanca A.A. SERPENTIN	V-8, 6.0 L	2003	31103 TAPON DE ACEITE 31780 TAPON DE GASOLINA 31532 TAPON DE RADIADOR K040378 A.A. 22554 MANGUERA CALEFACCION 22437 MANGUERA INF. 22436 MANGUERA SUP. 38009 POLEA 38001 POLEA K060923 SERPENTIN K060930 SERPENTIN 31103 TAPON DE ACEITE 31103 TAPON DE ACEITE 31844 TAPON DE GASOLINA 31843 TAPON DE GASOLINA 31780 TAPON DE GASOLINA 31532 TAPON DE RADIADOR 31532 TAPONES DE RADIADOR 38159 TENSOR MICRO-V 38158 TENSOR MICRO-V 33963 TERMOSTATOS	CON LLAVE REGULAR (15 lbs) Sin palanca CALEFACTOR AL TERMOSTA SERPENTIN SERPENTIN C/ALT. 105 A. C/ALT. 145 A.
V-8, 5.7 L	2004	31103 TAPON DE ACEITE 31532 TAPON DE RADIADOR	(15 lbs) Sin palanca	V-8, 7.4 L	2003	31103 TAPON DE ACEITE 31780 TAPON DE GASOLINA 31532 TAPON DE RADIADOR 19802 MANGUERA DE PASO 22927 MANGUERA INF. 22682 MANGUERA SUP. 38009 POLEA 38001 POLEA K060956 SERPENTIN K060950 SERPENTIN K040398 SERPENTIN 31103 TAPON DE ACEITE 31780 TAPON DE GASOLINA	CON LLAVE REGULAR (15 lbs) Sin palanca
V-8, 6.0 L	2004	K040378 A.A. 22554 MANGUERA CALEFACCION 22437 MANGUERA INF. 22436 MANGUERA SUP. 38009 POLEA 38001 POLEA K060930 SERPENTIN K060923 SERPENTIN 31103 TAPON DE ACEITE 31103 TAPON DE ACEITE 31843 TAPON DE GASOLINA	CALEFACTOR AL TERMOSTA SERPENTIN SERPENTIN C/ALT. 145 A. C/ALT. 105 A.	V-8, 8.1 L	2003	31532 TAPON DE RADIADOR	CON LLAVE REGULAR (15 lbs) Sin palanca











V-8, 8.1 L	2003	38260 38259	TENSOR MICRO-V TENSOR MICRO-V	SERPENTIN A.A.		K060930 K060923	SERPENTIN SERPENTIN	C/Alt de 130A. C/Alt de 105A.	
V-8, 5.3 L	2002	K040378 30T 3/4"	CALEF. AUXILIAR A TUBO-2			31103 31780	TAPON DE ACEITE TAPON DE GASOLINA	CON LLAVE REGULAR SIN LLAVE REGULAR	
		92092 18122	EDH MANGUERA DE PASO	PRESION, HYDROBOOSTER		31780 31532	TAPON DE GASOLINA TAPON DE RADIADOR	(15 lbs) Sin palanca	
		22437 22436	MANGUERA INF. MANGUERA SUP.			38159 38158	TENSOR MICRO-V TENSOR MICRO-V		
		38001 38009	POLEA POLEA	SERPENTIN SERPENTIN	V-8, 5.7 L	2001	33910 31780	TERMOSTATO TAPON DE GASOLINA	180°F CON LLAVE REGULAR
		35B 1/2"	RECUPERADOR			31532	TAPON DE RADIADOR	(15 lbs) Sin palanca	
		K060930 K060923	SERPENTIN SERPENTIN	C/Alt 130A. C/Alt 105A.	V-8, 6.0 L	2001	K040378 A.A.		
		31103	TAPON DE ACEITE			80332	EDH	PRESION, C/SIS. CONV C/2W	
		31832	TAPON DE GASOLINA	SIN LLAVE REGULAR		22437	MANGUERA INF.		
		31780	TAPON DE GASOLINA	CON LLAVE REGULAR		22436	MANGUERA SUP.		
		31532	TAPON DE RADIADOR	(15 lbs) Sin palanca		18122	PASO		
		38159	TENSOR MICRO-V	A.A.		38009	POLEA	SERPENTIN	
		38158	TENSOR MICRO-V	Serpentin		38001	POLEA	SERPENTIN	
		33963	TERMOSTATO	186°F		K060930	SERPENTIN	C/Alt de 130A.	
		18914	TERMOSTATO A CALEF.			K060923	SERPENTIN	C/Alt de 105A.	
		30T 3/4"	TUBO-1 A CALEF. AUXILIAR			31103	TAPON DE ACEITE		
		28408	VALV. DE AIRE A MOTOR			31780	TAPON DE GASOLINA	CON LLAVE REGULAR	
V-8, 5.7 L	2002	31103	TAPON DE ACEITE			31832	TAPON DE GASOLINA	SIN LLAVE REGULAR	
		31780	TAPON DE GASOLINA	CON LLAVE REGULAR		31532	TAPON DE RADIADOR	(15 lbs) Sin palanca	
V-8, 6.0 L	2002	K040378 30T 3/4"	A.A. CALEF. AUXILIAR A TUBO-2		V-8, 7.4 L	2001	31780	TAPON DE GASOLINA	
		91984	EDH	PRESION, HYDROBOOSTER	V-8, 8.1 L	2001	31532	TAPON DE RADIADOR	
		18122	MANGUERA DE PASO			38001	POLEA	SERPENTIN	
		22437	MANGUERA INF.			38009	POLEA	SERPENTIN	
		22436	MANGUERA SUP.			31780	TAPON DE GASOLINA	CON LLAVE REGULAR	
		38009	POLEA	SERPENTIN		31532	TAPON DE RADIADOR	(15 lbs) Sin palanca	
		38001	POLEA	SERPENTIN		38259	TENSOR MICRO-V	A.A.	
		35B 1/2"	RECUPERADOR			38260	TENSOR MICRO-V	SERPENTIN	
		K060930 K060923	SERPENTIN SERPENTIN	C/Alt 130A. C/Alt 105A.	V-8, 5.3 L	2000	K040378 A.A.		
		31103	TAPON DE ACEITE			80332	EDH	PRESION, C/SIS. CONV C/2W	
		31780	TAPON DE GASOLINA	CON LLAVE REGULAR		22437	MANGUERA INF.		
		31832	TAPON DE GASOLINA	SIN LLAVE REGULAR		22436	MANGUERA SUP.		
		31532	TAPON DE RADIADOR	(15 lbs) Sin palanca		18122	PASO		
		38159	TENSOR MICRO-V	A.A.		38001	POLEA	SERPENTIN	
		38158	TENSOR MICRO-V	Serpentin		38009	POLEA	SERPENTIN	
		33963	TERMOSTATO	186°F		K060930	SERPENTIN	C/Alt de 130A.	
		18914	TERMOSTATO A CALEF.			K060923	SERPENTIN	C/Alt de 100A., 105A.	
		30T 3/4"	TUBO-1 A CALEF. AUXILIAR			31103	TAPON DE ACEITE		
		28408	VALV. DE AIRE A MOTOR			31832	TAPON DE GASOLINA	SIN LLAVE REGULAR	
V-8, 7.4 L	2002	31103	TAPON DE ACEITE			31780	TAPON DE GASOLINA	CON LLAVE REGULAR	
		31780	TAPON DE GASOLINA	CON LLAVE REGULAR		31532	TAPON DE RADIADOR	(15 lbs) Sin palanca	
V-8, 8.1 L	2002	K040400 30T 5/8"	A.A. CALEF. A MOTOR		V-8, 5.7 L	2000	31780	TAPON DE GASOLINA	
		30T 3/4"	CALEF. AUXILIAR A TUBO-2			K060966	SERPENTIN	C/AA, 100 AMP	
		91984	EDH	PRESION, HYDROBOOSTER		K060875	SERPENTIN	C/AA, 140 AMP	
		38001	POLEA	SERPENTIN		K060870	SERPENTIN	S/AA, 140 AMP	
		38009	POLEA DEL TENSOR			31780	TAPON DE GASOLINA	S/AA, 100 AMP	
		35B 1/2"	RECUPERADOR			31532	TAPON DE RADIADOR	CON LLAVE REGULAR	
		K060956 K060950	SERPENTIN SERPENTIN	C/Alt 130A. C/Alt 105A.	V-8, 6.0 L	2000	K040378 A.A.	(15 lbs) Sin palanca	
		31103	TAPON DE ACEITE			80332	EDH	PRESION, C/SIS. CONV C/2W	
		31099	TAPON DE ACEITE			22437	MANGUERA INF.		
		31780	TAPON DE GASOLINA	CON LLAVE REGULAR		22436	MANGUERA SUP.		
		31832	TAPON DE GASOLINA	SIN LLAVE REGULAR		18122	PASO		
		31532	TAPON DE RADIADOR	(15 lbs) Sin palanca		38001	POLEA	SERPENTIN	
		38260	TENSOR MICRO-V	SERPENTIN		38009	POLEA	SERPENTIN	
		38259	TENSOR MICRO-V	A.A.		K060930	SERPENTIN	C/Alt de 130A.	
		33329	TERMOSTATO	195°F		K060923	SERPENTIN	C/Alt de 100A., 105A.	
		30T 3/4"	TUBO-1 A CALEF. AUXILIAR			31103	TAPON DE ACEITE		
V-8, 5.3 L	2001	K040378 80332	A.A. EDH			31832	TAPON DE GASOLINA	SIN LLAVE REGULAR	
		22437	MANGUERA INF.	PRESION, C/SIS. CONV C/2W		31780	TAPON DE GASOLINA	CON LLAVE REGULAR	
		22436	MANGUERA SUP.			31532	TAPON DE RADIADOR	(15 lbs) Sin palanca	
		18122	PASO			38158	TENSOR MICRO-V		
		38009	POLEA	SERPENTIN	V-8, 7.4 L	2000	38159	TENSOR MICRO-V	
		38001	POLEA	SERPENTIN		33910	TERMOSTATO	180°F	

   				   					
V-8, 7.4 L	2000	33329	TERMOSTATO	195°F		2009	K040355SF	A.A. STRECH FIT	
V-8, 8.1 L	2000	31780	TAPON DE GASOLINA	CON LLAVE REGULAR			91030	HERRAMIENTA INST. STRECH F	
		31532	TAPON DE RADIADOR	(15 lbs) Sin palanca			22437	MANGUERA INF.	
V-8, 5.7 L	1999	361260(802)	EDH	PRESION			23184	MANGUERA SUP.	
		21941	MANGUERA INF.				36299	POLEA	
		21188	MANGUERA INF.	C/AA, C/DH			38009	POLEA DEL TENSOR	SERPENTIN
		CH-141002	MANGUERA SUP.	C/AA, C/DH			K060935	SERPENTIN	
		22358	MANGUERA SUP.				31103	TAPON DE ACEITE	
		19025	PASO				31843	TAPON DE GASOLINA	
		38008	POLEA DEL TENSOR				31844	TAPON DE GASOLINA	CON LLAVE
		38001	POLEA LOCA				31532	TAPONES DE RADIADOR	15 LBS.
		K060966	SERPENTIN	C/AA, 140 AMP			39083	TENSOR	SERPENTIN
		K060960	SERPENTIN	C/AA, 100 AMP			33808	TERMOSTATOS	180°
		K061145	SERPENTIN	C/AA, C/BH, 140 AMP	V-8, 5.3 L	2008	K040378	A.A.	
		K060870	SERPENTIN	S/AA, 100 AMP			22437	MANGUERA INF.	
		K060875	SERPENTIN	S/AA, 140 AMP			23184	MANGUERA SUP.	
		31111	TAPON DE ACEITE				36299	POLEA	
		31832	TAPON DE GASOLINA	SIN LLAVE REGULAR			38009	POLEA DEL TENSOR	SERPENTIN
		31523	TAPON DE RADIADOR	(16 lbs) Sin Palanca			36169	POLEA DEL TENSOR	A.A.
		38103	TENSOR MICRO-V	S/AA			K060935	SERPENTIN	
		33019	TERMOSTATO	195°F			31103	TAPON DE ACEITE	
V-8, 7.4 L	1999	38001	POLEA	LISO			31844	TAPON DE GASOLINA	CON LLAVE
		38008	POLEA	CON CANALES			31843	TAPON DE GASOLINA	
		38103	TENSOR MICRO-V	SERPENTIN			31532	TAPONES DE RADIADOR	15 LBS.
V-8, 5.7 L	1998	361260(802)	EDH	PRESION			38159	TENSOR	A.A.
		19025	MANGUERA DE PASO	C/AA			38158	TENSOR	SERPENTIN
		CH-146572	MANGUERA INF.	C/AA	V-8, 4.8 L	2007	33963	TERMOSTATOS	186°
		22358	MANGUERA SUP.	C/AA			K040378	A.A.	
		38008	POLEA DEL TENSOR				22437	MANGUERA INF.	
		38001	POLEA LOCA				23184	MANGUERA SUP.	
		K060960	SERPENTIN	C/AA, 100 AMP			38001	POLEA	SERPENTIN
		K060966	SERPENTIN	C/AA, 140 AMP			38009	POLEA	SERPENTIN
		K060870	SERPENTIN	S/AA, 100 AMP			36169	POLEA DEL TENSOR	A.A.
		K060875	SERPENTIN	S/AA, 140 AMP			K060935	SERPENTIN	
		31111	TAPON DE ACEITE				31103	TAPON DE ACEITE	
		31832	TAPON DE GASOLINA	SIN LLAVE REGULAR			31844	TAPON DE GASOLINA	CON LLAVE
		31523	TAPON DE RADIADOR	(16 lbs) Sin Palanca			31843	TAPON DE GASOLINA	
		38103	TENSOR MICRO-V	S/AA			31532	TAPONES DE RADIADOR	15 LBS.
		33019	TERMOSTATO	195°F			38158	TENSOR MICRO-V	SERPENTIN
V-8, 7.4 L	1998	38001	POLEA	LISO			38159	TENSOR MICRO-V	A.A.
		38008	POLEA	CON CANALES			33963	TERMOSTATOS	186°
		38103	TENSOR MICRO-V	SERPENTIN	V-8, 5.3 L	2007	92092	EDH	PRESION HYDROBOOSTER /
V-8, 5.7 L	1997	361260(802)	EDH	PRESION			22437	MANG. INF.	
		CH-146572	MANGUERA INF.				22436	MANG. SUP.	
		CH-140441	MANGUERA SUP.				38009	POLEA	
		38008	POLEA DEL TENSOR	S/AA			38001	POLEA	SERPENTIN
		38001	POLEA LOCA				K060930	SERPENTIN	ALT. C/145 AMP
		K060960	SERPENTIN	C/AA, 100 AMP			K060923	SERPENTIN	ALT. C/105 AMP
		K060966	SERPENTIN	C/AA, 140 AMP			K040378	SERPENTIN	C/AA
		K060870	SERPENTIN	S/AA, 100 AMP			31103	TAPON DE ACEITE	
		K060875	SERPENTIN	S/AA, 140 AMP			31843	TAPON DE GASOLINA	SIN LLAVE REGULAR
		31111	TAPON DE ACEITE				31532	TAPON DE RADIADOR	(15 lbs) Sin palanca
		31748	TAPON DE GASOLINA	SIN LLAVE REGULAR			38159	TENSOR MICRO-V	A.A.
		31523	TAPON DE RADIADOR	(16 lbs) Sin Palanca			38158	TENSOR MICRO-V	SERPENTIN
		38103	TENSOR MICRO-V	S/AA	V-8, 4.8 L	2006	K040378	A.A.	
		33019	TERMOSTATO	195°F			22437	MANGUERA INF.	
V-8, 7.4 L	1997	38008	POLEA	CON CANALES			23184	MANGUERA SUP.	
		38001	POLEA	LISO			38001	POLEA	SERPENTIN
		38103	TENSOR MICRO-V	SERPENTIN			38009	POLEA	SERPENTIN
							36169	POLEA DEL TENSOR	A.A.
							K060935	SERPENTIN	
							31103	TAPON DE ACEITE	
							31843	TAPON DE GASOLINA	
							31844	TAPON DE GASOLINA	CON LLAVE
							31532	TAPONES DE RADIADOR	15 LBS.
							38158	TENSOR MICRO-V	SERPENTIN
							38159	TENSOR MICRO-V	A.A.
							33963	TERMOSTATOS	186°
							92092	EDH	PRESION HYDROBOOSTER /
							22437	MANG. INF.	
							22436	MANG. SUP.	
							38009	POLEA	
							38001	POLEA	SERPENTIN
							38009	POLEA	SERPENTIN
							36169	POLEA DEL TENSOR	A.A.
							K060935	SERPENTIN	
							31103	TAPON DE ACEITE	
							31843	TAPON DE GASOLINA	
							31844	TAPON DE GASOLINA	CON LLAVE
							31532	TAPONES DE RADIADOR	15 LBS.
							38158	TENSOR MICRO-V	SERPENTIN
							38159	TENSOR MICRO-V	A.A.
							33963	TERMOSTATOS	186°
							92092	EDH	PRESION HYDROBOOSTER /
							22437	MANG. INF.	
							22436	MANG. SUP.	
							38009	POLEA	SERPENTIN
							38001	POLEA	SERPENTIN
							K060930	SERPENTIN	ALT. C/145 AMP
							K060923	SERPENTIN	ALT. C/105 AMP

**TAHOE**











V-8, 5.3 L	2010	K040355SF	A.A. STRECH FIT			2006	K040378	A.A.	
		91030	HERRAMIENTA INST. STRECH F				22437	MANGUERA INF.	
		22437	MANGUERA INF.				23184	MANGUERA SUP.	
		23184	MANGUERA SUP.				36299	POLEA	
		36299	POLEA				38009	POLEA DEL TENSOR	SERPENTIN
		38009	POLEA DEL TENSOR	SERPENTIN	V-8, 5.3 L		K060935	SERPENTIN	
		K060935	SERPENTIN				31103	TAPON DE ACEITE	
		31103	TAPON DE ACEITE				31843	TAPON DE GASOLINA	
		31843	TAPON DE GASOLINA				31844	TAPON DE GASOLINA	CON LLAVE
		31844	TAPON DE GASOLINA	CON LLAVE			31532	TAPONES DE RADIADOR	15 LBS.
		31532	TAPONES DE RADIADOR	15 LBS.			38158	TENSOR MICRO-V	SERPENTIN
		39083	TENSOR	SERPENTIN			38159	TENSOR MICRO-V	A.A.
		33808	TERMOSTATOS	180°			33963	TERMOSTATOS	186°

   				   					
V-8, 5.3 L	2006	K040378 31103 31843 31532 38159 38158	SERPENTIN TAPON DE ACEITE TAPON DE GASOLINA TAPON DE RADIADOR TENSOR MICRO-V TENSOR MICRO-V	C/A A SIN LLAVE REGULAR (15 lbs) Sin palanca A.A. SERPENTIN			35B 5/16" 35B 5/16" 35B 5/16" 22048 20661 31109 31612 31412 K040365 K040400 K040425	MANGUERA DE CALEF. MANGUERA DE CALEF. MANGUERA DE CALEF. MANGUERA INF. MANGUERA SUP. TAPON DE ACEITE TAPON DE GASOLINA TAPON DE RADIADOR TRANSMISION DE ACCESORIOS TRANSMISION DE ACCESORIOS	TUBO-1 A THROTTLE BODY BOMBA DE AGUA A THROTT TERMOSTATO A MOTOR
<b>TIGRA</b>									
4 CIL, 1.6 L	2000	K060705 K060355 K060605 38200	SERPENTIN SERPENTIN SERPENTIN TENSOR ARBOL DE LEVAS	SIN D.H. CON D.H.	4 CIL, 2.0 L	2003	18463 18429 22269 20940 35B 1/4" 18202 38010 28408 K050609 K050650 35B 1/4"	CALEF. A TUBO-1 CALEF. A TUBO-2 MANGUERA INF. MANGUERA SUP. MOTOR A TUBO-1 MOTOR A TUBO-4 POLEA DEL TENSOR RECUPERADOR SERPENTIN SERPENTIN T A TUBO-5	S/A A C/A A
4 CIL, 1.6 L	1999	K060605 K060355 K060705 38200	SERPENTIN SERPENTIN SERPENTIN TENSOR ARBOL DE LEVAS	CON D.H. SIN D.H.			31109 31612 31412 38156 35B 1/4" K030195 K040425 K040365 28408 K040400 22048 20661 28408 31109 31612 31412 28408 28461 28408 28408 28408 18429 80279 22269 20940 35B 1/4" 18202 38010 28408 K050650 K050609 35B 1/4"	TAPON DE ACEITE TAPON DE GASOLINA TAPON DE RADIADOR TENSOR MICRO-V VALV. REG. DE AIRE A TUBO 3 VENTILADOR A.A. & D.H. ALT., VENTILADOR B.A. A VALVULA REG. DE AIRE D.H. MANGUERA INF. MANGUERA SUP. RECUPERADOR TAPON DE ACEITE TAPON DE GASOLINA TAPON DE RADIADOR TERMOSTATO A MOTOR TUBO-1 A B.A. TUBO-1 A VALV. REG. DE AIRE VALV. DE AIRE A MOTOR VALV. REG. DE AIRE A TUBO 2 CALEF. A TUBO-2 EDH MANGUERA INF. MANGUERA SUP. MOTOR A TUBO-1 MOTOR A TUBO-4 POLEA DEL TENSOR RECUPERADOR SERPENTIN SERPENTIN T A TUBO-5 TAPON DE ACEITE TAPON DE GASOLINA TAPON DE RADIADOR TENSOR MICRO-V TERMOSTATO VALV. REG. DE AIRE A TUBO 3 VENTILADOR A.A. & D.H. ALT., VENTILADOR B.A. A VALVULA REG. DE AIRE CALEF. A MOTOR CALEF. A TUBO-1 D.H. MANGUERA INF. MANGUERA SUP. RECUPERADOR TAPON DE ACEITE TAPON DE GASOLINA TAPON DE RADIADOR TERMOSTATO A MOTOR TUBO-1 A B.A.	SIN LLAVE REGULAR (16 lbs) Sin Palanca D.H. A.A., D.H.
<b>TORNADO</b>									
4 CIL, 1.8 L	2009	T203 CH-140222 CH-140201 K050690 K050715 TMV-14001 TPG-14004	BANDA ARBOL DE LEVAS MANGUERA INF. MANGUERA SUP. SERPENTIN SERPENTIN TENSOR TENSOR	111 D X 17.0 mm SIN A.A. CON A.A.			31109 31612 31412 38156 35B 1/4" K030195 K040425 K040365 28408 K040400 22048 20661 28408 31109 31612 31412 28408 28461 28408 28408 28408 18429 80279 22269 20940 35B 1/4" 18202 38010 28408 K050650 K050609 35B 1/4"	TAPON DE ACEITE TAPON DE GASOLINA TAPON DE RADIADOR TENSOR MICRO-V VALV. REG. DE AIRE A TUBO 3 VENTILADOR A.A. & D.H. ALT., VENTILADOR B.A. A VALVULA REG. DE AIRE D.H. MANGUERA INF. MANGUERA SUP. RECUPERADOR TAPON DE ACEITE TAPON DE GASOLINA TAPON DE RADIADOR TERMOSTATO A MOTOR TUBO-1 A B.A. TUBO-1 A VALV. REG. DE AIRE VALV. DE AIRE A MOTOR VALV. REG. DE AIRE A TUBO 2 CALEF. A TUBO-2 EDH MANGUERA INF. MANGUERA SUP. MOTOR A TUBO-1 MOTOR A TUBO-4 POLEA DEL TENSOR RECUPERADOR SERPENTIN SERPENTIN T A TUBO-5 TAPON DE ACEITE TAPON DE GASOLINA TAPON DE RADIADOR TENSOR MICRO-V TERMOSTATO VALV. REG. DE AIRE A TUBO 3 VENTILADOR A.A. & D.H. ALT., VENTILADOR B.A. A VALVULA REG. DE AIRE CALEF. A MOTOR CALEF. A TUBO-1 D.H. MANGUERA INF. MANGUERA SUP. RECUPERADOR TAPON DE ACEITE TAPON DE GASOLINA TAPON DE RADIADOR TERMOSTATO A MOTOR TUBO-1 A B.A.	SIN LLAVE REGULAR (16 lbs) Sin Palanca S/A A C/A A
4 CIL, 1.8 L	2008	T203 CH-140222 CH-140201 K050690 K050715 TMV-14001 TPG-14004	BANDA ARBOL DE LEVAS MANGUERA INF. MANGUERA SUP. SERPENTIN SERPENTIN TENSOR TENSOR	111 D X 17.0 mm SIN A.A. CON A.A.	V-6, 2.5 L	2003	28408 K040400 22048 20661 28408 31109 31612 31412 28408 28461 28408 28408 28408 18429 80279 22269 20940 35B 1/4" 18202 38010 28408 K050650 K050609 35B 1/4"	MANGUERA INF. MANGUERA SUP. MANG. SUP. SERPENTIN SERPENTIN TENSOR TENSOR	SIN LLAVE REGULAR (16 lbs) Sin Palanca S/A A C/A A
4 CIL, 1.8 L	2007	T203 CH-140222 CH-140201 K050715 K050690 TMV-14001 TPG-14004	BANDA ARBOL DE LEVAS MANG. INF. MANG. SUP. SERPENTIN SERPENTIN TENSOR TENSOR	C/A A S/A A			31109 31612 31412 28408 28461 28408 28408 28408 18429 80279 22269 20940 35B 1/4" 18202 38010 28408 K050650 K050609 35B 1/4"	MANGUERA INF. MANG. SUP. SERPENTIN SERPENTIN TENSOR TENSOR	SIN LLAVE REGULAR (16 lbs) Sin Palanca S/A A C/A A
4 CIL, 1.8 L	2006	T203 CH-140222 CH-140201 K050690 K050715 TMV-14001 TPG-14004	BANDA ARBOL DE LEVAS MANG. INF. MANG. SUP. SERPENTIN SERPENTIN TENSOR TENSOR	S/A A C/A A	4 CIL, 2.0 L	2002	18429 80279 22269 20940 35B 1/4" 18202 38010 28408 K050650 K050609 35B 1/4"	CALEF. A TUBO-2 EDH MANGUERA INF. MANGUERA SUP. MOTOR A TUBO-1 MOTOR A TUBO-4 POLEA DEL TENSOR RECUPERADOR SERPENTIN SERPENTIN T A TUBO-5 TAPON DE ACEITE TAPON DE GASOLINA TAPON DE RADIADOR TENSOR MICRO-V TERMOSTATO VALV. REG. DE AIRE A TUBO 3 VENTILADOR A.A. & D.H. ALT., VENTILADOR B.A. A VALVULA REG. DE AIRE CALEF. A MOTOR CALEF. A TUBO-1 D.H. MANGUERA INF. MANGUERA SUP. RECUPERADOR TAPON DE ACEITE TAPON DE GASOLINA TAPON DE RADIADOR TERMOSTATO A MOTOR TUBO-1 A B.A.	PRESION
4 CIL, 1.8 L	2005	T203 CH-140222 CH-140201 K050690 K050715 TMV-14001 TPG-14004	BANDA ARBOL DE LEVAS MANG. INF. MANG. SUP. SERPENTIN SERPENTIN TENSOR TENSOR	S/A A C/A A			31109 31612 31412 38156 33920 35B 1/4" K030195 K040425 K040365 28408 18011 18422 K040400 22048 20661 28408 31109 31612 31412 28408 28461	MANGUERA INF. MANGUERA SUP. MOTOR A TUBO-1 MOTOR A TUBO-4 POLEA DEL TENSOR RECUPERADOR SERPENTIN SERPENTIN T A TUBO-5 TAPON DE ACEITE TAPON DE GASOLINA TAPON DE RADIADOR TENSOR MICRO-V TERMOSTATO VALV. REG. DE AIRE A TUBO 3 VENTILADOR A.A. & D.H. ALT., VENTILADOR B.A. A VALVULA REG. DE AIRE CALEF. A MOTOR CALEF. A TUBO-1 D.H. MANGUERA INF. MANGUERA SUP. RECUPERADOR TAPON DE ACEITE TAPON DE GASOLINA TAPON DE RADIADOR TERMOSTATO A MOTOR TUBO-1 A B.A.	SIN LLAVE REGULAR (16 lbs) Sin Palanca 180°F S/A A
4 CIL, 1.8 L	2004	T203 CH-140222 CH-140201 K050690 K050715 TMV-14001 TPG-14004	BANDA ARBOL DE LEVAS MANG. INF. MANG. SUP. SERPENTIN SERPENTIN TENSOR TENSOR	S/A A C/A A			28408 18011 18422 K040400 22048 20661 28408 31109 31612 31412 28408 28461	MANGUERA INF. MANGUERA SUP. MOTOR A TUBO-1 MOTOR A TUBO-4 POLEA DEL TENSOR RECUPERADOR TAPON DE ACEITE TAPON DE GASOLINA TAPON DE RADIADOR TERMOSTATO A MOTOR TUBO-1 A B.A.	SIN LLAVE REGULAR (16 lbs) Sin Palanca 180°F S/A A
4 CIL, 1.8 L	2003	T203 CH-140222 CH-140201 K050715 K050690 TMV-14001 TPG-14004	BANDA ARBOL DE LEVAS MANG. INF. MANG. SUP. SERPENTIN SERPENTIN TENSOR TENSOR	C/A A S/A A	V-6, 2.5 L	2002	28408 18011 18422 K040400 22048 20661 28408 31109 31612 31412 28408 28461	MANGUERA INF. MANGUERA SUP. MOTOR A TUBO-1 MOTOR A TUBO-4 POLEA DEL TENSOR RECUPERADOR TAPON DE ACEITE TAPON DE GASOLINA TAPON DE RADIADOR TERMOSTATO A MOTOR TUBO-1 A B.A.	SIN LLAVE REGULAR (16 lbs) Sin Palanca 180°F S/A A
<b>TRACKER</b>									
V-6, 2.5 L	2004	28461 35B 5/16" 35B 5/16" 35B 5/16"	MANG. A TUBO-1 A B.A. MANGUERA DE CALEF. MANGUERA DE CALEF. MANGUERA DE CALEF.	CORTAR A MEDIDA THROTTLE BODY A TUBO-2 THROTTLE BODY A MOTOR RECUPERADOR					SIN LLAVE REGULAR (16 lbs) Sin Palanca

    		    							
V-6, 2.5 L	2002	28408 VALV. DE AIRE A MOTOR				T41065 TENSOR ARBOL DE LEVAS			
		28408 VALV. DE AIRE A MOTOR				33778 TERMOSTATO		180°F	
4 CIL, 2.0 L	2001	28408 VALV. REG. DE AIRE A TUBO 2		4 CIL, 1.6 L	1997	T212 BANDA ARBOL DE LEVAS		{103 D x 25.4 mm}	
		18429 CALEF. A TUBO-2				21354 MANG. SUP.		CORTAR A MEDIDA	
		80279 EDH	PRESION			20157 MANGUERA INF.		CORTAR A MEDIDA	
		22269 MANGUERA INF.				21404 MANGUERA INF.			
		20940 MANGUERA SUP.				K040319 SERPENTIN		S/AA, C/DH	
		38010 POLEA DEL TENSOR				K040372 SERPENTIN		C/AA, C/DH	
		K050609 SERPENTIN	S/AA			K040315 SERPENTIN		ALT., C/AA, S/DH	
		K050650 SERPENTIN	C/AA			K040330 SERPENTIN		C/AA, S/DH	
		31109 TAPON DE ACEITE				31109 TAPON DE ACEITE			
		31612 TAPON DE GASOLINA	SIN LLAVE REGULAR			31612 TAPON DE GASOLINA		SIN LLAVE REGULAR	
		31412 TAPON DE RADIADOR	(16 lbs) Sin Palanca			31412 TAPON DE RADIADOR		(16 lbs) Sin Palanca	
		38156 TENSOR MICRO-V				33778 TERMOSTATO		180°F	
		33920 TERMOSTATO	180°F						
		K030195 VENT							
4 CIL, 1.6 L	2000	K040372 A.A. & D.H.							
		T212 BANDA ARBOL DE LEVAS	{103 D x 25.4 mm}	6 CIL, 4.2 L	2007	92081 EDH		PRESION	
		K040310 D.H.	S/AA			22651 MANG. INF.			
		21532 INF. - TUBO 1 A TUBO 2				22652 MANG. SUP.			
		21591 INF. - TUBO A RADIADOR				38006 POLEA			
		TCK212 KIT DE DISTRIBUCION				38018 POLEA			
		21398 MANGUERA SUP.				36101 POLEA			
		31109 TAPON DE ACEITE				K060915 SERPENTIN		C/ALT 105 A	
		31612 TAPON DE GASOLINA	SIN LLAVE REGULAR			K060905 SERPENTIN		C/ALT DE 130 A	
		31412 TAPON DE RADIADOR	(16 lbs) Sin Palanca			31103 TAPON DE ACEITE			
		T41065 TENSOR ARBOL DE LEVAS	180°F			31843 TAPON DE GASOLINA		SIN LLAVE REGULAR	
		33778 TERMOSTATO				31532 TAPON DE RADIADOR		(15 lbs) Sin palanca	
		K040320 VENT & ALT				38178 TENSOR MICRO-V			
4 CIL, 2.0 L	2000	18429 CALEF. A TUBO-2				33939 TERMOSTATO		195°F	
		22269 MANGUERA INF.		V-8, 5.3 L	2007	71224 EDH		PRESION	
		20940 MANGUERA SUP.				22754 MANG. INF.			
		38010 POLEA DEL TENSOR				22753 MANG. SUP.			
		K050609 SERPENTIN	S/AA			38001 POLEA		SERPENTIN	
		K050650 SERPENTIN	S/AA			38009 POLEA		SERPENTIN	
		38156 TENSOR MICRO-V				K060923 SERPENTIN			
		K030195 VENTILADOR	S/AA			K040365 SERPENTIN		A.A.	
4 CIL, 1.6 L	1999	K040372 A.A. & D.H.				38158 TENSOR MICRO-V		SERPENTIN	
		T212 BANDA ARBOL DE LEVAS	{103 D x 25.4 mm}	6 CIL, 4.2 L	2006	38159 TENSOR MICRO-V		A.A.	
		K040310 D.H.	S/AA			92081 EDH		PRESION	
		80296 EDH	PRES. DESDE LA BOMBA			22651 MANG. INF.			
		21591 INF. - TUBO A RADIADOR				22652 MANG. SUP.			
		TCK212 KIT DE DISTRIBUCION				38018 POLEA			
		21352 MANGUERA INF.				36101 POLEA			
		21398 MANGUERA SUP.				38006 POLEA LOCA			
		31109 TAPON DE ACEITE				K060915 SERPENTIN		C/ALT 150A	
		31612 TAPON DE GASOLINA	SIN LLAVE REGULAR			K060905 SERPENTIN		C/ALT 130A	
		31412 TAPON DE RADIADOR	(16 lbs) Sin Palanca			31103 TAPON DE ACEITE			
		T41065 TENSOR ARBOL DE LEVAS	180°F			31843 TAPON DE GASOLINA		SIN LLAVE REGULAR	
		33778 TERMOSTATO				31532 TAPON DE RADIADOR		(15 lbs) Sin palanca	
		K040320 VENT & ALT				38178 TENSOR MICRO-V			
4 CIL, 2.0 L	1999	18429 CALEF. A TUBO-2				33939 TERMOSTATO		195°F	
		80279 EDH	PRESION, C/RWD	V-8, 5.3 L	2006	71224 EDH		PRESION	
		22269 MANGUERA INF.				22754 MANG. INF.			
		20940 MANGUERA SUP.				22753 MANG. SUP.			
		38010 POLEA DEL TENSOR				38009 POLEA			
		K050609 SERPENTIN	S/AA			38001 POLEA LOCA			
		K050650 SERPENTIN	S/AA			K060923 SERPENTIN			
		31109 TAPON DE ACEITE				K040365 SERPENTIN		A.A.	
		31612 TAPON DE GASOLINA	SIN LLAVE REGULAR			38158 TENSOR MICRO-V		SERPENTIN	
		31412 TAPON DE RADIADOR	(16 lbs) Sin Palanca			38159 TENSOR MICRO-V		A.A.	
		38156 TENSOR MICRO-V		V-8, 6.0 L	2006	38009 POLEA		SERPENTIN	
		33920 TERMOSTATO	180°F			38001 POLEA		SERPENTIN	
		K030195 VENTILADOR	S/AA			K060935 SERPENTIN			
4 CIL, 1.6 L	1998	K040315 ALT.	C/AA, C/DH			38158 TENSOR MICRO-V		SERPENTIN	
		T212 BANDA ARBOL DE LEVAS	{103 D x 25.4 mm}	6 CIL, 4.2 L	2005	38159 TENSOR MICRO-V		A.A.	
		K040319 D.H.	S/AA, C/DH			92081 EDH		PRESION	
		K040372 D.H.	C/AA, C/DH			22651 MANGUERA INF.			
		K040330 D.H.	C/AA, S/DH			22652 MANGUERA SUP.			
		TCK212 KIT DE DISTRIBUCION				38006 POLEA		LOCA	
		21404 MANGUERA INF.				38018 POLEA			
		20157 MANGUERA INF.				36101 POLEA			
		31109 TAPON DE ACEITE				K060915 SERPENTIN			
		31612 TAPON DE GASOLINA	SIN LLAVE REGULAR			K060905 SERPENTIN			
		31412 TAPON DE RADIADOR	(16 lbs) Sin Palanca			31103 TAPON DE ACEITE			

## TRAILBLAZER



    				    				
6 CIL, 4.2 L	2005	31843 31532 38178 33939	TAPON DE GASOLINA TAPON DE RADIADOR SENSOR MICRO-V TERMOSTATO	SIN LLAVE REGULAR (15 lbs) Sin palanca	92081 22651 22652 19700	EDH MANGUERA INF. MANGUERA SUP. MOTOR A CALEF.	PRESION	
V-8, 5.3 L	2005	71206 22754 22753 38009 38001 K060923 K040365 38159 38158	ENSAMBLE DE DIR. HIDR. MANGUERA INF. MANGUERA SUP. POLEA POLEA SERPENTIN SERPENTIN SENSOR MICRO-V SENSOR MICRO-V	195°F RETORNO    LOCA	36101 38018 38006 35B 3/8" K060915 K060905 31103 31636 31782	POLEA POLEA DEL TENSOR POLEA LOCA RECUPERADOR SERPENTIN SERPENTIN TAPON DE ACEITE TAPON DE GASOLINA TAPON DE GASOLINA	C/Alt 150A. C/Alt 130A.	
6 CIL, 4.2 L	2004	18952 19193 19806 35B 5/8" 28500 28500 92081 22651 22652 19700 36101 38018 38006 35B 3/8" K060915 K060905 18453 18856 31103 31636 31782 31532 38178 33939 18797 18846 35B 3/4" 35B 3/4"	CALEF. A "T"; C/CALEF. AUX. CALEF. A TUBO 1 CALEF. A VALVULA CALEF. AUXILIAR A TUBO-3 CONECTOR - "T" A MULTIPLE; CONECTOR - CALEF. A TUBO 1 EDH MANGUERA INF. MANGUERA SUP. MOTOR A CALEF.; POLEA POLEA DEL TENSOR POLEA LOCA RADIADOR A TANQ. DE RECUP. SERPENTIN SERPENTIN T A MOTOR; C/CALEF. AUX. T A MULTIPLE; C/CALEF. AUX. TAPON DE ACEITE TAPON DE GASOLINA TAPON DE GASOLINA TAPON DE RADIADOR TENSOR MICRO-V TERMOSTATO TUBO 1 A MOTOR; TUBO 3 A VALVULA; C/CALEF. A TUBO 4 A MOTOR; C/CALEF. AU; VALVULA A CONECTOR;	S/CALEFACTOR AUX. C/CALEFACTOR AUX.   C/CALEFACTOR AUX. S/CALEFACTOR AUX. PRESION   S/CALEFACTOR AUX.   C/ ALT. 150A. C/ ALT. 130A.   SIN LLAVE REGULAR CON LLAVE REGULAR (15 lbs) Sin palanca   195°F S/CALEFACTOR AUX.   C/CALEFACTOR AUX.	31782 31532 38178 33939 18797	TAPON DE RADIADOR TENSOR MICRO-V TERMOSTATO TUBO-1 A MOTOR	SIN LLAVE REGULAR CON LLAVE REGULAR (15 lbs) Sin palanca   195°F	
<b>TRAVERSE</b>								
V-6, 3.6 L	2011	23294 23293 K060938 31103 31844 31843 38397	MANGUERA INF. MANGUERA SUP. SERPENTIN TAPON DE ACEITE TAPON DE GASOLINA TAPON DE GASOLINA TENSOR	S/CALEFACTOR AUX.	23294 23293 K060938 31103 31844 31843 38397	MANGUERA INF. MANGUERA SUP. SERPENTIN TAPON DE ACEITE TAPON DE GASOLINA TAPON DE GASOLINA TENSOR	CON LLAVE	
V-6, 3.6 L	2010	23294 23293 K060938 31103 31843 31844 38397	MANGUERA INF. MANGUERA SUP. SERPENTIN TAPON DE ACEITE TAPON DE GASOLINA TAPON DE GASOLINA TENSOR	C/ ALT. 150A. C/ ALT. 130A.	23294 23293 K060938 31103 31843 31844 38397	MANGUERA INF. MANGUERA SUP. SERPENTIN TAPON DE ACEITE TAPON DE GASOLINA TAPON DE GASOLINA TENSOR	CON LLAVE	
<b>UPLANDER</b>								
6 CIL, 4.2 L	2003	19193 22651 22652 19700 36101 38018 38006 35B 3/8" K060915 K060905 31103 31636 31782 31532 38178 18797	CALEF. A TUBO-1 MANGUERA INF. MANGUERA SUP. MOTOR A CALEF. POLEA POLEA DEL TENSOR POLEA LOCA RECUPERADOR SERPENTIN SERPENTIN TAPON DE ACEITE TAPON DE GASOLINA TAPON DE GASOLINA TAPON DE RADIADOR TENSOR MICRO-V TUBO-1 A MOTOR	C/CALEFACTOR AUX.	19193 22651 22652 19700 36101 38018 38006 35B 3/8" K060915 K060905 31103 31636 31782 31532 38178 18797	MANGUERA DE PASO MANGUERA INF. MANGUERA SUP. POLEA POLEA POLEA SERPENTIN TAPON DE ACEITE TAPON DE GASOLINA TAPON DE GASOLINA TAPONES DE RADIADOR TENSOR TERMOSTATOS MANGUERA DE PASO MANGUERA INF. MANGUERA SUP.	RANURADA LISA INF. LISA SUP.      CON LLAVE  15 LBS.  185°	
V-8, 5.3 L	2003	K040365 30T 5/8" 22754 22753 38009 38001 35B 3/8" K060923 31103 31636 31782 31532 38159 38158 30T 5/8" 35B 3/8" 28408 19193	A.A. CALEF. AUX A TUBO-2 MANGUERA INF. MANGUERA SUP. POLEA DEL TENSOR POLEA LOCA RADIADOR A RECUPERADOR SERPENTIN TAPON DE ACEITE TAPON DE GASOLINA TAPON DE GASOLINA TAPON DE RADIADOR TENSOR MICRO-V TENSOR MICRO-V TUBO-1 A CALEF. AUX TUBO-1 A VALV. REG. DE AIRE VALV. DE AIRE A MOTOR CALEF. A TUBO-1	SIN LLAVE REGULAR CON LLAVE REGULAR (15 lbs) Sin palanca A.A. SERPENTIN	31103 31636 31782 31532 38159 38158 30T 5/8" 35B 3/8" 28408 19193	TAPON DE ACEITE TAPON DE GASOLINA TAPON DE GASOLINA TAPON DE RADIADOR TENSOR MICRO-V TENSOR MICRO-V TUBO-1 A CALEF. AUX TUBO-1 A VALV. REG. DE AIRE VALV. DE AIRE A MOTOR CALEF. A TUBO-1	SIN LLAVE REGULAR CON LLAVE REGULAR (15 lbs) Sin palanca A.A. SERPENTIN	CON LLAVE 15 LBS.  185°  C/AA AUX S/AA  SIN LLAVE REGULAR (16 lbs) Sin Palanca  195°F
6 CIL, 4.2 L	2002	19193	CALEF. A TUBO-1	SIN LLAVE REGULAR CON LLAVE REGULAR (15 lbs) Sin palanca	19193	MANG. DE PASO MANG. INF. MANGUERA SUP.		























V-6, 2.5 L	1997	31085 31734 31615 31748 31778 31523 T41039 33878 33878	TAPON DE ACEITE TAPON DE GASOLINA TAPON DE GASOLINA TAPON DE GASOLINA TAPON DE GASOLINA TAPON DE RADIADOR SENSOR ARBOL DE LEVAS TERMOSTATO TERMOSTATO	CON LLAVE C/CONT. DE EMÍ: SIN LLAVE C/CONT. DE EMIS SIN LLAVE REGULAR CON LLAVE REGULAR (16 lbs) Sin Palanca		TCK295 22420 22421 38040 38042 38020 31118 31836 31838 31518 31528 T41084 33918		KIT DE DISTRIBUCION MANGUERA INF. MANGUERA SUP. POLEA POLEA POLEA LOCA TAPON DE ACEITE TAPON DE GASOLINA TAPON DE GASOLINA TAPON DE RADIADOR TAPON DE RADIADOR TENSOR ARBOL DE LEVAS TERMOSTATO		A.A. ALT. Y D.H. CON LLAVE REGULAR SIN LLAVE REGULAR (16 lbs) Con Palanca (16 lbs) Sin Palanca 180°F

CONCORDE

V-6, 3.5 L	2002	8553 GS 7550 K060529 T295 19710 92070 TCK295 22420 22421 38040 38042 19709 18314 31118 31836 31838 31518 31528 T41084 33918 30T 3/4"	A.A. A.A. ALT., D.H. BANDA ARBOL DE LEVAS CALEF. A TUBO-2 EDH KIT DE DISTRIBUCION MANGUERA INF. MANGUERA SUP. POLEA POLEA TANQUE DE RECUPERACION A TANQUE DE RECUPERACION A TAPON DE ACEITE TAPON DE GASOLINA TAPON DE GASOLINA TAPON DE RADIADOR TAPON DE RADIADOR TENSOR ARBOL DE LEVAS TERMOSTATO TUBO-2 A TUBO-3	PRESSION, CAJA A DIR.  A.A. ALT. Y D.H.  CON LLAVE REGULAR SIN LLAVE REGULAR (16 lbs) Con Palanca (16 lbs) Sin Palanca 180°F	V-6, 2.7 L	1999	K060420 K060620 20618 19712 22418 22419 38043 36100 38043 20333 31118 31748 31778 31734 31615 31518 31528		A.A. ALT & D.H. CALEF. A "T" CALEF. A TUBO-1 MANGUERA INF. MANGUERA SUP. POLEA POLEA POLEA DEL TENSOR T A MOTOR TAPON DE ACEITE TAPON DE GASOLINA TAPON DE GASOLINA TAPON DE GASOLINA TAPON DE GASOLINA TAPON DE RADIADOR TAPON DE RADIADOR		A.A. ALT. Y D.H. A.A. ALT. Y D.H. SIN LLAVE REGULAR CON LLAVE REGULAR CON LLAVE C/CONT. DE EMÍ: SIN LLAVE C/CONT. DE EMIS (16 lbs) Con Palanca (16 lbs) Sin Palanca
V-6, 3.2 L	2001	8553 GS K060529 T295 19708 19710 92070 TCK295 22420 22421 38040 38042 38020 31118 31836 31838 31528 31518 33918 K060420 K060630 20618 19712 92070 22418 22419 38043 36100 38043 20333 31103 31118 31838 31528 31518 33917	A.A. ALT & D.H. BANDA ARBOL DE LEVAS CALEF. A TUBO-1 CALEF. A TUBO-2 EDH KIT DE DISTRIBUCION MANGUERA INF. MANGUERA SUP. POLEA POLEA POLEA TENSOR - ALT Y A.A. TAPON DE ACEITE TAPON DE GASOLINA TAPON DE GASOLINA TAPON DE RADIADOR TAPON DE RADIADOR TERMOSTATO	PRESSION, CAJA A DIR.  A.A. ALT. Y D.H.  CON LLAVE REGULAR SIN LLAVE REGULAR (16 lbs) Sin Palanca (16 lbs) Con Palanca 180°F	V-6, 3.2 L	1999	8553 GS 6555 GS K060529 T295 19708 19710 92070 TCK295 22420 22421 38040 38042 38020 31118 31778 31615 31734 31748 31528 31518 T41084 33918		A.A. A.A. SMPI, SOHC SMPI, SOHC BANDA ARBOL DE LEVAS CALEF. A TUBO-1 CALEF. A TUBO-2 EDH KIT DE DISTRIBUCION MANGUERA INF. MANGUERA SUP. POLEA POLEA POLEA LOCA TAPON DE ACEITE TAPON DE GASOLINA TAPON DE GASOLINA TAPON DE GASOLINA TAPON DE RADIADOR TAPON DE RADIADOR		SMPI, SOHC SMPI, SOHC PRESION, CAJA A DIR.  A.A. ALT. Y D.H. CON LLAVE REGULAR SIN LLAVE C/CONT. DE EMIS CON LLAVE C/CONT. DE EMÍ: SIN LLAVE REGULAR (16 lbs) Sin Palanca (16 lbs) Con Palanca 180°F
V-6, 2.7 L	2000	K060420 K060630 20618 19712 92070 22418 22419 38043 36100 38043 20333 31103 31118 31838 31528 31518 33917	A.A. ALT & D.H. CALEF. A "T" CALEF. A TUBO-1 EDH MANGUERA INF. MANGUERA SUP. POLEA POLEA POLEA DEL TENSOR T A MOTOR TAPON DE ACEITE TAPON DE ACEITE TAPON DE GASOLINA TAPON DE RADIADOR TAPON DE RADIADOR TERMOSTATO	PRESSION, CAJA A DIR.  ALT. Y D.H. A.A.  SIN LLAVE REGULAR (16 lbs) Sin Palanca (16 lbs) Con Palanca 195°F	V-6, 2.7 L	1998	K060420 K060620 92070 22418 22419 38043 36100 31103 31748 31734 31778 31615 31518 31528 33917		A.A. ALT. EDH MANG. INF. MANG. SUP. POLEA POLEA TAPON DE ACEITE TAPON DE GASOLINA TAPON DE GASOLINA TAPON DE GASOLINA TAPON DE RADIADOR TAPON DE RADIADOR		PRESION, CAJA A DIR.  ALT. Y D.H. A.A. SIN LLAVE REGULAR CON LLAVE C/CONT. DE EMÍ: CON LLAVE REGULAR SIN LLAVE C/CONT. DE EMIS (16 lbs) Sin Palanca (16 lbs) Con Palanca 195°F
V-6, 3.2 L	2000	6555 GS 8553 GS K060529 T295 19708 19710 92070	A.A. A.A. ALT. BANDA ARBOL DE LEVAS CALEF. A TUBO-1 CALEF. A TUBO-2 EDH	SMPI, SOHC SMPI, SOHC {201 D x 30.0 mm} PRESION, CAJA A DIR.	V-6, 3.2 L	1998	6555 GS K060529 T295 92070 TCK295 22420 22421 38040		A.A. ALT. EDH KIT DE DISTRIBUCION MANGUERA INF. MANGUERA SUP. POLEA		SMPI, SOHC SMPI, SOHC PRESION, CAJA A DIR.  A.A.

    				    				
V-6, 3.2 L	1998	38042 31118 31734 31748 31615 31778 31528 31518 T41084 33918	POLEA TAPON DE ACEITE TAPON DE GASOLINA TAPON DE GASOLINA TAPON DE GASOLINA TAPON DE GASOLINA TAPON DE RADIADOR TAPON DE RADIADOR TENSOR ARBOL DE LEVAS TERMOSTATO	ALT. Y D.H.  CON LLAVE C/CONT. DE EMI: SIN LLAVE REGULAR V-6, 3.8 L SIN LLAVE C/CONT. DE EMIS CON LLAVE REGULAR (16 lbs) Sin Palanca (16 lbs) Con Palanca  180°F				
V-6, 3.5 L	1997	6543 GS K060525 T255 BDH-6304 92121 TCK255 20850 22002 38042 38040 38020 31118 31615 31748 31778 31734 31518 31528 T41002 33849	A.A. ALT. BANDA ARBOL DE LEVAS BOMBA DE DIR. HIDR. EDH KIT DE DISTRIBUCION MANGUERA INF. MANGUERA SUP. POLEA POLEA POLEA LOCA TAPON DE ACEITE TAPON DE GASOLINA TAPON DE GASOLINA TAPON DE GASOLINA TAPON DE GASOLINA TAPON DE RADIADOR TAPON DE RADIADOR TENSOR ARBOL DE LEVAS TERMOSTATO	V-6, 3.3 L   RETORNO DESDE CAJA DE I V-6, 3.8 L  ALT. Y D.H. A.A.  SIN LLAVE C/CONT. DE EMIS SIN LLAVE REGULAR CON LLAVE REGULAR CON LLAVE C/CONT. DE EMI V-6, 3.8 L (16 lbs) Con Palanca (16 lbs) Sin Palanca  195°F				
		31118 31523 31516 92073 38020 K060988 K060966 31118 31523 31516 38113 92073 22222 22226 22227 368690(918) 92073 38020 K060966 K060988 38113 92073 22222 22226 22227 368690(918) 92073 38020 K060988 K060966 38113	TAPON DE ACEITE TAPON DE RADIADOR TAPON DE RADIADOR EDH POLEA DEL TENSOR SERPENTIN SERPENTIN TAPON DE ACEITE TAPON DE RADIADOR TAPON DE RADIADOR TENSOR MICRO-V EDH MANG. INF. MANG. INF. MANGUERA SUP. EDH EDH POLEA DEL TENSOR SERPENTIN SERPENTIN TENSOR MICRO-V EDH MANG. INF. MANG. INF. MANGUERA SUP. EDH EDH POLEA DEL TENSOR SERPENTIN SERPENTIN TENSOR MICRO-V	(16 lbs) Sin Palanca (16 lbs) Con palanca PRESION  SOHC, SMPI S/AA SOHC, SMPI C/AA  (16 lbs) Sin Palanca (16 lbs) Con palanca  PRESION S/ENFRIADOR DE SERV. PE\$ C/ENFRIADOR DE SERV. PE\$  PRESION PRESION  SOHC, SMPI C/AA SOHC, SMPI S/AA  PRESION PRESION  SOHC, SMPI S/AA SOHC, SMPI C/AA				

**CROSSFIRE**

V-6, 3.2 L	2005	38082 38174	POLEA TENSOR MICRO-V
V-6, 3.2 L	2004	38082 38174	POLEA TENSOR MICRO-V

**NEW YORKER**









V-6, 3.5 L	1998	BDH-6304	BOMBA DE DIR. HIDR.	
V-6, 3.5 L	1997	6555GS BDH-6304 366510(918) 20850 22002 K060525	BANDA A.A., BOMBA DE DIR. HIDR. EDH MANG. INF. MANG. SUP. SERPENTIN	PRESION     ALT.

**GRAND VOYAGER**

V-6, 3.3 L	2000	T139 92073 TCK139 22222 22226 22227 38034 38042 K060966 31085 31118 31836 31838 31516 31523 38113 33849	BANDA ARBOL DE LEVAS EDH KIT DE DISTRIBUCION MANG. INF. MANG. INF. MANGUERA SUP. POLEA POLEA SERPENTIN TAPON DE ACEITE TAPON DE ACEITE TAPON DE GASOLINA TAPON DE GASOLINA TAPON DE RADIADOR TAPON DE RADIADOR TENSOR MICRO-V TERMOSTATO	PRESION  S/ENFRIADOR DE SERV. PE\$ C/ENFRIADOR DE SERV. PE\$ V-6, 4.0 L  A.A. SOPORTE LISO C/AA, C/DH  V-6, 4.0 L  CON LLAVE REGULAR SIN LLAVE REGULAR (16 lbs) Con palanca (16 lbs) Sin Palanca V-6, 3.5 L LISO 195°F C/Calef. Auxiliar PRESION CORTAR A MEDIDA CORTAR A MEDIDA C/ENFRIADOR DE SERV. PE\$ C/ENFRIADOR DE SERV. PE\$  S/AA C/AA V-6, 3.8 L  SIN LLAVE REGULAR CON LLAVE REGULAR (16 lbs) Sin Palanca (16 lbs) Con palanca 195°F V-6, 3.5 L	
V-6, 3.8 L	2000	19025 92073 18873 18948 22226 22222 22227 K060988 K060966 31118 31838 31836 31523 31516 33849	CALEF. A TUBO-2 EDH MANG. CALEF. A TUBO-1 MANG. CALEF. A MOTOR MANG. INF. MANG. INF. MANGUERA SUP. SERPENTIN SERPENTIN TAPON DE ACEITE TAPON DE GASOLINA TAPON DE GASOLINA TAPON DE RADIADOR TAPON DE RADIADOR TERMOSTATO		
V-6, 3.3 L	1999	92073 22222 22226 22227	EDH MANG. INF. MANG. INF. MANGUERA SUP.	PRESION S/ENFRIADOR DE SERV. PE\$ C/ENFRIADOR DE SERV. PE\$	

**PACIFICA**

	2008	T295 K060695 31535 38417 33849	BANDA ARBOL DE LEVAS SERPENTIN TAPON DE RADIADOR TENSOR MICRO-V TERMOSTATO	(18 lbs) Con Palanca   195°F
	2007	T295 K060695 31535 38417 33849	BANDA ARBOL DE LEVAS SERPENTIN TAPON DE RADIADOR TENSOR MICRO-V TERMOSTATO	(18 lbs) Con Palanca   195°F
	2006	T295 92110 19087 22852 22851 K060935 31103 31838 31535 38323 33952 92110 22852 22851 K060763 31838 33952	BANDA ARBOL DE LEVAS EDH MANG. DE PASO MANG. INF. MANG. SUP. SERPENTIN TAPON DE ACEITE TAPON DE GASOLINA TAPON DE RADIADOR TENSOR MICRO-V TERMOSTATO EDH MANG. INF. MANG. SUP. SERPENTIN TAPON DE GASOLINA TERMOSTATO	PRESION           PRESION           PRESION           PRESION
	2005	T295 22852 22851 K060935 31103	BANDA ARBOL DE LEVAS MANGUERA INF. MANGUERA SUP. SERPENTIN TAPON DE ACEITE	(18 lbs) Con Palanca    195°F

									
V-6, 3.5 L	2005	31838 31535 38323 33952	TAPON DE GASOLINA TAPON DE RADIADOR TENSOR MICRO-V TERMOSTATO	SIN LLAVE REGULAR (18 lbs) Con Palanca			31838 31525 38176 33849	TAPON DE GASOLINA TAPON DE RADIADOR TENSOR MICRO-V TERMOSTATO	SIN LLAVE REGULAR (18 lbs) Sin Palanca
V-6, 3.8 L	2005	22852 22851 K060763 33952	MANGUERA INF. MANGUERA SUP. SERPENTIN TERMOSTATO	195°F	4 CIL, 2.4 L	2006	T265 92091 22627 21707 22853	BANDA ARBOL DE LEVAS EDH MANG. INF. MANG. SUP. MANG. SUP.	PRESION S/TURBO C/TURBO
V-6, 3.5 L	2004	T295 K060935 K060938 31103 31838 31525 38323	BANDA ARBOL DE LEVAS SERPENTIN SERPENTIN TAPON DE ACEITE TAPON DE GASOLINA TAPON DE RADIADOR TENSOR MICRO-V	195°F 11 OCT, 2003 y DESPUES 10 OCT, 2003 y ANTES SIN LLAVE REGULAR (18 lbs) Sin Palanca			K040345 K040510 K040551 31103 31838 31525 38176 33849	SERPENTIN SERPENTIN SERPENTIN TAPON DE ACEITE TAPON DE GASOLINA TAPON DE RADIADOR TENSOR MICRO-V TERMOSTATO	ALT. D.H. S/AA D.H. C/AA SIN LLAVE REGULAR (18 lbs) Sin Palanca 195°F

**PT CRUISER**

4 CIL, 2.4 L	2010	T265 22627 21707 22853 T42121 36156 K040345 K040551 K040510 31118 31836 31838 T43008 38176 T43131 33849	BANDA ARBOL DE LEVAS MANGUERA INF. MANGUERA SUP. MANGUERA SUP. POLEA DE DISTRIBUCION POLEA DEL TENSOR SERPENTIN SERPENTIN SERPENTIN TAPON DE ACEITE TAPON DE GASOLINA TAPON DE GASOLINA TENSOR TENSOR TENSOR TERMOSTATOS	146 D X 28 mm SIN TURBO CON TURBO ALT. CON A.A. SIN A.A. CON LLAVE SIN SOPORTE CON SOPORTE 195°	4 CIL, 2.4 L	2005	T265 92091 22627 21707 22814 T42121 K040551 K040345 K040510 31103 31838 31525 T43008 38176 33849	BANDA ARBOL DE LEVAS EDH MANGUERA INF. MANGUERA SUP. MANGUERA SUP. POLEA BANDA DE TIEMPO SERPENTIN SERPENTIN SERPENTIN TAPON DE ACEITE TAPON DE GASOLINA TAPON DE RADIADOR TENSOR ARBOL DE LEVAS TENSOR MICRO-V TERMOSTATO	PRESION SIN LLAVE REGULAR (18 lbs) Sin Palanca A.A. Y D.H. 195°F
4 CIL, 2.4 L	2009	T265 22627 22853 21707 T42121 36156 K040345 K040510 K040551 31118 31838 31836 T43008 T43131 38176 33849	BANDA ARBOL DE LEVAS MANGUERA INF. MANGUERA SUP. MANGUERA SUP. POLEA DE DISTRIBUCION POLEA DEL TENSOR SERPENTIN SERPENTIN SERPENTIN TAPON DE ACEITE TAPON DE GASOLINA TAPON DE GASOLINA TENSOR TENSOR TENSOR TERMOSTATOS	146 D X 28 mm CON TURBO SIN TURBO ALT. SIN A.A. CON A.A. CON LLAVE SIN SOPORTE CON SOPORTE 195°	4 CIL, 2.4 L	2004	T265 92091 22627 21707 22853 T42121 K040510 K040551 31118 31836 31525 T43008 38176 K040510 K040345 T265 92091 22627 21707 T42121 31118 31838 31528 T43008 38176	BANDA ARBOL DE LEVAS EDH MANGUERA INF. MANGUERA SUP. MANGUERA SUP. POLEA BANDA DE TIEMPO SERPENTIN SERPENTIN TAPON DE ACEITE TAPON DE GASOLINA TAPON DE RADIADOR TENSOR ARBOL DE LEVAS TENSOR MICRO-V A.A., D.H. ALT. BANDA ARBOL DE LEVAS EDH MANGUERA INF. MANGUERA SUP. POLEA BANDA DE TIEMPO TAPON DE ACEITE TAPON DE GASOLINA TAPON DE RADIADOR TENSOR ARBOL DE LEVAS TENSOR MICRO-V	PRESION C/TURBO CON LLAVE REGULAR (18 lbs) Sin Palanca S/AA
4 CIL, 2.4 L	2008	T265 22627 21707 22853 T42121 36156 K040345 K040551 K040510 31118 31836 31838 T43008 T43131 38176 33849	BANDA ARBOL DE LEVAS MANGUERA INF. MANGUERA SUP. MANGUERA SUP. POLEA DE DISTRIBUCION POLEA DEL TENSOR SERPENTIN SERPENTIN SERPENTIN TAPON DE ACEITE TAPON DE GASOLINA TAPON DE GASOLINA TENSOR TENSOR TENSOR TERMOSTATOS	146 D X 28 mm SIN TURBO CON TURBO ALT. CON A.A. SIN A.A. CON LLAVE SIN SOPORTE CON SOPORTE 195°	4 CIL, 2.4 L	2003	T265 92091 22627 21707 T42121 31118 31838 31528 T43008 38176 K040510 K040345 T265 30T 5/8" 30T 5/8" 92090 22627 21707 T42121 31118 31836 31518 T43005 T43008 38176 33849	BANDA ARBOL DE LEVAS EDH MANGUERA INF. MANGUERA SUP. POLEA BANDA DE TIEMPO TAPON DE ACEITE TAPON DE GASOLINA TAPON DE RADIADOR TENSOR ARBOL DE LEVAS TENSOR MICRO-V A.A., D.H. ALT. BANDA ARBOL DE LEVAS CALEF. A TUBO-1 CUELLO DE LLENADO A TUBO-2 EDH MANGUERA INF. MANGUERA SUP. POLEA BANDA DE TIEMPO TAPON DE ACEITE TAPON DE GASOLINA TAPON DE RADIADOR TENSOR ARBOL DE LEVAS TENSOR MICRO-V TERMOSTATO TUBO-1 A B.A. TUBO-2 A CALEF.	PRESION SIN TURBO SIN LLAVE REGULAR (16 lbs) Sin Palanca S/AA PRESION
4 CIL, 2.4 L	2007	T265 92091 22627 21707 22853 K040510 K040551 K040345 31103	BANDA ARBOL DE LEVAS EDH MANG. INF. MANG. SUP. MANG. SUP. SERPENTIN SERPENTIN SERPENTIN TAPON DE ACEITE	PRESION S/TURBO C/TURBO D.H., S/AA D.H., C/AA ALT.		2002	K040560 K040345 T265 30T 5/8" 30T 5/8" 92090 22627 21707 T42121 31118 31836 31518 T43005 T43008 38176 33849 30T 5/8" 30T 5/8"	A.A., D.H. ALT. BANDA ARBOL DE LEVAS CALEF. A TUBO-1 CUELLO DE LLENADO A TUBO-2 EDH MANGUERA INF. MANGUERA SUP. POLEA BANDA DE TIEMPO TAPON DE ACEITE TAPON DE GASOLINA TAPON DE RADIADOR TENSOR ARBOL DE LEVAS TENSOR MICRO-V TERMOSTATO TUBO-1 A B.A. TUBO-2 A CALEF.	CON LLAVE REGULAR (16 lbs) Con Palanca A.A. Y D.H. 195°F







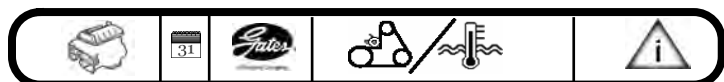





















				<b>TOWN &amp; COUNTRY</b>					
4 CIL, 2.4 L	1999	K040355 K060547 31118 31748 31523 T43005 T43008 33849	SERPENTIN SERPENTIN TAPON DE ACEITE TAPON DE GASOLINA TAPON DE RADIADOR TENSOR ARBOL DE LEVAS TENSOR ARBOL DE LEVAS TERMOSTATO	D.H. ALT. & A.A.  SIN LLAVE REGULAR (16 lbs) Sin Palanca  195°F	V6, 4.0 L	2010	T295 TCK295A 23465 23464 38018 36313 K060695 31836 31838 31523 38417 T43197 33849	BANDA ARBOL DE LEVAS KIT DE DISTRIBUCION MANGUERA INF. MANGUERA SUP. POLEA POLEA DEL TENSOR SERPENTIN TAPON DE GASOLINA TAPON DE GASOLINA TAPONES DE RADIADOR TENSOR TENSOR TERMOSTATOS	
V-6, 2.5 L	1999	K040338 K050586 K060560 T259 K040382 TCK259 22121 22130 20808 21508 38042 T42018 31085 31748 31528 T41039 33878	A.A. ALT. ALT. BANDA ARBOL DE LEVAS D.H. KIT DE DISTRIBUCION MANGUERA INF. MANGUERA INF. MANGUERA SUP. MANGUERA SUP. POLEA POLEA BANDA DE TIEMPO TAPON DE ACEITE TAPON DE GASOLINA TAPON DE RADIADOR TENSOR ARBOL DE LEVAS		V6, 4.0 L	2009	T295 TCK295A 23465 23464 38018 36313 K060695 31836 31838 31523 38417 T43197 33849	BANDA ARBOL DE LEVAS KIT DE DISTRIBUCION MANGUERA INF. MANGUERA SUP. POLEA POLEA DEL TENSOR SERPENTIN TAPON DE GASOLINA TAPON DE GASOLINA TAPONES DE RADIADOR TENSOR TENSOR TERMOSTATOS	CON LLAVE 16 LBS. 195°
4 CIL, 2.4 L	1998	22127 22126 38042 T42121 K060547 K040355 T43008 T43005	MANGUERA INF. MANGUERA SUP. POLEA POLEA BANDA DE TIEMPO SERPENTIN SERPENTIN TENSOR ARBOL DE LEVAS TENSOR ARBOL DE LEVAS	SIN LLAVE REGULAR (16 lbs) Sin Palanca  180°F	V6, 4.0 L	2008	T295 TCK295A 23465 23464 38018 36313 K060695 31836 31838 31523 38417 T43197 33849	BANDA ARBOL DE LEVAS KIT DE DISTRIBUCION MANGUERA INF. MANGUERA SUP. POLEA POLEA DEL TENSOR SERPENTIN TAPON DE GASOLINA TAPON DE GASOLINA TAPONES DE RADIADOR TENSOR TENSOR TERMOSTATOS	CON LLAVE 16 LBS. 195° 201 DIENTES X 30.0 MM
V-6, 2.5 L	1998	K040338 K060560 K050586 T259 K040382 TCK259 22130 22121 20808 21508 38042 T42018 T41039	A.A. ALT. ALT. BANDA ARBOL DE LEVAS D.H. KIT DE DISTRIBUCION MANGUERA INF. MANGUERA INF. MANGUERA SUP. MANGUERA SUP. POLEA POLEA BANDA DE TIEMPO TENSOR ARBOL DE LEVAS		V-6, 3.8 L	2007	22626 22625 38018 38043 K060825 31118 31838 31523 38185 33952 22626 22625 38018 38043 K060825 31118 31838 31523 38185 33952	BANDA ARBOL DE LEVAS KIT DE DISTRIBUCION MANGUERA INF. MANGUERA SUP. POLEA POLEA DEL TENSOR SERPENTIN TAPON DE GASOLINA TAPON DE GASOLINA TAPONES DE RADIADOR TENSOR TENSOR TENSOR MICRO-V TERMOSTATOS MANG. INF. MANG. SUP. POLEA POLEA LOCA SERPENTIN TAPON DE ACEITE TAPON DE GASOLINA TAPON DE RADIADOR TENSOR MICRO-V TERMOSTATO	CON LLAVE 16 LBS. 195°
4 CIL, 2.4 L	1997	22127 22126 38042 T42121 38020 K060547 K040355 T43005 T43008	MANGUERA INF. MANGUERA SUP. POLEA POLEA BANDA DE TIEMPO POLEA LOCA SERPENTIN SERPENTIN TENSOR ARBOL DE LEVAS TENSOR ARBOL DE LEVAS	ALT. & A.A. D.H.	V-6, 3.8 L	2006	22626 22625 38018 38043 K060825 31118 31838 31523 38185 33952 22626 22625 38018 38043 K060825 31118 31838 31523 38185 33952	MANG. INF. MANG. SUP. POLEA POLEA LOCA SERPENTIN TAPON DE ACEITE TAPON DE GASOLINA TAPON DE RADIADOR TENSOR MICRO-V TERMOSTATO MANG. INF. MANG. SUP. POLEA POLEA LOCA SERPENTIN TAPON DE ACEITE TAPON DE GASOLINA TAPON DE RADIADOR TENSOR MICRO-V TERMOSTATO	SIN LLAVE REGULAR (16 lbs) Sin Palanca 195°F
V-6, 2.5 L	1997	K060557 T259 K040381 TCK259 22130 22121 20808 21508 38042 T42018 K040350 K060560 K040384 K050586 31085 31748 31528 T41039 33878	ALT. BANDA ARBOL DE LEVAS D.H. KIT DE DISTRIBUCION MANGUERA INF. MANGUERA INF. MANGUERA SUP. MANGUERA SUP. POLEA POLEA BANDA DE TIEMPO SERPENTIN SERPENTIN SERPENTIN SERPENTIN TAPON DE ACEITE TAPON DE GASOLINA TAPON DE RADIADOR TENSOR ARBOL DE LEVAS TERMOSTATO	A.A. COUPE ALT. & A.A. CONVERTIBLE D.H. CONVERTIBLE ALT. D.H. COUPE  SIN LLAVE REGULAR (16 lbs) Sin Palanca  180°F	V-6, 3.8 L	2005	22626 22625 38018 38043 K060825 31118 31838 31523 38185 33952 22626 22625 38018 38043 K060825 31118 31838 31523 38185 33952	MANG. INF. MANG. SUP. POLEA POLEA LOCA SERPENTIN TAPON DE ACEITE TAPON DE GASOLINA TAPON DE RADIADOR TENSOR MICRO-V TERMOSTATO MANGUERA INF. MANGUERA SUP. POLEA POLEA LOCA SERPENTIN TAPON DE ACEITE TAPON DE GASOLINA TAPON DE RADIADOR TENSOR MICRO-V TERMOSTATO	SIN LLAVE REGULAR (16 lbs) Sin Palanca 195°F
					V-6, 3.8 L	2004	22626 22625	MANGUERA INF. MANGUERA SUP.	195°F

    				    				
V-6, 3.8 L	2004	K060825 31118 31836 31523	SERPENTIN TAPON DE ACEITE TAPON DE GASOLINA TAPON DE RADIADOR	CON LLAVE REGULAR (16 lbs) Con palanca		368700(918); 22222 22226 22227	EDH MANGUERA INF. MANGUERA INF. MANGUERA SUP.	PRESION C/AWD CT, C/DH CT, C/DH CT, C/DH
V-6, 3.3 L	2003	31118 31838 31523	TAPON DE ACEITE TAPON DE GASOLINA TAPON DE RADIADOR	SIN LLAVE REGULAR (16 lbs) Sin Palanca		K060988 K060966	SERPENTIN SERPENTIN	S/AA SOHC, SMPI
V-6, 3.8 L	2003	30T 5/8" 19005 30T 5/8" 22626 22625 38043 K060825 31118 31838 31523	CALEF. A MOTOR CALEF. A VALVULA CALEF. AUXILIAR A TUBO-4 MANGUERA INF. MANGUERA SUP. POLEA LOCA SERPENTIN TAPON DE ACEITE TAPON DE GASOLINA TAPON DE RADIADOR	S/Calefactor Auxiliar C/Calefactor Auxiliar C/Calefactor Auxiliar C/Calefactor Auxiliar C/AA SIN LLAVE REGULAR (16 lbs) Sin Palanca	V-6, 3.3 L	1999 92073 K060966	EDH TAPON DE GASOLINA TAPON DE GASOLINA TAPON DE RADIADOR	CON LLAVE REGULAR SIN LLAVE REGULAR (16 lbs) Sin Palanca
V-6, 3.3 L	2002	30T 5/8" 30T 5/8" 30T 5/8" 30T 5/8" 30T 5/8" 30T 5/8" 30T 5/8" 30T 5/8" 30T 5/8" 92076 31118 31836 31838 31523	TUBO-1 A TUBO-2 TUBO-1 A TUBO-3 TUBO-3 A CALEF. AUXILIAR TUBO-4 A TUBO-5 TUBO-5 A MOTOR VALVULA A TUBO VALVULA A TUBO-1 EDH TAPON DE ACEITE TAPON DE GASOLINA TAPON DE GASOLINA TAPON DE RADIADOR	C/Calefactor Auxiliar C/Calefactor Auxiliar C/Calefactor Auxiliar C/Calefactor Auxiliar C/Calefactor Auxiliar S/Calefactor Auxiliar C/Calefactor Auxiliar PRESION	V-6, 3.8 L	1999 18948 18873 19025	CALEF. A MOTOR CALEF. A TUBO-1 CALEF. A TUBO-2 EDH	S/Calef. Auxiliar C/Calef. Auxiliar C/Calef. Auxiliar
V-6, 3.8 L	2002	22626 22625 38043 K060825 31118 31838 31836 31523 31516	MANGUERA INF. MANGUERA SUP. POLEA LOCA SERPENTIN TAPON DE ACEITE TAPON DE GASOLINA TAPON DE GASOLINA TAPON DE RADIADOR TAPON DE RADIADOR	SIN LLAVE REGULAR (16 lbs) Sin Palanca CON LLAVE REGULAR (16 lbs) Sin Palanca (16 lbs) Con palanca	V-6, 3.8 L	1998 92073 22226 22222 22227	MANGUERA INF. MANGUERA INF. MANGUERA SUP. SERPENTIN TAPON DE ACEITE TAPON DE GASOLINA TAPON DE RADIADOR	195°F 195°F PRESION CT, C/DH CT, C/DH CT, C/DH
V-6, 3.3 L	2001	30T 5/8" 30T 5/8" 30T 5/8" 30T 5/8" 30T 5/8" 30T 5/8" 30T 5/8" 30T 5/8" 30T 5/8" 92076 31118 31836 31838 31523 31516	TUBO-1 A TUBO-2 TUBO-1 A TUBO-3 TUBO-3 A CALEF. AUXILIAR TUBO-4 A TUBO-5 TUBO-5 A MOTOR VALVULA A TUBO VALVULA A TUBO-1 EDH TAPON DE ACEITE TAPON DE GASOLINA TAPON DE GASOLINA TAPON DE RADIADOR TAPON DE RADIADOR	C/Calefactor Auxiliar C/Calefactor Auxiliar C/Calefactor Auxiliar C/Calefactor Auxiliar C/Calefactor Auxiliar S/Calefactor Auxiliar C/Calefactor Auxiliar PRESION	V-6, 3.8 L	1997 92073 22226 22222 22227	EDH MANGUERA INF. MANGUERA INF. MANGUERA SUP. SERPENTIN TAPON DE RADIADOR TAPON DE RADIADOR	PRESION (16 lbs) Sin Palanca (16 lbs) Con palanca (16 lbs) Sin Palanca
V-6, 3.3 L	2001	22626 22625 38043 K060825 31118 31836 31838 31523 31516	MANGUERA INF. MANGUERA SUP. POLEA LOCA SERPENTIN TAPON DE ACEITE TAPON DE GASOLINA TAPON DE GASOLINA TAPON DE RADIADOR TAPON DE RADIADOR	SOHC, SMPI CON LLAVE REGULAR SIN LLAVE REGULAR (16 lbs) Sin Palanca (16 lbs) Con palanca	V-6, 3.3 L	2006 22626 22625 38018 38043	MANG. INF. MANG. SUP. POLEA POLEA SERPENTIN	C/AA SIN LLAVE REGULAR (16 lbs) Sin Palanca
V-6, 3.3 L	2000	92073 K060966 31118 31838 31836 31523 31516	EDH SERPENTIN TAPON DE ACEITE TAPON DE GASOLINA TAPON DE GASOLINA TAPON DE RADIADOR TAPON DE RADIADOR	PRESION SIN LLAVE REGULAR CON LLAVE REGULAR (16 lbs) Sin Palanca (16 lbs) Con palanca	V-6, 3.8 L	2006 22626 22625 38018 38043	EDH SERPENTIN TAPON DE ACEITE TAPON DE GASOLINA TAPON DE RADIADOR TAPON DE RADIADOR	C/AA SIN LLAVE REGULAR (16 lbs) Sin Palanca
V-6, 3.8 L	2000	18948 18873 19025	CALEF. A MOTOR CALEF. A TUBO-1 CALEF. A TUBO-2	S/Calef. Auxiliar C/Calef. Auxiliar C/Calef. Auxiliar	V-6, 3.3 L	2005 K060825 22626	MANG. SUP. SERPENTIN MANGUERA INF.	C/AA

**VOYAGER**

    		    					
V-6, 3.3 L	2005	22625 MANGUERA SUP. 38018 POLEA 38043 POLEA K060825 SERPENTIN 31118 TAPON DE ACEITE 31838 TAPON DE GASOLINA 31523 TAPON DE RADIADOR 38185 TENSOR MICRO-V 33952 TERMOSTATO	SIN LLAVE REGULAR (16 lbs) Sin Palanca  195°F	V-6, 3.3 L	2000	31118 TAPON DE ACEITE 31838 TAPON DE GASOLINA 31836 TAPON DE GASOLINA 31523 TAPON DE RADIADOR 31516 TAPON DE RADIADOR T41048 TENSOR ARBOL DE LEVAS 38122 TENSOR MICRO-V 22226 MANGUERA INF. 22222 MANGUERA INF. 22227 MANGUERA SUP. 38034 POLEA 38042 POLEA 38020 POLEA DEL TENSOR 38001 POLEA LOCA K060966 SERPENTIN 31118 TAPON DE ACEITE 31838 TAPON DE GASOLINA 31836 TAPON DE GASOLINA 31516 TAPON DE RADIADOR 31523 TAPON DE RADIADOR 38113 TENSOR MICRO-V 33849 TERMOSTATO	SIN LLAVE REGULAR CON LLAVE REGULAR (16 lbs) Sin Palanca (16 lbs) Con palanca LISO  A.A. SOPORTE LISO  C/AA, C/DH  SIN LLAVE REGULAR CON LLAVE REGULAR (16 lbs) Con palanca (16 lbs) Sin Palanca  195°F
V-6, 3.8 L	2005	22626 MANGUERA INF. 22625 MANGUERA SUP. K060825 SERPENTIN				18948 CALEF. A MOTOR 18873 CALEF. A TUBO-1 19025 CALEF. A TUBO-2 22226 MANGUERA INF. 22222 MANGUERA INF. 22227 MANGUERA SUP. 38020 POLEA DEL TENSOR K060966 SERPENTIN K060988 SERPENTIN 31118 TAPON DE ACEITE 31516 TAPON DE RADIADOR 31523 TAPON DE RADIADOR 38113 TENSOR MICRO-V 33849 TERMOSTATO	S/CAlef. Auxiliar C/CAlef. Auxiliar C/CAlef. Auxiliar
V-6, 3.3 L	2004	22626 MANGUERA INF. 22625 MANGUERA SUP. 38043 POLEA 38018 POLEA K060825 SERPENTIN 31118 TAPON DE ACEITE 31838 TAPON DE GASOLINA 31523 TAPON DE RADIADOR 38185 TENSOR MICRO-V 33952 TERMOSTATO	SIN LLAVE REGULAR (16 lbs) Sin Palanca  195°F	V-6, 3.3 L	1999	18948 CALEF. A MOTOR 18873 CALEF. A TUBO-1 19025 CALEF. A TUBO-2 22226 MANGUERA INF. 22222 MANGUERA INF. 22227 MANGUERA SUP. 38020 POLEA DEL TENSOR K060966 SERPENTIN K060988 SERPENTIN 31118 TAPON DE ACEITE 31516 TAPON DE RADIADOR 31523 TAPON DE RADIADOR 38113 TENSOR MICRO-V 33849 TERMOSTATO	C/AA, C/DH  SIN LLAVE REGULAR CON LLAVE REGULAR (16 lbs) Con palanca (16 lbs) Sin Palanca  195°F
V-6, 3.8 L	2004	22626 MANGUERA INF. 22625 MANGUERA SUP. K060825 SERPENTIN		V-6, 3.3 L	1999	18948 CALEF. A MOTOR 18873 CALEF. A TUBO-1 19025 CALEF. A TUBO-2 22226 MANGUERA INF. 22222 MANGUERA INF. 22227 MANGUERA SUP. 38020 POLEA DEL TENSOR K060966 SERPENTIN K060988 SERPENTIN 31118 TAPON DE ACEITE 31516 TAPON DE RADIADOR 31523 TAPON DE RADIADOR 38113 TENSOR MICRO-V 33849 TERMOSTATO	S/CAlef. Auxiliar C/CAlef. Auxiliar C/CAlef. Auxiliar
V-6, 3.3 L	2003	38018 POLEA 38043 POLEA 38043 POLEA K060825 SERPENTIN 31118 TAPON DE ACEITE 31836 TAPON DE GASOLINA 31838 TAPON DE GASOLINA 31516 TAPON DE RADIADOR 31523 TAPON DE RADIADOR 38185 TENSOR MICRO-V 33952 TERMOSTATO	C/AA  CON LLAVE REGULAR SIN LLAVE REGULAR (16 lbs) Con palanca (16 lbs) Sin Palanca  195°F	V-6, 3.3 L	1999	18948 CALEF. A MOTOR 18873 CALEF. A TUBO-1 19025 CALEF. A TUBO-2 22226 MANGUERA INF. 22222 MANGUERA INF. 22227 MANGUERA SUP. K060966 SERPENTIN K060988 SERPENTIN 31118 TAPON DE ACEITE 31516 TAPON DE RADIADOR 31523 TAPON DE RADIADOR 38113 TENSOR MICRO-V 33849 TERMOSTATO	C/AA, C/DH S/AA  (16 lbs) Con palanca (16 lbs) Sin Palanca  195°F
V-6, 3.3 L	2002	30T 5/8" CALEF. A MOTOR 19005 CALEF. A VALVULA 30T 5/8" CALEF. AUXILIAR A TUBO-4 22626 MANGUERA INF. 22625 MANGUERA SUP. 38043 POLEA 38018 POLEA 38043 POLEA LOCA K060825 SERPENTIN 31118 TAPON DE ACEITE 31836 TAPON DE GASOLINA 31838 TAPON DE GASOLINA 31523 TAPON DE RADIADOR 31516 TAPON DE RADIADOR 38185 TENSOR MICRO-V 30T 5/8" TUBO-1 A TUBO-2 30T 5/8" TUBO-1 A TUBO-3 30T 5/8" TUBO-3 A CALEF. AUXILIAR 30T 5/8" TUBO-4 A TUBO-5 30T 5/8" TUBO-5 A MOTOR 30T 5/8" VALVULA A TUBO 30T 5/8" VALVULA A TUBO-1	S/CAlefactor Auxiliar C/ & S/ CAlefactor Auxiliar C/CAlefactor Auxiliar  C/AA  CON LLAVE REGULAR SIN LLAVE REGULAR (16 lbs) Sin Palanca (16 lbs) Con palanca  C/CAlefactor Auxiliar C/CAlefactor Auxiliar C/CAlefactor Auxiliar S/CAlefactor Auxiliar C/CAlefactor Auxiliar	V-6, 3.8 L	1999	18948 CALEF. A MOTOR 18873 CALEF. A TUBO-1 19025 CALEF. A TUBO-2 22226 MANGUERA INF. 22227 MANGUERA SUP. K060966 SERPENTIN K060988 SERPENTIN 31118 TAPON DE ACEITE 31523 TAPON DE RADIADOR 31516 TAPON DE RADIADOR 38113 TENSOR MICRO-V 6400 GS A.A. 368700(918) EDH TCK139 KIT DE DISTRIBUCION 22225 MANGUERA INF. 22212 MANGUERA SUP. K060806 SERPENTIN 368700(918) EDH 22226 MANGUERA INF. 22222 MANGUERA INF. 22227 MANGUERA SUP. 38020 POLEA DEL TENSOR K060966 SERPENTIN K060988 SERPENTIN 38113 TENSOR MICRO-V 33849 TERMOSTATO	S/CAlef. Auxiliar C/CAlef. Auxiliar C/CAlef. Auxiliar S/Sist Enf Heavy Duty  C/AA S/AA  (16 lbs) Sin Palanca (16 lbs) Con palanca  C/AA PRESION  C/AA C/AA C/AA PRESION  195°F C/AA PRESION
V-6, 3.0 L	2001	TCK139 KIT DE DISTRIBUCION 31118 TAPON DE ACEITE 31838 TAPON DE GASOLINA 31836 TAPON DE GASOLINA 31516 TAPON DE RADIADOR 31523 TAPON DE RADIADOR	SIN LLAVE REGULAR CON LLAVE REGULAR (16 lbs) Con palanca (16 lbs) Sin Palanca	V-6, 3.0 L	1997	6400 GS A.A. 368700(918) EDH TCK139 KIT DE DISTRIBUCION 22225 MANGUERA INF. 22212 MANGUERA SUP. K060806 SERPENTIN 368700(918) EDH 22226 MANGUERA INF. 22222 MANGUERA INF. 22227 MANGUERA SUP. 38020 POLEA DEL TENSOR K060966 SERPENTIN K060988 SERPENTIN 38113 TENSOR MICRO-V 33849 TERMOSTATO	C/AA, C/DH S/AA  195°F C/AA PRESION
V-6, 3.3 L	2001	38043 POLEA 38018 POLEA 31118 TAPON DE ACEITE 31836 TAPON DE GASOLINA 31838 TAPON DE GASOLINA 31523 TAPON DE RADIADOR 31516 TAPON DE RADIADOR 38185 TENSOR MICRO-V	CON LLAVE REGULAR SIN LLAVE REGULAR (16 lbs) Sin Palanca (16 lbs) Con palanca	V-6, 3.3 L	1997	368700(918) EDH TCK139 KIT DE DISTRIBUCION 22225 MANGUERA INF. 22212 MANGUERA SUP. K060806 SERPENTIN 368700(918) EDH 22222 MANGUERA INF. 22226 MANGUERA INF. 22227 MANGUERA SUP. 38020 POLEA DEL TENSOR K060966 SERPENTIN K060988 SERPENTIN 38113 TENSOR MICRO-V 33849 TERMOSTATO	C/AA C/AA C/AA PRESION  C/AA C/AA C/AA PRESION
V-6, 3.0 L	2000	TCK139 KIT DE DISTRIBUCION 38009 POLEA 38042 POLEA	CON CANALES LISO			22222 MANGUERA INF. 22226 MANGUERA INF. 22227 MANGUERA SUP. 38020 POLEA DEL TENSOR K060966 SERPENTIN 38113 TENSOR MICRO-V	C/AA, C/DH



V-6, 3.3 L | 1997 | 33849 | TERMOSTATO | 195°F



4 CIL, 2.0 L | 2007 | 37018P | POLEA DECOPLADORA | 180°

**DODGE**

**ADVENTURER**

V-6, 3.3 L	2000	22222	MANG. INF.	S/ENFRIADOR DE ACEITE	
		22226	MANG. INF.	C/ENFRIADOR DE ACEITE	4 CIL, 2.4 L
		22227	MANG. SUP.		
		38042	POLEA LOCA	C/POLEA CERCA DEL ALT.	
		K060966	SERPENTIN	C/AA	
		38113	SENSOR MICRO-V		
V-6, 3.3 L	1999	92073	EDH	PRESION	
		22222	MANG. INF.	S/ENFRIADOR DE ACEITE	
		22226	MANG. INF.	C/ENFRIADOR DE ACEITE	
		22227	MANG. SUP.		
		38042	POLEA LOCA	C/POLEA CERCA DEL ALT.	
		K060966	SERPENTIN	C/AA	
		31118	TAPON DE ACEITE		
		38113	SENSOR MICRO-V		
V-6, 3.3 L	1998	22226	MANG. INF.	C/ENFRIADOR DE ACEITE	
		22222	MANG. INF.	S/ENFRIADOR DE ACEITE	
		22227	MANG. SUP.		
		38042	POLEA LOCA	C/POLEA CERCA DEL ALT.	
		K060966	SERPENTIN	C/AA	
		38113	SENSOR MICRO-V		
V-6, 3.3 L	1997	92073	EDH	PRESION	
		22222	MANG. INF.	S/ENFRIADOR DE ACEITE	
		22226	MANG. INF.	C/ENFRIADOR DE ACEITE	4 CIL, 2.4 L
		22227	MANG. SUP.		
		38042	POLEA LOCA	C/POLEA CERCA DEL ALT.	
		K060966	SERPENTIN	C/AA	
		31066	TAPON DE ACEITE		
		31748	TAPON DE GASOLINA	SIN LLAVE REGULAR	
		31523	TAPON DE RADIADOR	(16 lbs) Sin Palanca	
		38113	SENSOR MICRO-V		

**CALIBER**

4 CIL, 2.4 L	2009	37018P	POLEA DECOPLADORA		
		K061005	SERPENTIN		CON A.A. C/CVT
		K060802	SERPENTIN		SIN A.A.
		K061015	SERPENTIN		CON A.A. T.M.
		31118	TAPON DE ACEITE		
		31838	TAPON DE GASOLINA		
		31836	TAPON DE GASOLINA		CON LLAVE
		39053	SENSOR		
		33941	TERMOSTATOS		180°
4 CIL, 2.4 L	2008	37018P	POLEA DECOPLADORA		
		K061015	SERPENTIN		CON A/A; CON TRANSMISION
		K061005	SERPENTIN		CON A.A.; C/CVT
		K060802	SERPENTIN		SIN A.A.
		31118	TAPON DE ACEITE		
		31836	TAPON DE GASOLINA		CON LLAVE
		31838	TAPON DE GASOLINA		
		39053	SENSOR		
		33941	TERMOSTATOS		180°
4 CIL, 2.4 L	2007	37018P	POLEA DECOPLADORA		
		K061015	SERPENTIN		CON A/A; CON TRANSMISION
		K061005	SERPENTIN		CON A.A.; C/CVT
		K060802	SERPENTIN		SIN A.A.
		31118	TAPON DE ACEITE		
		31836	TAPON DE GASOLINA		CON LLAVE
		31838	TAPON DE GASOLINA		
		39053	SENSOR		
		33941	TERMOSTATOS		180°











**AVENGER**

4 CIL, 2.0 L	2009	37018P	POLEA DECOPLADORA		
		K061015	SERPENTIN		
		31118	TAPON DE ACEITE		
		31838	TAPON DE GASOLINA		
		31836	TAPON DE GASOLINA	CON LLAVE	
		31528	TAPONES DE RADIADOR	16 LBS.	
		39053	SENSOR		
		33941	TERMOSTATOS	180°	
4 CIL, 2.4 L	2009	37018P	POLEA DECOPLADORA		
		K061015	SERPENTIN		
		31118	TAPON DE ACEITE		
		31838	TAPON DE GASOLINA	CON LLAVE	
		31836	TAPON DE GASOLINA	16 LBS.	
		31528	TAPONES DE RADIADOR		
		39053	SENSOR		
		33941	TERMOSTATOS	180°	
4 CIL, 2.0 L	2008	37018P	POLEA DECOPLADORA		
		K061015	SERPENTIN		
		31118	TAPON DE ACEITE		
		31838	TAPON DE GASOLINA	CON LLAVE	
		31836	TAPON DE GASOLINA	CON VALVULA	
		31518	TAPONES DE RADIADOR	16 LIBRAS	
		31528	TAPONES DE RADIADOR		
		39053	SENSOR		
		33941	TERMOSTATOS	180°	
4 CIL, 2.4 L	2008	37018P	POLEA DECOPLADORA		
		K061015	SERPENTIN		
		31118	TAPON DE ACEITE		
		31838	TAPON DE GASOLINA	CON LLAVE	
		31836	TAPON DE GASOLINA	CON VALVULA	
		31518	TAPONES DE RADIADOR	16 LIBRAS	
		31528	TAPONES DE RADIADOR		
		39053	SENSOR		
		33941	TERMOSTATOS	180°	

**CARAVAN**

V-6, 3.3 L	2007	19005	MANG. CALEF. A VALVULA	C/CALEFACTOR AUX	
		22626	MANG. INF.		
		22625	MANG. SUP.		
		38018	POLEA		
		38043	POLEA LOCA		
		K060825	SERPENTIN		
		31118	TAPON DE ACEITE		
		31838	TAPON DE GASOLINA	SIN LLAVE REGULAR	
		31523	TAPON DE RADIADOR	(16 lbs) Sin Palanca	
		38185	SENSOR MICRO-V		
V-6, 3.3 L	2006	19005	MANG. CALEF. A VALVULA	C/CALEFACTOR AUX	
		22626	MANG. INF.		
		22625	MANG. SUP.		
		38043	POLEA		
		38018	POLEA		
		K060825	SERPENTIN		
		31118	TAPON DE ACEITE		
		31838	TAPON DE GASOLINA	SIN LLAVE REGULAR	
		31523	TAPON DE RADIADOR	(16 lbs) Sin Palanca	
		38185	SENSOR MICRO-V		
V-6, 3.3 L	2005	19005	MANG. CALEF. A VALVULA	C/CALEFACTOR AUX	
		22626	MANG. INF.		
		22625	MANG. SUP.		
		38043	POLEA		
		38018	POLEA		



    				    				
V-6, 3.3 L	2005	K060825 31118 31838 31523 38185	SERPENTIN TAPON DE ACEITE TAPON DE GASOLINA TAPON DE RADIADOR TENSOR MICRO-V	SIN LLAVE REGULAR (16 lbs) Sin Palanca		38042 K060966 K060988 31836 31516	POLEA LOCA SERPENTIN SERPENTIN TAPON DE GASOLINA TAPON DE RADIADOR	C/POLEA CERCA DEL ALT. C/AA S/AA CON LLAVE REGULAR (16 lbs) Con palanca
V-6, 3.3 L	2004	19005 22626 22625 38018 38043 K060825 31118 31838 31836 31523 31516 38185	MANG. CALEF. A VALVULA MANG. INF. MANG. SUP. POLEA POLEA SERPENTIN TAPON DE ACEITE TAPON DE GASOLINA TAPON DE GASOLINA TAPON DE RADIADOR TAPON DE RADIADOR TENSOR MICRO-V	C/CALEFACTOR AUX	V-6, 3.3 L	1999 38034 38042 K060988 31516 31523 38113 33849	POLEA POLEA SERPENTIN TAPON DE RADIADOR TAPON DE RADIADOR TENSOR MICRO-V TERMOSTATO	(16 lbs) Sin Palanca 195°F A.A. SOPORTE LISO S/AA (16 lbs) Con palanca (16 lbs) Sin Palanca LISO 195°F
V-6, 3.3 L FLEX	2003	19005 22626 22625 38043 K060825 31118 31838 31836 31523 31516	CALEF. A VALVULA MANGUERA INF. MANGUERA SUP. POLEA LOCA SERPENTIN TAPON DE ACEITE TAPON DE GASOLINA TAPON DE GASOLINA TAPON DE RADIADOR TAPON DE RADIADOR	CON & SIN CALEF. AUX.	V-6, 3.3 L	1998 368700(918) 38034 38042 K060988 38113 33849	EDH POLEA POLEA SERPENTIN TENSOR MICRO-V TERMOSTATO	PRESION A.A. SOPORTE LISO S/AA LISO 195°F
4 CIL, 2.4 L	2002	T42121 31118 31836 31523 31516 T43008 T43005	POLEA BANDA DE TIEMPO TAPON DE ACEITE TAPON DE GASOLINA TAPON DE RADIADOR TAPON DE RADIADOR TENSOR ARBOL DE LEVAS TENSOR ARBOL DE LEVAS	CON LLAVE REGULAR (16 lbs) Sin Palanca (16 lbs) Con palanca	4 CIL, 2.4 L	1997 368690(918) 38042 T42121 T43005 T43008 33849	EDH POLEA POLEA BANDA DE TIEMPO TENSOR ARBOL DE LEVAS TENSOR ARBOL DE LEVAS TERMOSTATO	PRESION LISO A.A. SOPORTE S/AA LISO 195°F
V-6, 3.0 L	2002	31118 31836 31516 31523	TAPON DE ACEITE TAPON DE GASOLINA TAPON DE RADIADOR TAPON DE RADIADOR	CON LLAVE REGULAR (16 lbs) Con palanca (16 lbs) Sin Palanca	V-6, 3.5 L	2009 T295 TCK295A 23454 22942 38082 36313 K060825 31299 31838 31836 31525	BANDA ARBOL DE LEVAS KIT DE DISTRIBUCION MANGUERA INF. MANGUERA SUP. POLEA POLEA DEL TENSOR SERPENTIN TAPON DE ACEITE TAPON DE GASOLINA TAPON DE GASOLINA TAPONES DE RADIADOR	
V-6, 3.3 L	2002	92076 38043 38018 31118 31836 31516 31523 38185	EDH POLEA POLEA TAPON DE ACEITE TAPON DE GASOLINA TAPON DE RADIADOR TAPON DE RADIADOR TENSOR MICRO-V	PRESION	V-6, 3.3 L	2002 38018 36313 K060825 31118 31836 31838 31525 38323 34053	TENSOR POLEA POLEA DEL TENSOR SERPENTIN TAPON DE ACEITE TAPON DE GASOLINA TAPONES DE RADIADOR TENSOR TERMOSTATOS	CON LLAVE 18 LBS.
V-6, 3.3 L FLEX	2002	19005 22626 22625 38043 K060825 31118 31838 31836 31516 31523	CALEF. A VALVULA MANGUERA INF. MANGUERA SUP. POLEA LOCA SERPENTIN TAPON DE ACEITE TAPON DE GASOLINA TAPON DE GASOLINA TAPON DE RADIADOR TAPON DE RADIADOR	CON & SIN CALEF. AUX.	V-8, 5.7 L	2009 38018 36313 K060825 31118 31836 31838 31525 38323 34053	TENSOR POLEA POLEA DEL TENSOR SERPENTIN TAPON DE ACEITE TAPON DE GASOLINA TAPONES DE RADIADOR TENSOR TERMOSTATOS	CON LLAVE 18 LBS.
V-6, 3.8 L	2002	92076 31118 31836 31523 31516	EDH TAPON DE ACEITE TAPON DE GASOLINA TAPON DE RADIADOR TAPON DE RADIADOR	PRESION	V-8, 6.1 L	2009 K060825 31118 31838 31836 31525 38323 34053	SERPENTIN TAPON DE ACEITE TAPON DE GASOLINA TAPON DE GASOLINA TAPONES DE RADIADOR TENSOR TERMOSTATOS	203°
V-6, 3.3 L FLEX	2001	19005 22626 22625 38043 K060825 31118 31838 31836 31516 31523	CALEF. A VALVULA MANGUERA INF. MANGUERA SUP. POLEA LOCA SERPENTIN TAPON DE ACEITE TAPON DE GASOLINA TAPON DE GASOLINA TAPON DE RADIADOR TAPON DE RADIADOR	CON & SIN CALEFACTOR AU	V-6, 3.5 L	2008 22943 22942 38082 K060825 31118 31838 31836 31525 38323 33918	MANGUERA SUP. MANGUERA SUP. POLEA SERPENTIN TAPON DE ACEITE TAPON DE GASOLINA TAPON DE GASOLINA TAPON DE RADIADOR TENSOR MICRO-V TERMOSTATO	CON LLAVE 18 LBS. 203°
V-6, 3.3 L	2000	22222 22226 22227 38034	MANG. INF. MANG. INF. MANG. SUP. POLEA	S/ENFRIADOR DE ACEITE C/ENFRIADOR DE ACEITE A.A. SOPORTE				CON LLAVE 18 LIBRAS 180 ° F

**CHARGER**



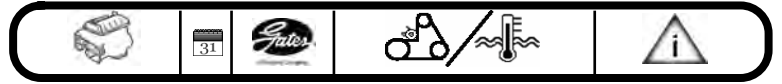





















V-8, 5.7 L	2008	22941 22940 38018 K060825 31118 31836 31838 31525 38323 34053	MANGUERA INF. MANGUERA SUP. POLEA SERPENTIN TAPON DE ACEITE TAPON DE GASOLINA TAPON DE GASOLINA TAPON DE RADIADOR TENSOR MICRO-V TERMOSTATO			33919	TERMOSTATO	195°F	
<b>DURANGO</b>									
V-8, 6.1 L	2008	38018 K060815 31118 31836 31838 31525 38323 34053	POLEA SERPENTIN TAPON DE ACEITE TAPON DE GASOLINA TAPON DE GASOLINA TAPON DE RADIADOR TENSOR MICRO-V TERMOSTATO	CON LLAVE 18 LIBRAS 203°F	V-8, 5.7 L	2008	38018 K060795 31118 31836 31838 31522 38323 33919	POLEA SERPENTIN TAPON DE ACEITE TAPON DE GASOLINA TAPON DE GASOLINA TAPONES DE RADIADOR TENSOR TERMOSTATOS	CON LLAVE 20 LBS. 195°
V-8, 5.7 L	2007	22943 22942 38082 K060825 31118 31836 31838 31525 38323 33918	MANGUERA INF. MANGUERA SUP. POLEA SERPENTIN TAPON DE ACEITE TAPON DE GASOLINA TAPON DE GASOLINA TAPON DE RADIADOR TENSOR MICRO-V TERMOSTATO	180 ° F	V-8, 5.7 L	2007	22897 22896 38058 K071009 31296 31836 31838 31522 38382	MANGUERA INF. MANGUERA SUP. POLEA SERPENTIN TAPON DE ACEITE TAPON DE GASOLINA TAPON DE GASOLINA TAPON DE RADIADOR TENSOR MICRO-V	REQUIERE 2 CON LLAVE 20 LIBRAS
V-8, 5.7 L	2007	22941 22940 38018 K060825 31118 31836 31838 31525 38323 34053	MANGUERA INF. MANGUERA SUP. POLEA SERPENTIN TAPON DE ACEITE TAPON DE GASOLINA TAPON DE GASOLINA TAPON DE RADIADOR TENSOR MICRO-V TERMOSTATO	203°F	V-8, 4.7 L	2006	38009 38001 K060868 31278 31838 31836 31518 38167 33919	POLEA POLEA SERPENTIN TAPON DE ACEITE TAPON DE GASOLINA TAPON DE GASOLINA TAPON DE RADIADOR TENSOR MICRO-V TERMOSTATO	203°F
V-8, 6.1 L	2007	38018 K060815 31118 31836 31838 31525 38323 34053	POLEA SERPENTIN TAPON DE ACEITE TAPON DE GASOLINA TAPON DE GASOLINA TAPON DE RADIADOR TENSOR MICRO-V TERMOSTATO	203°F	V-8, 5.7 L	2006	22897 22896 38058 K071009 31296 31838 31836 31522 38382 34053	MANGUERA INF. MANGUERA SUP. POLEA SERPENTIN TAPON DE ACEITE TAPON DE GASOLINA TAPON DE GASOLINA TAPON DE RADIADOR TENSOR MICRO-V TERMOSTATO	REQUIERE 2 CON LLAVE 20 LIBRAS 203°F











## DAKOTA











V-6, 3.7 L	2009	23041 K060888 31836 31838 31528	MANGUERA SUP. SERPENTIN TAPON DE GASOLINA TAPON DE GASOLINA TAPONES DE RADIADOR	CON LLAVE 16 LBS.	V-6, 3.7 L	2005	38001 38009 K060868 31278 31836 31838 31522 38167	POLEA POLEA SERPENTIN TAPON DE ACEITE TAPON DE GASOLINA TAPON DE GASOLINA TAPON DE RADIADOR TENSOR MICRO-V	CON LLAVE REGULAR SIN LLAVE REGULAR (20 lbs) Sin Palanca
V-6, 3.7 L	2008	23042 23041 38001 38009 K060876 31278 31836 31838 31518 38167 33919	MANGUERA INF. MANGUERA SUP. POLEA POLEA SERPENTIN TAPON DE ACEITE TAPON DE GASOLINA TAPON DE GASOLINA TAPON DE RADIADOR TENSOR MICRO-V TERMOSTATO	195°F	V-8, 4.7 L	2005	22894 38009 38001 K060868 31278 31838 31836 31522	MANGUERA SUP. POLEA POLEA SERPENTIN TAPON DE ACEITE TAPON DE GASOLINA TAPON DE GASOLINA TAPON DE RADIADOR	SIN LLAVE REGULAR CON LLAVE REGULAR (20 lbs) Sin Palanca
V-6, 3.7 L	2007	23042 23041 38009 38001 K060876 31278 31838 31836 31518 38167	MANGUERA INF. MANGUERA SUP. POLEA POLEA SERPENTIN TAPON DE ACEITE TAPON DE GASOLINA TAPON DE GASOLINA TAPON DE RADIADOR TENSOR MICRO-V	16 LIBRAS	V-8, 5.7 L	2005	38167 22897 22896 38058 K071009 31836 31838 31522	TENSOR MICRO-V MANGUERA INF. MANGUERA SUP. POLEA SERPENTIN TAPON DE GASOLINA TAPON DE GASOLINA TAPON DE RADIADOR	CON LLAVE REGULAR SIN LLAVE REGULAR (20 lbs) Sin Palanca
					V-6, 3.7 L	2004	38009 38001	POLEA POLEA	

    				    						
V-6, 3.7 L	2004	31278 31838 31536 38167 33919	TAPON DE ACEITE TAPON DE GASOLINA TAPON DE RADIADOR TENSOR MICRO-V TERMOSTATO	SIN LLAVE REGULAR (20 lbs) Con Palanca				K060878 22545 31278 31836 31838 31522 31536 38167 33919	SERPENTIN SUP. RADIADOR A TAPON TAPON DE ACEITE TAPON DE GASOLINA TAPON DE GASOLINA TAPON DE RADIADOR TAPON DE RADIADOR TENSOR MICRO-V TERMOSTATO	C/AA   CON LLAVE REGULAR SIN LLAVE REGULAR (20 lbs) Sin Palanca (20 lbs) Con Palanca  195°F
V-8, 4.7 L	2004	38009 38001 38042 K060868 31836 31838 31536 31522 38167 38058	POLEA POLEA POLEA DEL TENSOR SERPENTIN TAPON DE GASOLINA TAPON DE GASOLINA TAPON DE RADIADOR TAPON DE RADIADOR TENSOR MICRO-V POLEA	CON LLAVE REGULAR SIN LLAVE REGULAR (20 lbs) Con Palanca (20 lbs) Sin Palanca	V-8, 5.9 L	2001	80306 22551 22038 38033 38016 K070975	EDH MANGUERA INF. PASO POLEA POLEA DEL TENSOR SERPENTIN	195°F PRESION    C/AA	
V-8, 5.7 L	2004	K071009 31838 31836 31522 31536	SERPENTIN TAPON DE GASOLINA TAPON DE GASOLINA TAPON DE RADIADOR TAPON DE RADIADOR	SIN LLAVE REGULAR CON LLAVE REGULAR (20 lbs) Sin Palanca (20 lbs) Con Palanca			22544 22543 31103 31838 31836 31522 31536 38116	SUP. RADIADOR A TAPON SUP. TAPON A MOTOR TAPON DE ACEITE TAPON DE GASOLINA TAPON DE GASOLINA TAPON DE RADIADOR TAPON DE RADIADOR TENSOR MICRO-V	C/AA   SIN LLAVE REGULAR CON LLAVE REGULAR (20 lbs) Sin Palanca (20 lbs) Con Palanca	
V-8, 4.7 L	2003	22550 38009 38001 38042 K060882 22545 31836 31838 31522 31536 38167	MANGUERA INF. POLEA POLEA POLEA DEL TENSOR SERPENTIN SUP. RADIADOR A TAPON TAPON DE GASOLINA TAPON DE GASOLINA TAPON DE RADIADOR TAPON DE RADIADOR TENSOR MICRO-V	RADIADOR A TAPON CON LLAVE REGULAR SIN LLAVE REGULAR (20 lbs) Sin Palanca (20 lbs) Con Palanca	V-8, 4.7 L	2000	38009 K060878 22545 31838 31836 31522 31536 38001 38009 K060878 22545 31838 31836 31522 31536 38116	POLEA SERPENTIN SUP. RADIADOR A TAPON SUP. RADIADOR A TAPON TAPON DE GASOLINA TAPON DE GASOLINA TAPON DE RADIADOR TAPON DE RADIADOR TENSOR MICRO-V MANGUERA INF. POLEA POLEA SERPENTIN SUP. RADIADOR A TAPON TAPON DE GASOLINA TAPON DE GASOLINA TAPON DE RADIADOR TAPON DE RADIADOR TENSOR MICRO-V	(20 lbs) Sin Palanca (20 lbs) Con Palanca    SIN LLAVE REGULAR CON LLAVE REGULAR (20 lbs) Sin Palanca (20 lbs) Con Palanca   PRESION C/4WD	
V-8, 5.9 L	2003	22551 22038 38016 38033 K070975 22544 22543 31118 31838 31836 31536 31522 38116 33009	MANGUERA INF. PASO POLEA DEL TENSOR POLEA LOCA SERPENTIN SUP. RADIADOR A TAPON SUP. TAPON A MOTOR TAPON DE ACEITE TAPON DE GASOLINA TAPON DE GASOLINA TAPON DE RADIADOR TAPON DE RADIADOR TENSOR MICRO-V TERMOSTATO	SIN LLAVE REGULAR CON LLAVE REGULAR (20 lbs) Con Palanca (20 lbs) Sin Palanca	V-8, 5.2 L	2000	80312 22038 38033 38016 K070880 K070975 31118 31838 31836 31536 31522 31525 38116 33509	EDH MANGUERA DE PASO POLEA POLEA SERPENTIN SERPENTIN TAPON DE ACEITE TAPON DE GASOLINA TAPON DE GASOLINA TAPON DE RADIADOR TAPON DE RADIADOR TAPON DE RADIADOR TENSOR MICRO-V TERMOSTATO	S/AA C/AA  SIN LLAVE REGULAR CON LLAVE REGULAR (20 lbs) Con Palanca (20 lbs) Sin Palanca (18 lbs) Sin Palanca  195°F	
V-8, 4.7 L	2002	22550 38001 38009 38042 K060882 22545 31838 31836 31536 31522 38167 33009	MANGUERA INF. POLEA POLEA POLEA DEL TENSOR SERPENTIN SUP. RADIADOR A TAPON TAPON DE GASOLINA TAPON DE GASOLINA TAPON DE RADIADOR TAPON DE RADIADOR TENSOR MICRO-V TERMOSTATO	195°F	V-8, 5.9 L	2000	80306 22038 20226 20370 38033 38016 K070880 K070975 22544 22543 31103 31838 31836 31522 31536 38116	EDH MANGUERA DE PASO MANGUERA SUP. MANGUERA SUP. POLEA POLEA SERPENTIN SERPENTIN SUP. RADIADOR A TAPON SUP. TAPON A MOTOR TAPON DE ACEITE TAPON DE GASOLINA TAPON DE GASOLINA TAPON DE RADIADOR TAPON DE RADIADOR TENSOR MICRO-V	PRESION  C/AA, C/DH C/AA, C/DH C/AA, C/DH   S/AA C/AA	
V-8, 5.9 L	2002	80306 22551 22038 38016 38033 K070975 22544 22543 31118 31103 31836 31838 31522 31536 38116	EDH MANGUERA INF. PASO POLEA DEL TENSOR POLEA LOCA SERPENTIN SUP. RADIADOR A TAPON SUP. TAPON A MOTOR TAPON DE ACEITE TAPON DE ACEITE TAPON DE GASOLINA TAPON DE GASOLINA TAPON DE RADIADOR TAPON DE RADIADOR TENSOR MICRO-V	PRESION	V-6, 3.9 L	1999	80306 22038 22291 22290 38016 38033 K070975 K070880 31118 31615 31734 31748	EDH MANGUERA DE PASO MANGUERA INF. MANGUERA SUP. POLEA POLEA SERPENTIN SERPENTIN SUP. RADIADOR A TAPON SUP. TAPON A MOTOR TAPON DE ACEITE TAPON DE GASOLINA TAPON DE GASOLINA TAPON DE RADIADOR TAPON DE RADIADOR	PRESION C/2WD C/AA C/AA C/AA   C/AA S/AA	
V-8, 4.7 L	2001	352350(803 22550 38001 38009	EDH MANGUERA INF. POLEA POLEA	PRESION C/2WD			31748	TAPON DE GASOLINA TAPON DE GASOLINA TAPON DE GASOLINA	SIN LLAVE C/CONT. DE EMIS CON LLAVE C/CONT. DE EMIS SIN LLAVE REGULAR	











    				    					
V-6, 3.9 L	1999	31778 31536 31522 38116 33509	TAPON DE GASOLINA TAPON DE RADIADOR TAPON DE RADIADOR SENSOR MICRO-V TERMOSTATO	CON LLAVE REGULAR (20 lbs) Con Palanca (20 lbs) Sin Palanca		31536 31528 31523 38116 33509	TAPON DE RADIADOR TAPON DE RADIADOR TAPON DE RADIADOR SENSOR MICRO-V TERMOSTATO	(20 lbs) Con Palanca (16 lbs) Sin Palanca (16 lbs) Sin Palanca 195°F	
V-8, 5.2 L	1999	80306 22038 22287 22288 38033 38016 K070975 K070880 31103 31734 31778 31615 31748 31518 31528 31522 31536 38116 33009	EDH MANGUERA DE PASO MANGUERA INF. MANGUERA SUP. POLEA POLEA SERPENTIN SERPENTIN TAPON DE ACEITE TAPON DE GASOLINA TAPON DE GASOLINA TAPON DE GASOLINA TAPON DE GASOLINA TAPON DE RADIADOR TAPON DE RADIADOR TAPON DE RADIADOR TAPON DE RADIADOR TENSOR MICRO-V TERMOSTATO	195°F PRESION	V-8, 5.9 L	1998	22038 22287 22288 38033 38016 K070880 K070975 31103 31734 31615 31778 31748 31516 31536 31522 31523 38116	MANGUERA DE PASO MANGUERA INF. MANGUERA SUP. POLEA POLEA SERPENTIN SERPENTIN TAPON DE ACEITE TAPON DE GASOLINA TAPON DE GASOLINA TAPON DE GASOLINA TAPON DE GASOLINA TAPON DE RADIADOR TAPON DE RADIADOR TAPON DE RADIADOR TAPON DE RADIADOR TAPON DE RADIADOR TAPON DE RADIADOR TAPON DE RADIADOR TENSOR MICRO-V	S/AA C/AA CON LLAVE C/CONT. DE EMI: SIN LLAVE C/CONT. DE EMIS CON LLAVE REGULAR SIN LLAVE REGULAR (16 lbs) Con Palanca (16 lbs) Sin Palanca (20 lbs) Sin Palanca (20 lbs) Con Palanca
V-8, 5.9 L	1999	80306 22038 22287 22288 38016 38033 K070975 K070880 31118 31103 31734 31778 31615 31748 31522 31518 31528 31536 38116 33509	EDH MANGUERA DE PASO MANGUERA INF. MANGUERA SUP. POLEA POLEA SERPENTIN SERPENTIN TAPON DE ACEITE TAPON DE ACEITE TAPON DE GASOLINA TAPON DE GASOLINA TAPON DE GASOLINA TAPON DE GASOLINA TAPON DE RADIADOR TAPON DE RADIADOR TAPON DE RADIADOR TAPON DE RADIADOR TENSOR MICRO-V TERMOSTATO	195°F PRESION	V-8, 2.7 L	2003	K060420 K060630 20618 19712 22418 22419 38009 36100 38043 20333 31103 31836 31838 31518 31528 19711	A.A. ALT & D.H. CALEF. A "T" CALEF. A TUBO -1 MANGUERA INF. MANGUERA SUP. POLEA POLEA POLEA LOCA T a motor TAPON DE ACEITE TAPON DE GASOLINA TAPON DE GASOLINA TAPON DE RADIADOR TAPON DE RADIADOR TUBO-1 A TANQ. DE RECUP.	A.A. A.A. ALTERNADOR, DIRECCION H CON LLAVE REGULAR SIN LLAVE REGULAR (16 lbs) Con Palanca (16 lbs) Sin Palanca
V-6, 3.9 L	1998	22038 22291 22290 38016 38033 K070975 K070880 31748 31778 31734 31615 31536 31523 31516 31522 38116	MANGUERA DE PASO MANGUERA INF. MANGUERA SUP. POLEA POLEA SERPENTIN SERPENTIN TAPON DE GASOLINA TAPON DE GASOLINA TAPON DE GASOLINA TAPON DE GASOLINA TAPON DE RADIADOR TAPON DE RADIADOR TAPON DE RADIADOR TAPON DE RADIADOR TENSOR MICRO-V	195°F C/AA C/AA C/AA C/AA C/AA S/AA S/AA CON LLAVE REGULAR CON LLAVE REGULAR CON LLAVE C/CONT. DE EMI: SIN LLAVE C/CONT. DE EMIS SIN LLAVE C/CONT. DE EMIS (20 lbs) Con Palanca (16 lbs) Sin Palanca (16 lbs) Sin Palanca (20 lbs) Con Palanca	V-6, 2.7 L	2002	K060420 K060630 20618 19712 22418 22419 38009 36100 38043 38043 38043 20333 31103 31836 31836 31528 19711	A.A. ALT & D.H. CALEF. A "T" CALEF. A TUBO -1 MANGUERA INF. MANGUERA SUP. POLEA POLEA POLEA LOCA POLEA LOCA T A MOTOR TAPON DE ACEITE TAPON DE GASOLINA TAPON DE GASOLINA TAPON DE RADIADOR TAPON DE RADIADOR TUBO-1 A TANQ. DE RECUP.	A.A. A.A. ALTERNADOR, DIRECCION H CON LLAVE REGULAR SIN LLAVE REGULAR (16 lbs) Sin Palanca
V-6, 3.9 L	1998	22038 22291 22290 38016 38033 K070975 K070880 31748 31778 31734 31615 31536 31523 31516 31522 38116	MANGUERA DE PASO MANGUERA INF. MANGUERA SUP. POLEA POLEA SERPENTIN SERPENTIN TAPON DE GASOLINA TAPON DE GASOLINA TAPON DE GASOLINA TAPON DE GASOLINA TAPON DE RADIADOR TAPON DE RADIADOR TAPON DE RADIADOR TAPON DE RADIADOR TENSOR MICRO-V	195°F C/AA C/AA C/AA C/AA C/AA S/AA S/AA CON LLAVE REGULAR CON LLAVE REGULAR CON LLAVE C/CONT. DE EMI: SIN LLAVE C/CONT. DE EMIS SIN LLAVE C/CONT. DE EMIS (20 lbs) Con Palanca (16 lbs) Sin Palanca (16 lbs) Sin Palanca (20 lbs) Sin Palanca	V-6, 3.5 L	2002	8553 GS K060529 T295 19708 19710 TCK295 22420 22421 38040 38042 19709 18314 31118 31838 31518 31528 T41084	A.A. ALT & D.H. BANDA ARBOL DE LEVAS CALEF. A TUBO-1 CALEF. A TUBO-2 KIT DE DISTRIBUCION MANGUERA INF. MANGUERA SUP. POLEA LOCA POLEA LOCA TANQUE DE RECUPERACION A TANQUE DE RECUPERACION A TAPON DE ACEITE TAPON DE GASOLINA TAPON DE RADIADOR TAPON DE RADIADOR TENSOR ARBOL DE LEVAS	A.A. A.A. ALTERNADOR, DIRECCION H SIN LLAVE REGULAR CON LLAVE REGULAR (16 lbs) Sin Palanca
V-8, 5.2 L	1998	360980(718) 22038 22287 22288 38033 38016 K070880 K070975 31118 31615 31734 31778 31748 31516 31522	EDH MANGUERA DE PASO MANGUERA INF. MANGUERA SUP. POLEA POLEA SERPENTIN SERPENTIN TAPON DE ACEITE TAPON DE GASOLINA TAPON DE GASOLINA TAPON DE GASOLINA TAPON DE GASOLINA TAPON DE RADIADOR TAPON DE RADIADOR	PRESION	V-6, 2.7 L	2001	K060420	A.A.	(20 lbs) Sin Palanca

**INTREPID**

    		    								
V-6, 2.7 L	2001	K060630	ALT & D.H.	ALT. Y D.H. A.A.	V-6, 3.5 L	2000	31836	TAPON DE GASOLINA	CON LLAVE REGULAR SIN LLAVE REGULAR (16 lbs) Sin Palanca (16 lbs) Con Palanca	
		20618	CALEF. A "T"					31838		TAPON DE GASOLINA
		19712	CALEF. A TUBO-1					31528		TAPON DE RADIADOR
		22418	MANGUERA INF.					31518		TAPON DE RADIADOR
		22419	MANGUERA SUP.					T41084		TENSOR ARBOL DE LEVAS
		38043	POLEA					8553 GS		A.A.
		36100	POLEA					K060529		ALT & D.H.
		38043	POLEA LOCA					T295		BANDA ARBOL DE LEVAS
		20333	T A MOTOR					19708		CALEF. A TUBO-1
		31103	TAPON DE ACEITE					19710		CALEF. A TUBO-2
		31838	TAPON DE GASOLINA			SIN LLAVE REGULAR		92070		EDH
		31836	TAPON DE GASOLINA			CON LLAVE REGULAR		TCK295		KIT DE DISTRIBUCION
		31528	TAPON DE RADIADOR			(16 lbs) Sin Palanca		22420		MANGUERA INF.
		31518	TAPON DE RADIADOR			(16 lbs) Con Palanca		22421		MANGUERA SUP.
	V-6, 3.2 L	2001	8553 GS			A.A.	PRESION, CAJA A DIR.	V-6, 2.7 L		1999
		K060529	ALT & D.H.			38040			POLEA	
		T295	BANDA ARBOL DE LEVAS			38020			POLEA LOCA	
		19708	CALEF. A TUBO-1			31118			TAPON DE ACEITE	
		19710	CALEF. A TUBO-2			31838			TAPON DE GASOLINA	
		92070	EDH			31836			TAPON DE GASOLINA	
		TCK295	KIT DE DISTRIBUCION			31518			TAPON DE RADIADOR	
		22420	MANGUERA INF.			31528			TAPON DE RADIADOR	
		22421	MANGUERA SUP.			T41084			TENSOR ARBOL DE LEVAS	
		38042	POLEA	ALT.		33918			TERMOSTATO	
		38040	POLEA	A.A.		K060420			A.A.	
		31118	TAPON DE ACEITE			K060620			ALT & D.H.	
		31838	TAPON DE GASOLINA	SIN LLAVE REGULAR		20618			CALEF. A "T"	
		31836	TAPON DE GASOLINA	CON LLAVE REGULAR		19712			CALEF. A TUBO-1	
		31528	TAPON DE RADIADOR	(16 lbs) Sin Palanca		22418			MANGUERA INF.	
	31518	TAPON DE RADIADOR	(16 lbs) Con Palanca		22419	MANGUERA SUP.				
V-6, 3.5 L	2001	8553 GS	A.A.	ALT. A.A.	V-6, 2.7 L	1999	38043	POLEA	ALT. Y D.H. A.A.	
		K060529	ALT & D.H.					36100		POLEA
		T295	BANDA ARBOL DE LEVAS					38043		POLEA DEL TENSOR
		19708	CALEF. A TUBO-1					20333		T A MOTOR
		19710	CALEF. A TUBO-2					31103		TAPON DE ACEITE
		TCK295	KIT DE DISTRIBUCION					31778		TAPON DE GASOLINA
		22420	MANGUERA INF.					31748		TAPON DE GASOLINA
		22421	MANGUERA SUP.					31615		TAPON DE GASOLINA
		38042	POLEA			ALT.		31734		TAPON DE GASOLINA
		38040	POLEA			A.A.		31518		TAPON DE RADIADOR
		31836	TAPON DE GASOLINA			CON LLAVE REGULAR		31528		TAPON DE RADIADOR
		31838	TAPON DE GASOLINA			SIN LLAVE REGULAR		8553 GS		A.A.
		31528	TAPON DE RADIADOR			(16 lbs) Sin Palanca		6555 GS		A.A.
		31518	TAPON DE RADIADOR			(16 lbs) Con Palanca		6555 GS		A.A.
		T41084	TENSOR ARBOL DE LEVAS			(16 lbs) Con Palanca		K060529		ALT.
V-6, 2.7 L	2000	K060420	A.A.	ALT. Y D.H. A.A.	V-6, 3.2 L	1999	T295	BANDA ARBOL DE LEVAS	CON LLAVE REGULAR SIN LLAVE REGULAR SIN LLAVE C/CONT. DE EMIS CON LLAVE C/CONT. DE EMIS (16 lbs) Sin Palanca (16 lbs) Con Palanca	
		K060630	ALT & D.H.					8553 GS		A.A.
		20618	CALEF. A "T"					6555 GS		A.A.
		19712	CALEF. A TUBO-1					6555 GS		A.A.
		22418	MANGUERA INF.					K060529		ALT.
		22419	MANGUERA SUP.					T295		BANDA ARBOL DE LEVAS
		38043	POLEA					19708		CALEF. A TUBO-1
		36100	POLEA			ALT. Y D.H.		19710		CALEF. A TUBO-2
		38043	POLEA DEL TENSOR			A.A.		92070		EDH
		20333	T A MOTOR					TCK295		KIT DE DISTRIBUCION
		31103	TAPON DE ACEITE					22420		MANGUERA INF.
		31838	TAPON DE GASOLINA			SIN LLAVE REGULAR		22421		MANGUERA SUP.
		31836	TAPON DE GASOLINA			CON LLAVE REGULAR		38042		POLEA
		31528	TAPON DE RADIADOR			(16 lbs) Sin Palanca		38040		POLEA
		31518	TAPON DE RADIADOR			(16 lbs) Con Palanca		38020		POLEA LOCA
V-6, 3.2 L	2000	6555 GS	A.A.	CT, C/DH CT, C/DH	V-6, 3.5 L	1999	31118	TAPON DE ACEITE	PRESION, CAJA A DIR.  C/AA, C/DH C/AA, C/DH ALT. A.A.	
		8553 GS	A.A.					31748		TAPON DE GASOLINA
		6555 GS	A.A.					31734		TAPON DE GASOLINA
		K060529	ALT.					31615		TAPON DE GASOLINA
		T295	BANDA ARBOL DE LEVAS					31778		TAPON DE GASOLINA
		19708	CALEF. A TUBO-1					31838		TAPON DE GASOLINA
		19710	CALEF. A TUBO-2					31528		TAPON DE RADIADOR
		TCK295	KIT DE DISTRIBUCION					31518		TAPON DE RADIADOR
		22420	MANGUERA INF.			C/AA, C/DH		T41084		TENSOR ARBOL DE LEVAS
		22421	MANGUERA SUP.			C/AA, C/DH		33918		TERMOSTATO
		38042	POLEA			ALT.		31734		TAPON DE GASOLINA
		38040	POLEA			A.A.		31778		TAPON DE GASOLINA
		38020	POLEA LOCA					31615		TAPON DE GASOLINA
		31118	TAPON DE ACEITE					31748		TAPON DE GASOLINA
								31528		TAPON DE RADIADOR
					31518	TAPON DE RADIADOR				
					K060420	A.A.				
					K060620	ALT.				
					22418	MANG. INF.				
					22419	MANG. SUP.				

    				    					
V-6, 2.7 L	1998	38043 36100 38043 31103 31528 33917	POLEA POLEA POLEA DEL TENSOR TAPON DE ACEITE TAPON DE RADIADOR TERMOSTATO	ALT. Y D.H. A.A.  (16 lbs) Sin Palanca 195°F	T43197 38417 33849	TENSOR TENSOR TERMOSTATOS	195°		
<b>NEON</b>									
V-6, 3.2 L	1998	92070 TCK295 38040 38042 38020 31118 31838 31528 T41084 33918	EDH KIT DE DISTRIBUCION POLEA POLEA POLEA LOCA TAPON DE ACEITE TAPON DE GASOLINA TAPON DE RADIADOR TENSOR ARBOL DE LEVAS TERMOSTATO	PRESION, CAJA A DIR.  A.A. ALT.  SIN LLAVE REGULAR (16 lbs) Sin Palanca  180°F	4 CIL, 2.0 L	2006	T245 92072 22884 22997 36156 K040517 K040335 31118 31838 31525 38277 33849	BANDA ARBOL DE LEVAS EDH MANG. INF. MANG. SUP. POLEA SERPENTIN SERPENTIN TAPON DE ACEITE TAPON DE GASOLINA TAPON DE RADIADOR TENSOR MICRO-V TERMOSTATO	PRESION  CORTAR A MEDIDA  ALT. & D.H. ALT.  SIN LLAVE REGULAR (18 lbs) Sin Palanca  195°F
V-6, 3.5 L	1998	BDH-6304	BOMBA DE DIR. HIDR.						
V-6, 3.3 L	1997	6555 GS K060670 38003 33849	A.A. ALT. POLEA TERMOSTATO	A.A. 195°F	4 CIL, 2.4 L	2006	T265 22884 22883 K040345 K040551	BANDA ARBOL DE LEVAS MANG. INF. MANG. SUP. SERPENTIN SERPENTIN	ALT.
V-6, 3.5 L	1997	6555 GS K060525 T255 BDH-6304 366510(918) TCK255 38042 38040 38004 38020 31118 31748 31528 T41002 33849	A.A. ALT. BANDA ARBOL DE LEVAS BOMBA DE DIR. HIDR. EDH KIT DE DISTRIBUCION POLEA POLEA POLEA LOCA POLEA LOCA TAPON DE ACEITE TAPON DE GASOLINA TAPON DE RADIADOR TENSOR ARBOL DE LEVAS TERMOSTATO	PRESION  ALT. Y D.H. A.A.  SIN LLAVE REGULAR (16 lbs) Sin Palanca  195°F	4 CIL, 2.0 L	2005	T254 92072 22884 20893 K040520 K040335 31118 31838 31836 31525 T43001 33849	BANDA ARBOL DE LEVAS EDH MANGUERA INF. MANGUERA SUP. SERPENTIN SERPENTIN TAPON DE ACEITE TAPON DE GASOLINA TAPON DE GASOLINA TAPON DE RADIADOR TENSOR ARBOL DE LEVAS TERMOSTATO	PRESION  ALT.  SIN LLAVE REGULAR (18 lbs) Sin Palanca 195°F (211 D x 30.0 mm) PRESION
<b>JOURNEY</b>									
4 CIL, 2.4 L	2010	K061015 31118 31836 31838 31525 31535 38323	SERPENTIN TAPON DE ACEITE TAPON DE GASOLINA TAPON DE GASOLINA TAPONES DE RADIADOR TAPONES DE RADIADOR TENSOR	CON LLAVE  18 LBS. 18 LBS. C/VALVULA	4 CIL, 2.4 L	2005	T265 22884 22883 T42121 K040345 K040551	BANDA ARBOL DE LEVAS MANG. INF. MANG. SUP. POLEA BANDA DE TIEMPO SERPENTIN SERPENTIN	ALTERNADOR
V-6, 3.5 L	2010	T295 TCK295A 38018 36313 K060695 31103 31838 31836 31528 31518 38417 T43197 33849	BANDA ARBOL DE LEVAS KIT DE DISTRIBUCION POLEA POLEA DEL TENSOR SERPENTIN TAPON DE ACEITE TAPON DE GASOLINA TAPON DE GASOLINA TAPONES DE RADIADOR TAPONES DE RADIADOR TENSOR TENSOR TERMOSTATOS	4 CIL, 2.0 L  CON LLAVE 16 LBS. 16 LBS. C/VALVULA  195°	4 CIL, 2.0 L	2004	T245 92072 22884 22997 20893 36156 31118 31838	BANDA ARBOL DE LEVAS EDH MANG. INF. MANG. SUP. MANGUERA SUP. POLEA TAPON DE ACEITE TAPON DE GASOLINA	PRESION  SIN LLAVE REGULAR CON LLAVE REGULAR (18 lbs) Sin Palanca  195°F
4 CIL, 2.4 L	2009	K061015 31118 31836 31838 31525 31535 38323	SERPENTIN TAPON DE ACEITE TAPON DE GASOLINA TAPON DE GASOLINA TAPONES DE RADIADOR TAPONES DE RADIADOR TENSOR	CON LLAVE  18 LBS. 18 LBS.	4 CIL, 2.4 L	2004	T265 22884 22883 T42121 K040345 K040551	BANDA ARBOL DE LEVAS MANG. INF. MANG. SUP. POLEA BANDA DE TIEMPO SERPENTIN SERPENTIN	ALT.
V-6, 3.5 L	2009	T295 TCK295A 38018 36313 K060695 31103 31838 31836 31528	BANDA ARBOL DE LEVAS KIT DE DISTRIBUCION POLEA POLEA DEL TENSOR SERPENTIN TAPON DE ACEITE TAPON DE GASOLINA TAPON DE GASOLINA TAPONES DE RADIADOR	201 DIENTES X 30.0 MM  CON LLAVE 16 LBS.	4 CIL, 2.4 L	2004	T265 22884 22883 T42121 K040345 K040551	BANDA ARBOL DE LEVAS MANG. INF. MANG. SUP. POLEA BANDA DE TIEMPO SERPENTIN SERPENTIN	ALT.
V-6, 3.5 L	2009	31103 31838 31836 31528	TAPON DE ACEITE TAPON DE GASOLINA TAPON DE GASOLINA TAPONES DE RADIADOR	CON LLAVE 16 LBS.	4 CIL, 2.4 L	2004	31118 31838 31836 31528	TAPON DE ACEITE TAPON DE GASOLINA TAPON DE GASOLINA TAPON DE RADIADOR	SIN LLAVE REGULAR CON LLAVE REGULAR (18 lbs) Sin Palanca



    				    			
4 CIL., 2.4 L	2004	31518 TAPON DE RADIADOR 31528 TAPON DE RADIADOR T43008 TENSOR ARBOL DE LEVAS 38176 TENSOR MICRO-V 33849 TERMOSTATO	(16 lbs) Con Palanca (16 lbs) Sin Palanca	4 CIL., 2.0 L	1999	T43001 TENSOR ARBOL DE LEVAS 33849 TERMOSTATO K040350 ALT. T246 BANDA ARBOL DE LEVAS T245 BANDA ARBOL DE LEVAS 6480 GS D.H. 6417 GS D.H. 7480 D.H. & A.A. 91949 EDH TCK245 KIT DE DISTRIBUCION TCK246 KIT DE DISTRIBUCION CH-110312 MANGUERA INF. 21763 MANGUERA INF. 22460 MANGUERA INF. 12T172 MANGUERA INF. FLEXIBLE CH-110021 MANGUERA SUP. CH-110301 MANGUERA SUP. 22120 MANGUERA SUP. 22119 MANGUERA SUP. 22118 MANGUERA SUP. 12T150 MANGUERA SUP. FLEXIBLE 31118 TAPON DE ACEITE 31836 TAPON DE GASOLINA 31838 TAPON DE GASOLINA 31528 TAPON DE RADIADOR 31518 TAPON DE RADIADOR T41002 TENSOR ARBOL DE LEVAS T43001 TENSOR ARBOL DE LEVAS 33849 TERMOSTATO	195°F DOHC SOHC C/AA S/AA PRESION C/DOHC SOHC DOHC C/AA C/AA S/AA C/AA S/AA C/AA C/AA SOHC; C/AA DOHC; C/AA SOHC; S/AA C/AA CON LLAVE REGULAR SIN LLAVE REGULAR (16 lbs) Sin Palanca (16 lbs) Con Palanca 195°F C/AA, C/DH
4 CIL., 2.0 L	2003	K040517 A.A., D.H. K040335 ALT. 92072 EDH 31118 TAPON DE ACEITE 31838 TAPON DE GASOLINA 31836 TAPON DE GASOLINA 31528 TAPON DE RADIADOR 31518 TAPON DE RADIADOR T43001 TENSOR ARBOL DE LEVAS 33849 TERMOSTATO	SIN LLAVE REGULAR CON LLAVE REGULAR (16 lbs) Sin Palanca (16 lbs) Con Palanca	4 CIL., 2.0 L	1998	K040350 ALT. T246 BANDA ARBOL DE LEVAS T245 BANDA ARBOL DE LEVAS BDH-5177 BOMBA DE DIR. HIDR. 6413 GS D.H. 6480 GS D.H. 91949 EDH TCK245 KIT DE DISTRIBUCION TCK246 KIT DE DISTRIBUCION CH-110312 MANGUERA INF. 22460 MANGUERA INF. 12T172 MANGUERA INF. FLEXIBLE CH-110301 MANGUERA SUP. CH-110021 MANGUERA SUP. 22120 MANGUERA SUP. 12T150 MANGUERA SUP. FLEXIBLE 31118 TAPON DE ACEITE 31734 TAPON DE GASOLINA 31748 TAPON DE GASOLINA 31778 TAPON DE GASOLINA 31528 TAPON DE RADIADOR T43001 TENSOR ARBOL DE LEVAS T41002 TENSOR ARBOL DE LEVAS 33849 TERMOSTATO	195°F C/AA C/AA PRESION SIN LLAVE REGULAR CON LLAVE REGULAR (16 lbs) Sin Palanca (16 lbs) Con Palanca 195°F C/AA C/AA PRESION C/AA C/AA CON LLAVE C/CONT. DE EMI: SIN LLAVE REGULAR CON LLAVE REGULAR (16 lbs) Sin Palanca 195°F C/AA, C/DH
4 CIL., 2.4 L	2003	T42121 POLEA BANDA DE TIEMPO 31118 TAPON DE ACEITE 31838 TAPON DE GASOLINA 31836 TAPON DE GASOLINA 31518 TAPON DE RADIADOR 31528 TAPON DE RADIADOR T43008 TENSOR ARBOL DE LEVAS	SIN LLAVE REGULAR CON LLAVE REGULAR (16 lbs) Con Palanca (16 lbs) Sin Palanca	4 CIL., 2.0 L	1997	K040350 ALT. T245 BANDA ARBOL DE LEVAS T246 BANDA ARBOL DE LEVAS BDH-5177 BOMBA DE DIR. HIDR. 6480 GS D.H. 6413 GS D.H. 91949 EDH TCK245 KIT DE DISTRIBUCION TCK246 KIT DE DISTRIBUCION CH-110312 MANGUERA INF. 22460 MANGUERA INF. 12T172 MANGUERA INF. FLEXIBLE CH-110301 MANGUERA SUP. CH-110021 MANGUERA SUP. 22120 MANGUERA SUP. 12T150 MANGUERA SUP. FLEXIBLE 31118 TAPON DE ACEITE 31734 TAPON DE GASOLINA 31748 TAPON DE GASOLINA 31778 TAPON DE GASOLINA 31528 TAPON DE RADIADOR T43001 TENSOR ARBOL DE LEVAS T41002 TENSOR ARBOL DE LEVAS 33849 TERMOSTATO	195°F C/AA C/AA PRESION SIN LLAVE REGULAR CON LLAVE REGULAR (16 lbs) Sin Palanca (16 lbs) Con Palanca 195°F C/AA, C/DH C/AA, C/DH PRESION C/DOHC C/AA S/AA C/AA C/AA C/AA C/AA CON LLAVE C/CONT. DE EMI: SIN LLAVE REGULAR CON LLAVE REGULAR (16 lbs) Sin Palanca 195°F C/AA, C/DH C/AA, C/DH PRESION C/SOHC
4 CIL., 2.0 L	2002	K040517 A.A., D.H. K040335 ALT. T245 BANDA ARBOL DE LEVAS 30T 5/8" CALEF. A TUBO-1 30T 5/8" CALEF. A TUBO-2 92072 EDH TCK245 KIT DE DISTRIBUCION 22552 MANGUERA INF. 20893 MANGUERA SUP. 31118 TAPON DE ACEITE 31838 TAPON DE GASOLINA 31836 TAPON DE GASOLINA 31528 TAPON DE RADIADOR 31518 TAPON DE RADIADOR T41002 TENSOR ARBOL DE LEVAS T43001 TENSOR ARBOL DE LEVAS 33849 TERMOSTATO	PRESION	4 CIL., 2.0 L	1998	30T 5/8" TUBO-2 A TUBO-4 30T 5/8" TUBO-3 A B.A. K040517 A.A. & D.H. K040335 ALT. T245 BANDA ARBOL DE LEVAS T246 BANDA ARBOL DE LEVAS K040514 D.H. 92072 EDH TCK245 KIT DE DISTRIBUCION 22552 MANGUERA INF. 20893 MANGUERA SUP. 31118 TAPON DE ACEITE 31836 TAPON DE GASOLINA 31838 TAPON DE GASOLINA 31518 TAPON DE RADIADOR 31528 TAPON DE RADIADOR T41002 TENSOR ARBOL DE LEVAS T43001 TENSOR ARBOL DE LEVAS 33849 TERMOSTATO	195°F C/AA C/AA PRESION CON LLAVE REGULAR SIN LLAVE REGULAR (16 lbs) Con Palanca (16 lbs) Sin Palanca 195°F D.H. C/AA PRESION CON LLAVE REGULAR SIN LLAVE REGULAR (16 lbs) Con Palanca (16 lbs) Sin Palanca 195°F D.H. C/AA PRESION
4 CIL., 2.0 L	2001	30T 5/8" TUBO-2 A TUBO-4 30T 5/8" TUBO-3 A B.A. K040517 A.A. & D.H. K040335 ALT. T245 BANDA ARBOL DE LEVAS T246 BANDA ARBOL DE LEVAS K040514 D.H. 92072 EDH TCK245 KIT DE DISTRIBUCION 22552 MANGUERA INF. 20893 MANGUERA SUP. 31118 TAPON DE ACEITE 31836 TAPON DE GASOLINA 31838 TAPON DE GASOLINA 31518 TAPON DE RADIADOR 31528 TAPON DE RADIADOR T41002 TENSOR ARBOL DE LEVAS T43001 TENSOR ARBOL DE LEVAS 33849 TERMOSTATO	PRESION	4 CIL., 2.0 L	1997	30T 5/8" TUBO-2 A TUBO-4 30T 5/8" TUBO-3 A B.A. K040517 A.A. & D.H. K040335 ALT. T245 BANDA ARBOL DE LEVAS T246 BANDA ARBOL DE LEVAS K040514 D.H. 92072 EDH TCK245 KIT DE DISTRIBUCION 22552 MANGUERA INF. 20893 MANGUERA SUP. 31118 TAPON DE ACEITE 31838 TAPON DE GASOLINA 31836 TAPON DE GASOLINA 31518 TAPON DE RADIADOR 31528 TAPON DE RADIADOR T41002 TENSOR ARBOL DE LEVAS T43001 TENSOR ARBOL DE LEVAS 33849 TERMOSTATO	195°F C/AA C/AA PRESION CON LLAVE REGULAR SIN LLAVE REGULAR (16 lbs) Con Palanca (16 lbs) Sin Palanca 195°F D.H. C/AA PRESION CON LLAVE REGULAR SIN LLAVE REGULAR (16 lbs) Con Palanca (16 lbs) Sin Palanca 195°F D.H. C/AA PRESION
4 CIL., 2.0 L	2000	K040440 TRANSMISION DE ACCESORIOS K040335 ALT. T246 BANDA ARBOL DE LEVAS T245 BANDA ARBOL DE LEVAS K040440 D.H. K040514 D.H. K040517 D.H. & A.A. 92072 EDH TCK245 KIT DE DISTRIBUCION 22552 MANGUERA INF. 20893 MANGUERA SUP. 31118 TAPON DE ACEITE 31838 TAPON DE GASOLINA 31836 TAPON DE GASOLINA 31518 TAPON DE RADIADOR 31528 TAPON DE RADIADOR T41002 TENSOR ARBOL DE LEVAS	SIN LLAVE REGULAR CON LLAVE REGULAR (16 lbs) Con Palanca (16 lbs) Sin Palanca	4 CIL., 2.0 L	1997	30T 5/8" TUBO-2 A TUBO-4 30T 5/8" TUBO-3 A B.A. K040517 A.A. & D.H. K040335 ALT. T245 BANDA ARBOL DE LEVAS T246 BANDA ARBOL DE LEVAS K040514 D.H. 92072 EDH TCK245 KIT DE DISTRIBUCION 22552 MANGUERA INF. 20893 MANGUERA SUP. 31118 TAPON DE ACEITE 31838 TAPON DE GASOLINA 31836 TAPON DE GASOLINA 31518 TAPON DE RADIADOR 31528 TAPON DE RADIADOR T41002 TENSOR ARBOL DE LEVAS T43001 TENSOR ARBOL DE LEVAS 33849 TERMOSTATO	195°F C/AA C/AA PRESION SIN LLAVE REGULAR CON LLAVE REGULAR (16 lbs) Con Palanca (16 lbs) Sin Palanca 195°F D.H. C/AA PRESION CON LLAVE REGULAR SIN LLAVE REGULAR (16 lbs) Con Palanca (16 lbs) Sin Palanca 195°F D.H. C/AA PRESION

4 CIL, 2.0 L	1997	31518 T43001 T41002 33849	TAPON DE RADIADOR TENSOR ARBOL DE LEVAS TENSOR ARBOL DE LEVAS TERMOSTATO	(16 lbs) Con Palanca   195°F

		31278 31836 31838 31525 38167 33919	TAPON DE ACEITE TAPON DE GASOLINA TAPON DE GASOLINA TAPON DE RADIADOR TENSOR MICRO-V TERMOSTATO	CON LLAVE  18 LIBRAS 195°F
		T295 38018 38009 K060866 31838 31836	BANDA ARBOL DE LEVAS POLEA POLEA SERPENTIN TAPON DE GASOLINA TAPON DE GASOLINA	LISA SUPERIOR RANURADA INFERIOR  CON LLAVE











**NITRO**

V-6, 3.7 L	2010	19510 19511 23411 23410 K060868 31278 31836 31838 31525	MANGUERA CALEFACCION MANGUERA CALEFACCION MANGUERA INF. MANGUERA SUP. SERPENTIN TAPON DE ACEITE TAPON DE GASOLINA TAPON DE GASOLINA TAPONES DE RADIADOR	ENTRADA SALIDA     CON LLAVE 18 LBS.
V-6, 4.0 L	2010	T295 K040374SF 91030 TCK295A 23429 38009 38018 K060866 31299 31838 31836 31525 T43197 33849	BANDA ARBOL DE LEVAS D.H. STRECH FIT HERRAMIENTA INST. STRECH F KIT DE DISTRIBUCION MANGUERA SUP. POLEA POLEA SERPENTIN TAPON DE ACEITE TAPON DE GASOLINA TAPON DE GASOLINA TAPONES DE RADIADOR TENSOR TERMOSTATOS	TUBO A RADIADOR RANURADA LISA     CON LLAVE 18 LBS. 195°
V-6, 3.7 L	2009	19510 19511 23411 23410 K060868 31278 31836 31838 31525	MANGUERA CALEFACCION MANGUERA CALEFACCION MANGUERA INF. MANGUERA SUP. SERPENTIN TAPON DE ACEITE TAPON DE GASOLINA TAPON DE GASOLINA TAPONES DE RADIADOR	ENTRADA SALIDA    CON LLAVE 18 LBS.
V-6, 4.0 L	2009	T295 K040374SF 91030 TCK295A 23429 38018 38009 K060866 31299 31838 31836 31525 T43197 33849	BANDA ARBOL DE LEVAS D.H. STRECH FIT HERRAMIENTA INST. STRECH F KIT DE DISTRIBUCION MANGUERA SUP. POLEA POLEA SERPENTIN TAPON DE ACEITE TAPON DE GASOLINA TAPON DE GASOLINA TAPONES DE RADIADOR TENSOR TERMOSTATOS	TUBO A RADIADOR RANURADA LISA     CON LLAVE 18 LBS. 195°
V-6, 3.7 L	2008	23411 23410 38009 38001 K060868 31278 31836 31838 31525 38167 33919	MANGUERA INF. MANGUERA SUP. POLEA POLEA SERPENTIN TAPON DE ACEITE TAPON DE GASOLINA TAPON DE GASOLINA TAPONES DE RADIADOR TENSOR MICRO-V TERMOSTATO	CON LLAVE 18 LIBRAS 195°F
V-6, 4.0 L	2008	T295 38018 38009 K060866 31836 31838	BANDA ARBOL DE LEVAS POLEA POLEA SERPENTIN TAPON DE GASOLINA TAPON DE GASOLINA	LISA SUPERIOR RANURADA INFERIOR  CON LLAVE
V-6, 3.7 L	2007	23411 23410 38001 38009 K060868	MANGUERA INF. MANGUERA SUP. POLEA POLEA SERPENTIN	











**RAM 1500**

V-6, 4.0 L	2007	T295 38018 38009 K060866 31838 31836	BANDA ARBOL DE LEVAS POLEA POLEA SERPENTIN TAPON DE GASOLINA TAPON DE GASOLINA	CON LLAVE  18 LIBRAS 195°F
V-6, 3.7 L	2009	K060888 31836 31838 31528 33919	SERPENTIN TAPON DE GASOLINA TAPON DE GASOLINA TAPONES DE RADIADOR TERMOSTATOS	CON LLAVE  16 LBS. 195°
V-6, 3.7 L	2008	22761 K060888 31838 31836 31528 33919	MANGUERA SUP. SERPENTIN TAPON DE GASOLINA TAPON DE GASOLINA TAPONES DE RADIADOR TERMOSTATOS	CON LLAVE  16 LBS. 195°
V-6, 3.7 L	2007	22761 38009 38015 K060876 31836 31838	MANGUERA SUP. POLEA POLEA SERPENTIN TAPON DE GASOLINA TAPON DE GASOLINA	CON LLAVE  16 LBS. 195°
V-6, 3.7 L	2006	22761 38015 38009 K060876 31836 31838	MANGUERA SUP. POLEA POLEA SERPENTIN TAPON DE GASOLINA TAPON DE GASOLINA	CON LLAVE  16 LBS. 195°
V-6, 3.7 L	2005	22746 22761 38042 K060876 31278 31838 31528 38167 33919	MANG. INF. MANG. SUP. POLEA LOCA SERPENTIN TAPON DE ACEITE TAPON DE GASOLINA TAPON DE RADIADOR TENSOR MICRO-V TERMOSTATO	C/AA, C/DH  SIN LLAVE REGULAR (16 lbs) Sin Palanca 195°F
V-6, 3.9 L	2005	BDH-7108	BOMBA DE DIR. HIDR.	
V-6, 3.7 L	2004	22746 22761 K060876 31278 31838 31528 38167 33919	MANG. INF. MANG. SUP. SERPENTIN TAPON DE ACEITE TAPON DE GASOLINA TAPON DE RADIADOR TENSOR MICRO-V TERMOSTATO	C/AA, C/DH  SIN LLAVE REGULAR (16 lbs) Sin Palanca 195°F
V-6, 3.9 L	2004	BDH-7108	BOMBA DE DIR. HIDR.	
6 CIL, 3.9 L	2003	22443 22467 K070903 38042	MANGUERA INF. MANGUERA SUP. SERPENTIN POLEA LOCA	S/AA
V-6, 3.7 L	2003	38042 K060882 31838 31528	POLEA LOCA SERPENTIN TAPON DE GASOLINA TAPON DE RADIADOR	C/AA, C/DH SIN LLAVE REGULAR (16 lbs) Sin Palanca
V-6, 3.9 L	2003	BDH-7108	BOMBA DE DIR. HIDR.	
V-6, 3.7 L	2002	38042 K060882 31118 31838 31528	POLEA LOCA SERPENTIN TAPON DE ACEITE TAPON DE GASOLINA TAPON DE RADIADOR	C/AA, C/DH  SIN LLAVE REGULAR (16 lbs) Sin Palanca
V-6, 3.9 L	2002	BDH-7108	BOMBA DE DIR. HIDR.	



    				    					
V-8, 5.9 L	2002	K070975 31118 31838 31528 38116 33509	SERPENTIN TAPON DE ACEITE TAPON DE GASOLINA TAPON DE RADIADOR TENSOR MICRO-V TERMOSTATO	C/AA SIN LLAVE REGULAR (16 lbs) Sin Palanca 195°F	V-8, 5.9 L	1997	K070975 38116 22038 CH-117592 CH-115591 38016	SERPENTIN TENSOR MICRO-V MANG. DE PASO MANG. INF. MANG. SUP. POLEA	C/AA
V-8, 5.2 L	2001	BDH-7108 365260(800) 38016 38116	BOMBA DE DIR. HIDR. EDH POLEA TENSOR MICRO-V	PRESION			K070975 K071130 K070880 K071040 38116	SERPENTIN SERPENTIN SERPENTIN SERPENTIN TENSOR MICRO-V	C/AA VIN Z C/AA S/AA VIN Z S/AA
V-8, 5.9 L	2001	BDH-7108 365260(800) K070975 38116	BOMBA DE DIR. HIDR. EDH SERPENTIN TENSOR MICRO-V	PRESION C/AA					
V-8, 5.2 L	2000	BDH-7108 365260(800) 22038 CH-117592 CH-115591 38016 K070975 K070880 38116	BOMBA DE DIR. HIDR. EDH MANG. DE PASO MANG. INF. MANG. SUP. POLEA SERPENTIN SERPENTIN TENSOR MICRO-V	PRESION C/AA S/AA	V-8, 5.7 L	2007	23068 22777 38058 K071013 31296 31838 31528 38382 48792	MANG. INF. MANG. SUP. POLEA LOCA SERPENTIN TAPON DE ACEITE TAPON DE GASOLINA TAPON DE RADIADOR TENSOR MICRO-V TERMOSTATO	SIN LLAVE REGULAR (16 lbs) Sin Palanca 203°F
V-8, 5.9 L	2000	BDH-7108 365260(800) 22038 CH-117592 CH-115591 38016 K071130 K070975 K070880 K071040 38116	BOMBA DE DIR. HIDR. EDH MANG. DE PASO MANG. INF. MANG. SUP. POLEA SERPENTIN SERPENTIN SERPENTIN TENSOR MICRO-V	PRESION C/AA C/AA VIN Z S/AA VIN Z S/AA	V-8, 5.7 L	2006	23068 22777 38058 K071013 31296 31838 31528 38382 48792	MANG. INF. MANG. SUP. POLEA LOCA SERPENTIN TAPON DE ACEITE TAPON DE GASOLINA TAPON DE RADIADOR TENSOR MICRO-V TERMOSTATO	SIN LLAVE REGULAR (16 lbs) Sin Palanca 203°F
V-8, 5.2 L	1999	BDH-7108 365260(800) 22038 CH-117592 CH-115591 38016 K070975 K070880 38116	BOMBA DE DIR. HIDR. EDH MANG. DE PASO MANG. INF. MANG. SUP. POLEA SERPENTIN SERPENTIN TENSOR MICRO-V	PRESION C/AA S/AA	V-8, 5.7 L	2005	23068 22777 38058 K071013 31296 31838 31528 38382 48792	MANG. INF. MANG. SUP. POLEA LOCA SERPENTIN TAPON DE ACEITE TAPON DE GASOLINA TAPON DE RADIADOR TENSOR MICRO-V TERMOSTATO	SIN LLAVE REGULAR (16 lbs) Sin Palanca 203°F
V-8, 5.9 L	1999	BDH-7108 365260(800) 22038 CH-117592 CH-115591 38016 K071040 K070880 K070975 K071130 38116	BOMBA DE DIR. HIDR. EDH MANG. DE PASO MANG. INF. MANG. SUP. POLEA SERPENTIN SERPENTIN SERPENTIN TENSOR MICRO-V	PRESION S/AA S/AA VIN Z C/AA VIN Z C/AA	V-8, 5.7 L	2004	23068 22777 38058 K071013 31296 31838 31528 38382 48792	MANG. INF. MANG. SUP. POLEA LOCA SERPENTIN TAPON DE ACEITE TAPON DE GASOLINA TAPON DE RADIADOR TENSOR MICRO-V TERMOSTATO	SIN LLAVE REGULAR (16 lbs) Sin Palanca 203°F
V-8, 5.2 L	1998	22038 CH-117592 CH-115591 38016 K070975 K070880 38116	MANG. DE PASO MANG. INF. MANG. SUP. POLEA SERPENTIN SERPENTIN TENSOR MICRO-V	C/AA S/AA	V-8, 5.9 L	2002	22038 22083 22043 38016 K080810 K070975 38116	MANG. DE PASO MANG. INF. MANG. SUP. POLEA SERPENTIN SERPENTIN TENSOR MICRO-V	SIN LLAVE REGULAR (16 lbs) Sin Palanca 203°F 3/4 TON 3/4 TON 1 TON C/AA
V-8, 5.9 L	1998	22038 CH-117592 CH-115591 38016 K071040 K071130 K070880 K070975 38116	MANG. DE PASO MANG. INF. MANG. SUP. POLEA SERPENTIN SERPENTIN SERPENTIN TENSOR MICRO-V	S/AA C/AA S/AA VIN Z C/AA VIN Z	V-8, 5.9 L	2001	CH-117592 CH-115591 38016 K070975 K070880 38116	MANG. INF. MANG. SUP. POLEA SERPENTIN SERPENTIN TENSOR MICRO-V	C/AA S/AA
V-8, 5.2 L	1997	22038 CH-117592 CH-115591 38016 K070880	MANG. DE PASO MANG. INF. MANG. SUP. POLEA SERPENTIN	S/AA	V-8, 5.9 L	2000	CH-117592 CH-115591 38016	MANG. INF. MANG. SUP. POLEA	C/AA S/AA

**RAM 3500**

									
V-8, 5.9 L	2000	K071130 K070975 K071040 K070880 38116	SERPENTIN SERPENTIN SERPENTIN SERPENTIN TENSOR MICRO-V	C/AA VIN 5 C/AA VIN Z S/AA VIN 5 S/AA VIN Z			K081265 K081102 31118 31838 38285 14289	SERPENTIN SERPENTIN TAPON DE ACEITE TAPON DE GASOLINA TENSOR MICRO-V TERMOSTATO	C/AA S/AA  SIN LLAVE REGULAR  195°F
V-8, 5.9 L	1999	CH-117592 CH-115591 38016 K070975 K071130 K071040 K070880 38116	MANG. INF. MANG. SUP. POLEA SERPENTIN SERPENTIN SERPENTIN SERPENTIN TENSOR MICRO-V		V-6, 5.9 L DIESEL	2005	22893 22892 K081265 K081102 31118 31838 38285 14289	MANG. INF. MANG. SUP. SERPENTIN SERPENTIN TAPON DE ACEITE TAPON DE GASOLINA TENSOR MICRO-V TERMOSTATO	195°F  C/AA S/AA  SIN LLAVE REGULAR
V-8, 5.9 L	1998	CH-117592 CH-115591 38016 K071040 K071130 K070880 K070975 38116	MANG. INF. MANG. SUP. POLEA SERPENTIN SERPENTIN SERPENTIN SERPENTIN TENSOR MICRO-V		V-6, 5.9 L DIESEL	2004	22893 22892 K081265 K081102 31118 31838 38285 14289	MANG. INF. MANG. SUP. SERPENTIN SERPENTIN TAPON DE ACEITE TAPON DE GASOLINA TENSOR MICRO-V TERMOSTATO	195°F  C/AA S/AA  SIN LLAVE REGULAR
V-8, 5.9 L	1997	CH-117592 CH-115591 38016 K070975 K071130 K070880 K071040 38116	MANG. INF. MANG. SUP. POLEA SERPENTIN SERPENTIN SERPENTIN SERPENTIN TENSOR MICRO-V		V-6, 5.9 L DIESEL	2003	22893 22892 K081265 K081102 31118 31838 38285 14289	MANG. INF. MANG. SUP. SERPENTIN SERPENTIN TAPON DE ACEITE TAPON DE GASOLINA TENSOR MICRO-V TERMOSTATO	195°F  C/AA S/AA  SIN LLAVE REGULAR

**RAM 4000**

V-6, 6.7 L DIESEL	2009	18710 18774 36315 K081264 K081102 31118 31838 31836 31528 38285 33915	MANGUERA CALEFACCION MANGUERA CALEFACCION POLEA SERPENTIN SERPENTIN TAPON DE ACEITE TAPON DE GASOLINA TAPON DE GASOLINA TAPONES DE RADIADOR TENSOR TERMOSTATOS	SALIDA ENTRADA  CON A.A. SIN A.A.  CON LLAVE 16 LBS. 190°	V-8, 5.9 L	2002	22038 22083 22043 38016 K080810 K070975 38116	MANG. DE PASO MANG. INF. MANG. SUP. POLEA SERPENTIN SERPENTIN TENSOR MICRO-V	195°F 3/4 TON 3/4 TON  1 TON C/AA
V-6, 5.9 L DIESEL	2008	36315 K081102 K081264 31118 31836 31838 31528 38285 33915	POLEA SERPENTIN SERPENTIN TAPON DE ACEITE TAPON DE GASOLINA TAPON DE GASOLINA TAPONES DE RADIADOR TENSOR TERMOSTATOS	SIN A.A. CON A.A.  CON LLAVE 16 LBS. 190°	V-8, 5.9 L	2000	CH-117592 CH-115591 38016 K070975 K071130 K070880 K071040 38116	MANG. INF. MANG. SUP. POLEA SERPENTIN SERPENTIN SERPENTIN SERPENTIN TENSOR MICRO-V	C/AA, C/DH C/AA, C/DH  C/AA VIN Z C/AA VIN 5 S/AA VIN Z S/AA VIN 5
V-6, 6.7 L DIESEL	2008	18710 18774 22893 22892 36315 K081102 K081264 31118 31838 31836 31528 38285 33915	MANGUERA CALEFACCION MANGUERA CALEFACCION MANGUERA INF. MANGUERA SUP. POLEA SERPENTIN SERPENTIN TAPON DE ACEITE TAPON DE GASOLINA TAPON DE GASOLINA TAPONES DE RADIADOR TENSOR TERMOSTATOS	SALIDA ENTRADA  SIN A.A. CON A.A.  CON LLAVE 16 LBS. 190°	V-8, 5.9 L	1999	CH-117592 CH-115591 38016 K070880 K070975 K071040 K071130 38116	MANG. INF. MANG. SUP. POLEA SERPENTIN SERPENTIN SERPENTIN SERPENTIN TENSOR MICRO-V	C/AA, C/DH C/AA, C/DH  S/AA VIN Z C/AA VIN Z S/AA VIN 5 C/AA VIN 5
V-6, 5.9 L DIESEL	2007	22893 22892 K081265 K081102 31118 31838 38285 14289	MANG. INF. MANG. SUP. SERPENTIN SERPENTIN TAPON DE ACEITE TAPON DE GASOLINA TENSOR MICRO-V TERMOSTATO	C/AA S/AA  SIN LLAVE REGULAR 195°F	V-8, 5.9 L	1997	CH-117592 CH-115591 38016 K071040 K071130 K070880 K070975 38116	MANG. INF. MANG. SUP. POLEA SERPENTIN SERPENTIN SERPENTIN SERPENTIN TENSOR MICRO-V	C/AA, C/DH C/AA, C/DH  S/AA VIN 5 C/AA VIN 5 S/AA VIN Z C/AA VIN Z
V-6, 5.9 L DIESEL	2006	22893 22892	MANG. INF. MANG. SUP.				38116	TENSOR MICRO-V	C/AA VIN Z





**RAM 6500 DIESEL**

PERKINS F-IV 6L-34	1997	8573GS CH-114582 CH-114581	BANDA MANG. INF. MANG. SUP.	ALT. B.A., VENT.
--------------------	------	----------------------------------	-----------------------------------	------------------

V-6, 3.9 L

1998

K071005	SERPENTIN	C/AA
38116	SENSOR MICRO-V	
22125	MANGUERA INF.	C/AA
CH-116391	MANGUERA SUP.	C/AA
K070903	SERPENTIN	S/AA
K071005	SERPENTIN	C/AA
22125	MANGUERA INF.	C/AA
CH-116391	MANGUERA SUP.	C/AA
K071005	SERPENTIN	C/AA
K070903	SERPENTIN	S/AA

**RAM CHARGER**

V-8, 5.9 L	2001	365260(800) 22038 CH-117592 CH-115591 K071040 K071130 K070975	EDH MANGUERA DE PASO MANGUERA INF. MANGUERA SUP. SERPENTIN SERPENTIN SERPENTIN	PRESION
V-8, 5.9 L	2000	365260(800) 22038 CH-117592 CH-115591 K071040 K070880 K070975 K071130	EDH MANGUERA DE PASO MANGUERA INF. MANGUERA SUP. SERPENTIN SERPENTIN SERPENTIN SERPENTIN	SP, S/AA SP, C/AA C/AA, S/COMP PRESION
V-8, 5.9 L	1999	365260(800) 22038 CH-117592 CH-115591 K071040 K071130 K070975 K070880	EDH MANGUERA DE PASO MANGUERA INF. MANGUERA SUP. SERPENTIN SERPENTIN SERPENTIN SERPENTIN	SP, S/AA SL, S/AA C/AA, S/COMP SP, C/AA PRESION
V-8, 5.9 L	1998	365260(800) 22038 CH-117592 CH-115591 K071040 K070975	EDH MANGUERA DE PASO MANGUERA INF. MANGUERA SUP. SERPENTIN SERPENTIN	SP, S/AA SP, C/AA C/AA, S/COMP SL, S/AA PRESION
V-8, 5.9 L	1997	365260(800) 22038 CH-117592 CH-115591 K070975	EDH MANGUERA DE PASO MANGUERA INF. MANGUERA SUP. SERPENTIN	C/AA, S/COMP PRESION

V-6, 3.9 L

1997

**RAM MAXI VAN 2500**

V-8, 5.2 L	2002	30T 5/8" 30T 5/8" 30T 5/8" 30T 5/8" 22038 22396 22482 38016 K071005 K070903 30T 5/8" 30T 5/8" 30T 5/8" 30T 5/8" 38116 30T 5/8" 30T 5/8" 30T 5/8" 30T 5/8" 30T 5/8" 30T 5/8"	CALEF. A "T"-1 CALEF. A TUBO CALEF. A VALVULA CALEF. A VALVULA MANGUERA DE PASO MANGUERA INF. MANGUERA SUP. POLEA DEL TENSOR SERPENTIN SERPENTIN T-1 A TUBO-1 T-1 A TUBO-3 T-2 A MOTOR T-2 A TUBO-2 SENSOR MICRO-V TUBO-2 A TUBO-4 TUBO-3 A TUBO-5 VALVULA A "T"-2 VALVULA A MOTOR	C/Calefactor Auxiliar; C/AA S/Calefactor Auxiliar S/Calefactor Auxiliar C/Calefactor Auxiliar; C/AA C/Calefactor Auxiliar; C/AA C/Calefactor Auxiliar; C/AA C/Calefactor Auxiliar; C/AA C/AA S/AA C/AA C/Calefactor Auxiliar; C/AA C/Calefactor Auxiliar; C/AA C/Calefactor Auxiliar; C/AA S/Calefactor Auxiliar C/AA S/AA C/AA C/AA C/AA C/AA S/Calefactor Auxiliar
V-6, 3.9 L	2001	K070903 K071005	SERPENTIN SERPENTIN	S/AA C/AA
V-8, 5.2 L	2001	38016 K071005 K070903 38116	POLEA DEL TENSOR SERPENTIN SERPENTIN SENSOR MICRO-V	C/AA S/AA C/AA
V-6, 3.9 L	2000	K070903 K071005	SERPENTIN SERPENTIN	S/AA C/AA
V-8, 5.2 L	2000	38016 K070903 K071005 38116	POLEA DEL TENSOR SERPENTIN SERPENTIN SENSOR MICRO-V	S/AA C/AA C/AA
V-6, 3.9 L	1999	K071005 K070903	SERPENTIN SERPENTIN	C/AA S/AA
V-8, 5.2 L	1999	22038 CH-117592 22396 CH-115591 CH-110591 38016 K071005 K070903 38116	MANGUERA DE PASO MANGUERA INF. MANGUERA INF. MANGUERA SUP. MANGUERA SUP. POLEA DEL TENSOR SERPENTIN SERPENTIN SENSOR MICRO-V	C/AA C/AA C/AA C/AA C/AA C/AA C/AA S/AA
V-6, 3.9 L	1998	K071005 K070903 38116	SERPENTIN SERPENTIN SENSOR MICRO-V	C/AA S/AA C/AA
V-8, 5.2 L	1998	22038 CH-117592 22396 CH-110591 CH-115591 38016 K071005 K070903 38116	MANGUERA DE PASO MANGUERA INF. MANGUERA INF. MANGUERA SUP. MANGUERA SUP. POLEA DEL TENSOR SERPENTIN SERPENTIN SENSOR MICRO-V	C/AA C/AA C/AA C/AA C/AA C/AA C/AA S/AA
V-6, 3.9 L	1997	K071005 K070903	SERPENTIN SERPENTIN	C/AA S/AA
V-8, 5.2 L	1997	22038 CH-117592 22396 CH-110591 38016 K071005	MANGUERA DE PASO MANGUERA INF. MANGUERA INF. MANGUERA SUP. POLEA DEL TENSOR SERPENTIN	C/AA C/AA C/AA C/AA C/AA

**RAM MAXI VAN 1500**

V-6, 3.9 L	2002	30T 5/8" 30T 5/8" 30T 5/8" 30T 5/8" 22038 22443 22467 38016 K070903 K071005 30T 5/8" 30T 5/8" 30T 5/8" 30T 5/8" 30T 5/8" 31118 31838 31528 38116 33509 30T 5/8" 30T 5/8" 30T 5/8" 30T 5/8" 30T 5/8"	CALEF. A "T"-1 CALEF. A TUBO CALEF. A VALVULA CALEF. A VALVULA MANGUERA DE PASO MANGUERA INF. MANGUERA SUP. POLEA DEL TENSOR SERPENTIN SERPENTIN T-1 A TUBO-1 T-1 A TUBO-3 T-2 A MOTOR T-2 A TUBO-2 TAPON DE ACEITE TAPON DE GASOLINA TAPON DE RADIADOR SENSOR MICRO-V TERMOSTATO TUBO-2 A TUBO-4 TUBO-3 A TUBO-5 VALVULA A "T"-2 VALVULA A MOTOR	C/Calefactor Auxiliar; C/AA S/Calefactor Auxiliar S/Calefactor Auxiliar C/Calefactor Auxiliar; C/AA S/AA C/AA C/Calefactor Auxiliar; C/AA C/Calefactor Auxiliar; C/AA C/Calefactor Auxiliar; C/AA C/Calefactor Auxiliar; C/AA S/AA C/AA C/AA C/AA SIN LLAVE REGULAR (16 lbs) Sin Palanca 195°F C/Calefactor Auxiliar; C/AA C/Calefactor Auxiliar; C/AA C/Calefactor Auxiliar; C/AA S/Calefactor Auxiliar
V-6, 3.9 L	2001	K071005 K070903	SERPENTIN SERPENTIN	C/AA S/AA
V-6, 3.9 L	2000	K071005 K070903	SERPENTIN SERPENTIN	C/AA S/AA
V-6, 3.9 L	1999	22125 CH-116391 38016 K070903	MANGUERA INF. MANGUERA SUP. POLEA DEL TENSOR SERPENTIN	C/AA C/AA S/AA



V-8, 5.2 L	1997	K070903 38116	SERPENTIN TENSOR MICRO-V	S/AA
------------	------	------------------	-----------------------------	------



30T 5/8"	T-1 A TUBO-3	C/Calefactor Auxiliar; C/AA
30T 5/8"	T-2 A MOTOR	C/Calefactor Auxiliar; C/AA
30T 5/8"	T-2 A TUBO-2	C/Calefactor Auxiliar; C/AA
31118	TAPON DE ACEITE	
31838	TAPON DE GASOLINA	SIN LLAVE REGULAR
31528	TAPON DE RADIADOR	(16 lbs) Sin Palanca
38116	TENSOR MICRO-V	
33509	TERMOSTATO	195°F
30T 5/8"	TUBO-2 A TUBO-4	C/Calefactor Auxiliar; C/AA
30T 5/8"	TUBO-3 A TUBO-5	C/Calefactor Auxiliar; C/AA
30T 5/8"	VALVULA A "T"-2	C/Calefactor Auxiliar; C/AA
30T 5/8"	VALVULA A MOTOR	S/Calefactor Auxiliar
38016	POLEA DEL TENSOR	
K070903	SERPENTIN	S/AA
K071005	SERPENTIN	C/AA
38116	TENSOR MICRO-V	
CH-117592	MANGUERA INF.	C/AA, S/AA
22396	MANGUERA INF.	
CH-115591	MANGUERA SUP.	
22482	MANGUERA SUP.	
38016	POLEA DEL TENSOR	
K070903	SERPENTIN	S/AA
K071005	SERPENTIN	C/AA
38116	TENSOR MICRO-V	
CH-117592	MANGUERA INF.	C/AA, S/AA
22396	MANGUERA INF.	
CH-115591	MANGUERA SUP.	C/AA
22482	MANGUERA SUP.	
38016	POLEA DEL TENSOR	
K070903	SERPENTIN	S/AA
K071005	SERPENTIN	C/AA
38116	TENSOR MICRO-V	
22038	MANGUERA DE PASO	
21956	MANGUERA INF.	
CH-110591	MANGUERA SUP.	
38016	POLEA DEL TENSOR	
K070903	SERPENTIN	S/AA
K071005	SERPENTIN	C/AA
38116	TENSOR MICRO-V	

**RAM MAXI VAN 3500**

V-8, 5.9 L	2002	30T 5/8"	CALEF. A "T"-1	C/Calefactor Auxiliar; C/AA
		30T 5/8"	CALEF. A TUBO	S/Calefactor Auxiliar
		30T 5/8"	CALEF. A VALVULA	C/Calefactor Auxiliar; C/AA
		30T 5/8"	CALEF. A VALVULA	S/Calefactor Auxiliar
		22038	MANGUERA DE PASO	
		22396	MANGUERA INF.	
		22482	MANGUERA SUP.	
		38016	POLEA DEL TENSOR	
		K070903	SERPENTIN	S/AA
		K071005	SERPENTIN	C/AA
		30T 5/8"	T-1 A TUBO-1	C/Calefactor Auxiliar; C/AA
		30T 5/8"	T-1 A TUBO-3	C/Calefactor Auxiliar; C/AA
		30T 5/8"	T-2 A MOTOR	C/Calefactor Auxiliar; C/AA
		30T 5/8"	T-2 A TUBO-2	C/Calefactor Auxiliar; C/AA
		31118	TAPON DE ACEITE	
		31838	TAPON DE GASOLINA	SIN LLAVE REGULAR
		31528	TAPON DE RADIADOR	(16 lbs) Sin Palanca
		38116	TENSOR MICRO-V	
		33509	TERMOSTATO	195°F
		30T 5/8"	TUBO-2 A TUBO-4	C/Calefactor Auxiliar; C/AA
		30T 5/8"	TUBO-3 A TUBO-5	C/Calefactor Auxiliar; C/AA
		30T 5/8"	VALVULA A "T"-2	C/Calefactor Auxiliar; C/AA
		30T 5/8"	VALVULA A MOTOR	S/Calefactor Auxiliar
V-8, 5.9 L	2001	38016	POLEA DEL TENSOR	
		K070903	SERPENTIN	S/AA
		K071005	SERPENTIN	C/AA
		38116	TENSOR MICRO-V	
V-8, 5.9 L	2000	22038	MANGUERA DE PASO	
		22396	MANGUERA INF.	
		22482	MANGUERA SUP.	
		38016	POLEA DEL TENSOR	
		K071005	SERPENTIN	C/AA
		K070903	SERPENTIN	S/AA
		38116	TENSOR MICRO-V	
V-8, 5.9 L	1999	22038	MANGUERA DE PASO	C/AA
		CH-117592	MANGUERA INF.	C/AA
		22396	MANGUERA INF.	
		CH-115591	MANGUERA SUP.	C/AA
		22482	MANGUERA SUP.	
		38016	POLEA DEL TENSOR	
		K070903	SERPENTIN	S/AA
		K071005	SERPENTIN	C/AA
		38116	TENSOR MICRO-V	
V-8, 5.9 L	1998	22038	MANGUERA DE PASO	
		22396	MANGUERA INF.	
		22482	MANGUERA SUP.	
		38016	POLEA DEL TENSOR	
		K070903	SERPENTIN	S/AA
		K071005	SERPENTIN	C/AA
		38116	TENSOR MICRO-V	
V-8, 5.9 L	1997	22038	MANGUERA DE PASO	
		21956	MANGUERA INF.	
		CH-110591	MANGUERA SUP.	
		38016	POLEA DEL TENSOR	
		K070903	SERPENTIN	S/AA
		K071005	SERPENTIN	C/AA
		38116	TENSOR MICRO-V	

**RAM RUNNER**





V-10, 8.0 L	2000	21528	MANGUERA DE PASO	
		22067	MANGUERA INF.	
		22068	MANGUERA SUP.	
		K071130	SERPENTIN	C/AA
V-10, 8.0 L	1999	21528	MANGUERA DE PASO	
		22067	MANGUERA INF.	
		22068	MANGUERA SUP.	
		K071130	SERPENTIN	C/AA
V-10, 8.0 L	1998	21528	MANGUERA DE PASO	
		22067	MANGUERA INF.	
		22068	MANGUERA SUP.	
		K071130	SERPENTIN	C/AA
V-10, 8.0 L	1997	21528	MANGUERA DE PASO	
		22067	MANGUERA INF.	
		22068	MANGUERA SUP.	
		K071130	SERPENTIN	C/AA











**RAM MAXI WAGON 3500**

V-8, 5.9 L	2002	30T 5/8"	CALEF. A "T"-1	C/Calefactor Auxiliar; C/AA
		30T 5/8"	CALEF. A TUBO	S/Calefactor Auxiliar
		30T 5/8"	CALEF. A VALVULA	C/Calefactor Auxiliar; C/AA
		30T 5/8"	CALEF. A VALVULA	S/Calefactor Auxiliar
		22038	MANGUERA DE PASO	
		22396	MANGUERA INF.	
		22482	MANGUERA SUP.	
		38016	POLEA DEL TENSOR	
		K071005	SERPENTIN	C/AA
		K070903	SERPENTIN	S/AA
		30T 5/8"	T-1 A TUBO-1	C/Calefactor Auxiliar; C/AA

**RAM SERIES PICKUP**

V-10, 8.0 L	2003	38033	POLEA	
V-6, 3.7 L	2003	38009	POLEA	
		38001	POLEA	
		38042	POLEA DEL TENSOR	
		K060882	SERPENTIN	C/AA, C/DH
		31838	TAPON DE GASOLINA	SIN LLAVE REGULAR
		31528	TAPON DE RADIADOR	(16 lbs) Sin Palanca

									
V-6, 3.7 L	2003	38167	TENSOR MICRO-V			38033	POLEA		
V-8, 4.7L	2003	38009	POLEA			K070975	SERPENTIN	C/AA	
		38042	POLEA DEL TENSOR			K070880	SERPENTIN	S/AA	
		K060882	SERPENTIN	C/AA, C/DH		38116	TENSOR MICRO-V		
		31838	TAPON DE GASOLINA	SIN LLAVE REGULAR	V-8, 5.9 L	2001	365260(800):	EDH	PRESION
		31528	TAPON DE RADIADOR	(16 lbs) Sin Palanca		CH-117592	MANGUERA INF.	C/AA, C/DH	
6 CIL, 5.9 L Diesel	2002	22082	MANGUERA INF.			22083	MANGUERA INF.		
		18124	PASO			CH-115591	MANGUERA SUP.	C/AA, C/DH	
		K080653	SERPENTIN	S/AA		22043	MANGUERA SUP.		
		K080810	SERPENTIN	C/AA		22038	PASO		
		38157	TENSOR MICRO-V			38058	POLEA		
V-10, 8.0 L	2002	20338	TUBO-1 A MOTOR			38033	POLEA		
		22067	MANGUERA INF.			38016	POLEA DEL TENSOR		
		22068	MANGUERA SUP.			K070975	SERPENTIN	C/AA	
		21528	PASO			K071130	SERPENTIN	C/AA; Motor NS 5; Pickup Hea	
		38033	POLEA			K071040	SERPENTIN	Motor NS 5; Pickup Heavy Dut	
		K071130	SERPENTIN			K070880	SERPENTIN	S/AA	
V-6, 3.7 L	2002	38009	POLEA			38116	TENSOR MICRO-V	MOTOR SERIE Z	
		38001	POLEA			38180	TENSOR MICRO-V		
		38042	POLEA DEL TENSOR		6 CIL, 5.9 L Diesel	2000	22082	MANGUERA INF.	
		K060882	SERPENTIN	C/AA, C/DH		18124	PASO		
		31118	TAPON DE ACEITE			K080653	SERPENTIN	S/AA	
		31838	TAPON DE GASOLINA	SIN LLAVE REGULAR		K080810	SERPENTIN	C/AA	
		31528	TAPON DE RADIADOR	(16 lbs) Sin Palanca		38157	TENSOR MICRO-V		
V-8, 4.7L	2002	38167	TENSOR MICRO-V			20338	TUBO-1 A MOTOR		
		38009	POLEA		V-10, 8.0 L	2000	22067	MANGUERA INF.	
		38042	POLEA DEL TENSOR			22068	MANGUERA SUP.		
		K060882	SERPENTIN	C/AA, C/DH		21528	PASO		
		31118	TAPON DE ACEITE			38033	POLEA		
		31838	TAPON DE GASOLINA	SIN LLAVE REGULAR		38058	POLEA		
		31528	TAPON DE RADIADOR	(16 lbs) Sin Palanca		K071009	SERPENTIN	S/AA; C/Sist Emisiones Califorr	
V-8, 5.9 L	2002	30T 5/8"	CALEF. A TUBO	1/2 Ton		K071031	SERPENTIN	S/AA; C/Emisiones Fed p/alltitur	
		30T 5/8"	CALEF. A TUBO	1/2 Ton		K071130	SERPENTIN	C/AA	
		30T 5/8"	CALEF. A TUBO	1/2 Ton		38180	TENSOR MICRO-V		
		30T 5/8"	CALEF. A TUBO	1/2 Ton	V-6, 3.9 L	2000	365260(800):	EDH	PRESION
		30T 5/8"	CALEF. A VALVULA	1/2 Ton		22038	MANGUERA DE PASO		
		30T 5/8"	CALEF. A VALVULA	1/2 Ton		22125	MANGUERA INF.	C/AA, S/AA C/DH	
		30T 5/8"	CALEF. A VALVULA	1/2 Ton		CH-116391	MANGUERA SUP.	C/AA, S/AA, C/DH	
		30T 5/8"	CALEF. A VALVULA	1/2 Ton		22066	MANGUERA SUP.		
		22038	MANGUERA DE PASO			38033	POLEA		
		22083	MANGUERA INF.	3/4 Ton		38016	POLEA		
		22043	MANGUERA SUP.	3/4 Ton		K070975	SERPENTIN	C/AA, C/DH	
		38033	POLEA			K070880	SERPENTIN	S/AA, C/DH	
		38016	POLEA DEL TENSOR			38116	TENSOR MICRO-V		
		K080810	SERPENTIN	1 Ton	V-8, 5.2 L	2000	365260(800):	EDH	PRESION
		K070975	SERPENTIN	C/AA; L.D. Pickup; Motor núme		22038	MANGUERA DE PASO		
		38116	TENSOR MICRO-V	L.D. Pickup; Motor número de s		CH-117592	MANGUERA INF.	C/AA, C/DH	
6 CIL, 5.9 L Diesel	2001	22082	MANGUERA INF.			22083	MANGUERA INF.		
		18124	PASO			CH-115591	MANGUERA SUP.	C/AA, C/DH	
		K080653	SERPENTIN	S/AA		22043	MANGUERA SUP.		
		K080810	SERPENTIN	C/AA		38033	POLEA		
		38157	TENSOR MICRO-V			38016	POLEA		
V-10, 8.0 L	2001	20338	TUBO-1 A MOTOR			K070880	SERPENTIN	S/AA	
		22067	MANGUERA INF.			K071130	SERPENTIN	C/AA, C/DH	
		22068	MANGUERA SUP.			K070975	SERPENTIN	C/AA	
		21528	PASO			K071040	SERPENTIN	S/AA, C/DH	
		38033	POLEA			38116	TENSOR MICRO-V		
		K071130	SERPENTIN	C/AA	V-8, 5.9 L	2000	365260(800):	EDH	PRESION
		K071031	SERPENTIN	S/AA; C/Emisiones Fed p/alltitur		22038	MANGUERA DE PASO		
		K071009	SERPENTIN	S/AA; C/Sist Emisiones Califorr		CH-117592	MANGUERA INF.	C/AA, C/DH	
V-6, 3.9 L	2001	365260(800):	EDH			22083	MANGUERA INF.		
		22125	MANGUERA INF.	C/AA, S/AA C/DH		CH-115591	MANGUERA SUP.	C/AA, C/DH	
		CH-116391	MANGUERA SUP.	C/AA, S/AA, C/DH		22043	MANGUERA SUP.		
		22066	MANGUERA SUP.			38033	POLEA		
		22038	PASO			38058	POLEA		
		38016	POLEA			38016	POLEA DEL TENSOR		
		38033	POLEA			K070975	SERPENTIN	C/AA; Pickup normal; Motor NS	
		K070975	SERPENTIN	C/AA, C/DH		K071040	SERPENTIN	S/AA	
		K070880	SERPENTIN	S/AA, C/DH		K070880	SERPENTIN	S/AA; Pickup normal; Motor NS	
		38116	TENSOR MICRO-V			K071130	SERPENTIN	C/AA, C/DH	
V-8, 5.2 L	2001	365260(800):	EDH	PRESION		38116	TENSOR MICRO-V	MOTOR SERIE Z	
		22083	MANGUERA INF.		6 CIL, 5.9 L Diesel	1999	38180	TENSOR MICRO-V	
		22043	MANGUERA SUP.			22082	MANGUERA INF.		
		22038	PASO			22081	MANGUERA SUP.		
		38016	POLEA			18124	PASO		

									
6 CIL, 5.9 L Diesel	1999	K080653	SERPENTIN	S/AA			K070975	SERPENTIN	SL, C/AA
		K080810	SERPENTIN	C/AA			K071130	SERPENTIN	SP, C/AA
		38157	SENSOR MICRO-V				K071040	SERPENTIN	SP, S/AA
		20338	TUBO-1 A TERMOSTATO	C/Trans Auto			38116	SENSOR MICRO-V	MOTOR SERIE Z
V-10, 8.0 L	1999	22067	MANGUERA INF.	C/AA, C/DH			38180	SENSOR MICRO-V	
		22068	MANGUERA SUP.	C/AA, C/DH	CUMMINS 6B5.9	1997	K080806	SERPENTIN	
		21528	PASO		PERKINS F-IV 6L-3	1997	8573 GS	ALT. B.A., VENTILADOR	
		38058	POLEA				CH-114582	MANGUERA INF.	
		38033	POLEA				CH-114581	MANGUERA SUP.	
		K071031	SERPENTIN	S/AA	V-6, 3.9 L	1997	365260(800)	EDH	PRESION
		K071130	SERPENTIN	C/AA			22038	MANGUERA DE PASO	
V-6, 3.9 L	1999	38180	SENSOR MICRO-V				CH-116392	MANGUERA INF.	
		365260(800)	EDH	PRESION			CH-116391	MANGUERA SUP.	
		22038	MANGUERA DE PASO				38016	POLEA	
		22125	MANGUERA INF.	C/AA, S/AA C/DH			38033	POLEA	
		CH-116391	MANGUERA SUP.	C/AA, S/AA, C/DH			K070880	SERPENTIN	S/AA
		22066	MANGUERA SUP.				K070975	SERPENTIN	C/AA, C/DH
		38033	POLEA				38116	SENSOR MICRO-V	
		38016	POLEA		V-8, 5.2 L	1997	365260(800)	EDH	PRESION
		K070975	SERPENTIN	C/AA, C/DH			22038	MANGUERA DE PASO	
		K070880	SERPENTIN	S/AA, C/DH			CH-117592	MANGUERA INF.	
V-8, 5.2 L	1999	38116	SENSOR MICRO-V				CH-115591	MANGUERA SUP.	
		365260(800)	EDH	PRESION			38033	POLEA	
		22038	MANGUERA DE PASO				38016	POLEA	
		CH-117592	MANGUERA INF.				K070880	SERPENTIN	S/AA
		22083	MANGUERA INF.				K070975	SERPENTIN	C/AA
		CH-115591	MANGUERA SUP.		V-8, 5.9 L	1997	38116	SENSOR MICRO-V	
		22043	MANGUERA SUP.				365260(800)	EDH	PRESION
		38033	POLEA				22038	MANGUERA DE PASO	
		38016	POLEA				CH-117592	MANGUERA INF.	C/AA, C/DH
		K070975	SERPENTIN	C/AA			CH-115591	MANGUERA SUP.	C/AA, C/DH
		K070880	SERPENTIN	S/AA			38058	POLEA	
V-8, 5.9 L	1999	38116	SENSOR MICRO-V				38033	POLEA	
		365260(800)	EDH	PRESION			38016	POLEA DEL TENSOR	
		22038	MANGUERA DE PASO	LD, C/AA			K071040	SERPENTIN	SP, S/AA
		CH-117592	MANGUERA INF.	C/AA, C/DH			K070975	SERPENTIN	SL, C/AA
		CH-117592	MANGUERA INF.	LD, C/AA			K071130	SERPENTIN	SP, C/AA
		22083	MANGUERA INF.				K070880	SERPENTIN	SL, S/AA
		CH-115591	MANGUERA SUP.	C/AA, C/DH			38116	SENSOR MICRO-V	MOTOR SERIE Z
		22043	MANGUERA SUP.				38180	SENSOR MICRO-V	
		38033	POLEA						
		38058	POLEA						
		38016	POLEA DEL TENSOR						
		K071130	SERPENTIN	C/AA; Pickup Heavy Duty; Mot	V-6, 3.9 L	2001	22038	MANGUERA DE PASO	C/AA, C/DH
		K070880	SERPENTIN	S/AA; Pickup normal; Motor NS			22125	MANGUERA INF.	C/AA, C/DH
		K071040	SERPENTIN	S/AA; Pickup Heavy Duty; Mot			CH-116391	MANGUERA SUP.	C/AA, C/DH
		K070975	SERPENTIN	C/AA; Pickup normal; Motor NS			K071005	SERPENTIN	C/AA
		38116	SENSOR MICRO-V	MOTOR SERIE Z			K070903	SERPENTIN	S/AA
		38180	SENSOR MICRO-V		V-8, 5.2 L	2001	38016	POLEA DEL TENSOR	
V-6, 3.9 L	1998	365260(800)	EDH	PRESION			38116	SENSOR MICRO-V	
		22038	MANGUERA DE PASO		V-6, 3.9 L	2000	22443	MANGUERA INF.	
		22125	MANGUERA INF.				22467	MANGUERA SUP.	
		CH-116391	MANGUERA SUP.				K071005	SERPENTIN	C/AA
		38016	POLEA				K070903	SERPENTIN	S/AA
		38033	POLEA		V-8, 5.2 L	2000	22038	MANGUERA DE PASO	C/AA
		K070975	SERPENTIN	C/AA, C/DH			22396	MANGUERA INF.	C/AA
		K070880	SERPENTIN	S/AA			22482	MANGUERA SUP.	C/AA
		38116	SENSOR MICRO-V				38016	POLEA DEL TENSOR	
V-8, 5.2 L	1998	365260(800)	EDH	PRESION			38116	SENSOR MICRO-V	
		22038	MANGUERA DE PASO		V-6, 3.9 L	1999	22443	MANGUERA INF.	
		CH-117592	MANGUERA INF.				22467	MANGUERA SUP.	
		CH-115591	MANGUERA SUP.				K071005	SERPENTIN	C/AA
		38033	POLEA				K070903	SERPENTIN	S/AA
		38016	POLEA		V-8, 5.2 L	1999	22038	MANGUERA DE PASO	C/AA
		K070975	SERPENTIN	C/AA			22396	MANGUERA INF.	C/AA
		K070880	SERPENTIN	S/AA			22482	MANGUERA SUP.	C/AA
		38116	SENSOR MICRO-V				38016	POLEA DEL TENSOR	
V-8, 5.9 L	1998	365260(800)	EDH	PRESION			38116	SENSOR MICRO-V	
		22038	MANGUERA DE PASO		V-6, 3.9 L	1998	22443	MANGUERA INF.	
		CH-117592	MANGUERA INF.	C/AA, C/DH			22467	MANGUERA SUP.	
		CH-115591	MANGUERA SUP.	C/AA, C/DH			K070903	SERPENTIN	S/AA
		38033	POLEA				K071005	SERPENTIN	C/AA
		38058	POLEA		V-8, 5.2 L	1998	22038	MANGUERA DE PASO	C/AA
		38016	POLEA DEL TENSOR				22396	MANGUERA INF.	C/AA
		K070880	SERPENTIN	SL, S/AA			22482	MANGUERA SUP.	C/AA

**RAM WAGON 1500**



V-8, 5.2 L	1998	38016	POLEA DEL TENSOR	
		38116	TENSOR MICRO-V	
V-6, 3.9 L	1997	21956	MANGUERA INF.	
		CH-110591	MANGUERA SUP.	
		K070903	SERPENTIN	S/AA
		K071005	SERPENTIN	C/AA
V-8, 5.2 L	1997	22038	MANGUERA DE PASO	
		21956	MANGUERA INF.	
		21912	MANGUERA SUP.	
		38016	POLEA DEL TENSOR	
		38116	TENSOR MICRO-V	

V-8, 5.2 L	2001	38116	TENSOR MICRO-V	
		30T 5/8"	TUBO-2 A TUBO-4	C/Calefactor Auxiliar; C/AA
		30T 5/8"	TUBO-3 A TUBO-5	C/Calefactor Auxiliar; C/AA
		30T 5/8"	VALVULA A "T"-2	C/Calefactor Auxiliar; C/AA
		30T 5/8"	VALVULA A MOTOR	S/Calefactor Auxiliar
V-8, 5.2 L	2001	CH-117592	MANGUERA INF.	C/AA, C/DH
		CH-115591	MANGUERA SUP.	C/AA, C/DH
		K071005	SERPENTIN	C/AA, C/DH
V-8, 5.9 L	2001	K071005	SERPENTIN	C/AA, C/DH
V-8, 5.2 L	2000	365260(800)	EDH	PRESION
		CH-117592	MANGUERA INF.	C/AA, C/DH
		CH-115591	MANGUERA SUP.	C/AA, C/DH
		K071005	SERPENTIN	C/AA, C/DH
		31118	TAPON DE ACEITE	
		31838	TAPON DE GASOLINA	SIN LLAVE REGULAR
		31523	TAPON DE RADIADOR	(16 lbs) Sin Palanca
		33509	TERMOSTATO	195°F
V-8, 5.9 L	2000	K071005	SERPENTIN	C/AA, C/DH

**RAM WAGON 2500**

V-8, 5.2 L	2001	22038	MANGUERA DE PASO	C/AA, C/DH
		CH-117592	MANGUERA INF.	C/AA, C/DH
		CH-115591	MANGUERA SUP.	C/AA, C/DH
		38016	POLEA DEL TENSOR	
		K070903	SERPENTIN	S/AA
		K071005	SERPENTIN	C/AA
		38116	TENSOR MICRO-V	
V-8, 5.9 L	2001	K071005	SERPENTIN	C/AA
		K070903	SERPENTIN	S/AA
V-8, 5.2 L	2000	22038	MANGUERA DE PASO	
		22396	MANGUERA INF.	
		22482	MANGUERA SUP.	
		38016	POLEA DEL TENSOR	
		K070903	SERPENTIN	S/AA
		K071005	SERPENTIN	C/AA
		38116	TENSOR MICRO-V	
V-8, 5.9 L	2000	K070903	SERPENTIN	S/AA
		K071005	SERPENTIN	C/AA
V-8, 5.2 L	1999	22038	MANGUERA DE PASO	
		22396	MANGUERA INF.	
		22482	MANGUERA SUP.	
		38016	POLEA DEL TENSOR	
		K071005	SERPENTIN	C/AA
		K070903	SERPENTIN	S/AA
		38116	TENSOR MICRO-V	
V-8, 5.9 L	1999	K071005	SERPENTIN	C/AA
		K070903	SERPENTIN	S/AA
V-8, 5.2 L	1998	22038	MANGUERA DE PASO	
		22396	MANGUERA INF.	
		22482	MANGUERA SUP.	
		38016	POLEA DEL TENSOR	
		K071005	SERPENTIN	C/AA
		K070903	SERPENTIN	S/AA
		38116	TENSOR MICRO-V	
V-8, 5.9 L	1998	K071005	SERPENTIN	C/AA
		K070903	SERPENTIN	S/AA
V-8, 5.2 L	1997	22038	MANGUERA DE PASO	
		21956	MANGUERA INF.	
		21912	MANGUERA SUP.	
		38016	POLEA DEL TENSOR	
		K070903	SERPENTIN	S/AA
		K071005	SERPENTIN	C/AA
		38116	TENSOR MICRO-V	
V-8, 5.9 L	1997	K071005	SERPENTIN	C/AA
		K070903	SERPENTIN	S/AA

**STRATUS**

4 CIL, 2.0 L	2006	T265	BANDA ARBOL DE LEVAS	DOHC
		K040353	SERPENTIN	D.H. DOHC
		K060490	SERPENTIN	ALT. & A.A. DOHC
		31118	TAPON DE ACEITE	
		31838	TAPON DE GASOLINA	SIN LLAVE REGULAR
		31525	TAPON DE RADIADOR	(18 lbs) Sin Palanca
		33849	TERMOSTATO	195°F
4 CIL, 2.4 L	2006	T265	BANDA ARBOL DE LEVAS	
		22629	MANG. INF.	
		22357	MANG. SUP.	CORTAR A MEDIDA
		T42121	POLEA BANDA DE TIEMPO	
		K040353	SERPENTIN	D.H. DOHC
		K050370	SERPENTIN	D.H. C/SOHC
		K060486	SERPENTIN	ALT. & A.A. C/DOHC
		K050538	SERPENTIN	ALT. & D.H. C/SOHC
		31118	TAPON DE ACEITE	
		31838	TAPON DE GASOLINA	SIN LLAVE REGULAR
		31523	TAPON DE RADIADOR	(16 lbs) Sin Palanca
		T43008	TENSOR ARBOL DE LEVAS	
		33849	TERMOSTATO	195°F
4 CIL, 2.0 L	2005	T265	BANDA ARBOL DE LEVAS	DOHC
		K060490	SERPENTIN	ALT. & A.A. DOHC
		K040353	SERPENTIN	D.H. DOHC
		31118	TAPON DE ACEITE	
		31838	TAPON DE GASOLINA	SIN LLAVE REGULAR
		31525	TAPON DE RADIADOR	(18 lbs) Sin Palanca
		33849	TERMOSTATO	195°F
4 CIL, 2.0 L	2004	T245	BANDA ARBOL DE LEVAS	
		20893	MANGUERA SUP.	
		31118	TAPON DE ACEITE	
		31838	TAPON DE GASOLINA	SIN LLAVE REGULAR
		31528	TAPON DE RADIADOR	(16 lbs) Sin Palanca
		33849	TERMOSTATO	195°F
4 CIL, 2.4 L	2004	T265	BANDA ARBOL DE LEVAS	
		K040353	D.H.	
		92078	EDH	PRESION
		22629	MANGUERA INF.	DOHC
		22357	MANGUERA SUP.	DOHC
		T42121	POLEA BANDA DE TIEMPO	
		T42017	POLEA BANDA DE TIEMPO	
		K050370	SERPENTIN	D.H. C/SOHC
		K060486	SERPENTIN	ALT. & A.A. C/DOHC
		K050538	SERPENTIN	AA & D.H. C/SOHC
		31118	TAPON DE ACEITE	
		31085	TAPON DE ACEITE	
		31836	TAPON DE GASOLINA	CON LLAVE REGULAR
		31838	TAPON DE GASOLINA	SIN LLAVE REGULAR
		31516	TAPON DE RADIADOR	(16 lbs) Con palanca
		31525	TAPON DE RADIADOR	(18 lbs) Sin Palanca
		T41038	TENSOR ARBOL DE LEVAS	
		T43008	TENSOR ARBOL DE LEVAS	
		T41054	TENSOR ARBOL DE LEVAS	
		33849	TERMOSTATO	195°F
4 CIL, 2.4 L	2003	K050538	A.A., D.H.	SOHC











**RAM WAGON 3500**

V-8, 5.9 L	2002	30T 5/8"	CALEF. A "T"-1	C/Calefactor Auxiliar; C/AA
		30T 5/8"	CALEF. A TUBO	S/Calefactor Auxiliar
		30T 5/8"	CALEF. A VALVULA	C/Calefactor Auxiliar; C/AA
		30T 5/8"	CALEF. A VALVULA	S/Calefactor Auxiliar
		22038	MANGUERA DE PASO	
		22396	MANGUERA INF.	
		22482	MANGUERA SUP.	
		38016	POLEA DEL TENSOR	
		K071005	SERPENTIN	C/AA
		K070903	SERPENTIN	S/AA
		30T 5/8"	T-1 A TUBO-1	C/Calefactor Auxiliar; C/AA
		30T 5/8"	T-1 A TUBO-3	C/Calefactor Auxiliar; C/AA
		30T 5/8"	T-2 A MOTOR	C/Calefactor Auxiliar; C/AA
		30T 5/8"	T-2 A TUBO-2	C/Calefactor Auxiliar; C/AA







    				    						
V-6, 2.5 L	1998	31778 31748 31734 31615 31523 31516 T41039 33878	TAPON DE GASOLINA TAPON DE GASOLINA TAPON DE GASOLINA TAPON DE GASOLINA TAPON DE RADIADOR TAPON DE RADIADOR TENSOR ARBOL DE LEVAS THERMOSTATO	CON LLAVE REGULAR SIN LLAVE REGULAR CON LLAVE C/CONT. DE EMIS SIN LLAVE C/CONT. DE EMIS (16 lbs) Sin Palanca (16 lbs) Con palanca	2007	K040390 K040390	SERPENTIN SERPENTIN	D.H. ALTERNADOR		
<b>VIPER</b>										
4 CIL, 2.0 L	1997	T245 352520(803) 352650(803) TCK245 22128 22129 38042 38020 K040355 K060529 31118 31748 31734 31615 31778 31516 31523 T41002 T43001 33849	BANDA ARBOL DE LEVAS EDH EDH KIT DE DISTRIBUCION MANGUERA INF. MANGUERA SUP. POLEA POLEA LOCA SERPENTIN SERPENTIN TAPON DE ACEITE TAPON DE GASOLINA TAPON DE GASOLINA TAPON DE GASOLINA TAPON DE RADIADOR TAPON DE RADIADOR TENSOR ARBOL DE LEVAS TENSOR ARBOL DE LEVAS THERMOSTATO	180°F PRESION PRESION C/ASISTENCIA  D.H. ALT. & A.A.  SIN LLAVE REGULAR CON LLAVE C/CONT. DE EMIS SIN LLAVE C/CONT. DE EMIS CON LLAVE REGULAR (16 lbs) Con palanca (16 lbs) Sin Palanca	V-10, 8.0 L V-10, 8.0 L V-10, 8.0 L V-10, 8.0 L V-10, 8.0 L V-10, 8.0 L	2002 2001 2000 1999 1998	38033 K070776 38350 33578 38033 K070776 38350 33578 38033 K070776 38350 33578 38033 K070776 38350 33578	POLEA SERPENTIN TENSOR MICRO-V THERMOSTATO POLEA SERPENTIN TENSOR MICRO-V THERMOSTATO POLEA SERPENTIN TENSOR MICRO-V THERMOSTATO POLEA SERPENTIN TENSOR MICRO-V THERMOSTATO	S/AA 180°F S/AA 180°F S/AA 180°F S/AA 180°F	
4 CIL, 2.4 L	1997	T265 K040355 352520(803) 352650(803) 22127 22126 38042 T42121 38020 K060529 31118 31615 31734 31778 31748 31523 31516 T43008 T43005 33849 T259 92064 TCK259 22121 CH-110021 38042 T42018 K060557 K040384 31085 31778 31734 31615 31748 31523 31516 T41039 33878	BANDA ARBOL DE LEVAS D.H. EDH EDH MANGUERA INF. MANGUERA SUP. POLEA POLEA BANDA DE TIEMPO POLEA LOCA SERPENTIN TAPON DE ACEITE TAPON DE GASOLINA TAPON DE GASOLINA TAPON DE GASOLINA TAPON DE RADIADOR TAPON DE RADIADOR TENSOR ARBOL DE LEVAS TENSOR ARBOL DE LEVAS THERMOSTATO BANDA ARBOL DE LEVAS EDH KIT DE DISTRIBUCION MANGUERA INF. MANGUERA SUP. POLEA POLEA BANDA DE TIEMPO SERPENTIN SERPENTIN TAPON DE ACEITE TAPON DE GASOLINA TAPON DE GASOLINA TAPON DE GASOLINA TAPON DE RADIADOR TAPON DE RADIADOR TENSOR ARBOL DE LEVAS TENSOR ARBOL DE LEVAS THERMOSTATO	195°F C/AA PRESION PRESION C/ASISTENCIA  ALT. & A.A.  SIN LLAVE C/CONT. DE EMIS CON LLAVE C/CONT. DE EMIS CON LLAVE REGULAR SIN LLAVE REGULAR (16 lbs) Sin Palanca (16 lbs) Con palanca  195°F PRESION C/ASIST. VARIABLE  ALT. & A.A. D.H.  CON LLAVE REGULAR CON LLAVE C/CONT. DE EMIS SIN LLAVE C/CONT. DE EMIS SIN LLAVE REGULAR (16 lbs) Sin Palanca (16 lbs) Con palanca	195°F C/AA PRESION PRESION C/ASISTENCIA  ALT. & A.A.  SIN LLAVE C/CONT. DE EMIS CON LLAVE C/CONT. DE EMIS CON LLAVE REGULAR SIN LLAVE REGULAR (16 lbs) Sin Palanca (16 lbs) Con palanca	3 CIL, 1.0 L 3 CIL, 1.0 L 4 CIL, 1.4 L 4 CIL, 1.4 L 4 CIL, 1.5 L 4 CIL, 1.5 L	2009 2008 2009 2008 2009 2008	K060637 K060637 K050380 K030220 K040320 K040320 K030220 K050380 K050380 K040320 K030245 K030245 K050380 K040320	SERPENTIN SERPENTIN SERPENTIN SERPENTIN SERPENTIN SERPENTIN SERPENTIN SERPENTIN SERPENTIN SERPENTIN SERPENTIN SERPENTIN SERPENTIN SERPENTIN	CON A.A. CON A.A. B.A. D.H. A.A. A.A. D.H. B.A. A.A.
<b>FAW</b>										
<b>F1</b>										
<b>F4</b>										
<b>F5</b>										
<b>FIAT</b>										
<b>BRAVO</b>										
4 CIL, 2.4 L	2010	K040390 K040390	SERPENTIN SERPENTIN	D.H. ALT.						
4 CIL, 2.4 L	2009	K040390 K040390	SERPENTIN SERPENTIN	D.H. ALT.						
4 CIL, 2.4 L	2008	K040390 K040390	SERPENTIN SERPENTIN	D.H. ALTERNADOR						
<b>VAN 1000</b>										
4 CIL, 2.4 L	2010	K040390 K040390	SERPENTIN SERPENTIN	D.H. ALT.						
4 CIL, 2.4 L	2009	K040390 K040390	SERPENTIN SERPENTIN	D.H. ALT.						
4 CIL, 2.4 L	2008	K040390 K040390	SERPENTIN SERPENTIN	D.H. ALTERNADOR						
<b>DUCATO</b>										
4 CIL, 2.3 L DIESEL	2010	4PK903SF T1621 91030 T42163 K070425	A.A. STRECH FIT BANDA ARBOL DE LEVAS HERRAMIENTA INST. STRECH F POLEA DE DISTRIBUCION SERPENTIN						178 D X 30 mm	

4 CIL. 2.3 L DIESEL	2010	RC216 T43163	TAPONES DE RADIADOR TENSOR	20 LBS.
4 CIL. 3.0 L DIESEL	2010	4PK1102SF 91030 K060458 RC216	A.A. STRECH FIT HERRAMIENTA INST. STRECH F SERPENTIN TAPONES DE RADIADOR	
4 CIL. 2.3 L DIESEL	2009	4PK903SF T1621 91030 T42163 K070425 RC216 T43163	A.A. STRECH FIT BANDA ARBOL DE LEVAS HERRAMIENTA INST. STRECH F POLEA DE DISTRIBUCION SERPENTIN TAPONES DE RADIADOR TENSOR	178 D X 30 mm 20 LBS.
4 CIL. 3.0 L DIESEL	2009	4PK1102SF 91030 K060458 RC216	A.A. STRECH FIT HERRAMIENTA INST. STRECH F SERPENTIN TAPONES DE RADIADOR	20 LBS.
4 CIL. 2.3 L DIESEL	2008	4PK903SF T1621 91030 T42163 K070425 RC216 T43163	A.A. STRECH FIT BANDA ARBOL DE LEVAS HERRAMIENTA INST. STRECH F POLEA DE DISTRIBUCION SERPENTIN TAPONES DE RADIADOR TENSOR	178 D X 30 mm 20 LBS.
4 CIL. 3.0 L DIESEL	2008	4PK1102SF 91030 K060458 RC216	A.A. STRECH FIT HERRAMIENTA INST. STRECH F SERPENTIN TAPONES DE RADIADOR	20 LBS.

4 CIL. 1.6 L	2003	T43068 T601 T42061 K040337 K050370 K030267 T43068	TENSOR ARBOL DE LEVAS BANDA ARBOL DE LEVAS POLEA LOCA DISTRIBUCION SERPENTIN SERPENTIN SERPENTIN TENSOR ARBOL DE LEVAS	{158 D x 25 mm} A.A. ALTERNADOR D.H.

**GRANDE PUNTO**

4 CIL. 1.4 L	2010	T1096A K050455 K040262 T43055 T38368	BANDA ARBOL DE LEVAS SERPENTIN SERPENTIN TENSOR TENSOR SERPENTIN	124 D X 22 MM CON A.A. SIN A.A.
4 CIL. 1.4 L	2009	T1096A K050455 K040262 T43055 T38368	BANDA ARBOL DE LEVAS SERPENTIN SERPENTIN TENSOR TENSOR SERPENTIN	124 D X 22 MM CON A.A. SIN A.A.

**PALIO**

4 CIL. 1.8 L	2008	T203 K050690 K050715 TPG-14004 TMV-14001	BANDA ARBOL DE LEVAS SERPENTIN SERPENTIN TENSOR ARBOL DE LEVAS TENSOR MICRO-V	SIN A.A. CON A.A.
4 CIL. 1.8 L	2007	T203 K050690 K050715 TPG-14004 TMV-14001	BANDA ARBOL DE LEVAS SERPENTIN SERPENTIN TENSOR ARBOL DE LEVAS TENSOR MICRO-V	SIN A.A. CON A.A.
4 CIL. 1.6 L	2006	T601 T42061 K050370 K030267 K040337 T43068	BANDA ARBOL DE LEVAS POLEA LOCA DISTRIBUCION SERPENTIN SERPENTIN SERPENTIN TENSOR ARBOL DE LEVAS	ALTERNADOR D.H. A.A.
4 CIL. 1.8 L	2006	T203 K050690 K050715 TPG-14004 TMV-14001	BANDA ARBOL DE LEVAS SERPENTIN SERPENTIN TENSOR ARBOL DE LEVAS TENSOR MICRO-V	SIN A.A. CON A.A.
4 CIL. 1.6 L	2005	T601 T42061 K050370 K030267 K040337 T43068	BANDA ARBOL DE LEVAS POLEA LOCA DISTRIBUCION SERPENTIN SERPENTIN SERPENTIN TENSOR ARBOL DE LEVAS	ALTERNADOR D.H. A.A.
4 CIL. 1.6 L	2004	T601 T42061 K040337 K050370 K030267	BANDA ARBOL DE LEVAS POLEA LOCA DISTRIBUCION SERPENTIN SERPENTIN SERPENTIN	ALTERNADOR D.H. A.A.

**PALIO ADVENTURE**

4 CIL. 1.8 L	2008	T203 K050690 K050715 TPG-14004 TMV-14001	BANDA ARBOL DE LEVAS SERPENTIN SERPENTIN TENSOR ARBOL DE LEVAS TENSOR MICRO-V	SIN A.A. CON A.A.
4 CIL. 1.8 L	2007	T203 K050715 K050690 TPG-14004 TMV-14001	BANDA ARBOL DE LEVAS SERPENTIN SERPENTIN TENSOR ARBOL DE LEVAS TENSOR MICRO-V	CON A.A. SIN A.A.
4 CIL. 1.6 L	2006	T601 T42061 K030267 K050370 K040337 T43068	BANDA ARBOL DE LEVAS POLEA LOCA DISTRIBUCION SERPENTIN SERPENTIN SERPENTIN TENSOR ARBOL DE LEVAS	D.H. ALTERNADOR A.A.
4 CIL. 1.8 L	2006	T203 K050690 K050715 TPG-14004 TMV-14001	BANDA ARBOL DE LEVAS SERPENTIN SERPENTIN TENSOR ARBOL DE LEVAS TENSOR MICRO-V	SIN A.A. CON A.A.
4 CIL. 1.6 L	2005	T601 T42061 K040337 K050370 K030267 T43068	BANDA ARBOL DE LEVAS POLEA LOCA DISTRIBUCION SERPENTIN SERPENTIN SERPENTIN TENSOR ARBOL DE LEVAS	A.A. ALTERNADOR D.H.
4 CIL. 1.6 L	2004	T601 T42061 K050370 K030267 K040337 T43068	BANDA ARBOL DE LEVAS POLEA LOCA DISTRIBUCION SERPENTIN SERPENTIN SERPENTIN TENSOR ARBOL DE LEVAS	ALTERNADOR D.H. A.A.
4 CIL. 1.6 L	2003	T601 T42061 K050370 K030267 K040337 T43068	BANDA ARBOL DE LEVAS POLEA LOCA DISTRIBUCION SERPENTIN SERPENTIN SERPENTIN TENSOR ARBOL DE LEVAS	ALTERNADOR D.H. A.A.











**PANDA**

4 CIL. 1.2 L	2010	T1637 K050455 K040262	BANDA ARBOL DE LEVAS SERPENTIN SERPENTIN	129 D X 22 MM CON A.A. SIN A.A.
4 CIL. 1.2 L	2009	T1637 K040262 K050455	BANDA ARBOL DE LEVAS SERPENTIN SERPENTIN	129 D X 22 MM SIN A.A. CON A.A.
4 CIL. 1.2 L	2008	T1637 K040262 K050455	BANDA ARBOL DE LEVAS SERPENTIN SERPENTIN	129 D X 22 MM S/AA CON A.A.

**FORD**

**AEROSTAR**











V-6, 3.0 L	1997	366290(916) 22255 22284 38002 38006 38015 K061066 K060806	EDH MANG. INF. MANG. SUP. POLEA POLEA DEL TENSOR POLEA LOCA SERPENTIN SERPENTIN	PRESION C/AA S/AA
------------	------	--	--	-------------------------

    				    					
V-6, 3.0 L	1997	31109 31615 31518 31528 38114 33009 33509	TAPON DE ACEITE TAPON DE GASOLINA TAPON DE RADIADOR TAPON DE RADIADOR TENSOR MICRO-V TERMOSTATO TERMOSTATO	SIN LLAVE C/CONT. DE EMIS (16 lbs) Con Palanca (16 lbs) Sin Palanca  195°F 195°F	V-6, 2.5 L	1999	31783 31530 31539 T43003 38188 33339	TAPON DE GASOLINA TAPON DE RADIADOR TAPON DE RADIADOR TENSOR ARBOL DE LEVAS TENSOR MICRO-V TERMOSTATO	CON LLAVE REGULAR (18 lbs) Sin Palanca (15 lbs) Con Palanca  195°F
V-6, 4.0 L	1997	360110(718) 38008 38001 K060864 31109 31615 31528 31518 38102 33779	EDH POLEA DEL TENSOR POLEA LOCA SERPENTIN TAPON DE ACEITE TAPON DE GASOLINA TAPON DE RADIADOR TAPON DE RADIADOR TENSOR MICRO-V TERMOSTATO	PREISION  C/AA  SIN LLAVE C/CONT. DE EMIS (16 lbs) Sin Palanca (16 lbs) Con Palanca  195°F			BDH-6312 19105 91969 22304 22240 22180 38006 38001 K060721 K060623 K030267 31109 31100 31637 31783 31530 31539 38276 38250 33248	BOMBA DE DIR. HIDR. CALEF. A MULTIPLE EDH MANGUERA INF. MANGUERA INF. MANGUERA SUP. POLEA DEL TENSOR POLEA LOCA SERPENTIN SERPENTIN SERPENTIN B.A. TAPON DE ACEITE TAPON DE ACEITE TAPON DE GASOLINA TAPON DE GASOLINA TAPON DE RADIADOR TAPON DE RADIADOR TENSOR MICRO-V TENSOR MICRO-V TERMOSTATO	PREISION C/ASIST. VARIABLE         C/AA S/AA S/AA











## CONTOUR











4 CIL, 2.0 L	2000	T294 19060 TCK294A 22366 22367 22239 38008 T42036 T42034 38018 K060802 K060827 31117 31637 31783 31539 31530 T43003 38188 33339	BANDA ARBOL DE LEVAS CALEF. A TUBO-1 KIT DE DISTRIBUCION MANGUERA INF. MANGUERA INF. MANGUERA SUP. POLEA POLEA BANDA DE TIEMPO POLEA BANDA DE TIEMPO POLEA LOCA SERPENTIN SERPENTIN TAPON DE ACEITE TAPON DE GASOLINA TAPON DE GASOLINA TAPON DE RADIADOR TAPON DE RADIADOR TENSOR ARBOL DE LEVAS TENSOR MICRO-V TERMOSTATO	{129 D x 25.4 mm}  29-Mar-99 hasta 2003 T42036 AUTOMATICO MANUAL AUTOMATICO / MANUAL  SUPERIOR INFERIOR Mar. 98 Y POST. S/AA C/AA  SIN LLAVE REGULAR CON LLAVE REGULAR (15 lbs) Con Palanca (18 lbs) Sin Palanca  195°F	4 CIL, 2.0 L	1998	T294 BDH-6311 91968 TCK294 22367 22366 22239 38008 T42034 T42035 38006 38018 K060802 K060858 K060832 K060832 31117 31637 31530 31539 T43003 38188 33339	BANDA ARBOL DE LEVAS BOMBA DE DIR. HIDR. EDH KIT DE DISTRIBUCION MANGUERA INF. MANGUERA INF. MANGUERA SUP. POLEA POLEA BANDA DE TIEMPO POLEA BANDA DE TIEMPO POLEA LOCA POLEA LOCA POLEA LOCA SERPENTIN SERPENTIN SERPENTIN TAPON DE ACEITE TAPON DE GASOLINA TAPON DE RADIADOR TAPON DE RADIADOR TENSOR ARBOL DE LEVAS TENSOR MICRO-V TERMOSTATO	PREISION Ene 1998 hasta 28-Mar-99 T4; MANUAL AUTOMATICO AUTOMATICO / MANUAL  INFERIOR SUPERIOR Feb. 98 Y ANT. Mar. 98 Y POST. S/AA C/AA C/AA C/AA  SIN LLAVE REGULAR (18 lbs) Sin Palanca (15 lbs) Con Palanca  195°F
V-6, 2.5 L	2000	BDH-6312 19105 91969 22240 22180 38006 38001 K060623 K060721 K030267 31109 31100 31637 31783 31539 31530 38250 38276 33248	BOMBA DE DIR. HIDR. CALEF. A MULTIPLE EDH MANGUERA INF. MANGUERA SUP. POLEA DEL TENSOR POLEA LOCA SERPENTIN SERPENTIN SERPENTIN B.A. TAPON DE ACEITE TAPON DE ACEITE TAPON DE GASOLINA TAPON DE GASOLINA TAPON DE RADIADOR TAPON DE RADIADOR TENSOR MICRO-V TENSOR MICRO-V TERMOSTATO	PREISION C/ASISTENCIA       S/AA C/AA S/AA	V-6, 2.5 L	1998	BDH-6312 91969 22240 22304 22180 38006 38001 K060623 K060721 K030267 31109 31100 31637 31530 31539 38250 38276 33248	BOMBA DE DIR. HIDR. EDH MANGUERA INF. MANGUERA INF. MANGUERA SUP. POLEA DEL TENSOR POLEA LOCA SERPENTIN SERPENTIN SERPENTIN B.A. TAPON DE ACEITE TAPON DE ACEITE TAPON DE GASOLINA TAPON DE RADIADOR TAPON DE RADIADOR TENSOR MICRO-V TENSOR MICRO-V TERMOSTATO	PREISION C/ASIST. VARIABLE         S/AA C/AA S/AA
4 CIL, 2.0 L	1999	T294 19060 TCK294A TCK294 22366 22367 22239 38008 T42035 T42034 T42036 38018 K060802 K060827 31117 31637	BANDA ARBOL DE LEVAS CALEF. A TUBO-1 KIT DE DISTRIBUCION KIT DE DISTRIBUCION MANGUERA INF. MANGUERA INF. MANGUERA SUP. POLEA POLEA BANDA DE TIEMPO POLEA BANDA DE TIEMPO POLEA BANDA DE TIEMPO POLEA LOCA SERPENTIN SERPENTIN TAPON DE ACEITE TAPON DE GASOLINA	{129 D x 25.4 mm}  29-Mar-99 hasta 2003 T42036 Ene 1998 hasta 28-Mar-99 T4; AUTOMATICO MANUAL AUTOMATICO / MANUAL  SUPERIOR INFERIOR SUPERIOR Mar. 98 Y POST. S/AA C/AA  SIN LLAVE REGULAR	4 CIL, 2.0 L	1997	T258 BDH-6311 91837 TCK250 TCK258 CH-130052 22178 22179	BANDA ARBOL DE LEVAS BOMBA DE DIR. HIDR. EDH KIT DE DISTRIBUCION KIT DE DISTRIBUCION MANGUERA INF. MANGUERA INF. MANGUERA INF.	PREISION       MANUAL AUTOMATICO



    				    					
4 CIL, 2.0 L	1997	22239	MANGUERA SUP.	AUTOMATICO / MANUAL	V-8, 4.6 L	2003	38006	POLEA TENSORA	SIN LLAVE REGULAR (16 lbs) Sin Palanca
		38001	POLEA	DERECHA			38006	SERPENTIN	
		T42033	POLEA BANDA DE TIEMPO	IZQUIERDA			31275	TAPON DE ACEITE	
		T42032	POLEA BANDA DE TIEMPO	S/AA			31830	TAPON DE GASOLINA	
		K060682	SERPENTIN	C/AA			31406	TAPON DE RADIADOR	
		K060733	SERPENTIN	(18 lbs) Sin Palanca			38189	SENSOR MICRO-V	
		31117	TAPON DE ACEITE	195°F			33469	TERMOSTATO	
		31530	TAPON DE RADIADOR	PRESION			92100	EDH	
		T41008	TENSOR ARBOL DE LEVAS				38006	POLEA TENSORA	
		38160	SENSOR MICRO-V				K060908	SERPENTIN	
		33339	TERMOSTATO				31275	TAPON DE ACEITE	
							31830	TAPON DE GASOLINA	
		V-6, 2.5 L	1997	BDH-6312			BOMBA DE DIR. HIDR.		
91838	EDH				38189	SENSOR MICRO-V			
22304	MANGUERA INF.				33469	TERMOSTATO			
22240	MANGUERA INF.				361330(802)	EDH			
22180	MANGUERA SUP.				22388	MANG. INF.			
38006	POLEA DEL TENSOR				22392	MANG. SUP.			
38001	POLEA LOCA				K060915	SERPENTIN			
K060716	SERPENTIN			C/AA	31109	TAPON DE ACEITE			
K060623	SERPENTIN			S/AA	31828	TAPON DE GASOLINA			
K030267	SERPENTIN B.A.			C/AA	31830	TAPON DE GASOLINA			
31109	TAPON DE ACEITE				31406	TAPON DE RADIADOR			
31100	TAPON DE ACEITE				38189	SENSOR MICRO-V			
31530	TAPON DE RADIADOR			(18 lbs) Sin Palanca	33189	TERMOSTATO			
38250	TENSOR MICRO-V	SERPENTIN	361330(802)	EDH					
38276	TENSOR MICRO-V	B. AGUA	22388	MANG. INF.					
33248	TERMOSTATO	195°F	22392	MANG. SUP.					
<b>COURIER</b>									
4 CIL, 1.6 L	2008	CH-130292	MANGUERA INF.		V-8, 4.6 L	2000	31109	TAPON DE ACEITE	CON LLAVE REGULAR SIN LLAVE REGULAR (16 lbs) Sin Palanca
		CH-130281	MANGUERA SUP.	CON AA Y CON DH			31828	TAPON DE GASOLINA	
		K060882	SERPENTIN	SIN AA Y SIN DH			31830	TAPON DE GASOLINA	
		K060413	SERPENTIN	CON AA Y SIN DH			31406	TAPON DE RADIADOR	
		K060856	SERPENTIN	CON AA Y SIN DH			38189	SENSOR MICRO-V	
		K060670	SERPENTIN	SIN AA Y CON DH			33189	TERMOSTATO	
4 CIL, 1.6 L	2007	CH-130292	MANGUERA INF.		V-8, 4.6 L	1999	361330(802)	EDH	CON LLAVE REGULAR SIN LLAVE REGULAR (16 lbs) Sin Palanca
		CH-130281	MANGUERA SUP.	180°F			22388	MANGUERA INF.	
		K060413	SERPENTIN	SIN AA Y SIN DH			22392	MANGUERA SUP.	
		K060882	SERPENTIN	CON AA Y CON DH			K060915	SERPENTIN	
		K060670	SERPENTIN	SIN AA Y CON DH			31109	TAPON DE ACEITE	
		K060856	SERPENTIN	CON AA Y SIN DH			31828	TAPON DE GASOLINA	
4 CIL, 1.6 L	2006	CH-130292	MANG. INF.		V-8, 4.6 L	1999	31406	TAPON DE RADIADOR	CON LLAVE REGULAR SIN LLAVE REGULAR (16 lbs) Sin Palanca
		CH-130281	MANG. SUP.	180°F			33189	TERMOSTATO	
		K060413	SERPENTIN	S/AA, S/DH			19764	CALEF. A MULTIPLE	
		K060882	SERPENTIN	C/AA, C/DH			18070	CALEF. A TUBO-1	
		K060670	SERPENTIN	S/AA, C/DH			361330(802)	EDH	
		K060856	SERPENTIN	S/AA, S/DH			22388	MANGUERA INF.	
4 CIL, 1.6 L	2005	CH-130292	MANG. INF.		V-8, 4.6 L	1998	22392	MANGUERA SUP.	SIN LLAVE REGULAR CON LLAVE REGULAR (16 lbs) Sin Palanca
		CH-130281	MANG. SUP.	180°F			K060975	SERPENTIN	
		K060882	SERPENTIN	C/AA, C/DH			31109	TAPON DE ACEITE	
		K060413	SERPENTIN	S/AA, S/DH			31830	TAPON DE GASOLINA	
		K060856	SERPENTIN	C/AA, S/DH			31828	TAPON DE GASOLINA	
		K060670	SERPENTIN	S/AA, C/DH			31406	TAPON DE RADIADOR	
4 CIL, 1.6 L	2004	CH-130292	MANGUERA INF.		V-8, 4.6 L	1997	38132	TENSOR MICRO-V	SIN LLAVE REGULAR CON LLAVE REGULAR (16 lbs) Sin Palanca
		CH-130281	MANGUERA SUP.	180°F			33189	TERMOSTATO	
		K060670	SERPENTIN	S/AA, C/DH			361330(802)	EDH	
		K060413	SERPENTIN	S/AA, S/DH			22388	MANGUERA INF.	
		K060882	SERPENTIN	C/AA, C/DH			22392	MANGUERA SUP.	
		K060856	SERPENTIN	C/AA, S/DH			K060975	SERPENTIN	
4 CIL, 1.6 L	2003	CH-130292	MANGUERA INF.		V-8, 4.6 L	2010	31109	TAPON DE ACEITE	SIN LLAVE REGULAR (16 lbs) Sin Palanca
		CH-130281	MANGUERA SUP.	180°F			80233	EDH	
		K060856	SERPENTIN	C/AA, S/DH			21927	MANGUERA INF.	
		K060882	SERPENTIN	C/AA, C/DH			22393	MANGUERA SUP.	
		K060670	SERPENTIN	S/AA, C/DH			K060975	SERPENTIN	
		K060413	SERPENTIN	S/AA, S/DH			31109	TAPON DE ACEITE	
4 CIL, 1.6 L	2004	92100	EDH		V-8, 4.6 L	2010	31830	TAPON DE GASOLINA	SIN LLAVE REGULAR (16 lbs) Sin Palanca
							31406	TAPON DE RADIADOR	
							33189	TERMOSTATO	
							22372	MANGUERA INF.	
							22316	MANGUERA SUP.	
							38001	POLEA	
<b>E SERIES VAN</b>									
<b>CROWN VICTORIA</b>									
V-8, 4.6 L	2004	92100	EDH						



    		    							
V-8, 4.6 L	2004	38006 K060990 K060806 31109 31841 31406 38274 38329 33469	POLEA TENSORA SERPENTIN SERPENTIN TAPON DE ACEITE TAPON DE GASOLINA TAPON DE RADIADOR TENSOR MICRO-V TENSOR MICRO-V TERMOSTATO	C/AA C/AA S/AA  SIN LLAVE REGULAR (16 lbs) Sin Palanca C/AA S/AA 195°F	V-6, 4.2 L	2001	K060990 K060806 31109 31841 31406 38133 38274 38329 33469	SERPENTIN SERPENTIN TAPON DE ACEITE TAPON DE GASOLINA TAPON DE RADIADOR TENSOR MICRO-V TENSOR MICRO-V TENSOR MICRO-V TERMOSTATO	C/AA S/AA  SIN LLAVE REGULAR (16 lbs) Sin Palanca C/AA S/AA 195°F
V-8, 5.4 L	2004	38001 38006 K060990 31275 31842 31406 38329 38274	POLEA POLEA SERPENTIN TAPON DE ACEITE TAPON DE GASOLINA TAPON DE RADIADOR TENSOR MICRO-V TENSOR MICRO-V	C/AA  C/AA  CON LLAVE REGULAR (16 lbs) Sin Palanca	V-6, 4.2 L	2001	19286 91965 22317 22314 19025 38009 38007 38001 K060970 K061025	CALEF. A MULTIPLE EDH MANGUERA INF. MANGUERA SUP. PASO POLEA POLEA DEL TENSOR POLEA LOCA LISA SERPENTIN SERPENTIN	S/Calef. Auxiliar; Re-usar el res PRESION      C/AA S/AA C/AA
V-6, 4.2 L	2003	19286 22314 19025 38009 38007 38001 K060970 K061025 31109 31830 31406 38138 33469	CALEF. A MULTIPLE MANGUERA SUP. PASO POLEA POLEA DEL TENSOR POLEA LOCA LISA SERPENTIN SERPENTIN TAPON DE ACEITE TAPON DE GASOLINA TAPON DE RADIADOR TENSOR MICRO-V TERMOSTATO	S/Calef. Auxiliar; Re-usar el res    C/AA S/AA C/AA  SIN LLAVE REGULAR (16 lbs) Sin Palanca 195°F	V-8, 4.6 L	2001	22372 22315 38022 38023 38053 K080991 K080806 38133 38330	MANGUERA INF. MANGUERA SUP. POLEA POLEA POLEA SERPENTIN SERPENTIN TENSOR MICRO-V TENSOR MICRO-V	C/AA S/AA C/AA   C/AA S/AA C/AA
V-8, 4.6 L	2003	38001 38329 38274	POLEA TENSOR MICRO-V TENSOR MICRO-V	195°F	V-8, 5.4 L	2001	19191 91966 22318 22315 38023 38022 38053	CALEF. A TUBO-1 EDH MANGUERA INF. MANGUERA SUP. POLEA POLEA POLEA	S/Calef. Auxiliar PRESION C/AA, C/DH C/AA
V-8, 5.4 L	2003	K060990 K060806 31109 31830 31406 38274 38329 33469	SERPENTIN SERPENTIN TAPON DE ACEITE TAPON DE GASOLINA TAPON DE RADIADOR TENSOR MICRO-V TENSOR MICRO-V TERMOSTATO	C/AA S/AA  SIN LLAVE REGULAR (16 lbs) Sin Palanca 195°F	V-8, 7.3 L	2001	22319 22312	MANGUERA INF. MANGUERA SUP.	C/AA, C/DH C/AA, C/DH
V-6, 4.2 L	2002	19286 91965 22314 19025 38001 38009 38007 K061025 K060970 31109 31830 31406 38138 33469	CALEF. A MULTIPLE EDH MANGUERA SUP. PASO POLEA POLEA DEL TENSOR SERPENTIN SERPENTIN TAPON DE ACEITE TAPON DE GASOLINA TAPON DE RADIADOR TENSOR MICRO-V TERMOSTATO	S/Calef. Auxiliar; Re-usar el res PRESION  LISO  C/AA S/AA  SIN LLAVE REGULAR (16 lbs) Sin Palanca 195°F	V-6, 4.2 L	2000	19115 22471 91965 22317 22314 19025 38009	CALEF. A MULTIPLE CALEF. A MULTIPLE EDH MANGUERA INF. MANGUERA SUP. PASO POLEA	S/Calef. Auxiliar C/Calef. Auxiliar PRESION
V-8, 4.6 L	2002	91966 22372 22315 38001 K060990 K060806 31109 31841 31406 38329 38274 33469	EDH MANGUERA INF. MANGUERA SUP. POLEA SERPENTIN SERPENTIN TAPON DE ACEITE TAPON DE GASOLINA TAPON DE RADIADOR TENSOR MICRO-V TENSOR MICRO-V TERMOSTATO	PRESION   C/AA S/AA  SIN LLAVE REGULAR (16 lbs) Sin Palanca 195°F	V-8, 4.6 L	2000	22470 22372 22315 38022 38053 38023 K080806 K080991	TUBO-2 A CALEF. MANGUERA INF. MANGUERA SUP. POLEA POLEA POLEA SERPENTIN SERPENTIN	C/AA C/AA S/AA  SIN LLAVE REGULAR (16 lbs) Sin Palanca 195°F C/Calef. Auxiliar
V-8, 5.4 L	2002	19191 91966 22315 38001 38023 38022	CALEF. A TUBO-1 EDH MANGUERA SUP. POLEA POLEA DEL TENSOR POLEA LOCA	S/Calef. Auxiliar PRESION   C/AA S/AA	V-8, 4.6 L	2000	38133	TENSOR MICRO-V	C/AA

    				    				
V-8, 4.6 L	2000	38330	TENSOR MICRO-V		V-8, 7.3 L	22319	MANGUERA INF.	C/AA, C/DH
V-8, 5.4 L	2000	19191	CALEF. A TUBO-1	S/Calef. Auxiliar		22312	MANGUERA SUP.	C/AA, C/DH
		22318	MANGUERA INF.	C/AA, C/DH		38028	POLEA	LISO
		22315	MANGUERA SUP.	C/AA, C/DH		38053	POLEA	CON CANALES
		38023	POLEA		V-10, 6.8 L	1997	38023	POLEA
		38022	POLEA			38022	POLEA	
		38053	POLEA			38133	TENSOR MICRO-V	
		K080806	SERPENTIN	S/AA		38330	TENSOR MICRO-V	
		K080991	SERPENTIN	C/AA	V-6, 4.2 L	1997	22317	MANGUERA INF.
		38133	TENSOR MICRO-V	C/AA		22314	MANGUERA SUP.	
V-8, 7.3 L	2000	38330	TENSOR MICRO-V			38001	POLEA	LISO
		22319	MANGUERA INF.	C/AA, C/DH		38009	POLEA	
		22312	MANGUERA SUP.	C/AA, C/DH		38007	POLEA	
V-6, 4.2 L	1999	19115	CALEF. A MULTIPLE	S/Calef. Auxiliar		K060970	SERPENTIN	S/AA
		22471	CALEF. A MULTIPLE	C/Calef. Auxiliar		K061025	SERPENTIN	C/AA
		22317	MANGUERA INF.			38138	TENSOR MICRO-V	
		22314	MANGUERA SUP.		V-8, 5.4 L	1997	22318	MANGUERA INF.
		19025	PASO			22315	MANGUERA SUP.	C/AA, C/DH
		38009	POLEA			38022	POLEA	C/AA, C/DH
		38007	POLEA DEL TENSOR			38023	POLEA	
		38001	POLEA LOCA LISA	C/AA		38053	POLEA	
		K061025	SERPENTIN	C/AA		K080991	SERPENTIN	C/AA
		K060970	SERPENTIN	S/AA		K080806	SERPENTIN	S/AA
		38138	TENSOR MICRO-V			38133	TENSOR MICRO-V	
V-8, 4.6 L	1999	22470	TUBO-2 A CALEF.	C/Calef. Auxiliar	V-8, 7.3 L	1997	22319	MANGUERA INF.
		91966	EDH	PRESION		22312	MANGUERA SUP.	C/AA, C/DH
		22372	MANGUERA INF.			38052	POLEA	C/AA, C/DH
		22315	MANGUERA SUP.			38022	POLEA	
		38022	POLEA			38119	TENSOR MICRO-V	
		38053	POLEA					
		38023	POLEA					
		K080991	SERPENTIN	C/AA				
		K080806	SERPENTIN	S/AA				
		31109	TAPON DE ACEITE					
		31830	TAPON DE GASOLINA	SIN LLAVE REGULAR				
		31406	TAPON DE RADIADOR	(16 lbs) Sin Palanca				
		38133	TENSOR MICRO-V	C/AA				
		38330	TENSOR MICRO-V					
		33469	TERMOSTATO	195°F	4 CIL, 2.0 L	2009	CH-130272	MANGUERA INF.
V-8, 5.4 L	1999	19192	CALEF. A MULTIPLE	S/Calef. Auxiliar; Re-usar el res		CH-130261	MANGUERA SUP.	
		19191	CALEF. A TUBO-1	S/Calef. Auxiliar		38006	POLEA	
		22318	MANGUERA INF.	C/AA, C/DH		K060878	SERPENTIN	
		22316	MANGUERA SUP.			38204	TENSOR	
		22315	MANGUERA SUP.	C/AA, C/DH	4 CIL, 2.0 L	2008	CH-130272	MANGUERA INF.
		38023	POLEA			CH-130261	MANGUERA SUP.	
		38022	POLEA			38006	POLEA	
		38053	POLEA			K060878	SERPENTIN	
		K080806	SERPENTIN	S/AA		38204	TENSOR	
		K080991	SERPENTIN	C/AA	4 CIL, 2.0 L	2007	CH-130272	MANG. INF.
		38133	TENSOR MICRO-V	C/AA		CH-130261	MANG. SUP.	
		38330	TENSOR MICRO-V	C/AA		38006	POLEA LOCA	
V-8, 7.3 L	1999	22319	MANGUERA INF.	C/AA, C/DH		K060878	SERPENTIN	
		22312	MANGUERA SUP.	C/AA, C/DH	4 CIL, 2.0 L	2006	CH-130272	MANG. INF.
V-10, 6.8 L	1998	38053	POLEA			CH-130261	MANG. SUP.	
		38023	POLEA	LISO		38006	POLEA LOCA	
		38022	POLEA			38204	TENSOR	
		38133	TENSOR MICRO-V			K060878	SERPENTIN	
		38330	TENSOR MICRO-V			38204	TENSOR	
V-6, 4.2 L	1998	22317	MANGUERA INF.		4 CIL, 2.0 L	2005	CH-130272	MANGUERA INF.
		22314	MANGUERA SUP.			CH-130261	MANGUERA SUP.	
		38009	POLEA			38006	POLEA LOCA	
		38007	POLEA	LISO		K060878	SERPENTIN	
		38001	POLEA			38204	TENSOR	
		K061025	SERPENTIN	C/AA	4 CIL, 2.0 L	2004	CH-130272	MANGUERA INF.
		K060970	SERPENTIN	S/AA		CH-130261	MANGUERA SUP.	
		38138	TENSOR MICRO-V			38006	POLEA LOCA	
V-8, 5.4 L	1998	22318	MANGUERA INF.	C/AA, C/DH		K060878	SERPENTIN	
		22315	MANGUERA SUP.	C/AA, C/DH	4 CIL, 2.0 L	2003	CH-130272	MANGUERA INF.
		38023	POLEA			CH-130261	MANGUERA SUP.	
		38022	POLEA			K060878	SERPENTIN	
		38053	POLEA			38204	TENSOR	
		K080806	SERPENTIN	S/AA				
		K080991	SERPENTIN	C/AA				
		38133	TENSOR MICRO-V					
		38330	TENSOR MICRO-V					

**ECOSPORT**

4 CIL, 2.0 L	2010	CH-130272	MANGUERA INF.	
		CH-130261	MANGUERA SUP.	
		38006	POLEA	
		K060878	SERPENTIN	
		38204	TENSOR	
4 CIL, 2.0 L	2009	CH-130272	MANGUERA INF.	
		CH-130261	MANGUERA SUP.	
		38006	POLEA	
		K060878	SERPENTIN	
		38204	TENSOR	
4 CIL, 2.0 L	2008	CH-130272	MANGUERA INF.	
		CH-130261	MANGUERA SUP.	
		38006	POLEA	
		K060878	SERPENTIN	
		38204	TENSOR	
4 CIL, 2.0 L	2007	CH-130272	MANG. INF.	
		CH-130261	MANG. SUP.	
		38006	POLEA LOCA	
		K060878	SERPENTIN	
		38204	TENSOR	
4 CIL, 2.0 L	2006	CH-130272	MANG. INF.	
		CH-130261	MANG. SUP.	
		38006	POLEA LOCA	
		K060878	SERPENTIN	
		38204	TENSOR	
4 CIL, 2.0 L	2005	CH-130272	MANGUERA INF.	
		CH-130261	MANGUERA SUP.	
		38006	POLEA LOCA	
		K060878	SERPENTIN	
		38204	TENSOR	
4 CIL, 2.0 L	2004	CH-130272	MANGUERA INF.	
		CH-130261	MANGUERA SUP.	
		38006	POLEA LOCA	
		K060878	SERPENTIN	
		38204	TENSOR	
4 CIL, 2.0 L	2003	CH-130272	MANGUERA INF.	
		CH-130261	MANGUERA SUP.	
		K060878	SERPENTIN	
		38204	TENSOR	











**EDGE**

V-6, 3.5 L	2010	K040352SF	A.A. STRECH FIT	
------------	------	-----------	-----------------	--















V-6, 3.0 L	2003	31828	TAPON DE GASOLINA	CON LLAVE REGULAR		T42034	POLEA BANDA DE TIEMPO	INFERIOR
		38186	SENSOR MICRO-V	ACCESORIO		38001	POLEA LOCA	
		38276	SENSOR MICRO-V	B. AGUA		38006	POLEA TENSORA	DOHC
4 CIL, 2.0 L	2002	T294	BANDA ARBOL DE LEVAS	{129 D x 25.4 mm}		K060507	SERPENTIN	C/AA
		TCK294B	KIT DE DISTRIBUCION	TENSOR T43003		K060468	SERPENTIN	S/AA
		T42036	POLEA BANDA DE TIEMPO	SUPERIOR		31117	TAPON DE ACEITE	
		T42034	POLEA BANDA DE TIEMPO	INFERIOR		31830	TAPON DE GASOLINA	SIN LLAVE REGULAR
		38008	POLEA DEL TENSOR			31828	TAPON DE GASOLINA	CON LLAVE REGULAR
		38018	POLEA LOCA			31536	TAPON DE RADIADOR	(20 lbs) Con Palanca
		K060775	SERPENTIN	S/AA		T43003	TENSOR ARBOL DE LEVAS	
		K060827	SERPENTIN	C/AA		T43004	TENSOR ARBOL DE LEVAS	
		31109	TAPON DE ACEITE			38162	TENSOR MICRO-V	
		31828	TAPON DE GASOLINA	CON LLAVE REGULAR		38171	TENSOR MICRO-V	
		31830	TAPON DE GASOLINA	SIN LLAVE REGULAR		33299	TERMOSTATO	195°F
		31539	TAPON DE RADIADOR	(15 lbs) Con Palanca	4 CIL, 2.0 L	T294	BANDA ARBOL DE LEVAS	{129 D x 25.4 mm}
		T43003	TENSOR ARBOL DE LEVAS			T283	BANDA ARBOL DE LEVAS	
		38188	SENSOR MICRO-V			22399	CALEF. A B.A.	
		33339	TERMOSTATO	195°F		22398	CALEF. A TERMOSTATO	
V-6, 3.0 L	2002	22571	B.A., MULTIPLE			354020(802)	EDH	PRESION
		24026	MANGUERA DE PASO			TCK283	KIT DE DISTRIBUCION	SOHC
		22567	MANGUERA INF.			TCK294A	KIT DE DISTRIBUCION	10-Feb-99 hasta 2003 T42036
		22569	MANGUERA SUP.			28466	MANGUERA DE PASO	
		38006	POLEA	ACCESORIO		21922	MANGUERA INF.	
		K060820	SERPENTIN	C/AA		22346	MANGUERA INF.	
		K030267	SERPENTIN B.A.			CH-130041	MANGUERA SUP.	
		35B 3/8"	TANQUE DE RECUP. A RADIAD	C/ manguera de dia. 3/8"		21514	MANGUERA SUP.	
		31275	TAPON DE ACEITE			22347	MANGUERA SUP.	
		31830	TAPON DE GASOLINA	SIN LLAVE REGULAR		T42034	POLEA BANDA DE TIEMPO	INFERIOR
		31828	TAPON DE GASOLINA	CON LLAVE REGULAR		T42036	POLEA BANDA DE TIEMPO	SUPERIOR
		31539	TAPON DE RADIADOR	(15 lbs) Con Palanca		38001	POLEA DEL TENSOR	
		38186	TENSOR MICRO-V	ACCESORIO		38006	POLEA LOCA	C/AA
		38276	TENSOR MICRO-V	B. AGUA		K060854	SERPENTIN	C/AA
		33248	TERMOSTATO	195°F		K060468	SERPENTIN	S/AA
4 CIL, 2.0 L	2001	T294	BANDA ARBOL DE LEVAS	{129 D x 25.4 mm}		K060507	SERPENTIN	C/AA
		TCK294B	KIT DE DISTRIBUCION	TENSOR T43003		31275	TAPON DE ACEITE	
		22568	MANGUERA SUP.			31828	TAPON DE GASOLINA	CON LLAVE REGULAR
		T42034	POLEA BANDA DE TIEMPO	INFERIOR		31830	TAPON DE GASOLINA	SIN LLAVE REGULAR
		T42036	POLEA BANDA DE TIEMPO	SUPERIOR		31536	TAPON DE RADIADOR	(20 lbs) Con Palanca
		38008	POLEA DEL TENSOR			T43004	TENSOR ARBOL DE LEVAS	
		38018	POLEA LOCA			T43003	TENSOR ARBOL DE LEVAS	
		K060827	SERPENTIN	C/AA		38162	TENSOR MICRO-V	DOHC
		K060775	SERPENTIN	S/AA		38171	TENSOR MICRO-V	
		31117	TAPON DE ACEITE			33299	TERMOSTATO	195°F
		31830	TAPON DE GASOLINA	SIN LLAVE REGULAR	4 CIL, 2.0 L	T283	BANDA ARBOL DE LEVAS	
		31828	TAPON DE GASOLINA	CON LLAVE REGULAR		T294	BANDA ARBOL DE LEVAS	DOHC
		31539	TAPON DE RADIADOR	(15 lbs) Con Palanca		22399	CALEF. A BA	SOHC
		T43003	TENSOR ARBOL DE LEVAS			19058	CALEF. A TERMOSTATO	DOHC
		38188	TENSOR MICRO-V			22398	CALEF. A TERMOSTATO	SOHC
		33339	TERMOSTATO	195°F		18951	CALEF. A TUBO-1	DOHC
V-6, 3.0 L	2001	22567	MANGUERA INF.			354020(802)	EDH	PRESION
		22569	MANGUERA SUP.			TCK294	KIT DE DISTRIBUCION	Ene 1998 hasta 9-Feb-99 T420
		38006	POLEA	ACCESORIO		TCK294A	KIT DE DISTRIBUCION	10-Feb-99 hasta 2003 T42036
		K060820	SERPENTIN	C/AA		TCK283	KIT DE DISTRIBUCION	SOHC
		K030267	SERPENTIN B.A.	C/Banda de 27"		28466	MANGUERA DE PASO	
		K030250	SERPENTIN B.A.	C/Banda de 25 1/2"		22346	MANGUERA INF.	DOHC
		31275	TAPON DE ACEITE			21922	MANGUERA INF.	SOHC
		31830	TAPON DE GASOLINA	SIN LLAVE REGULAR		CH-130041	MANGUERA SUP.	
		31828	TAPON DE GASOLINA	CON LLAVE REGULAR		21514	MANGUERA SUP.	SOHC
		31539	TAPON DE RADIADOR	(15 lbs) Con Palanca		22347	MANGUERA SUP.	DOHC
		38276	TENSOR MICRO-V	B. AGUA		T42036	POLEA BANDA DE TIEMPO	SUPERIOR
		38186	TENSOR MICRO-V	ACCESORIO		T42034	POLEA BANDA DE TIEMPO	INFERIOR
		33248	TERMOSTATO	195°F		38006	POLEA DEL TENSOR	
						38001	POLEA LOCA	
						K060854	SERPENTIN	DOHC
						K060468	SERPENTIN	SOHC; S/AA
						K060507	SERPENTIN	C/AA
						K060465	SERPENTIN	S/AA
						31109	TAPON DE ACEITE	
						31828	TAPON DE GASOLINA	CON LLAVE REGULAR
						31830	TAPON DE GASOLINA	SIN LLAVE REGULAR
						31536	TAPON DE RADIADOR	(20 lbs) Con Palanca
						T43004	TENSOR ARBOL DE LEVAS	
						T43003	TENSOR ARBOL DE LEVAS	
						38162	TENSOR MICRO-V	DOHC
						38171	TENSOR MICRO-V	SOHC
<b>ESCORT</b>								
4 CIL, 2.0 L	2002	T283	BANDA ARBOL DE LEVAS	DOHC		T294	BANDA ARBOL DE LEVAS	
		22399	CALEF. A B.A.			22398	CALEF. A TERMOSTATO	
		354020(802)	EDH	PRESION		TCK294A	KIT DE DISTRIBUCION	10-Feb-99 hasta 2003 T42036
		TCK283	KIT DE DISTRIBUCION	SOHC		21922	MANGUERA INF.	
		21514	MANGUERA SUP.			T42036	POLEA BANDA DE TIEMPO	
		T42036	POLEA BANDA DE TIEMPO	SUPERIOR				

    				    				
4 CIL, 2.0 L	2000	33339	TERMOSTATO	195°F		38171	TENSOR MICRO-V	
4 CIL, 2.0 L	1999	T294	BANDA ARBOL DE LEVAS	DOHC		33299	TERMOSTATO	195°F
		T283	BANDA ARBOL DE LEVAS					
		22399	CALEF. A BA	SOHC				
		19058	CALEF. A TERMOSTATO	DOHC				
		22398	CALEF. A TERMOSTATO	SOHC				
		18951	CALEF. A TUBO-1	DOHC				
		354020(802)	EDH	PRES. DESDE LA BOMBA A L				
		TCK283	KIT DE DISTRIBUCION	SOHC				
		TCK294	KIT DE DISTRIBUCION	DOHC				
		TCK294A	KIT DE DISTRIBUCION	SOHC				
		28466	MANGUERA DE PASO	Ene 1998 hasta 9-Feb-99 T420				
		22346	MANGUERA INF.	10-Feb-99 hasta 2003 T42036				
		21922	MANGUERA INF.	DOHC				
		CH-130041	MANGUERA SUP.	SOHC				
		21514	MANGUERA SUP.	SOHC	V-10, 6.8 L			
		22347	MANGUERA SUP.	DOHC				
		T42034	POLEA BANDA DE TIEMPO	INFERIOR				
		T42036	POLEA BANDA DE TIEMPO	SUPERIOR				
		T42035	POLEA BANDA DE TIEMPO	SUPERIOR				
		38006	POLEA DEL TENSOR					
		38001	POLEA LOCA					
		K060507	SERPENTIN	C/AA				
		K060854	SERPENTIN	DOHC				
		K060505	SERPENTIN	SOHC; C/AA				
		K060468	SERPENTIN	SOHC; S/AA	V-10, 6.8 L			
		K060465	SERPENTIN	S/AA				
		31109	TAPON DE ACEITE					
		31830	TAPON DE GASOLINA	SIN LLAVE REGULAR				
		31828	TAPON DE GASOLINA	CON LLAVE REGULAR				
		31536	TAPON DE RADIADOR	(20 lbs) Con Palanca				
		T43004	TENSOR ARBOL DE LEVAS					
		T43003	TENSOR ARBOL DE LEVAS					
		38162	TENSOR MICRO-V	DOHC				
		38171	TENSOR MICRO-V	SOHC				
		33339	TERMOSTATO	195°F				
4 CIL, 2.0 L	1998	T294	BANDA ARBOL DE LEVAS	{129 D x 25.4 mm}	V-8, 4.6 L			
		T283	BANDA ARBOL DE LEVAS	{99 D x 25.4 mm}				
		354020(802)	EDH	PRESION				
		TCK294	KIT DE DISTRIBUCION	Ene 1998 hasta 9-Feb-99 T420	V-10, 6.8 L			
		TCK283	KIT DE DISTRIBUCION	SOHC				
		28466	MANGUERA DE PASO					
		22346	MANGUERA INF.					
		21922	MANGUERA INF.					
		CH-130041	MANGUERA SUP.					
		22347	MANGUERA SUP.					
		T42034	POLEA BANDA DE TIEMPO	INFERIOR				
		T42035	POLEA BANDA DE TIEMPO	SUPERIOR				
		38006	POLEA LOCA					
		38001	POLEA LOCA					
		K060507	SERPENTIN	C/AA				
		K060468	SERPENTIN	S/AA				
		K060854	SERPENTIN	C/AA	V-8, 5.4 L			
		K060465	SERPENTIN	S/AA				
		31109	TAPON DE ACEITE					
		31830	TAPON DE GASOLINA	SIN LLAVE REGULAR				
		31828	TAPON DE GASOLINA	CON LLAVE REGULAR				
		31336	TAPON DE RADIADOR	(16 lbs) Sin Palanca				
		T43003	TENSOR ARBOL DE LEVAS					
		T43004	TENSOR ARBOL DE LEVAS					
		38162	TENSOR MICRO-V		V-10, 6.8 L			
		38171	TENSOR MICRO-V					
		33339	TERMOSTATO	195°F				
4 CIL, 1.8 L	1997	BDH-5168	BOMBA DE DIR. HIDR.					
		31336	TAPON DE RADIADOR	(16 lbs) Sin Palanca				
4 CIL, 1.9 L	1997	BDH-6388	BOMBA DE DIR. HIDR.					
		K060507	SERPENTIN					
		31336	TAPON DE RADIADOR	(16 lbs) Sin Palanca				
4 CIL, 2.0 L	1997	T283	BANDA ARBOL DE LEVAS					
		TCK283	KIT DE DISTRIBUCION	SOHC				
		21922	MANGUERA INF.					
		CH-130041	MANGUERA SUP.					
		38001	POLEA LOCA					
		31336	TAPON DE RADIADOR	(16 lbs) Sin Palanca				
		T43004	TENSOR ARBOL DE LEVAS		V-8, 5.4 L			











## EXCURSION

V-10, 6.8 L	2005	352860(803)	ENSAMBLE DE DIR. HIDR.	PRESION
		22432	MANG. INF.	
		22431	MANG. SUP.	
		38022	POLEA	
		K060990	SERPENTIN	C/AA
		31109	TAPON DE ACEITE	
		31830	TAPON DE GASOLINA	SIN LLAVE REGULAR
		31406	TAPON DE RADIADOR	(16 lbs) Sin Palanca
		38274	TENSOR MICRO-V	
		33469	TERMOSTATO	195°F
V-10, 6.8 L	2004	352860(803)	EDH	PRESION
		22432	MANGUERA INF.	
		22431	MANGUERA SUP.	
		38022	POLEA	
		K060990	SERPENTIN	C/AA
		31109	TAPON DE ACEITE	
		31828	TAPON DE GASOLINA	CON LLAVE REGULAR
		31406	TAPON DE RADIADOR	(16 lbs) Sin Palanca
		38274	TENSOR MICRO-V	
		33469	TERMOSTATO	195°F
V-10, 6.8 L	2003	352860(803)	EDH	PRESION
		22430	MANGUERA INF.	
		22431	MANGUERA SUP.	
		38022	POLEA	
		K060990	SERPENTIN	C/AA
		K080806	SERPENTIN	S/AA
		31109	TAPON DE ACEITE	
		31828	TAPON DE GASOLINA	CON LLAVE REGULAR
		31406	TAPON DE RADIADOR	(16 lbs) Sin Palanca
		38133	TENSOR MICRO-V	C/AA
		38274	TENSOR MICRO-V	
		38001	POLEA LOCA	LISA
		K061010	SERPENTIN	
		352860(803)	EDH	PRESION
		22430	MANGUERA INF.	
		22431	MANGUERA SUP.	
		38023	POLEA DEL TENSOR	LISA
		38022	POLEA LOCA	
		K080991	SERPENTIN	C/AA
		K080806	SERPENTIN	S/AA
		31109	TAPON DE ACEITE	
		31830	TAPON DE GASOLINA	SIN LLAVE REGULAR
		31828	TAPON DE GASOLINA	CON LLAVE REGULAR
		31406	TAPON DE RADIADOR	(16 lbs) Sin Palanca
		38133	TENSOR MICRO-V	C/AA
		38274	TENSOR MICRO-V	
V-8, 5.4 L	2002	352850(803)	EDH	PRESION
		22430	MANGUERA INF.	
		22429	MANGUERA SUP.	
		K060990	SERPENTIN	
		31109	TAPON DE ACEITE	
		31828	TAPON DE GASOLINA	CON LLAVE REGULAR
		31830	TAPON DE GASOLINA	SIN LLAVE REGULAR
		31406	TAPON DE RADIADOR	(16 lbs) Sin Palanca
		33479	TERMOSTATO	195°F
V-10, 6.8 L	2001	352860(803)	EDH	PRESION
		22432	MANGUERA INF.	
		22431	MANGUERA SUP.	
		38023	POLEA	LISO
		38022	POLEA	
		K080991	SERPENTIN	C/AA
		K080806	SERPENTIN	S/AA
		31109	TAPON DE ACEITE	
		31828	TAPON DE GASOLINA	CON LLAVE REGULAR
		31830	TAPON DE GASOLINA	SIN LLAVE REGULAR
		31406	TAPON DE RADIADOR	(16 lbs) Sin Palanca
		38133	TENSOR MICRO-V	
		33469	TERMOSTATO	195°F
V-8, 5.4 L	2001	352850(803)	EDH	PRESION

    				    					
V-8, 5.4 L	2001	22430 22429 38023 38022 K080991 K080806 31109 31830 31828 31406 38133	MANGUERA INF. MANGUERA SUP. POLEA DEL TENSOR - LISA POLEA LOCA SERPENTIN SERPENTIN TAPON DE ACEITE TAPON DE GASOLINA TAPON DE GASOLINA TAPON DE RADIADOR TENSOR MICRO-V	C/AA S/AA SIN LLAVE REGULAR CON LLAVE REGULAR (16 lbs) Sin Palanca C/AA PRESION	V-8, 5.4 L	2005	33469 22858 38001 36157 38006 K061015 31275 31841 31842 31406 38274 33469 38001 K061005 31109 31828 31406 38274 33469	TERMOSTATOS MANGUERA SUP. POLEA POLEA POLEA DEL TENSOR SERPENTIN TAPON DE ACEITE TAPON DE GASOLINA TAPON DE GASOLINA TAPONES DE RADIADOR TENSOR TERMOSTATOS POLEA SERPENTIN TAPON DE ACEITE TAPON DE GASOLINA TAPON DE RADIADOR TENSOR MICRO-V TERMOSTATO	195° LISA RANURADA CON LLAVE 16 LBS. 195° LISA CON LLAVE REGULAR (16 lbs) Sin Palanca 195°F
V-10, 6.8 L	2000	352860(803) 22432 22431 38023 38022 K080991 K080806 31828 38133	MANGUERA INF. MANGUERA SUP. POLEA POLEA LOCA SERPENTIN SERPENTIN TAPON DE GASOLINA TENSOR MICRO-V	LISO C/AA S/AA CON LLAVE REGULAR PRESION	V-8, 4.6 L	2004	38001 K061005 31109 31828 31406 38274 33469 K061005 31109 31828 31406 38274 33469	POLEA SERPENTIN TAPON DE ACEITE TAPON DE GASOLINA TAPON DE RADIADOR TENSOR MICRO-V TERMOSTATO SERPENTIN TAPON DE ACEITE TAPON DE GASOLINA TAPON DE RADIADOR TENSOR MICRO-V TERMOSTATO	LISA CON LLAVE REGULAR (16 lbs) Sin Palanca 195°F
V-8, 5.4 L	2000	352850(803) 22430 22429 38023 K080806 K080991 31828 38133	EDH MANGUERA INF. MANGUERA SUP. POLEA DEL TENSOR SERPENTIN SERPENTIN TAPON DE GASOLINA TENSOR MICRO-V	S/AA C/AA CON LLAVE REGULAR PRESION	V-8, 4.6 L	2003	38006 38001 K061010 31828 31406 38274 38006 38001 K061005 31109 31828 31406 38274	POLEA POLEA LOCA SERPENTIN TAPON DE GASOLINA TAPON DE RADIADOR TENSOR MICRO-V POLEA POLEA LOCA SERPENTIN TAPON DE GASOLINA TAPON DE RADIADOR TENSOR MICRO-V	LISA CON LLAVE REGULAR (16 lbs) Sin Palanca LISA CON LLAVE REGULAR (16 lbs) Sin Palanca











**EXPEDITION**

V-8, 5.4 L	2010	36157 38001 38006 K061025 38274	POLEA POLEA POLEA DEL TENSOR SERPENTIN TENSOR	RANURADA LISA	V-8, 5.4 L	2003	38006 38001 K061005 31109 31828 31406 38274	POLEA POLEA POLEA DEL TENSOR SERPENTIN TAPON DE ACEITE TAPON DE GASOLINA TAPON DE RADIADOR TENSOR MICRO-V	LISA CON LLAVE 16 LBS. 195° LISA RANURADA
V-8, 5.4 L	2009	38001 36157 38006 K061025 31841 31842 31336 38274 33469	POLEA POLEA POLEA DEL TENSOR SERPENTIN TAPON DE GASOLINA TAPON DE GASOLINA TAPONES DE RADIADOR TENSOR TERMOSTATOS	LISA RANURADA	V-8, 4.6 L	2002	19199 22538 19193 22513 22295 22302 38023 38022 K060984 35B 3/8"	CALEF. A MULTIPLE CALEF. A MULTIPLE CALEF. A TUBO-1 CALEF. A TUBO-1 MANGUERA INF. MANGUERA SUP. POLEA DEL TENSOR POLEA LOCA SERPENTIN TANQUE DE RECUP. A RADIAD(	S/Calefactor Auxiliar; Re-usar e C/Calefactor Auxiliar S/Calefactor Auxiliar C/Calefactor Auxiliar
V-8, 5.4 L	2008	38001 36157 38006 K061031 31275 31841 31842 31406 38274 33469	POLEA POLEA POLEA DEL TENSOR SERPENTIN TAPON DE ACEITE TAPON DE GASOLINA TAPON DE GASOLINA TAPONES DE RADIADOR TENSOR TERMOSTATOS	RANURADA	V-8, 5.4 L	2002	30T 5/8"	TUBO A CALEF. AUXILIAR TUBO-2 A MOTOR	LISA
V-8, 5.4 L	2007	36157 38001 38006 K061031 31275 31841 31842 31406 38274 33469	POLEA POLEA POLEA DEL TENSOR SERPENTIN TAPON DE ACEITE TAPON DE GASOLINA TAPON DE GASOLINA TAPONES DE RADIADOR TENSOR TERMOSTATOS	RANURADA LISA	V-8, 5.4 L	2002	19199 22538 19193 22513 22297 22295 22294 22302 38023 38022 K060984 35B 3/8"	CALEF. A MULTIPLE CALEF. A MULTIPLE CALEF. A TUBO-1 CALEF. A TUBO-1 MANGUERA INF. MANGUERA INF. MANGUERA INF. MANGUERA SUP. POLEA DEL TENSOR POLEA LOCA SERPENTIN TANQUE DE RECUP. A RADIAD(	S/Calefactor Auxiliar; Re-usar e C/Calefactor Auxiliar S/Calefactor Auxiliar C/Calefactor Auxiliar C/2WD S/Enfriador de aceite C/4WD - doble tracción
V-8, 5.4 L	2006	22858 38001 36157 38006 K061015 31275 31841 31842 31406 38274	MANGUERA SUP. POLEA POLEA POLEA DEL TENSOR SERPENTIN TAPON DE ACEITE TAPON DE GASOLINA TAPON DE GASOLINA TAPONES DE RADIADOR TENSOR	LISA RANURADA	V-8, 5.4 L	2002	31109 31828 31830 31406 38133 38274 33469 28466	TAPON DE ACEITE TAPON DE GASOLINA TAPON DE GASOLINA TAPON DE RADIADOR TENSOR MICRO-V TENSOR MICRO-V TUBO A CALEF. AUXILIAR	CON LLAVE REGULAR SIN LLAVE REGULAR (16 lbs) Sin Palanca C/AA LISA

    				    					
V-8, 4.6 L	2001	19199	CALEF. A MULTIPLE	S/Calef. Auxiliar; Re-usar el res	1999	31830	TAPON DE GASOLINA	SIN LLAVE REGULAR	
		22538	CALEF. A MULTIPLE	C/Calef. Auxiliar		38133	SENSOR MICRO-V	C/AA	
		19193	CALEF. A TUBO-1	S/Calef. Auxiliar		V-8, 5.4 L	19219	CALEF. A MULTIPLE	S/Calef. Auxiliar; Re-usar el res
		22513	CALEF. A TUBO-1	C/Calef. Auxiliar		22540	CALEF. A MULTIPLE	C/Calef. Auxiliar; Re-usar el res	
		22295	MANGUERA INF.			19193	CALEF. A TUBO-1	S/Calef. Auxiliar	
		22302	MANGUERA SUP.			22513	CALEF. A TUBO-1	C/Calef. Auxiliar	
		38022	POLEA			22294	MANGUERA INF.	C/ENF. DE ACEITE	
		38023	POLEA	LISO		22295	MANGUERA INF.	S/ENF DE ACEITE	
		K080981	SERPENTIN			22297	MANGUERA INF.	C/2WD	
		31109	TAPON DE ACEITE			22302	MANGUERA SUP.		
		31828	TAPON DE GASOLINA	CON LLAVE REGULAR		38022	POLEA		
		31830	TAPON DE GASOLINA	SIN LLAVE REGULAR		38023	POLEA	LISO	
		31406	TAPON DE RADIADOR	(16 lbs) Sin Palanca		K080981	SERPENTIN	C/AA, 130 AMP	
		38133	SENSOR MICRO-V	C/AA		31830	TAPON DE GASOLINA	SIN LLAVE REGULAR	
		33469	TERMOSTATO	195°F		31828	TAPON DE GASOLINA	CON LLAVE REGULAR	
V-8, 5.4 L	2001	19199	CALEF. A MULTIPLE	S/Calef. Auxiliar; Re-usar el res	1998	38133	SENSOR MICRO-V		
		22538	CALEF. A MULTIPLE	C/Calef. Auxiliar		V-8, 4.6 L	353920(802)	EDH	PRESION
		19193	CALEF. A TUBO-1	S/Calef. Auxiliar		22295	MANGUERA INF.		
		22513	CALEF. A TUBO-1	C/Calef. Auxiliar		22302	MANGUERA SUP.		
		22295	MANGUERA INF.	S/ENF DE ACEITE		38023	POLEA	LISO	
		22297	MANGUERA INF.	C/2WD		38022	POLEA LOCA		
		22294	MANGUERA INF.	C/ENF. DE ACEITE		K080981	SERPENTIN	C/AA, C/DH	
		22302	MANGUERA SUP.			31109	TAPON DE ACEITE		
		38022	POLEA			31830	TAPON DE GASOLINA	SIN LLAVE REGULAR	
		38023	POLEA	LISO		31406	TAPON DE RADIADOR	(16 lbs) Sin Palanca	
		K080981	SERPENTIN			38133	SENSOR MICRO-V		
		31109	TAPON DE ACEITE			33469	TERMOSTATO	195°F	
		31828	TAPON DE GASOLINA	CON LLAVE REGULAR		22294	MANGUERA INF.	C/ENF. DE ACEITE	
		31830	TAPON DE GASOLINA	SIN LLAVE REGULAR		22295	MANGUERA INF.	S/ENF DE ACEITE	
		31406	TAPON DE RADIADOR	(16 lbs) Sin Palanca		22302	MANGUERA SUP.		
38133	SENSOR MICRO-V	C/AA	38023	POLEA	LISO				
33469	TERMOSTATO	195°F	38022	POLEA					
V-8, 4.6 L	2000	19199	CALEF. A MULTIPLE	S/Calef. Auxiliar; Re-usar el res	1997	K080981	SERPENTIN	C/AA, 130 AMP	
		22538	CALEF. A MULTIPLE	C/Calef. Auxiliar		38133	SENSOR MICRO-V		
		19193	CALEF. A TUBO-1	S/Calef. Auxiliar		V-8, 4.6 L	353920(802)	EDH	PRESION
		22513	CALEF. A TUBO-1	C/Calef. Auxiliar		22295	MANGUERA INF.		
		22295	MANGUERA INF.			22302	MANGUERA SUP.		
		22302	MANGUERA SUP.			38023	POLEA		
		38022	POLEA			38022	POLEA LOCA		
		38023	POLEA	LISO		K080981	SERPENTIN	C/AA, C/DH	
		K080981	SERPENTIN	C/AA, C/DH		31109	TAPON DE ACEITE		
		31109	TAPON DE ACEITE			31830	TAPON DE GASOLINA	SIN LLAVE REGULAR	
		31828	TAPON DE GASOLINA	CON LLAVE REGULAR		31406	TAPON DE RADIADOR	(16 lbs) Sin Palanca	
		31830	TAPON DE GASOLINA	SIN LLAVE REGULAR		38133	SENSOR MICRO-V		
		31406	TAPON DE RADIADOR	(16 lbs) Sin Palanca		33469	TERMOSTATO	195°F	
		38133	SENSOR MICRO-V	C/AA		22294	MANGUERA INF.	C/ENF. DE ACEITE	
		33469	TERMOSTATO	195°F		22295	MANGUERA INF.	S/ENF DE ACEITE	
V-8, 5.4 L	2000	19199	CALEF. A MULTIPLE	S/Calef. Auxiliar; Re-usar el res	2010	38001	POLEA		
		22538	CALEF. A MULTIPLE	C/Calef. Auxiliar		V-6, 4.0 L	K060860	SERPENTIN	
		19193	CALEF. A TUBO-1	S/Calef. Auxiliar		38137	TENSOR		
		22513	CALEF. A TUBO-1	C/Calef. Auxiliar		38001	POLEA	LISA	
		22297	MANGUERA INF.			36157	POLEA	RANURADA	
		22295	MANGUERA INF.			30006	POLEA DEL TENSOR		
		22294	MANGUERA INF.			K061025	SERPENTIN		
		22302	MANGUERA SUP.			38274	TENSOR		
		38023	POLEA			22038	MANGUERA DE PASO		
		38022	POLEA			23364	MANGUERA INF.		
		K080981	SERPENTIN	C/AA, 130 AMP		23363	MANGUERA SUP.		
		31109	TAPON DE ACEITE			38001	POLEA		
		31828	TAPON DE GASOLINA	CON LLAVE REGULAR		38008	POLEA DEL TENSOR		
		31830	TAPON DE GASOLINA	SIN LLAVE REGULAR		K060860	SERPENTIN		
		31406	TAPON DE RADIADOR	(16 lbs) Sin Palanca		31275	TAPON DE ACEITE		
38133	SENSOR MICRO-V		31841	TAPON DE GASOLINA					
33469	TERMOSTATO	195°F	31842	TAPON DE GASOLINA	CON LLAVE				
V-8, 4.6 L	1999	19219	CALEF. A MULTIPLE	S/Calef. Auxiliar; Re-usar el res	2009	31551	TAPONES DE RADIADOR	20 LBS.	
		22540	CALEF. A MULTIPLE	C/Calef. Auxiliar; Re-usar el res		38137	TENSOR		
		19193	CALEF. A TUBO-1	S/Calef. Auxiliar		V-6, 4.0 L	33079	TERMOSTATOS	195°
		22513	CALEF. A TUBO-1	C/Calef. Auxiliar					
		353920(802)	EDH	PRESION					
		22295	MANGUERA INF.						
		22302	MANGUERA SUP.						
		38022	POLEA						
		38023	POLEA	LISO					
		K080981	SERPENTIN	C/AA, C/DH					
		31828	TAPON DE GASOLINA	CON LLAVE REGULAR					

## EXPLORER













    				    					
V-8, 4.6 L	2009	23362 36157 38001 30006 K061025 31275 31842 31841 31551 38274 33469	MANGUERA INF. POLEA POLEA POLEA DEL TENSOR SERPENTIN TAPON DE ACEITE TAPON DE GASOLINA TAPON DE GASOLINA TAPONES DE RADIADOR TENSOR TERMOSTATOS	RANURADA LISA  CON LLAVE 20 LBS. 195°	V-6, 4.0 L	2006	33469 33469 22793 22691 38001 K060854 K060866 31830 31406 38137 33079	TERMOSTATO TERMOSTATOS MANG. INF. MANG. SUP. POLEA LOCA SERPENTIN SERPENTIN TAPON DE GASOLINA TAPON DE RADIADOR TENSOR MICRO-V TERMOSTATO	195°F 195°   C/AA VER. SPORT SIN LLAVE REGULAR (16 lbs) Sin Palanca  195°F
V-6, 4.0 L	2008	22038 23364 23363 38001 38008 K060860 31275 31841 31842 31551 38137 33079	MANGUERA DE PASO MANGUERA INF. MANGUERA SUP. POLEA POLEA DEL TENSOR SERPENTIN TAPON DE ACEITE TAPON DE GASOLINA TAPON DE GASOLINA TAPONES DE RADIADOR TENSOR TERMOSTATOS	CON LLAVE 20 LBS. 195°	V-8, 4.6 L	2006	22790 22791 38001 38006 K061010 31842 31406 38274 33469 22793 22691 38001	MANG. INF. MANG. SUP. POLEA POLEA SERPENTIN TAPON DE GASOLINA TAPON DE RADIADOR TENSOR MICRO-V TERMOSTATO MANG. INF. MANG. SUP. POLEA LOCA SERPENTIN	195°F    C/AA CON LLAVE REGULAR (16 lbs) Sin Palanca  195°F
V-8, 4.6 L	2008	23362 36157 38001 30006 K061025 31275 31841 31842 31551 38274 33469	MANGUERA INF. POLEA POLEA POLEA DEL TENSOR SERPENTIN TAPON DE ACEITE TAPON DE GASOLINA TAPON DE GASOLINA TAPONES DE RADIADOR TENSOR TERMOSTATOS	RANURADA LISA  CON LLAVE 20 LBS. 195°	V-8, 4.6 L	2005	22790 22791 38001 K060854 K060866 31830 31406 38137 33079 22790 22791 38001 38006 K061010	MANG. INF. MANG. SUP. POLEA LOCA SERPENTIN SERPENTIN TAPON DE GASOLINA TAPON DE RADIADOR TENSOR MICRO-V TERMOSTATO MANG. INF. MANG. SUP. POLEA POLEA SERPENTIN	195°F   C/AA VER. SPORT SIN LLAVE REGULAR (16 lbs) Sin Palanca  195°F
V-6, 4.0 L	2007	22793 22691 22038 23364 23363 38001 38008 38001 K060860 K060854 K060866 31275 31275 31841 31842 31830 31406 31551 38137 38137 33079 33079	MANG. INF. MANG. SUP. MANGUERA DE PASO MANGUERA INF. MANGUERA SUP. POLEA POLEA DEL TENSOR POLEA LOCA SERPENTIN SERPENTIN SERPENTIN TAPON DE ACEITE TAPON DE ACEITE TAPON DE GASOLINA TAPON DE GASOLINA TAPON DE RADIADOR TAPONES DE RADIADOR TENSOR TENSOR MICRO-V TERMOSTATO TERMOSTATOS	C/AA VER. SPORT  CON LLAVE SIN LLAVE REGULAR (16 lbs) Sin Palanca 20 LBS. 195°F 195°	V-6, 4.0 L	2004	22793 22691 38001 K060854 31830 31406 38137 33079 22790 22791 38001 38006 K060854 31842 31406 38274 33469 22793 22691 38001 K060854 31830 31406 38137 33079 22790 22791 38001 38006 K060854 31842 31406 38274 33469 22793 22691 38001 K060854 31828 31336 38137 33079 38006 38001 38022 K061010 35B 3/8"	MANGUERA INF. MANGUERA SUP. MANGUERA INF. MANGUERA SUP. POLEA LOCA SERPENTIN TAPON DE GASOLINA TAPON DE RADIADOR TENSOR MICRO-V TERMOSTATO MANGUERA SUP. POLEA LOCA SERPENTIN TAPON DE GASOLINA TAPON DE RADIADOR TENSOR MICRO-V TERMOSTATO MANGUERA SUP. POLEA DEL TENSOR POLEA LOCA SERPENTIN TAPON DE GASOLINA TAPON DE RADIADOR TENSOR MICRO-V TERMOSTATO MANGUERA SUP. POLEA LOCA SERPENTIN TANQUE DE RECUP. A RADIAD	195°F   195°F   C/AA SIN LLAVE REGULAR (16 lbs) Sin Palanca  195°F   C/AA CON LLAVE REGULAR (16 lbs) Sin Palanca  195°F   LISO LISO LISA C/AA CON LLAVE REGULAR (16 lbs) Sin Palanca  195°F   LISO LISA C/AA CON LLAVE REGULAR (16 lbs) Sin Palanca  195°F C/AA, VIN E  C/AA CON LLAVE REGULAR (16 lbs) Sin Palanca  195°F   C/AA CON LLAVE REGULAR (16 lbs) Sin Palanca  195°F C/Calefactor Auxiliar PRESION
V-8, 4.6 L	2007	22790 22791 23362 23361 38001 36157 38001 38006 30006 K061010 K061025 31275 31842 31841 31842 31406 31551 38274 38274	MANG. INF. MANG. SUP. MANGUERA INF. MANGUERA SUP. POLEA POLEA POLEA POLEA DEL TENSOR SERPENTIN SERPENTIN TAPON DE ACEITE TAPON DE GASOLINA TAPON DE GASOLINA TAPON DE GASOLINA TAPON DE RADIADOR TAPONES DE RADIADOR TENSOR TENSOR MICRO-V TERMOSTATO TERMOSTATOS	LISA RANURADA  CON LLAVE SIN LLAVE REGULAR (16 lbs) Sin Palanca 20 LBS. 195°F 195°	V-6, 4.0 L	2003	21145 38008 38001 K060858 31828 31336 38137 33079 38006 38001 38022 K061010 35B 3/8" 31828 31406 38274 33079 30T 5/8" 80086 20470	MANGUERA SUP. POLEA DEL TENSOR POLEA LOCA SERPENTIN TAPON DE GASOLINA TAPON DE RADIADOR TENSOR MICRO-V TERMOSTATO POLEA POLEA POLEA LOCA SERPENTIN TAPON DE GASOLINA TAPON DE RADIADOR TENSOR MICRO-V TERMOSTATO VALVULA DEL CALEF. A "T" EDH MANGUERA INF.	195°F C/AA, VIN E  C/AA CON LLAVE REGULAR (16 lbs) Sin Palanca  195°F   LISO LISA C/AA CON LLAVE REGULAR (16 lbs) Sin Palanca  195°F   C/AA CON LLAVE REGULAR (16 lbs) Sin Palanca  195°F C/Calefactor Auxiliar PRESION





























    				    				
V-8, 5.4 L	2000	38023 POLEA DEL TENSOR 38022 POLEA LOCA K080797 SERPENTIN K080991 SERPENTIN K080660 SERPENTIN 31109 TAPON DE ACEITE 31830 TAPON DE GASOLINA 31828 TAPON DE GASOLINA 31406 TAPON DE RADIADOR 38133 TENSOR MICRO-V 38330 TENSOR MICRO-V 33469 TERMOSTATO	C/AA C/AA S/AA C/AA SUPERCARGADO  SIN LLAVE REGULAR CON LLAVE REGULAR (16 lbs) Sin Palanca C/AA  195°F	V-8, 5.8 L	CH-136623 MANGUERA DE PASO CH-136502 MANGUERA INF. CH-137581 MANGUERA SUP. CH-135581 MANGUERA SUP. 15T222 MANGUERA SUP. FLEXIBLE K061020 SERPENTIN 20609 MANGUERA INF. CH-130011 MANGUERA SUP. 15T350 MANGUERA SUP. FLEXIBLE K060970 SERPENTIN K060980 SERPENTIN CH-136623 MANGUERA INF. CH-136502 MANGUERA INF. CH-136502 MANGUERA SUP. CH-135581 MANGUERA SUP. 21220 MANGUERA SUP. K060990 SERPENTIN CH-136623 MANGUERA DE PASO CH-136502 MANGUERA INF. CH-135581 MANGUERA SUP. CH-137581 MANGUERA SUP. CH-131282 MANGUERA SUP. 15T222 MANGUERA SUP. FLEXIBLE 38006 POLEA 38007 POLEA LOCA K061020 SERPENTIN 38123 TENSOR MICRO-V 21875 MANGUERA INF. 21909 MANGUERA INF. 21668 MANGUERA SUP. 1517T200 MANGUERA SUP. FLEXIBLE 38001 POLEA DEL TENSOR K060685 SERPENTIN 38140 TENSOR MICRO-V	V-6, 4.9 L	1997	S/AA C/AA
V-10, 6.8 L	1999	22431 MANGUERA SUP. 38023 POLEA DEL TENSOR 38022 POLEA LOCA K081000 SERPENTIN K080806 SERPENTIN 38133 TENSOR MICRO-V	C/AA S/AA	V-8, 5.0 L	1997			
V-6, 4.2 L	1999	19114 CALEF. A TERMOSTATO 22299 MANGUERA INF. 22301 MANGUERA SUP. 19025 PASO 38009 POLEA 38007 POLEA DEL TENSOR 38001 POLEA LOCA LISA K060966 SERPENTIN K061031 SERPENTIN K060895 SERPENTIN K060832 SERPENTIN 38138 TENSOR MICRO-V	RE-USAR EL RESTRICTOR D C/AA, C/DH C/AA, C/DH  C/AA S/AA, 7 POLEAS C/AA, 8 POLEAS C/AA, 7 POLEAS S/AA, 6 POLEAS	V-8, 5.8 L	1997		S/AA C/AA	
V-8, 4.6 L	1999	19219 CALEF. A MULTIPLE 19193 CALEF. A TUBO-1 22298 MANGUERA INF. 22302 MANGUERA SUP. 38053 POLEA 38022 POLEA 38023 POLEA DEL TENSOR K080806 SERPENTIN K080991 SERPENTIN K080797 SERPENTIN 38133 TENSOR MICRO-V 38330 TENSOR MICRO-V	Re-usar el restrictor de flujo   S/AA, 110 AMP C/AA S/AA C/AA	V-8, 7.5 L	1997		C/ALT 60 A	
V-8, 4.6 L	1999	19193 CALEF. A TUBO-1 22297 MANGUERA INF. 22298 MANGUERA INF. 22430 MANGUERA INF. 22302 MANGUERA SUP. 22429 MANGUERA SUP. 38053 POLEA 38023 POLEA DEL TENSOR 38022 POLEA LOCA K080991 SERPENTIN K080797 SERPENTIN K080660 SERPENTIN 38133 TENSOR MICRO-V 38330 TENSOR MICRO-V	S/Paquete SVT Pkg; exc Lightr S/AA, C/AA- C/DH	V-8, 4.6 L	2010	36157 POLEA 38001 POLEA K061025 SERPENTIN 31842 TAPON DE GASOLINA 31841 TAPON DE GASOLINA 31336 TAPONES DE RADIADOR 38274 TENSOR 33469 TERMOSTATOS 36157 POLEA 38001 POLEA K061025 SERPENTIN 31841 TAPON DE GASOLINA 31842 TAPON DE GASOLINA 31336 TAPONES DE RADIADOR 38274 TENSOR 33469 TERMOSTATOS 23267 MANGUERA INF. 23274 MANGUERA SUP. 38001 POLEA K060966 SERPENTIN K061015 SERPENTIN 38138 TENSOR 22859 MANGUERA INF. 22863 MANGUERA SUP. 36157 POLEA 38001 POLEA K061025 SERPENTIN K060840 SERPENTIN 38329 TENSOR 38274 TENSOR	RANURADA LISA CON A.A. CON LLAVE  16 LBS. CON A.A. 195° RANURADA LISA CON A.A. CON LLAVE 16 LBS. CON A.A. 195°  RANURADA LISA CON A.A. SIN A.A. SIN A.A. CON A.A.	
V-8, 5.4 L	1999	22297 MANGUERA INF. 22298 MANGUERA INF. 22430 MANGUERA INF. 22302 MANGUERA SUP. 22429 MANGUERA SUP. 38053 POLEA 38023 POLEA DEL TENSOR 38022 POLEA LOCA K080991 SERPENTIN K080797 SERPENTIN K080660 SERPENTIN 38133 TENSOR MICRO-V 38330 TENSOR MICRO-V		V-8, 4.6 L	2009			
V-6, 4.2 L	1998	22299 MANGUERA INF. 22301 MANGUERA SUP. 38001 POLEA 38009 POLEA 38007 POLEA DEL TENSOR K061031 SERPENTIN K060966 SERPENTIN K060895 SERPENTIN K060832 SERPENTIN 38138 TENSOR MICRO-V	C/AA, 7 POLEAS C/AA, 7 POLEAS LISO  C/AA, 8 POLEAS S/AA, 7 POLEAS C/AA, 7 POLEAS S/AA, 6 POLEAS	V-6, 4.2 L	2008			
V-8, 4.6 L	1998	22298 MANGUERA INF. 22302 MANGUERA SUP. 38053 POLEA 38023 POLEA DEL TENSOR 38022 POLEA LOCA K080797 SERPENTIN K080991 SERPENTIN 38133 TENSOR MICRO-V 38330 TENSOR MICRO-V	C/AA, S/AA  S/AA C/AA C/AA	V-8, 4.6 L	2008			
V-6, 4.2 L	1998	22298 MANGUERA INF. 22302 MANGUERA SUP. 38053 POLEA 38023 POLEA DEL TENSOR 38022 POLEA LOCA K080797 SERPENTIN K080991 SERPENTIN 38133 TENSOR MICRO-V 38330 TENSOR MICRO-V	C/AA, S/AA  S/AA C/AA C/AA	V-6, 4.2 L	2007	19114 MANG. CALEF: A TERMOSTATO 19025 MANG. DE PASO 22299 MANG. INF. 22301 MANG. SUP. 38007 POLEA K061025 SERPENTIN K060966 SERPENTIN K061031 SERPENTIN	RE-USAR EL RESTRICTOR D CORTAR A MEDIDA     S/AA C/AA	

**F-150**

    		    							
V-6, 4.2 L	2007	38138	TENSOR MICRO-V			K060966	SERPENTIN	S/AA	
V-6, 4.2 L	2006	353930(802)	EDH	PRESION		K061031	SERPENTIN	C/AA	
		28466	MANG. CALEF. A B.A.	CORTAR A MEDIDA		31109	TAPON DE ACEITE		
		19114	MANG. CALEF: A TERMOSTAT	RE-USAR EL RESTRICTOR D		38138	TENSOR MICRO-V		
		19025	MANG. DE PASO	CORTAR A MEDIDA	V-6, 4.2 L	2001	353930(802)	EDH	PRESION
		22299	MANG. INF.			22299	MANG. INF.	C/AA	
		22301	MANG. SUP.			22301	MANG. SUP.	C/AA	
		38009	POLEA	S/AA		38007	POLEA		
		38007	POLEA			K060966	SERPENTIN	S/AA	
		38001	POLEA LOCA			K061031	SERPENTIN	C/AA	
		K061031	SERPENTIN	C/AA		31109	TAPON DE ACEITE		
		K060966	SERPENTIN	S/AA		31830	TAPON DE GASOLINA	SIN LLAVE REGULAR	
		31109	TAPON DE ACEITE			31406	TAPON DE RADIADOR	(16 lbs) Sin Palanca	
		31830	TAPON DE GASOLINA	SIN LLAVE REGULAR		38138	TENSOR MICRO-V		
		31406	TAPON DE RADIADOR	(16 lbs) Sin Palanca		33469	TERMOSTATO	195°F	
		38138	TENSOR MICRO-V		V-6, 4.2 L	2000	22299	MANG. INF.	C/AA
		38291	TENSOR MICRO-V	S/AA		22301	MANG. SUP.	C/AA	
		33469	TERMOSTATO	195°F		38007	POLEA		
V-6, 4.2 L	2005	353930(802)	EDH	PRESION		K069070	SERPENTIN	S/AA	
		28466	MANG. CALEF. A B.A.	CORTAR A MEDIDA		K061025	SERPENTIN	C/AA	
		19114	MANG. CALEF: A TERMOSTAT	RE-USAR EL RESTRICTOR D		38138	TENSOR MICRO-V		
		19025	MANG. DE PASO	CORTAR A MEDIDA	V-6, 4.2 L	1999	BDH-7129	BOMBA DE DIR. HIDR.	
		22299	MANG. INF.			353930(802)	EDH	PRESION	
		22301	MANG. SUP.			22299	MANG. INF.	C/AA	
		38007	POLEA			22301	MANG. SUP.	C/AA	
		38009	POLEA	S/AA		38007	POLEA		
		38001	POLEA LOCA			K061031	SERPENTIN	C/AA, C/8 POINT DRIVE	
		K060966	SERPENTIN	S/AA		K060966	SERPENTIN	S/AA, C/7 POINT DRIVE	
		K061031	SERPENTIN	C/AA		K060832	SERPENTIN	S/AA, C/6 POINT DRIVE	
		31109	TAPON DE ACEITE			K060895	SERPENTIN	C/AA, C/7 POINTER DRIVE	
		31830	TAPON DE GASOLINA	SIN LLAVE REGULAR		31109	TAPON DE ACEITE		
		31406	TAPON DE RADIADOR	(16 lbs) Sin Palanca		31830	TAPON DE GASOLINA	SIN LLAVE REGULAR	
		38138	TENSOR MICRO-V			31406	TAPON DE RADIADOR	(16 lbs) Sin Palanca	
		38291	TENSOR MICRO-V	S/AA		38138	TENSOR MICRO-V		
		33469	TERMOSTATO	195°F		33469	TERMOSTATO	195°F	
V-6, 4.2 L	2004	353930(802)	EDH	PRESION	V-8, 4.6 L	1999	BDH-7129	BOMBA DE DIR. HIDR.	
		28466	MANG. CALEF. A B.A.	CORTAR A MEDIDA		353920(802)	EDH	PRESION	
		19114	MANG. CALEF: A TERMOSTAT	RE-USAR EL RESTRICTOR DV-8, 5.4 L		1999	BDH-7129	BOMBA DE DIR. HIDR.	
		19025	MANG. DE PASO	CORTAR A MEDIDA		353920(802)	EDH	PRESION	
		22299	MANG. INF.		V-6, 4.2 L	1998	BDH-7129	BOMBA DE DIR. HIDR.	
		22301	MANG. SUP.			353930(802)	EDH	PRESION	
		38009	POLEA	S/AA		22299	MANG. INF.	C/AA	
		38007	POLEA			22301	MANG. SUP.	C/AA	
		38001	POLEA LOCA			38007	POLEA		
		K061031	SERPENTIN	C/AA		K060966	SERPENTIN	S/AA, C/7 POINT DRIVE	
		K060966	SERPENTIN	S/AA		K061031	SERPENTIN	C/AA, C/8 POINT DRIVE	
		31109	TAPON DE ACEITE			K060895	SERPENTIN	C/AA	
		31830	TAPON DE GASOLINA	SIN LLAVE REGULAR		K060832	SERPENTIN	S/AA, C/6 POINT DRIVE	
		31406	TAPON DE RADIADOR	(16 lbs) Sin Palanca		38138	TENSOR MICRO-V		
		38138	TENSOR MICRO-V		V-8, 4.6 L	1998	BDH-7129	BOMBA DE DIR. HIDR.	
		38291	TENSOR MICRO-V	S/AA		353920(802)	EDH	PRESION	
		33469	TERMOSTATO	195°F	V-8, 5.4 L	1998	BDH-7129	BOMBA DE DIR. HIDR.	
V-6, 4.2 L	2003	353930(802)	EDH	PRESION		1997	353920(802)	EDH	PRESION
		28466	MANG. CALEF. A B.A.	CORTAR A MEDIDA	V-6, 4.2 L	1997	BDH-7129	BOMBA DE DIR. HIDR.	
		19114	MANG. CALEF: A TERMOSTAT	RE-USAR EL RESTRICTOR D		353930(802)	EDH	PRESION	
		19025	MANG. DE PASO	CORTAR A MEDIDA	V-6, 4.9 L	1997	20609	MANG. INF.	
		22299	MANG. INF.			CH-130011	MANG. SUP.		
		22301	MANG. SUP.			15T350	MANG. SUP.	FLEXIBLE	
		38007	POLEA			K060980	SERPENTIN	C/AA	
		38009	POLEA	S/AA		K060970	SERPENTIN	S/AA	
		38001	POLEA LOCA		V-8, 4.6 L	1997	BDH-7129	BOMBA DE DIR. HIDR.	
		K061031	SERPENTIN	C/AA		353920(802)	EDH	PRESION	
		K060966	SERPENTIN	S/AA	V-8, 5.4 L	1997	BDH-7129	BOMBA DE DIR. HIDR.	
		31109	TAPON DE ACEITE			353920(802)	EDH	PRESION	
		31830	TAPON DE GASOLINA	SIN LLAVE REGULAR					
		31406	TAPON DE RADIADOR	(16 lbs) Sin Palanca					
		38138	TENSOR MICRO-V		V-8, 4.6 L	2007	K061031	SERPENTIN	
		38291	TENSOR MICRO-V	S/AA		31109	TAPON DE ACEITE		
		33469	TERMOSTATO	195°F		31830	TAPON DE GASOLINA	SIN LLAVE REGULAR	
V-6, 4.2 L	2002	28466	MANG. CALEF. A B.A.	CORTAR A MEDIDA		31406	TAPON DE RADIADOR	(16 lbs) Sin Palanca	
		19114	MANG. CALEF: A TERMOSTAT	RE-USAR EL RESTRICTOR D		38329	TENSOR MICRO-V	S/AA	
		19025	MANG. DE PASO	CORTAR A MEDIDA		38274	TENSOR MICRO-V	C/AA	
		22299	MANG. INF.		V-8, 4.6 L	33469	TERMOSTATO	195°F	
		22301	MANG. SUP.			22859	MANG. INF.		
		38007	POLEA						

## F-250



    				    					
V-8, 4.6 L	2006	22863 K061025 K060840 31109 31830 31406 38329 38274 33469	MANG. SUP. SERPENTIN SERPENTIN TAPON DE ACEITE TAPON DE GASOLINA TAPON DE RADIADOR TENSOR MICRO-V TENSOR MICRO-V TERMOSTATO	C/AA S/AA  SIN LLAVE REGULAR (16 lbs) Sin Palanca S/AA C/AA 195°F	V-8, 5.4 L V-8, 4.6 L	2000 1999	38133 38330 33469 352790(802) 38023 38053 38022 K080991 K080797	TENSOR MICRO-V TENSOR MICRO-V TERMOSTATO EDH POLEA POLEA POLEA LOCA SERPENTIN SERPENTIN	C/AA S/AA 195°F PRESION CON HIDROBOOST S/AA C/AA S/AA
V-8, 4.6 L	2005	22859 22863 K061025 K060840 31109 31830 31406 38329 38274 33469	MANG. INF. MANG. SUP. SERPENTIN SERPENTIN TAPON DE ACEITE TAPON DE GASOLINA TAPON DE RADIADOR TENSOR MICRO-V TENSOR MICRO-V TERMOSTATO	C/AA S/AA  SIN LLAVE REGULAR (16 lbs) Sin Palanca S/AA C/AA 195°F	V-8, 5.4 L V-8, 4.6 L	1999 1998	31109 31830 31406 38133 38330 33469 353920(802) 38053 38023 38022 K080991 K080797	TAPON DE ACEITE TAPON DE GASOLINA TAPON DE RADIADOR TENSOR MICRO-V TENSOR MICRO-V TERMOSTATO EDH POLEA POLEA POLEA LOCA SERPENTIN SERPENTIN	SIN LLAVE REGULAR (16 lbs) Sin Palanca C/AA S/AA 195°F PRESION S/AA
V-8, 4.6 L	2004	38023 38053 38022 K060990 K060798 31109 31830 31406 38329 38274 33469	POLEA POLEA POLEA SERPENTIN SERPENTIN TAPON DE ACEITE TAPON DE GASOLINA TAPON DE RADIADOR TENSOR MICRO-V TENSOR MICRO-V TERMOSTATO	C/AA S/AA  C/AA S/AA  SIN LLAVE REGULAR (16 lbs) Sin Palanca S/AA C/AA 195°F	V-8, 5.4 L V-8, 4.6 L	1998 1997	353920(802) 38053 38023 38022 K080991 K080797 31109 31830 31406 38133 38330 33469 353920(802) 353920(802)	EDH POLEA POLEA POLEA LOCA SERPENTIN SERPENTIN TAPON DE ACEITE TAPON DE GASOLINA TAPON DE RADIADOR TENSOR MICRO-V TENSOR MICRO-V TERMOSTATO EDH EDH	C/AA S/AA  C/AA S/AA  SIN LLAVE REGULAR (16 lbs) Sin Palanca C/AA S/AA 195°F PRESION PRESION
V-8, 4.6 L	2003	38022 38053 38023 K060990 K060798 31109 31830 31406 38274 38329 33469	POLEA POLEA POLEA SERPENTIN SERPENTIN TAPON DE ACEITE TAPON DE GASOLINA TAPON DE RADIADOR TENSOR MICRO-V TENSOR MICRO-V TERMOSTATO	S/AA C/AA C/AA S/AA  SIN LLAVE REGULAR (16 lbs) Sin Palanca C/AA S/AA 195°F	V-8, 6.4 L DIESEL V-8, 6.4 L DIESEL	2010 2009	36234 K060393 K080956 K080865 39051 39052 36234 K080865 K080956 K060393 39051 39052	POLEA SERPENTIN SERPENTIN SERPENTIN TENSOR TENSOR POLEA SERPENTIN SERPENTIN SERPENTIN TENSOR TENSOR	LISA LISA
V-8, 5.4 L V-8, 4.6 L	2003 2002	352790(802) 38022 38053 38023 K060990 K060798 31109 31830 31406 38329 38274 33469	EDH POLEA POLEA POLEA SERPENTIN SERPENTIN TAPON DE ACEITE TAPON DE GASOLINA TAPON DE RADIADOR TENSOR MICRO-V TENSOR MICRO-V TERMOSTATO	PRESION CON HIDROBOOST S/AA C/AA C/AA S/AA  SIN LLAVE REGULAR (16 lbs) Sin Palanca S/AA C/AA 195°F	V-8, 6.4 L DIESEL V-8, 6.4 L DIESEL	2008	36234 K080865 K080956 K060393 39051 39052	POLEA SERPENTIN SERPENTIN SERPENTIN TENSOR TENSOR	LISA
V-8, 5.4 L V-8, 4.6 L	2002 2001	352790(802) 38023 38053 38022 K080991 K080797 31109 31830 31406 38133 38330 33469	EDH POLEA POLEA POLEA SERPENTIN SERPENTIN TAPON DE ACEITE TAPON DE GASOLINA TAPON DE RADIADOR TENSOR MICRO-V TENSOR MICRO-V TERMOSTATO	PRESION CON HIDROBOOST C/AA S/AA  C/AA S/AA  SIN LLAVE REGULAR (16 lbs) Sin Palanca C/AA S/AA 195°F	V-8, 4.6 L V-8, 4.6 L	2001 2000	22298 22302 K080797 K080991 22298 22302 K080991 K080797 22298 22302 K080991 K080797	MANG. INF. MANG. SUP. SERPENTIN SERPENTIN MANG. SUP. MANG. SUP. SERPENTIN SERPENTIN MANG. SUP. MANG. SUP. SERPENTIN SERPENTIN	S/AA S/AA S/AA C/AA S/AA S/AA S/AA S/AA S/AA S/AA S/AA
V-8, 5.4 L V-8, 4.6 L	2001 2000	352790(802) 353920(802) 38053 38023 38022 K080797 K080991 31109 31830 31406	EDH EDH POLEA POLEA POLEA LOCA SERPENTIN SERPENTIN TAPON DE ACEITE TAPON DE GASOLINA TAPON DE RADIADOR	PRESION CON HIDROBOOST PRESION S/AA  S/AA C/AA  SIN LLAVE REGULAR (16 lbs) Sin Palanca	V-8, 5.0 L	1997	CH-136623 CH-136502 K061020	MANG. INF. MANG. SUP. SERPENTIN	S/AA S/AA C/AA S/AA S/AA C/AA

**F-250 SUPER DUTY**

**F-250 XL**



V-8, 5.8 L	1997	CH-131282 K060990	MANG. SUP. SERPENTIN
------------	------	----------------------	-------------------------

38001	POLEA	
38023	POLEA	
38022	POLEA LOCA	
K060997	SERPENTIN	
31109	TAPON DE ACEITE	
31615	TAPON DE GASOLINA	SIN LLAVE C/CONT. DE EMIS
31406	TAPON DE RADIADOR	(16 lbs) Sin Palanca
38133	SENSOR MICRO-V	C/AA
38330	SENSOR MICRO-V	S/AA
33469	TERMOSTATO	195°F

### F-250 XLT

V-8, 4.6 L	2001	22298 22302 K080797 K080991	MANG. INF. MANG. SUP. SERPENTIN SERPENTIN	C/AA C/AA S/AA
V-8, 4.6 L	2000	22298 22302 K080797 K080991	MANG. INF. MANG. SUP. SERPENTIN SERPENTIN	C/AA C/AA S/AA
V-8, 4.6 L	1999	22298 22302 K080797 K080991	MANG. INF. MANG. SUP. SERPENTIN SERPENTIN	C/AA C/AA S/AA
V-8, 4.6 L	1998	22298 22302 K080991 K080797	MANG. INF. MANG. SUP. SERPENTIN SERPENTIN	C/AA C/AA C/AA S/AA
V-8, 5.0 L	1997	CH-136623 CH-136502 K060990	MANG. INF. MANG. SUP. SERPENTIN	
V-8, 5.8 L	1997	CH-131282 K060935 K061020	MANG. SUP. SERPENTIN SERPENTIN	PBV MAS DE 8500 MENOS DE 8500

V-8, 5.4 L

2005

V-8, 5.4 L

2004

### F-350 SUPER DUTY

V-8, 5.4 L	2010	38001 38006 K060806 K060990 K061005 38329 38274	POLEA POLEA DEL TENSOR SERPENTIN SERPENTIN SERPENTIN TENSOR TENSOR	SIN A.A. CON A.A. CON PAQ. AIRE AM CON A.A. SIN A.A. CON A.A.
V-8, 5.4 L	2009	23273 38001 38001 36157 K060806 K060997 31842 31841 31336 38329 38274 33469	MANGUERA SUP. POLEA POLEA POLEA SERPENTIN SERPENTIN TAPON DE GASOLINA TAPON DE GASOLINA TAPONES DE RADIADOR TENSOR TENSOR TERMOSTATOS	LISA RANURADA SIN A.A. CON A.A. CON LLAVE 16 LBS. 195°
V-8, 5.4 L	2008	23273 38001 36157 38001 K060997 K060806 31842 31841 31336 38274 38329 33469	MANGUERA SUP. POLEA POLEA POLEA SERPENTIN SERPENTIN TAPON DE GASOLINA TAPON DE GASOLINA TAPONES DE RADIADOR TENSOR TENSOR TERMOSTATOS	LISA RANURADA CON A.A. SIN A.A. CON LLAVE 16 LBS. 195°
V-8, 5.4 L	2007	23273 38001 36157 38001 K060806 K060997 31841 31842 31336 38274 38329 33469	MANGUERA SUP. POLEA POLEA POLEA SERPENTIN SERPENTIN TAPON DE GASOLINA TAPON DE GASOLINA TAPONES DE RADIADOR TENSOR TENSOR TERMOSTATOS	LISA RANURADA SIN A.A. CON A.A. CON LLAVE 16 LBS. 195°
V-8, 5.4 L	2006	352850(803) 22430 22429	EDH MANG. INF. MANG. SUP.	PRESION C/SIST. CONV.

V-8, 5.4 L











2003

V-8, 5.4 L

2002

V-8, 5.4 L

2001

    				    					
V-8, 5.4 L	2001	38133 33469	TENSOR MICRO-V TERMOSTATO	C/AA 195°F	V-10, 6.8 L	2009	38001 38006	POLEA POLEA DEL TENSOR	
V-8, 5.4 L	2000	352850(803) 22430 22429 38023 38022	EDH MANG. INF. MANG. SUP. POLEA POLEA LOCA	PRESION C/SIST. CONV.			K061005 K060806 K060990 31275 31109	SERPENTIN SERPENTIN SERPENTIN TAPON DE ACEITE TAPON DE ACEITE	CON A.A. SIN A.A. CON A.A. CON PAQ. AIRE AM SIN ROSCA CON ROSCA CON LLAVE
V-8, 5.4 L	1999	K080806 K081000 31109 31615 31406 38133 33469	SERPENTIN SERPENTIN TAPON DE ACEITE TAPON DE GASOLINA TAPON DE RADIADOR TENSOR MICRO-V TERMOSTATO	S/AA C/AA  SIN LLAVE C/CONT. DE EMIS (16 lbs) Sin Palanca C/AA 195°F	V-8, 6.4 L DIESEL	2009	36234 K080865 K080956 K060393 39051 39052	POLEA SERPENTIN SERPENTIN SERPENTIN TENSOR TENSOR	16 LBS. SIN A.A. CON A.A. 195° LISA
V-8, 5.4 L	1999	352850(803) 22430 22429 38023 38022	EDH MANG. INF. MANG. SUP. POLEA POLEA LOCA	PRESION C/SIST. CONV.			K080956 K060393 39051 39052	SERPENTIN SERPENTIN SERPENTIN TENSOR	
V-8, 5.8 L	1997	K081000 K080806 31109 31615 31406 38133 33469	SERPENTIN SERPENTIN TAPON DE ACEITE TAPON DE GASOLINA TAPON DE RADIADOR TENSOR MICRO-V TERMOSTATO	C/AA S/AA  SIN LLAVE C/CONT. DE EMIS (16 lbs) Sin Palanca C/AA 195°F	V-10, 6.8 L	2008	38001 38006 K060990 K061005 K060806 31275 31109	POLEA POLEA DEL TENSOR SERPENTIN SERPENTIN SERPENTIN TAPON DE ACEITE TAPON DE ACEITE	CON A.A. CON PAQ. AIRE AM CON A.A. SIN A.A. SIN ROSCA CON ROSCA
V-8, 5.8 L	1997	22143 38007 38006 K061020 31109 31615 31527 38123 33509	MANG. SUP. POLEA LOCA POLEA TENSORA SERPENTIN TAPON DE ACEITE TAPON DE GASOLINA TAPON DE RADIADOR TENSOR MICRO-V TERMOSTATO	C/ALT 60 A   SIN LLAVE C/CONT. DE EMIS (13 lbs) Sin palanca 195°F	V-8, 6.4 L DIESEL	2008	36234 K080865 K080956 K060393 39052 39051	POLEA SERPENTIN SERPENTIN SERPENTIN TENSOR TENSOR	CON LLAVE 16 LBS. SIN A.A. CON A.A. 195° LISA

### F-350 XL

V-8, 5.0 L	1998	CH-136623 CH-136502 21220	MANG. DE PASO MANG. INF. MANG. SUP.		V-10, 6.8 L	2007	23266 23275 36157 38001 38001	MANGUERA INF. MANGUERA SUP. POLEA POLEA POLEA	RANURADA LISA
V-8, 5.8 L	1998	K060990 CH-136623 CH-136502 CH-135581	SERPENTIN MANG. DE PASO MANG. INF. MANG. SUP.	S/AA			K060997 K060806 31842 31841	SERPENTIN SERPENTIN TAPON DE GASOLINA TAPON DE GASOLINA	CON A.A. SIN A.A. CON LLAVE
V-8, 5.0 L	1997	K061020 CH-136623 CH-136502 21220	SERPENTIN MANG. DE PASO MANG. INF. MANG. SUP.				31336 38329 38274 33469	TAPONES DE RADIADOR TENSOR TENSOR TERMOSTATOS	16 LBS. 195°
V-8, 5.8 L	1997	K060990 CH-136623 CH-136502 CH-135581 K061020	SERPENTIN MANG. DE PASO MANG. INF. MANG. SUP. SERPENTIN	S/AA	V-10, 6.8 L	2006	352860(803) 38023 38022 K060997	EDH POLEA POLEA LOCA SERPENTIN	PRESION C/SIST. CONV. C/AA

### F-450 SUPER DUTY

V-10, 6.8 L	2010	38001 38006 K060806 K061005 K060990 31275 31109 31841 31842 31336 38329 38274 33469	POLEA POLEA DEL TENSOR SERPENTIN SERPENTIN SERPENTIN TAPON DE ACEITE TAPON DE ACEITE TAPON DE GASOLINA TAPON DE GASOLINA TAPONES DE RADIADOR TENSOR TENSOR TERMOSTATOS	SIN A.A. CON A.A. CON A.A. CON PAQ. AIRE AM SIN ROSCA CON ROSCA  CON LLAVE 16 LBS. SIN A.A. CON A.A. 195° LISA	V-10, 6.8 L	2005	352860(803) 38023 38022 K060997 31109 31615 31406 38133 33469	EDH POLEA POLEA LOCA SERPENTIN TAPON DE ACEITE TAPON DE GASOLINA TAPON DE RADIADOR TENSOR MICRO-V TERMOSTATO	PRESION C/SIST. CONV. 195°F PRESION C/SIST. CONV.
V-8, 6.4 L DIESEL	2010	36234 K060393 K080956 K080865 39052 39051	POLEA SERPENTIN SERPENTIN SERPENTIN TENSOR TENSOR TENSOR		V-10, 6.8 L	2004	352860(803) 38023 38022 K081000 K080806 31109	EDH POLEA POLEA LOCA SERPENTIN SERPENTIN TAPON DE ACEITE	PRESION C/SIST. CONV. C/AA S/AA

V-10, 6.8 L	2004	31615	TAPON DE GASOLINA	SIN LLAVE C/CONT. DE EMIS		33469	TERMOSTATO	195°F	
		31406	TAPON DE RADIADOR	(16 lbs) Sin Palanca	V-8, 5.4 L	22430	MANG. INF.		
		38133	SENSOR MICRO-V			22429	MANG. SUP.		
		33469	TERMOSTATO	195°F		K081000	SERPENTIN	C/AA	
V-10, 6.8 L	2003	352860(803)	EDH	PRESION C/SIST. CONV.		K080806	SERPENTIN	S/AA	
		38023	POLEA		V-8, 7.3 L	22434	MANG. INF.		
		38022	POLEA LOCA			22433	MANG. SUP.		
		K081000	SERPENTIN	C/AA	V-10, 6.8 L	1999	352860(803)	EDH	PRESION C/SIST. CONV.
		K080806	SERPENTIN	S/AA		22431	MANG. SUP.		
		31109	TAPON DE ACEITE			38023	POLEA		
		31615	TAPON DE GASOLINA	SIN LLAVE C/CONT. DE EMIS		38022	POLEA LOCA		
		31406	TAPON DE RADIADOR	(16 lbs) Sin Palanca		K080806	SERPENTIN	S/AA	
		38133	SENSOR MICRO-V			K081000	SERPENTIN	C/AA	
		33469	TERMOSTATO	195°F		31109	TAPON DE ACEITE		
V-8, 7.3 L	2003	80321	EDH	PRESION C/SIST. CONV.		31615	TAPON DE GASOLINA	SIN LLAVE C/CONT. DE EMIS	
		22434	MANG. INF.			31406	TAPON DE RADIADOR	(16 lbs) Sin Palanca	
		22433	MANG. SUP.			38133	SENSOR MICRO-V		
		38053	POLEA	LISA		33469	TERMOSTATO	195°F	
		38028	POLEA		V-8, 5.4 L	22430	MANG. INF.		
		K081223	SERPENTIN	C/UN ALT. S/PAQUETE AMBU		22429	MANG. SUP.		
		31109	TAPON DE ACEITE			K081000	SERPENTIN	C/AA	
		31615	TAPON DE GASOLINA	SIN LLAVE C/CONT. DE EMIS		K080806	SERPENTIN	S/AA	
		31406	TAPON DE RADIADOR	(16 lbs) Sin Palanca	V-8, 7.3 L	1999	22434	MANG. INF.	
		38191	SENSOR MICRO-V			22433	MANG. SUP.		
		33909	TERMOSTATO	195°F	V-8, 7.5 L	1998	K060685	SERPENTIN	
V-10, 6.8 L	2002	352860(803)	EDH	PRESION C/SIST. CONV.	V-8, 7.5 L	1997	21909	MANG. INF.	
		38023	POLEA				21875	MANG. INF.	
		38022	POLEA LOCA				1517T200	MANG. SUP.	FLEXIBLE
		K080806	SERPENTIN	S/AA			21668	MANG. SUP.	
		K081000	SERPENTIN	C/AA			38001	POLEA	
		31109	TAPON DE ACEITE				K060685	SERPENTIN	
		31615	TAPON DE GASOLINA	SIN LLAVE C/CONT. DE EMIS			31109	TAPON DE ACEITE	
		31406	TAPON DE RADIADOR	(16 lbs) Sin Palanca			31615	TAPON DE GASOLINA	SIN LLAVE C/CONT. DE EMIS
		38133	SENSOR MICRO-V				31527	TAPON DE RADIADOR	(13 lbs) Sin palanca
		33469	TERMOSTATO	195°F			38140	SENSOR MICRO-V	
V-8, 7.3 L	2002	80321	EDH	PRESION C/SIST. CONV.			33509	TERMOSTATO	195°F
		22434	MANG. INF.			<b>F-550 SUPER DUTY</b>			
		22433	MANG. SUP.			2010	38001	POLEA	
		38028	POLEA	LISA	V-10, 6.8 L		38006	POLEA DEL TENSOR	
		38053	POLEA	C/UN ALT. S/PAQUETE AMBU			K061005	SERPENTIN	CON A.A.
		K081223	SERPENTIN				K060806	SERPENTIN	SIN A.A.
		31109	TAPON DE ACEITE	SIN LLAVE C/CONT. DE EMIS			K060990	SERPENTIN	CON A.A. CON PAQ. AIRE AM
		31615	TAPON DE GASOLINA	(16 lbs) Sin Palanca			31109	TAPON DE ACEITE	CON ROSCA
		31406	TAPON DE RADIADOR				31275	TAPON DE ACEITE	SIN ROSCA
		38191	SENSOR MICRO-V	195°F			31842	TAPON DE GASOLINA	CON LLAVE
		33909	TERMOSTATO	PRESION C/SIST. CONV.			31841	TAPON DE GASOLINA	
V-10, 6.8 L	2001	352860(803)	EDH				31336	TAPONES DE RADIADOR	16 LBS.
		38023	POLEA				38274	TENSOR	CON A.A.
		38022	POLEA LOCA				38329	TENSOR	SIN A.A.
		K081000	SERPENTIN	C/AA			33469	TERMOSTATOS	195°
		K080806	SERPENTIN	S/AA			36234	POLEA	LISA
		31109	TAPON DE ACEITE		V-8, 6.4 L DIESEL	2010	K080956	SERPENTIN	
		31615	TAPON DE GASOLINA	SIN LLAVE C/CONT. DE EMIS			K080865	SERPENTIN	
		31406	TAPON DE RADIADOR	(16 lbs) Sin Palanca			K060393	SERPENTIN	
		38133	SENSOR MICRO-V				39052	TENSOR	
		33469	TERMOSTATO	195°F			39051	TENSOR	
V-8, 7.3 L	2001	80321	EDH	PRESION C/SIST. CONV.			38001	POLEA	
		22434	MANG. INF.				38006	POLEA DEL TENSOR	
		22433	MANG. SUP.		V-10, 6.8 L	2009	K060806	SERPENTIN	SIN A.A.
		K081223	SERPENTIN	C/UN ALT. S/PAQUETE AMBU			K060990	SERPENTIN	CON A.A. CON PAQ. AIRE AM
		31109	TAPON DE ACEITE				K061005	SERPENTIN	CON A.A.
		31615	TAPON DE GASOLINA	SIN LLAVE C/CONT. DE EMIS			31109	TAPON DE ACEITE	CON ROSCA
		31406	TAPON DE RADIADOR	(16 lbs) Sin Palanca			31275	TAPON DE ACEITE	SIN ROSCA
		38133	SENSOR MICRO-V	195°F			31841	TAPON DE GASOLINA	
		33909	TERMOSTATO	PRESION C/SIST. CONV.			31842	TAPON DE GASOLINA	CON LLAVE
V-10, 6.8 L	2000	352860(803)	EDH				31336	TAPONES DE RADIADOR	16 LBS.
		22432	MANG. INF.				38274	TENSOR	CON A.A.
		22431	MANG. SUP.				38329	TENSOR	SIN A.A.
		38023	POLEA				33469	TERMOSTATOS	195°
		38022	POLEA LOCA				36234	POLEA	LISA
		K080806	SERPENTIN	S/AA			K080865	SERPENTIN	
		K081000	SERPENTIN	C/AA	V-8, 6.4 L DIESEL	2009	K080956	SERPENTIN	
		31109	TAPON DE ACEITE				K060393	SERPENTIN	
		31615	TAPON DE GASOLINA	SIN LLAVE C/CONT. DE EMIS					
		31406	TAPON DE RADIADOR	(16 lbs) Sin Palanca					
		38133	SENSOR MICRO-V						

V-8, 6.4 L DIESEL	2009	39051	TENSOR		K060413	SERPENTIN			SIN AA Y SIN DH
		39052	TENSOR		K060882	SERPENTIN			CON AA Y CON DH
V-10, 6.8 L	2008	38001	POLEA		K060856	SERPENTIN			CON AA Y SIN DH
		38006	POLEA DEL TENSOR		31615	TAPON DE GASOLINA			SIN LLAVE C/CONT. DE EMIS
		K060806	SERPENTIN	SIN A.A.	TMV13001	TENSOR			
		K061005	SERPENTIN	CON A.A.	33238	TERMOSTATOS			180°F
		K060990	SERPENTIN	CON A.A. CON PAQ. AIRE AM4 CIL, 1.6 L	2004	CH-130232	MANGUERA INF.		
		31109	TAPON DE ACEITE	CON ROSCA	CH-130292	MANGUERA INF.			
		31275	TAPON DE ACEITE	SIN ROSCA	CH-130221	MANGUERA SUP.			
		31841	TAPON DE GASOLINA		K060670	SERPENTIN			SIN AA Y CON DH
		31842	TAPON DE GASOLINA	CON LLAVE	K060882	SERPENTIN			C/AA, C/DH
		31336	TAPONES DE RADIADOR	16 LBS.	K060856	SERPENTIN			CON AA Y SIN DH
		38329	TENSOR	SIN A.A.	K060882	SERPENTIN			CON AA Y CON DH
		38274	TENSOR	CON A.A.	K060413	SERPENTIN			SIN AA Y SIN DH
		33469	TERMOSTATOS	195°	31615	TAPON DE GASOLINA			SIN LLAVE C/CONT. DE EMIS
V-8, 6.4 L DIESEL	2008	36234	POLEA	LISA	TMV13001	TENSOR			
		K080956	SERPENTIN		33238	TERMOSTATOS			180°F
		K060393	SERPENTIN		2003	8334GS	ALT.		
		K080865	SERPENTIN		T1086	BANDA ARBOL DE LEVAS			117 DIENTES X 22 MM
		39051	TENSOR		CH-130151	MANGUERA SUP.			
		39052	TENSOR		K060763	SERPENTIN			
					2003	CH-130232	MANGUERA INF.		
					CH-130292	MANGUERA INF.			
					CH-130221	MANGUERA SUP.			
					CH-130221	MANGUERA SUP.			
					K060413	SERPENTIN			SIN AA Y SIN DH
					K060670	SERPENTIN			SIN AA Y CON DH
					K060856	SERPENTIN			CON AA Y SIN DH
					K060882	SERPENTIN			C/AA, C/DH
					K060882	SERPENTIN			CON AA Y CON DH
					31615	TAPON DE GASOLINA			SIN LLAVE C/CONT. DE EMIS
					TMV13001	TENSOR			
					33238	TERMOSTATOS			180°F
					2002	8334GS	ALT.		
					T1086	BANDA ARBOL DE LEVAS			117 DIENTES X 22 MM
					CH-130151	MANGUERA SUP.			
					K060763	SERPENTIN			
					2002	TMV13001	TENSOR		
					33238	TERMOSTATO			180°F
					2001	8334GS	ALT.		
					T1086	BANDA ARBOL DE LEVAS			117 DIENTES X 22 MM
					CH-130151	MANGUERA SUP.			
					K060763	SERPENTIN			
					2001	TMV13001	TENSOR		
					33238	TERMOSTATO			180°F
					2000	8334GS	ALT.		
					T1086	BANDA ARBOL DE LEVAS			117 DIENTES X 22 MM
					CH-130151	MANGUERA SUP.			
					K060763	SERPENTIN			
					2000	TMV13001	TENSOR		
					33238	TERMOSTATO			180°F
					1999	8334GS	ALT.		
					T1086	BANDA ARBOL DE LEVAS			117 DIENTES X 22 MM
					CH-130151	MANGUERA SUP.			
					K060763	SERPENTIN			

**FIESTA**











4 CIL, 1.6 L	2011	91030	HERRAMIENTA INST. STRECH F						
		6PK1019SF	SERPENTIN						
4 CIL, 1.6 L	2010	CH-130292	MANGUERA INF.						
		CH-130232	MANGUERA INF.						
		CH-130221	MANGUERA SUP.						
		K060856	SERPENTIN	CON A.A. Y SIN D.H					
		K060882	SERPENTIN	CON A.A. Y CON D.H.					
		K060670	SERPENTIN	SIN A.A. Y CON D.H.					
		K060413	SERPENTIN	SIN A.A. Y SIN D.H.					
		TMV13001	TENSOR						
		33238	TERMOSTATOS	180°		4 CIL, 1.4 L	2002	8334GS	ALT.
4 CIL, 1.6 L	2009	CH-130232	MANGUERA INF.						
		CH-130292	MANGUERA INF.						
		CH-130221	MANGUERA SUP.						
		K060856	SERPENTIN	CON A.A. Y SIN D.H					
		K060413	SERPENTIN	SIN A.A. Y SIN D.H.					
		K060670	SERPENTIN	SIN A.A. Y CON D.H.					
		K060882	SERPENTIN	CON A.A. Y CON D.H.					
		TMV13001	TENSOR						
		33238	TERMOSTATOS	180°		4 CIL, 1.6 L	2001	8334GS	ALT.
4 CIL, 1.6 L	2008	CH-130232	MANGUERA INF.						
		CH-130292	MANGUERA INF.						
		CH-130221	MANGUERA SUP.						
		K060882	SERPENTIN	CON AA Y CON DH					
		K060856	SERPENTIN	CON AA Y SIN DH					
		K060413	SERPENTIN	SIN AA Y SIN DH					
		K060670	SERPENTIN	SIN AA Y CON DH					
		TMV13001	TENSOR						
		33238	TERMOSTATOS	180°F		4 CIL, 1.4 L	1999	8334GS	ALT.
4 CIL, 1.6 L	2007	CH-130232	MANGUERA INF.						
		CH-130292	MANGUERA INF.						
		CH-130221	MANGUERA SUP.						
		K060413	SERPENTIN	SIN AA Y SIN DH					
		K060882	SERPENTIN	CON AA Y CON DH					
		K060670	SERPENTIN	SIN AA Y CON DH					
		K060856	SERPENTIN	CON AA Y SIN DH					
		TMV13001	TENSOR						
		33238	TERMOSTATOS	180°F					
4 CIL, 1.6 L	2006	CH-130232	MANGUERA INF.						
		CH-130292	MANGUERA INF.						
		CH-130221	MANGUERA SUP.						
		K060882	SERPENTIN	CON AA Y CON DH					
		K060413	SERPENTIN	SIN AA Y SIN DH					
		K060670	SERPENTIN	SIN AA Y CON DH					
		K060856	SERPENTIN	CON AA Y SIN DH					
		TMV13001	TENSOR						
		33238	TERMOSTATOS	180°F					
4 CIL, 1.6 L	2005	CH-130232	MANGUERA INF.						
		CH-130292	MANGUERA INF.						
		CH-130221	MANGUERA SUP.						
		K060670	SERPENTIN	SIN AA Y CON DH					

**FIVE HUNDRED**

					V-6, 3.0 L	2007	23169	MANG. INF.	RADIADOR/TUBO
							23167	MANG. INF.	TUBO/TERMOSTATO
							23177	MANG. SUP.	
							K060840	SERPENTIN	
							31275	TAPON DE ACEITE	
							31841	TAPON DE GASOLINA	SIN LLAVE REGULAR
							31406	TAPON DE RADIADOR	(16 lbs) Sin Palanca
							38279	TENSOR MICRO-V	
							33238	TERMOSTATO	180°F
					V-6, 3.0 L	2006	23177	MANG. SUP.	
							K060840	SERPENTIN	
							31275	TAPON DE ACEITE	
							31841	TAPON DE GASOLINA	SIN LLAVE REGULAR
							31406	TAPON DE RADIADOR	(16 lbs) Sin Palanca
							38279	TENSOR MICRO-V	
							33238	TERMOSTATO	180°F
					V-6, 3.0 L	2005	K060840	SERPENTIN	
							31275	TAPON DE ACEITE	





    				    				
4 CIL, 2.0 L	2001	92008	EDH	PREISION SOHC	K060960	SERPENTIN	C/AA	
		22500	INF. - RADIADOR A TUBO	SOHC		31109	TAPON DE ACEITE	
		22501	INF. - TUBO A BA	SOHC		31841	TAPON DE GASOLINA	SIN LLAVE REGULAR
		TCK294A	KIT DE DISTRIBUCION	2000 - 2006 T42036		31842	TAPON DE GASOLINA	CON LLAVE REGULAR
		TCK283	KIT DE DISTRIBUCION	SOHC		31406	TAPON DE RADIADOR	(16 lbs) Sin Palanca
		22504	MANGUERA INF.	DOHC		33469	TERMOSTATO	195°F
		22502	MANGUERA SUP.	DOHC		19805	MANG. DE CALEFACCION	
		22503	MANGUERA SUP.	SOHC		22448	MANG. INF.	
		38008	POLEA			K060960	SERPENTIN	C/AA
		T42034	POLEA BANDA DE TIEMPO	INFERIOR		31109	TAPON DE ACEITE	
		T42036	POLEA BANDA DE TIEMPO	SUPERIOR		31842	TAPON DE GASOLINA	CON LLAVE REGULAR
		38018	POLEA LOCA	DOHC		31841	TAPON DE GASOLINA	SIN LLAVE REGULAR
		K060837	SERPENTIN	C/AA, C/DH		31406	TAPON DE RADIADOR	(16 lbs) Sin Palanca
		K060532	SERPENTIN	SOHC; S/AA		33469	TERMOSTATO	195°F
		K060680	SERPENTIN	SOHC; C/AA		22448	MANG. INF.	
		K060680	SERPENTIN	SOHC; C/AA		K060960	SERPENTIN	C/AA
		K060775	SERPENTIN	S/AA, C/DH		31109	TAPON DE ACEITE	
		K060763	SERPENTIN	S/AA, C/DH		31842	TAPON DE GASOLINA	CON LLAVE REGULAR
		K060710	SERPENTIN	C/AA, C/DH		31841	TAPON DE GASOLINA	SIN LLAVE REGULAR
		31275	TAPON DE ACEITE			31406	TAPON DE RADIADOR	(16 lbs) Sin Palanca
31637	TAPON DE GASOLINA		38150	SENSOR MICRO-V				
31530	TAPON DE RADIADOR	SIN LLAVE REGULAR	33469	TERMOSTATO	195°F			
T43004	SENSOR ARBOL DE LEVAS	(18 lbs) Sin Palanca	22448	MANG. INF.				
T43003	SENSOR ARBOL DE LEVAS		K060960	SERPENTIN	C/AA			
38275	SENSOR MICRO-V		31109	TAPON DE ACEITE				
38188	SENSOR MICRO-V		31842	TAPON DE GASOLINA	CON LLAVE REGULAR			
33339	TERMOSTATO	195°F	31841	TAPON DE GASOLINA	SIN LLAVE REGULAR			
19154	TUBO-1 A CALEF.	DOHC	31406	TAPON DE RADIADOR	(16 lbs) Sin Palanca			
4 CIL, 2.0 L	2000	T283	BANDA ARBOL DE LEVAS		38150	SENSOR MICRO-V		
		T294	BANDA ARBOL DE LEVAS	{129 D x 25.4 mm}	33469	TERMOSTATO	195°F	
		19746	CALEF. A BA	SOHC	22448	MANG. INF.		
		22570	CALEF. A MOTOR	SOHC	K060960	SERPENTIN	C/AA	
		91998	EDH	PREISION SOHC	31109	TAPON DE ACEITE		
		22501	INF. - TUBO A BA	SOHC	31842	TAPON DE GASOLINA	CON LLAVE REGULAR	
		TCK294A	KIT DE DISTRIBUCION	2000 - 2006 T42036	31406	TAPON DE RADIADOR	(16 lbs) Sin Palanca	
		TCK283	KIT DE DISTRIBUCION	SOHC	38150	SENSOR MICRO-V		
		22504	MANGUERA INF.	DOHC	33469	TERMOSTATO	195°F	
		22500	MANGUERA INF.	C/AA, C/DH	22448	MANGUERA INF.		
		22503	MANGUERA SUP.	SOHC	K060960	SERPENTIN	C/AA	
		22502	MANGUERA SUP.	DOHC	31109	TAPON DE ACEITE		
		38008	POLEA		31841	TAPON DE GASOLINA	SIN LLAVE REGULAR	
		T42036	POLEA BANDA DE TIEMPO	SUPERIOR	31842	TAPON DE GASOLINA	CON LLAVE REGULAR	
		T42034	POLEA BANDA DE TIEMPO	INFERIOR	31406	TAPON DE RADIADOR	(16 lbs) Sin Palanca	
		38018	POLEA LOCA	DOHC	38150	SENSOR MICRO-V		
		K060710	SERPENTIN	SOHC; C/AA	33469	TERMOSTATO	195°F	
		K060775	SERPENTIN	S/AA, DOHC				
		K060532	SERPENTIN	SOHC; S/AA				
		K060837	SERPENTIN	DOHC; C/AA				
31275	TAPON DE ACEITE							
31637	TAPON DE GASOLINA	SIN LLAVE REGULAR						
31530	TAPON DE RADIADOR	(18 lbs) Sin Palanca						
T43003	SENSOR ARBOL DE LEVAS							
T43004	SENSOR ARBOL DE LEVAS							
38275	SENSOR MICRO-V							
38188	SENSOR MICRO-V							
33339	TERMOSTATO	195°F						
19154	TUBO-1 A CALEF.	DOHC						
<b>FUSION</b>								
V-6, 3.9 L	2007	22448	MANG. INF.	V-6, 3.0 L	2010	K060868	SERPENTIN	
		K060960	SERPENTIN		2010	K060448	SENSOR	
		31109	TAPON DE ACEITE	V-6, 3.5 L	2010	K040352SF	D.H. STRECH FIT	
		31842	TAPON DE GASOLINA			91030	HERRAMIENTA INST. STRECH F	
		31406	TAPON DE RADIADOR			K060448	SERPENTIN	
		33469	TERMOSTATO			23443	MANGUERA SUP.	
		19805	MANG. DE CALEFACCION			K060882	SERPENTIN	T. AUTOMATICA
		22448	MANG. INF.			K060883	SERPENTIN	T. MANUAL
		K060960	SERPENTIN			38339	SENSOR	T. MANUAL
		31109	TAPON DE ACEITE			38452	SENSOR	T. AUTOMATICA
V-6, 4.2 L	2007	31842	TAPON DE GASOLINA	4 CIL, 2.3 L	2009	34044	TERMOSTATOS	180°
		31406	TAPON DE RADIADOR			K030195SF	B.A. STRECH FIT	
		33469	TERMOSTATO			91030	HERRAMIENTA INST. STRECH F	
		19805	MANG. DE CALEFACCION			38006	POLEA	LISA
		22448	MANG. INF.			38008	POLEA	RANURADA
		K060960	SERPENTIN			K060919	SERPENTIN	
		31109	TAPON DE ACEITE			31842	TAPON DE GASOLINA	CON LLAVE
		31842	TAPON DE GASOLINA			31841	TAPON DE GASOLINA	
		31406	TAPON DE RADIADOR			31406	TAPONES DE RADIADOR	16 LBS.
		33469	TERMOSTATO			38279	SENSOR	
V-6, 3.9 L	2006	19805	MANG. DE CALEFACCION	4 CIL, 2.3 L	2008	33238	TERMOSTATOS	180°
		22448	MANG. INF.			23443	MANGUERA SUP.	
						K060882	SERPENTIN	T. AUTOMATICA
						K060883	SERPENTIN	T. MANUAL
						K060891	SERPENTIN	
						31295	TAPON DE ACEITE	

**FREESTAR**

V-6, 3.9 L	2007	22448	MANG. INF.	
		K060960	SERPENTIN	C/AA
		31109	TAPON DE ACEITE	
		31842	TAPON DE GASOLINA	CON LLAVE REGULAR
		31406	TAPON DE RADIADOR	(16 lbs) Sin Palanca
		33469	TERMOSTATO	195°F
		19805	MANG. DE CALEFACCION	
		22448	MANG. INF.	
		K060960	SERPENTIN	C/AA
		31109	TAPON DE ACEITE	
V-6, 4.2 L	2007	31842	TAPON DE GASOLINA	CON LLAVE REGULAR
		31406	TAPON DE RADIADOR	(16 lbs) Sin Palanca
		33469	TERMOSTATO	195°F
		19805	MANG. DE CALEFACCION	
		22448	MANG. INF.	
		K060960	SERPENTIN	C/AA
		31109	TAPON DE ACEITE	
		31842	TAPON DE GASOLINA	CON LLAVE REGULAR
		31406	TAPON DE RADIADOR	(16 lbs) Sin Palanca
		33469	TERMOSTATO	195°F
V-6, 3.9 L	2006	19805	MANG. DE CALEFACCION	
		22448	MANG. INF.	

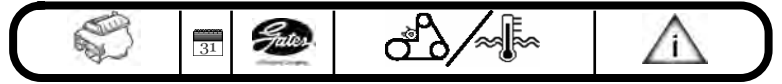

4 CIL, 2.3 L	2008	31842 31841 31406 38452 38339 34044	TAPON DE GASOLINA TAPON DE GASOLINA TAPON DE RADIADOR TENSOR TENSOR TERMOSTATO	CON LLAVE  16 LIBRAS T. AUTOMATICA T. MANUAL 180°F
V-6, 3.0 L	2008	K030195SF 91030 38006 38008 K060919 31275 31842 31841 31406 38279 33248	B.A. STRECH FIT HERRAMIENTA INST. STRECH F POLEA POLEA SERPENTIN TAPON DE ACEITE TAPON DE GASOLINA TAPON DE GASOLINA TAPON DE RADIADOR TENSOR MICRO-V TERMOSTATO	
4 CIL, 2.3 L	2007	23443 K060883 K060882 K060891 31295 31842 31841 31406 38452 38339 34044	MANGUERA SUP. SERPENTIN SERPENTIN SERPENTIN TAPON DE ACEITE TAPON DE GASOLINA TAPON DE GASOLINA TAPON DE RADIADOR TENSOR TENSOR TERMOSTATO	T. MANUAL T.AUTOMATICA  CON LLAVE 16 LIBRAS T. AUTOMATICA T. MANUAL 180°F
V-6, 3.0 L	2007	K030195SF 91030 38006 38008 K060919 31275 31842 31841 31406 38279 33248	B.A. STRECH FIT HERRAMIENTA INST. STRECH F POLEA POLEA SERPENTIN TAPON DE ACEITE TAPON DE GASOLINA TAPON DE GASOLINA TAPON DE RADIADOR TENSOR MICRO-V TERMOSTATO	16 LIBRAS   188 ° F

2000	TMV-13001 33238	TENSOR MICRO-V TERMOSTATO	180°F
------	--------------------	------------------------------	-------

**KA**











4 CIL, 1.6 L	2007	CH-130132 CH-130142 CH-130121 K060882 K060670 TMV13001 33238	MANGUERA INF. MANGUERA INF. MANGUERA SUP. SERPENTIN SERPENTIN TENSOR TERMOSTATOS	CON A.A. SIN A.A.  180°
4 CIL, 1.6 L	2006	CH-130132 CH-130142 CH-130121 K060882 K060670 33238	MANGUERA INF. MANGUERA INF. MANGUERA SUP. SERPENTIN SERPENTIN TERMOSTATO	MOTOR A TUBO TUBO A RADIADOR  CON A.A. SIN A.A. 180°F
4 CIL, 1.6 L	2005	CH-130132 CH-130142 CH-130121 36136 K060882 K060670 TMV-13001 33238	MANG. INF. MANGUERA INF. MANGUERA SUP. POLEA SERPENTIN SERPENTIN TENSOR MICRO-V TERMOSTATO	TUBO A RADIADOR      180°F
4 CIL, 1.6 L	2004	CH-130132 CH-130142 CH-130121 K060882 K060670 TMV-13001 33238	MANGUERA INF. MANGUERA INF. MANGUERA SUP. SERPENTIN SERPENTIN TENSOR MICRO-V TERMOSTATO	TUBO A RADIADOR   C/AA, C/DH S/AA, C/DH  180°F
4 CIL, 1.6 L	2003	CH-130142 CH-130132 CH-130121 K060670 K060882 K060856 K060413 TMV-13001 33238	MANGUERA INF. MANGUERA INF. MANGUERA SUP. SERPENTIN SERPENTIN SERPENTIN SERPENTIN TENSOR MICRO-V TERMOSTATO	TUBO A RADIADOR   S/AA, C/DH C/AA, C/DH C/AA, S/DH S/AA, S/DH  180°F
4 CIL, 1.6 L	2002	CH-130132 CH-130142 CH-130121 K060413 K060670 K060882 K060856 TMV-13001 33238	INF. - MOTOR A TUBO INF. - TUBO A RADIADOR MANGUERA SUP. SERPENTIN SERPENTIN SERPENTIN SERPENTIN TENSOR MICRO-V TERMOSTATO	SIN AA Y CON DH CON AA Y CON DH CON AA Y SIN DH    180°F
4 CIL, 1.6 L	2001	CH-130132 CH-130142 CH-130121 K060670 K060856 K060882 K060413 TMV-13001 33238	INF. - MOTOR A TUBO INF. - TUBO A RADIADOR MANGUERA SUP. SERPENTIN SERPENTIN SERPENTIN SERPENTIN TENSOR MICRO-V TERMOSTATO	SIN AA Y CON DH CON AA Y SIN DH CON AA Y CON DH    180°F

**IKON**

4 CIL, 1.6 L	2007	CH-130241 K060882 K060670 TMV13001 33238	MANGUERA SUP. SERPENTIN SERPENTIN TENSOR TERMOSTATOS	CON A.A. SIN A.A.  180°
4 CIL, 1.6 L	2006	CH-130241 K060670 K060882 33238	MANGUERA SUP. SERPENTIN SERPENTIN TERMOSTATO	SIN A.A. CON A.A. 180°F
4 CIL, 1.6 L	2005	CH-130241 K060882 K060670 TMV-13001 33238	MANGUERA SUP. SERPENTIN SERPENTIN TENSOR MICRO-V TERMOSTATO	180°F
4 CIL, 1.6 L	2004	CH-130241 K060882 K060670 TMV-13001 33238	MANGUERA SUP. SERPENTIN SERPENTIN TENSOR MICRO-V TERMOSTATO	C/AA, C/DH S/AA, C/DH  180°F
4 CIL, 1.6 L	2003	CH-130241 K060882 K060413 K060670 TMV-13001 33238	MANGUERA SUP. SERPENTIN SERPENTIN SERPENTIN TENSOR MICRO-V TERMOSTATO	C/AA, C/DH S/AA, S/DH S/AA, C/DH  180°F
4 CIL, 1.6 L	2002	CH-130241 K060882 K060670 K0604413 TMV-13001 33238	MANGUERA SUP. SERPENTIN SERPENTIN SERPENTIN TENSOR MICRO-V TERMOSTATO	C/AA, C/DH SIN AA Y CON DH SIN AA Y SIN DH  180°F
4 CIL, 1.6 L	2001	TMV-13001 33238	TENSOR MICRO-V TERMOSTATO	180°F

**LOBO**

V-8, 4.6 L	2010	38001 36157 K061025 31841 31842 31336 38274 33469	POLEA POLEA SERPENTIN TAPON DE GASOLINA TAPON DE GASOLINA TAPONES DE RADIADOR TENSOR TERMOSTATOS	LISA RANURADA CON A.A.  CON LLAVE 16 LBS. CON A.A. 195°
V-8, 5.4 L	2010	36157 38001 K061025 31841 31842	POLEA POLEA SERPENTIN TAPON DE GASOLINA TAPON DE GASOLINA	RANURADA LISA CON A.A.  CON LLAVE

    				    			
V-8, 5.4 L	2010	31336 TAPONES DE RADIADOR 38274 TENSOR 33469 TERMOSTATOS	16 LBS. CON A.A. 195°			38329 TENSOR MICRO-V 38274 TENSOR MICRO-V 33469 TERMOSTATO	S/AA C/AA 195°F
V-8, 4.6 L	2009	38001 POLEA 36157 POLEA K061025 SERPENTIN 31842 TAPON DE GASOLINA 31841 TAPON DE GASOLINA 31336 TAPONES DE RADIADOR 38274 TENSOR 33469 TERMOSTATOS	LISA RANURADA CON A.A. CON LLAVE 16 LBS. CON A.A. 195°	V-8, 4.6 L	2005	22859 MANG. INF. 22863 MANG. SUP. 38001 POLEA K061025 SERPENTIN 31109 TAPON DE ACEITE 31830 TAPON DE GASOLINA 31406 TAPON DE RADIADOR 38274 TENSOR MICRO-V 38329 TENSOR MICRO-V 33469 TERMOSTATO	LISA RANURADA C/AA S/AA SIN LLAVE REGULAR (16 lbs) Sin Palanca C/AA S/AA
V-8, 5.4 L	2009	36157 POLEA 38001 POLEA K061025 SERPENTIN 31842 TAPON DE GASOLINA 31841 TAPON DE GASOLINA 31336 TAPONES DE RADIADOR 38274 TENSOR 33469 TERMOSTATOS	RANURADA LISA CON A.A. CON LLAVE 16 LBS. CON A.A. 195°	V-8, 5.4 L	2005	22859 MANG. INF. 22863 MANG. SUP. 36157 POLEA 38001 POLEA K061025 SERPENTIN K060840 SERPENTIN 31109 TAPON DE ACEITE 31830 TAPON DE GASOLINA 31406 TAPON DE RADIADOR 38329 TENSOR MICRO-V 38274 TENSOR MICRO-V 33469 TERMOSTATO	SIN LLAVE REGULAR (16 lbs) Sin Palanca C/AA S/AA 195°F
V-8, 4.6 L	2008	22859 MANGUERA INF. 22863 MANGUERA SUP. 38001 POLEA 36157 POLEA K060840 SERPENTIN K061025 SERPENTIN 38274 TENSOR 38329 TENSOR	LISA RANURADA SIN A.A. CON A.A. CON A.A. SIN A.A.	V-8, 4.6 L	2004	K060832 SERPENTIN 31841 TAPON DE GASOLINA 31406 TAPON DE RADIADOR 33469 TERMOSTATO K060832 SERPENTIN 31275 TAPON DE ACEITE 31841 TAPON DE GASOLINA 31406 TAPON DE RADIADOR 33469 TERMOSTATO K060990 SERPENTIN K060802 SERPENTIN 31830 TAPON DE GASOLINA 31406 TAPON DE RADIADOR 33469 TERMOSTATO	RANURADA LISA C/AA S/AA SIN LLAVE REGULAR (16 lbs) Sin Palanca S/AA C/AA 195°F S/AA
V-8, 5.4 L	2008	22859 MANGUERA INF. 22863 MANGUERA SUP. 38001 POLEA 36157 POLEA K060840 SERPENTIN K061025 SERPENTIN 38329 TENSOR 38274 TENSOR	LISA RANURADA SIN A.A. CON A.A. SIN A.A. CON A.A.	V-8, 5.4 L	2004	K060832 SERPENTIN 31841 TAPON DE GASOLINA 31406 TAPON DE RADIADOR 33469 TERMOSTATO K060832 SERPENTIN 31275 TAPON DE ACEITE 31841 TAPON DE GASOLINA 31406 TAPON DE RADIADOR 33469 TERMOSTATO K060990 SERPENTIN K060802 SERPENTIN 31830 TAPON DE GASOLINA 31406 TAPON DE RADIADOR 33469 TERMOSTATO	S/AA S/AA SIN LLAVE REGULAR (16 lbs) Sin Palanca S/AA S/AA SIN LLAVE REGULAR (16 lbs) Sin Palanca 195°F S/AA
V-8, 4.6 L	2007	K061031 SERPENTIN 31109 TAPON DE ACEITE 31830 TAPON DE GASOLINA 31406 TAPON DE RADIADOR 38274 TENSOR MICRO-V 38329 TENSOR MICRO-V 33469 TERMOSTATO	SIN LLAVE REGULAR (16 lbs) Sin Palanca C/AA S/AA 195°F	V-8, 4.6 L	2003	353920(802) EDH 22298 MANGUERA INF. 22297 MANGUERA INF. 22302 MANGUERA SUP. K060990 SERPENTIN K080991 SERPENTIN K060802 SERPENTIN 31109 TAPON DE ACEITE 31615 TAPON DE GASOLINA 31406 TAPON DE RADIADOR 33469 TERMOSTATO	SIN LLAVE REGULAR (16 lbs) Sin Palanca C/AA S/AA 195°F PRESION C/4WD C/2WD 4X2 Y 4X4 C/AA MODELO LIGHTNING S/AA
V-8, 5.4 L	2007	22859 MANG. INF. 22863 MANG. SUP. 36157 POLEA 38001 POLEA K061025 SERPENTIN K060840 SERPENTIN 31109 TAPON DE ACEITE 31830 TAPON DE GASOLINA 31406 TAPON DE RADIADOR 38329 TENSOR MICRO-V 38274 TENSOR MICRO-V 33469 TERMOSTATO	RANURADA LISA C/AA S/AA SIN LLAVE REGULAR (16 lbs) Sin Palanca S/AA C/AA 195°F	V-8, 5.4 L	2003	353920(802) EDH K060990 SERPENTIN 31109 TAPON DE ACEITE 31830 TAPON DE GASOLINA 31406 TAPON DE RADIADOR 33469 TERMOSTATO	PRESION C/4WD C/2WD 4X2 Y 4X4 C/AA MODELO LIGHTNING S/AA SIN LLAVE C/CONT. DE EMIS (16 lbs) Sin Palanca 195°F PRESION C/AA
V-8, 4.6 L	2006	22859 MANG. INF. 22863 MANG. SUP. 36157 POLEA 38001 POLEA K061025 SERPENTIN K060840 SERPENTIN 31109 TAPON DE ACEITE 31830 TAPON DE GASOLINA 31406 TAPON DE RADIADOR 38329 TENSOR MICRO-V 38274 TENSOR MICRO-V 33469 TERMOSTATO	RANURADA LISA C/AA S/AA SIN LLAVE REGULAR (16 lbs) Sin Palanca S/AA C/AA 195°F	V-8, 4.6 L	2002	353920(802) EDH K060990 SERPENTIN 31109 TAPON DE ACEITE 31830 TAPON DE GASOLINA 31406 TAPON DE RADIADOR 38274 TENSOR MICRO-V 33469 TERMOSTATO	SIN LLAVE REGULAR (16 lbs) Sin Palanca A.A. 195°F
V-8, 4.6 L	2006	22859 MANG. INF. 22863 MANG. SUP. 36157 POLEA 38001 POLEA K061025 SERPENTIN K060840 SERPENTIN 31109 TAPON DE ACEITE 31830 TAPON DE GASOLINA 31406 TAPON DE RADIADOR 38329 TENSOR MICRO-V 38274 TENSOR MICRO-V 33469 TERMOSTATO	RANURADA LISA C/AA S/AA SIN LLAVE REGULAR (16 lbs) Sin Palanca S/AA C/AA 195°F	V-8, 5.4 L	2002	19199 CALEF. A MULTIPLE 19219 CALEF. A MULTIPLE 19193 CALEF. A TUBO-1 22298 MANGUERA INF. 22297 MANGUERA INF. 22302 MANGUERA SUP. 38023 POLEA DEL TENSOR 38022 POLEA LOCA K080660 SERPENTIN K080797 SERPENTIN K080991 SERPENTIN 35B 3/8" TANQUE DE RECUP. A RADIAD 38133 TENSOR MICRO-V 22298 MANGUERA INF. 22302 MANGUERA SUP. K080991 SERPENTIN	Reusar el restrictor de flujo orig Re-use existing flow restrictor; i S/SVT Pkg.; Exc. Lightning C/4WD - doble tracción C/2WD LISA SUPERCARGADOR S/AA C/AA C/SVT C/AA C/AA
V-8, 5.4 L	2006	22859 MANG. INF. 22863 MANG. SUP. 36157 POLEA 38001 POLEA K061025 SERPENTIN K060840 SERPENTIN 31109 TAPON DE ACEITE 31830 TAPON DE GASOLINA 31406 TAPON DE RADIADOR	RANURADA LISA C/AA S/AA SIN LLAVE REGULAR (16 lbs) Sin Palanca	V-8, 4.6 L	2000	22298 MANGUERA INF. 22302 MANGUERA SUP. K080991 SERPENTIN	C/AA



V-8, 4.6 L	2000	K080797	SERPENTIN	S/AA	V-8, 4.6 L	2009	33079	TERMOSTATOS	195°
V-8, 4.6 L	1999	22298	MANGUERA INF.				23367	MANGUERA INF.	TERMOSTATO AL MOTOR SL
		22302	MANGUERA SUP.				23054	MANGUERA INF.	TERMOSTATO AL MOTOR INI
		K080991	SERPENTIN	C/AA			36157	POLEA	RANURADA
V-8, 4.6 L	1998	K080797	SERPENTIN	S/AA			38001	POLEA	LISA
		22298	MANGUERA INF.				38006	POLEA DEL TENSOR	
		22302	MANGUERA SUP.				K061020	SERPENTIN	
		K080991	SERPENTIN	C/AA			31275	TAPON DE ACEITE	
V-8, 4.6 L	1997	K080797	SERPENTIN	S/AA			31841	TAPON DE GASOLINA	
		22298	MANGUERA INF.				31842	TAPON DE GASOLINA	CON LLAVE
		22302	MANGUERA SUP.				31406	TAPONES DE RADIADOR	16 LBS.
		K080991	SERPENTIN	C/AA			38274	TENSOR	
		K080797	SERPENTIN	S/AA			33469	TERMOSTATOS	195°

**MONDEO**

4 CIL, 2.0 L	2006	CH-139402	MANGUERA INF.		V-6, 4.0 L	2008	22038	MANGUERA DE PASO	
		CH-139401	MANGUERA SUP.				23050	MANGUERA SUP.	
		K060878	SERPENTIN				38001	POLEA	
		38204	TENSOR				K060875	SERPENTIN	
V-6, 2.5 L	2006	CH-139412	MANGUERA INF.				31842	TAPON DE GASOLINA	CON LLAVE
		22180	MANGUERA SUP.				31841	TAPON DE GASOLINA	
		K060820	SERPENTIN	ALTERNADOR	V-8, 4.6 L	2008	31406	TAPONES DE RADIADOR	16 LBS.
		K030267	SERPENTIN	BOMBA DE AGUA			38416	TENSOR	
4 CIL, 2.0 L	2005	CH-139402	MANGUERA INF.				33079	TERMOSTATOS	195°
		CH-139401	MANGUERA SUP.				23367	MANGUERA INF.	TERMOSTATO AL MOTOR SL
		K060878	SERPENTIN				23054	MANGUERA INF.	TERMOSTATO AL MOTOR INI
		38204	TENSOR				36157	POLEA	RANURADA
V-6, 2.5 L	2005	CH-139412	MANGUERA INF.				38001	POLEA	LISA
		22180	MANGUERA SUP.				38006	POLEA DEL TENSOR	
		K030267	SERPENTIN	BOMBA DE AGUA			K061020	SERPENTIN	
		K060820	SERPENTIN	ALTERNADOR			31275	TAPON DE ACEITE	
4 CIL, 2.0 L	2004	CH-139402	MANGUERA INF.				31841	TAPON DE GASOLINA	
		CH-139401	MANGUERA SUP.				31842	TAPON DE GASOLINA	CON LLAVE
		K060878	SERPENTIN				31406	TAPONES DE RADIADOR	16 LBS.
		38204	TENSOR				38274	TENSOR	
V-6, 2.5 L	2004	CH-139412	MANGUERA INF.		V-6, 4.0 L	2007	33469	TERMOSTATOS	195°
		22180	MANGUERA SUP.				23050	MANG. SUP.	
		K030267	SERPENTIN	BOMBA DE AGUA			38001	POLEA LOCA	
		K060820	SERPENTIN	ALTERNADOR			K060875	SERPENTIN	
4 CIL, 2.0 L	2003	CH-139402	MANGUERA INF.				31275	TAPON DE ACEITE	
		22788	MANGUERA INF.				31841	TAPON DE GASOLINA	SIN LLAVE REGULAR
		CH-139401	MANGUERA SUP.		V-8, 4.6 L	2007	33078	TERMOSTATO	180°F
		K060910	SERPENTIN	C/ ENFRIADOR DE ACEITE			23055	MANG. INF.	
		K060878	SERPENTIN				23054	MANG. INF.	
		38204	TENSOR				23053	MANG. SUP.	
V-6, 2.5 L	2003	CH-139412	MANGUERA INF.				36157	POLEA	
		22788	MANGUERA INF.				38001	POLEA LOCA	2PIEZAS
		22180	MANGUERA SUP.				K061015	SERPENTIN	
		K060910	SERPENTIN	C/ ENFRIADOR DE ACEITE			31275	TAPON DE ACEITE	
		K060815	SERPENTIN				31841	TAPON DE GASOLINA	SIN LLAVE REGULAR
		K030267	SERPENTIN		V-6, 4.0 L	2006	31406	TAPON DE RADIADOR	(16 lbs) Sin Palanca
		K060820	SERPENTIN	BOMBA DE AGUA			38274	TENSOR MICRO-V	
				ALTERNADOR			23050	MANG. SUP.	

**MUSTANG**

V-6, 4.0 L	2010	38001	POLEA		V-8, 4.6 L	2006	33078	TERMOSTATO	180°F
		K060875	SERPENTIN				23054	MANG. INF.	
		31842	TAPON DE GASOLINA	CON LLAVE			23055	MANG. INF.	
		31841	TAPON DE GASOLINA				23053	MANG. SUP.	
		31406	TAPONES DE RADIADOR	16 LBS.			36157	POLEA	
		38416	TENSOR				38001	POLEA LOCA	
V-8, 4.6 L	2010	33079	TERMOSTATOS	195°			K061015	SERPENTIN	
		38001	POLEA	LISA			31275	TAPON DE ACEITE	
		36157	POLEA	RANURADA			31841	TAPON DE GASOLINA	SIN LLAVE REGULAR
		38006	POLEA DEL TENSOR				38274	TENSOR MICRO-V	
		K061020	SERPENTIN		V-6, 4.0 L	2005	23050	MANG. SUP.	
		38274	TENSOR				38001	POLEA	
V-6, 4.0 L	2009	22038	MANGUERA DE PASO				K060875	SERPENTIN	
		23050	MANGUERA SUP.				31275	TAPON DE ACEITE	
		38001	POLEA				31841	TAPON DE GASOLINA	SIN LLAVE REGULAR
		K060875	SERPENTIN				33078	TERMOSTATO	180°F
		31841	TAPON DE GASOLINA		V-8, 4.6 L	2005	38001	POLEA	LOCA
		31842	TAPON DE GASOLINA	CON LLAVE			K061015	SERPENTIN	
		31406	TAPONES DE RADIADOR	16 LBS.			31275	TAPON DE ACEITE	
		38416	TENSOR				31841	TAPON DE GASOLINA	SIN LLAVE REGULAR



V-8, 4.6 L	2005	31406	TAPON DE RADIADOR	(16 lbs) Sin Palanca			31828	TAPON DE GASOLINA	CON LLAVE REGULAR
		38274	TENSOR MICRO-V				31830	TAPON DE GASOLINA	SIN LLAVE REGULAR
V-8, 4.6 L	2004	22249	MANGUERA INF.				31336	TAPON DE RADIADOR	(16 lbs) Sin Palanca
		22807	MANGUERA SUP.				38127	TENSOR MICRO-V	
		36100	POLEA	CON CANALES			33509	TERMOSTATO	195°F
		K060960	SERPENTIN	C/SÚPER CARGADOR			33009	TERMOSTATO	195°F
		K080751	SERPENTIN	SÚPER CARGADOR	V-8, 4.6 L	2000	19056	CALEF. A MOTOR	
		K060935	SERPENTIN	S/SÚPER CARGADOR			19728	CALEF. A TUBO-1	
		31109	TAPON DE ACEITE				91976	EDH	PRESION HYDROBOOSTER /
		31830	TAPON DE GASOLINA	SIN LLAVE REGULAR			22249	MANGUERA INF.	
		31406	TAPON DE RADIADOR	(16 lbs) Sin Palanca			20887	MANGUERA INF.	C/AA, C/DH
		38189	TENSOR MICRO-V				22307	MANGUERA SUP.	
		33469	TERMOSTATO	195°F			22449	MANGUERA SUP.	C/AA, C/DH
V-8, 4.6 L	2003	22249	MANGUERA INF.				36100	POLEA	CON CANALES
		38001	POLEA	ACCESORIO			38006	POLEA LOCA - INTERNA	
		36100	POLEA	CON CANALES			K060935	SERPENTIN	
		k060960	SERPENTIN				31109	TAPON DE ACEITE	
		K060935	SERPENTIN				31828	TAPON DE GASOLINA	CON LLAVE REGULAR
		K080751	SERPENTIN				31830	TAPON DE GASOLINA	SIN LLAVE REGULAR
		31109	TAPON DE ACEITE				31406	TAPON DE RADIADOR	(16 lbs) Sin Palanca
		31828	TAPON DE GASOLINA	CON LLAVE REGULAR			38189	TENSOR MICRO-V	
		31406	TAPON DE RADIADOR	(16 lbs) Sin Palanca			33029	TERMOSTATO	195°F
		38189	TENSOR MICRO-V	ACCESORIO	V-6, 3.8 L	1999	19106	CALEF. A TUBO-2	
		33189	TERMOSTATO	195°F			91986	EDH	PRESION
V-8, 4.6 L	2002	38006	POLEA	LISO			18813	MANGUERA DE PASO	
		36100	POLEA	CON CANALES			22042	MANGUERA INF.	
		k060960	SERPENTIN				22248	MANGUERA SUP.	
		K060935	SERPENTIN				19152	PASO	
		K080751	SERPENTIN	SUPERCARGADOR			38009	POLEA DEL TENSOR	
		31109	TAPON DE ACEITE				38006	POLEA LOCA	
		31828	TAPON DE GASOLINA	CON LLAVE REGULAR			K060994	SERPENTIN	
		31406	TAPON DE RADIADOR	(16 lbs) Sin Palanca			31109	TAPON DE ACEITE	
V-6, 3.8 L	2001	38189	TENSOR MICRO-V				31830	TAPON DE GASOLINA	SIN LLAVE REGULAR
		91986	EDH	PRESION			31828	TAPON DE GASOLINA	CON LLAVE REGULAR
		22042	MANGUERA INF.				31336	TAPON DE RADIADOR	(16 lbs) Sin Palanca
		22248	MANGUERA SUP.				38127	TENSOR MICRO-V	
		19152	PASO				33009	TERMOSTATO	195°F
		38009	POLEA DEL TENSOR				33009	TERMOSTATO	195°F
		38006	POLEA LOCA				19056	CALEF. A MOTOR	SOHC
		K060994	SERPENTIN				19728	CALEF. A TUBO-1	SOHC
		31109	TAPON DE ACEITE				91986	EDH	PRESION
		31830	TAPON DE GASOLINA	SIN LLAVE REGULAR	V-8, 4.6 L	1999	20887	INF. RADIADOR A TERMOSTATO	DOHC
		31336	TAPON DE RADIADOR	(16 lbs) Sin Palanca			21794	INF. TERMOSTATO A MOTOR	DOHC
		38127	TENSOR MICRO-V				22249	MANGUERA INF.	SOHC
		33509	TERMOSTATO	195°F			22307	MANGUERA SUP.	SOHC
		33009	TERMOSTATO	195°F			22449	MANGUERA SUP.	DOHC
V-8, 4.6 L	2001	19056	CALEF. A MOTOR	SOHC			22561	PASO	DOHC
		19728	CALEF. A TUBO-1	SOHC			38006	POLEA LOCA	DOHC
		91986	EDH	PRESION			K060975	SERPENTIN	CONVERTIBLE
		20887	INF. RADIADOR A TERMOSTATO	DOHC			31109	TAPON DE ACEITE	
		21794	INF. TERMOSTATO A MOTOR	DOHC			31830	TAPON DE GASOLINA	SIN LLAVE REGULAR
		22249	MANGUERA INF.	SOHC			31828	TAPON DE GASOLINA	CON LLAVE REGULAR
		22307	MANGUERA SUP.	SOHC			31406	TAPON DE RADIADOR	(16 lbs) Sin Palanca
		22449	MANGUERA SUP.	DOHC			38132	TENSOR MICRO-V	
		22561	PASO	DOHC			33029	TERMOSTATO	195°F
		38006	POLEA	LISO			91982	EDH	PRESION
		36100	POLEA	CON CANALES	V-6, 3.8 L	1998	18813	MANGUERA DE PASO	
		K060935	SERPENTIN	SOHC			22042	MANGUERA INF.	
		K060994	SERPENTIN	C/AA, C/DH			22248	MANGUERA SUP.	
		31109	TAPON DE ACEITE				38009	POLEA	
		31830	TAPON DE GASOLINA	SIN LLAVE REGULAR			38029	POLEA	
		31828	TAPON DE GASOLINA	CON LLAVE REGULAR			38006	POLEA	
		31406	TAPON DE RADIADOR	(16 lbs) Sin Palanca			38022	POLEA	
		38189	TENSOR MICRO-V				K060984	SERPENTIN	
		33029	TERMOSTATO	195°F			31109	TAPON DE ACEITE	
V-6, 3.8 L	2000	19106	CALEF. A TUBO-2				31336	TAPON DE RADIADOR	(16 lbs) Sin Palanca
		91986	EDH	PRESION			38127	TENSOR MICRO-V	
		22042	MANGUERA INF.				33509	TERMOSTATO	195°F
		22248	MANGUERA SUP.				91976	EDH	PRESION
		19152	PASO				20887	MANGUERA INF.	C/AA, C/DH
		38029	POLEA		V-8, 4.6 L	1998	22449	MANGUERA SUP.	C/AA, C/DH
		38009	POLEA DEL TENSOR				38006	POLEA LOCA	
		38006	POLEA LOCA				K060975	SERPENTIN	CONVERTIBLE
		K060994	SERPENTIN						
		31109	TAPON DE ACEITE						

V-8, 4.6 L	1998	38132	TENSOR MICRO-V	
V-6, 3.8 L	1997	18813	MANGUERA DE PASO	
		22042	MANGUERA INF.	
		22248	MANGUERA SUP.	
		38029	POLEA	
		38009	POLEA	
		38022	POLEA	
		K060984	SERPENTIN	
		38127	TENSOR MICRO-V	
		33009	TERMOSTATO	195°F
V-8, 4.6 L	1997	91976	EDH	PRESION
		20887	MANGUERA INF.	4 CIL, 2.3 L
		22449	MANGUERA SUP.	C/AA, C/DH
		38006	POLEA LOCA	C/AA, C/DH
		K060975	SERPENTIN	CONVERTIBLE
		38132	TENSOR MICRO-V	

		22654	MANG. INF.	
		22653	MANG. SUP.	
		38006	POLEA DEL TENSOR	
		38001	POLEA LOCA	C/AA
		K060827	SERPENTIN	C/AA
		K060730	SERPENTIN	S/AA
		31842	TAPON DE GASOLINA	CON LLAVE REGULAR
		31841	TAPON DE GASOLINA	SIN LLAVE REGULAR
		31406	TAPON DE RADIADOR	(16 lbs) Sin Palanca
		38155	TENSOR MICRO-V	
		80346	EDH	PRESION
		22654	MANGUERA INF.	
		22653	MANGUERA SUP.	
		38006	POLEA DEL TENSOR	
		38001	POLEA LOCA	C/AA
		K060827	SERPENTIN	C/AA
		K060730	SERPENTIN	S/AA
		31109	TAPON DE ACEITE	
		31828	TAPON DE GASOLINA	CON LLAVE REGULAR
		31830	TAPON DE GASOLINA	SIN LLAVE REGULAR
		31406	TAPON DE RADIADOR	(16 lbs) Sin Palanca
		38155	TENSOR MICRO-V	
		T276	BANDA ARBOL DE LEVAS	{131 D x 22.3 mm}
		19140	CALEF. A TUBO-1	
		80346	EDH	PRESION
		TCK276	KIT DE DISTRIBUCION	
		22654	MANGUERA INF.	
		22653	MANGUERA SUP.	
		38006	POLEA DEL TENSOR	
		38001	POLEA LOCA	C/AA
		K060827	SERPENTIN	C/AA
		K060730	SERPENTIN	S/AA
		31109	TAPON DE ACEITE	
		31830	TAPON DE GASOLINA	SIN LLAVE REGULAR
		31828	TAPON DE GASOLINA	CON LLAVE REGULAR
		31406	TAPON DE RADIADOR	(16 lbs) Sin Palanca
		38155	TENSOR MICRO-V	
		22351	MANGUERA INF.	
		22144	MANGUERA SUP.	
		38006	POLEA DEL TENSOR	
		38001	POLEA LOCA	
		35B 3/8"	RECUPERADOR	
		K060858	SERPENTIN	S/AA
		K060882	SERPENTIN	C/AA
		31275	TAPON DE ACEITE	
		31828	TAPON DE GASOLINA	CON LLAVE REGULAR
		31830	TAPON DE GASOLINA	SIN LLAVE REGULAR
		31336	TAPON DE RADIADOR	(16 lbs) Sin Palanca
		38114	TENSOR MICRO-V	
		33509	TERMOSTATO	195°F
		T276	BANDA ARBOL DE LEVAS	{131 D x 22.3 mm}
		19140	CALEF. A TUBO-1	
		TCK276	KIT DE DISTRIBUCION	
		22654	MANGUERA INF.	
		22653	MANGUERA SUP.	
		19227	PASO	
		38006	POLEA DEL TENSOR	
		K060827	SERPENTIN	C/AA
		K060730	SERPENTIN	S/AA
		31275	TAPON DE ACEITE	
		31830	TAPON DE GASOLINA	SIN LLAVE REGULAR
		31828	TAPON DE GASOLINA	CON LLAVE REGULAR
		31336	TAPON DE RADIADOR	(16 lbs) Sin Palanca
		T41005	TENSOR ARBOL DE LEVAS	
		38155	TENSOR MICRO-V	
		T276	BANDA ARBOL DE LEVAS	{131 D x 22.3 mm}
		18916	CALEF. A BA	S/AA
		TCK276	KIT DE DISTRIBUCION	
		22364	MANGUERA INF.	
		22380	MANGUERA SUP.	
		38006	POLEA DEL TENSOR	
		38001	POLEA LOCA	
		K060820	SERPENTIN	C/AA
		K060696	SERPENTIN	S/AA
		31109	TAPON DE ACEITE	











**MUSTANG SHELBY**

V-8, 5.4 L	2010	K060868	SERPENTIN	ACCESORIOS	
		38385	TENSOR	SUPER CARGADO	
V-8, 5.4 L	2009	K060868	SERPENTIN	ACCESORIOS	
		38385	TENSOR	SUPER CARGADO	4 CIL, 2.3 L

**RANGER**

4 CIL, 2.3 L	2010	K060828	SERPENTIN	CON A.A.	
		K060730	SERPENTIN	SIN A.A.	
		31275	TAPON DE ACEITE		
		31841	TAPON DE GASOLINA		
		31842	TAPON DE GASOLINA	CON LLAVE	
		31406	TAPONES DE RADIADOR	16 LBS.	
		38155	TENSOR		
		34044	TERMOSTATOS	180°	
4 CIL, 2.3 L	2009	22654	MANGUERA INF.		
		21947	MANGUERA SUP.		
		K060730	SERPENTIN	SIN A.A.	
		K060828	SERPENTIN	CON A.A.	
		31275	TAPON DE ACEITE		V-6, 3.0 L
		31841	TAPON DE GASOLINA		
		31842	TAPON DE GASOLINA	CON LLAVE	
		31406	TAPONES DE RADIADOR	16 LBS.	
		38155	TENSOR		
		34044	TERMOSTATOS	180°	
4 CIL, 2.3 L	2008	22654	MANGUERA INF.		
		21947	MANGUERA SUP.		
		K060828	SERPENTIN	CON A.A.	
		K060730	SERPENTIN	SIN A.A.	
		31275	TAPON DE ACEITE		
		31841	TAPON DE GASOLINA		
		31842	TAPON DE GASOLINA	CON LLAVE	
		31406	TAPONES DE RADIADOR	16 LBS.	4 CIL, 2.3 L
		38155	TENSOR		
		34044	TERMOSTATOS	180°	
4 CIL, 2.3 L	2007	22654	MANG. INF.		
		21947	MANG. SUP.		
		K060827	SERPENTIN	C/AA	
		K060730	SERPENTIN	S/AA	
		31841	TAPON DE GASOLINA	SIN LLAVE REGULAR	
		31406	TAPON DE RADIADOR	(16 lbs) Sin Palanca	
		38155	TENSOR MICRO-V		
4 CIL, 2.3 L	2006	22654	MANG. INF.		
		21947	MANG. SUP.		
		K060827	SERPENTIN	C/AA	
		K060730	SERPENTIN	S/AA	
		31841	TAPON DE GASOLINA	SIN LLAVE REGULAR	
		31406	TAPON DE RADIADOR	(16 lbs) Sin Palanca	4 CIL, 2.5 L
		38155	TENSOR MICRO-V		
4 CIL, 2.3 L	2005	80346	EDH	PRESION	
		22654	MANG. INF.		
		K060827	SERPENTIN	C/AA	
		K060730	SERPENTIN	S/AA	
		31841	TAPON DE GASOLINA	SIN LLAVE REGULAR	
		31406	TAPON DE RADIADOR	(16 lbs) Sin Palanca	
		38155	TENSOR MICRO-V		
4 CIL, 2.3 L	2004	80346	EDH	PRESION	

2003	80346	EDH	PRESION
	22654	MANGUERA INF.	
	22653	MANGUERA SUP.	
	38006	POLEA DEL TENSOR	
	38001	POLEA LOCA	C/AA
	K060827	SERPENTIN	C/AA
	K060730	SERPENTIN	S/AA
	31842	TAPON DE GASOLINA	CON LLAVE REGULAR
	31841	TAPON DE GASOLINA	SIN LLAVE REGULAR
	31406	TAPON DE RADIADOR	(16 lbs) Sin Palanca
	38155	TENSOR MICRO-V	
	80346	EDH	PRESION
	22654	MANGUERA INF.	
	22653	MANGUERA SUP.	
	38006	POLEA DEL TENSOR	
	38001	POLEA LOCA	C/AA
	K060827	SERPENTIN	C/AA
	K060730	SERPENTIN	S/AA
	31109	TAPON DE ACEITE	
	31828	TAPON DE GASOLINA	CON LLAVE REGULAR
	31830	TAPON DE GASOLINA	SIN LLAVE REGULAR
	31406	TAPON DE RADIADOR	(16 lbs) Sin Palanca
	38155	TENSOR MICRO-V	
	T276	BANDA ARBOL DE LEVAS	{131 D x 22.3 mm}
	19140	CALEF. A TUBO-1	
	80346	EDH	PRESION
	TCK276	KIT DE DISTRIBUCION	
	22654	MANGUERA INF.	
	22653	MANGUERA SUP.	
	38006	POLEA DEL TENSOR	
	38001	POLEA LOCA	C/AA
	K060827	SERPENTIN	C/AA
	K060730	SERPENTIN	S/AA
	31109	TAPON DE ACEITE	
	31830	TAPON DE GASOLINA	SIN LLAVE REGULAR
	31828	TAPON DE GASOLINA	CON LLAVE REGULAR
	31406	TAPON DE RADIADOR	(16 lbs) Sin Palanca
	38155	TENSOR MICRO-V	
	22351	MANGUERA INF.	
	22144	MANGUERA SUP.	
	38006	POLEA DEL TENSOR	
	38001	POLEA LOCA	
	35B 3/8"	RECUPERADOR	
	K060858	SERPENTIN	S/AA
	K060882	SERPENTIN	C/AA
	31275	TAPON DE ACEITE	
	31828	TAPON DE GASOLINA	CON LLAVE REGULAR
	31830	TAPON DE GASOLINA	SIN LLAVE REGULAR
	31336	TAPON DE RADIADOR	(16 lbs) Sin Palanca
	38114	TENSOR MICRO-V	
	33509	TERMOSTATO	195°F
	T276	BANDA ARBOL DE LEVAS	{131 D x 22.3 mm}
	19140	CALEF. A TUBO-1	
	TCK276	KIT DE DISTRIBUCION	
	22654	MANGUERA INF.	
	22653	MANGUERA SUP.	
	19227	PASO	
	38006	POLEA DEL TENSOR	
	K060827	SERPENTIN	C/AA
	K060730	SERPENTIN	S/AA
	31275	TAPON DE ACEITE	
	31830	TAPON DE GASOLINA	SIN LLAVE REGULAR
	31828	TAPON DE GASOLINA	CON LLAVE REGULAR
	31336	TAPON DE RADIADOR	(16 lbs) Sin Palanca
	T41005	TENSOR ARBOL DE LEVAS	
	38155	TENSOR MICRO-V	
	T276	BANDA ARBOL DE LEVAS	{131 D x 22.3 mm}
	18916	CALEF. A BA	S/AA
	TCK276	KIT DE DISTRIBUCION	
	22364	MANGUERA INF.	
	22380	MANGUERA SUP.	
	38006	POLEA DEL TENSOR	
	38001	POLEA LOCA	
	K060820	SERPENTIN	C/AA
	K060696	SERPENTIN	S/AA
	31109	TAPON DE ACEITE	

    				    				
4 CIL, 2.5 L	2001	31828 TAPON DE GASOLINA 31830 TAPON DE GASOLINA 31336 TAPON DE RADIADOR T41005 TENSOR ARBOL DE LEVAS 38155 TENSOR MICRO-V 33299 TERMOSTATO	CON LLAVE REGULAR SIN LLAVE REGULAR (16 lbs) Sin Palanca	4 CIL, 2.5 L	1999	33779 TERMOSTATO T276 BANDA ARBOL DE LEVAS 352890(803: EDH TCK276 KIT DE DISTRIBUCION 22364 MANGUERA INF. 22380 MANGUERA SUP. 22380 MANGUERA SUP. 38006 POLEA DEL TENSOR 38001 POLEA LOCA K060696 SERPENTIN K060820 SERPENTIN K060820 SERPENTIN 31109 TAPON DE ACEITE 31830 TAPON DE GASOLINA 31828 TAPON DE GASOLINA 31336 TAPON DE RADIADOR T41005 TENSOR ARBOL DE LEVAS 38155 TENSOR MICRO-V 33299 TERMOSTATO	195°F S/AA 195°F C/AA S/AA CON LLAVE REGULAR SIN LLAVE REGULAR (16 lbs) Sin Palanca CON LLAVE REGULAR SIN LLAVE REGULAR (16 lbs) Sin Palanca 195°F PRESION	195°F {131 D x 22.3 mm} PRESION S/AA C/AA SIN LLAVE REGULAR CON LLAVE REGULAR (16 lbs) Sin Palanca 195°F PRESION
V-6, 3.0 L	2001	22469 CALEF. A BA 22468 CALEF. A MOTOR 22351 MANGUERA INF. 22144 MANGUERA SUP. 38006 POLEA DEL TENSOR 38001 POLEA LOCA K060882 SERPENTIN K060858 SERPENTIN 31275 TAPON DE ACEITE 31828 TAPON DE GASOLINA 31830 TAPON DE GASOLINA 31336 TAPON DE RADIADOR 38114 TENSOR MICRO-V 33509 TERMOSTATO	195°F S/AA C/AA S/AA CON LLAVE REGULAR SIN LLAVE REGULAR (16 lbs) Sin Palanca 195°F	V-6, 3.0 L	1999	352890(803: EDH 22351 MANGUERA INF. 22144 MANGUERA SUP. 38006 POLEA DEL TENSOR 38001 POLEA LOCA K060882 SERPENTIN K060858 SERPENTIN 31109 TAPON DE ACEITE 31828 TAPON DE GASOLINA 31830 TAPON DE GASOLINA 31336 TAPON DE RADIADOR 38114 TENSOR MICRO-V 33509 TERMOSTATO	195°F PRESION	195°F PRESION
V-6, 4.0 L	2001	22350 MANGUERA INF. 22646 MANGUERA SUP. 38008 POLEA DEL TENSOR 38001 POLEA LOCA K060810 SERPENTIN K060882 SERPENTIN 31275 TAPON DE ACEITE 31830 TAPON DE GASOLINA 31828 TAPON DE GASOLINA 31336 TAPON DE RADIADOR 38137 TENSOR MICRO-V 33079 TERMOSTATO	195°F S/AA C/AA S/AA C/AA SIN LLAVE REGULAR CON LLAVE REGULAR (16 lbs) Sin Palanca 195°F	V-6, 4.0 L	1999	352890(803: EDH 22350 MANGUERA INF. 22349 MANGUERA SUP. 38008 POLEA DEL TENSOR 38001 POLEA LOCA K060810 SERPENTIN K060882 SERPENTIN 31109 TAPON DE ACEITE 31830 TAPON DE GASOLINA 31828 TAPON DE GASOLINA 31336 TAPON DE RADIADOR 38102 TENSOR MICRO-V 33779 TERMOSTATO	195°F PRESION	195°F PRESION
4 CIL, 2.5 L	2000	T276 BANDA ARBOL DE LEVAS 18916 CALEF. A BA 352890(803: EDH TCK276 KIT DE DISTRIBUCION 22364 MANGUERA INF. 22380 MANGUERA SUP. 38006 POLEA DEL TENSOR 38001 POLEA LOCA K060696 SERPENTIN K060820 SERPENTIN 31109 TAPON DE ACEITE 31830 TAPON DE GASOLINA 31828 TAPON DE GASOLINA 31336 TAPON DE RADIADOR T41005 TENSOR ARBOL DE LEVAS 38155 TENSOR MICRO-V 33299 TERMOSTATO	195°F {131 D x 22.3 mm} S/AA PRESION S/AA C/AA SIN LLAVE REGULAR CON LLAVE REGULAR (16 lbs) Sin Palanca 195°F	4 CIL, 2.5 L	1998	352890(803: EDH TCK276 KIT DE DISTRIBUCION 38001 POLEA 38006 POLEA T41005 TENSOR ARBOL DE LEVAS 38155 TENSOR MICRO-V	195°F PRESION	195°F PRESION
V-6, 3.0 L	2000	22468 CALEF. A MOTOR 352890(803: EDH 22351 MANGUERA INF. 22144 MANGUERA SUP. 38006 POLEA DEL TENSOR 38001 POLEA LOCA K060858 SERPENTIN K060882 SERPENTIN 31109 TAPON DE ACEITE 31830 TAPON DE GASOLINA 31828 TAPON DE GASOLINA 31336 TAPON DE RADIADOR 38114 TENSOR MICRO-V 33509 TERMOSTATO	195°F PRESION S/AA C/AA SIN LLAVE REGULAR CON LLAVE REGULAR (16 lbs) Sin Palanca 195°F	V-6, 3.0 L	1998	352890(803: EDH 22351 MANG. INF. 22144 MANG. SUP. 38006 POLEA LOCA K060415 SERPENTIN K060696 SERPENTIN K060858 SERPENTIN K060820 SERPENTIN K060882 SERPENTIN 38114 TENSOR MICRO-V	195°F PRESION	195°F PRESION
V-6, 4.0 L	2000	352890(803: EDH 22350 MANGUERA INF. 22349 MANGUERA SUP. 38008 POLEA DEL TENSOR 38001 POLEA LOCA K060810 SERPENTIN K060882 SERPENTIN 31109 TAPON DE ACEITE 31830 TAPON DE GASOLINA 31828 TAPON DE GASOLINA 31336 TAPON DE RADIADOR 38114 TENSOR MICRO-V 33509 TERMOSTATO	195°F PRESION S/AA C/AA SIN LLAVE REGULAR CON LLAVE REGULAR (16 lbs) Sin Palanca 195°F	4 CIL, 2.3 L	1997	T276 BANDA ARBOL DE LEVAS 360530(718: EDH TCK276 KIT DE DISTRIBUCION 22156 MANG. INF. 22155 MANG. SUP. 38006 POLEA DEL TENSOR 38009 POLEA LOCA K060696 SERPENTIN K060415 SERPENTIN K060820 SERPENTIN 31109 TAPON DE ACEITE 31615 TAPON DE GASOLINA 31336 TAPON DE RADIADOR T41005 TENSOR ARBOL DE LEVAS 38155 TENSOR MICRO-V 33299 TERMOSTATO	195°F PRESION	195°F PRESION



**RANGER F-100**





					V-10, 6.8 L	2002	31406	TAPON DE RADIADOR	(16 lbs) Sin Palanca
							22432	MANGUERA INF.	
							22431	MANGUERA SUP.	
4 CIL, 2.5 L	2001	22364	MANGUERA INF.				38023	POLEA DEL TENSOR	LISA
		22380	MANGUERA SUP.				38022	POLEA LOCA	
V-6, 3.0 L	2001	22351	MANGUERA INF.				K060997	SERPENTIN	C/AA
		22144	MANGUERA SUP.				K060806	SERPENTIN	S/AA
V-6, 4.0 L	2001	22350	MANGUERA INF.	C/AA			38133	TENSOR MICRO-V	C/AA
		22349	MANGUERA SUP.	C/AA			38329	TENSOR MICRO-V	
4 CIL, 2.3 L	2000	K060696	SERPENTIN	S/AA, C/DH			38274	TENSOR MICRO-V	
		K060820	SERPENTIN	C/AA, C/DH	V-8, 5.4 L	2002	22430	MANGUERA INF.	
4 CIL, 2.5 L	2000	T276	BANDA ARBOL DE LEVAS	{131 D x 22.3 mm}			22429	MANGUERA SUP.	
		22364	MANGUERA INF.				38001	POLEA	LISO
		22380	MANGUERA SUP.				38023	POLEA DEL TENSOR	LISA
V-6, 3.0 L	2000	22351	MANGUERA INF.				38022	POLEA LOCA	
		22144	MANGUERA SUP.				K060997	SERPENTIN	C/AA
		K060858	SERPENTIN	S/AA			K060806	SERPENTIN	S/AA
		K060882	SERPENTIN	C/AA			38133	TENSOR MICRO-V	C/AA
V-6, 4.0 L	2000	22350	MANGUERA INF.	C/AA			38274	TENSOR MICRO-V	
		22349	MANGUERA SUP.	C/AA			38329	TENSOR MICRO-V	
4 CIL, 2.3 L	1999	K060696	SERPENTIN	S/AA, C/DH	V-8, 7.3 L	2002	19201	CALEF. A B.A.	
		K060820	SERPENTIN	C/AA, C/DH			19200	CALEF. A MOTOR	
4 CIL, 2.5 L	1999	T276	BANDA ARBOL DE LEVAS	{131 D x 22.3 mm}			22433	MANGUERA SUP.	Manguera preferida; ruta alrede
		22364	MANGUERA INF.				22542	MANGUERA SUP.	Manguera opcional; Ruta a trav
		22380	MANGUERA SUP.				38028	POLEA	LISO
V-6, 3.0 L	1999	22351	MANGUERA INF.				38053	POLEA	CON CANALES
		22144	MANGUERA SUP.				38023	POLEA DEL TENSOR	LISA
		K060882	SERPENTIN	C/AA			35B 3/8"	RECUPERADOR	C/ manguera de dia. 3/8"
		K060858	SERPENTIN	S/AA			K081213	SERPENTIN	C/Alt 121.3" Belt O.C.
V-6, 4.0 L	1999	22350	MANGUERA INF.	C/AA			K081223	SERPENTIN	S/alt.para ambulancia; C/1 Alt.;
		22349	MANGUERA SUP.	C/AA			K081377	SERPENTIN	C/Alt.para ambulancia.; C/Alt. C
4 CIL, 2.3 L	1998	K060696	SERPENTIN	S/AA, C/DH			38191	TENSOR MICRO-V	
		K060820	SERPENTIN	C/AA, C/DH	V-8, 5.4 L	2001	19218	CALEF. A MULTIPLE	Re-usar el restrictor de flujo
		K060415	SERPENTIN	S/AA, S/DH			22430	MANGUERA INF.	
4 CIL, 2.5 L	1998	T276	BANDA ARBOL DE LEVAS	{131 D x 22.3 mm}			22429	MANGUERA SUP.	
		22364	MANGUERA INF.				38053	POLEA	
		22380	MANGUERA SUP.				38023	POLEA DEL TENSOR - LISA	
V-6, 3.0 L	1998	22351	MANGUERA INF.				38022	POLEA LOCA	
		22144	MANGUERA SUP.				K081000	SERPENTIN	C/AA
		K060858	SERPENTIN	S/AA			K080806	SERPENTIN	S/AA
		K060882	SERPENTIN	C/AA			38133	TENSOR MICRO-V	C/AA
V-6, 4.0 L	1998	22350	MANGUERA INF.	C/AA			38330	TENSOR MICRO-V	
		22349	MANGUERA SUP.	C/AA	V-8, 7.3 L	2001	19201	CALEF. A BA	
4 CIL, 2.3 L	1997	T276	BANDA ARBOL DE LEVAS	{131 D x 22.3 mm}			19200	CALEF. A MOTOR	
		22156	MANGUERA INF.				22542	MANGUERA SUP.	Manguera Opcional, ruta a trav
		22155	MANGUERA SUP.				22433	MANGUERA SUP.	Manguera Preferente, ruta a tra
		K060696	SERPENTIN	S/AA, C/DH			38028	POLEA	LISO
		K060415	SERPENTIN	S/AA, S/DH			38053	POLEA	CON CANALES
		K060820	SERPENTIN	C/AA, C/DH			38023	POLEA DEL TENSOR - LISA	
V-6, 3.0 L	1997	22255	MANGUERA INF.				K081223	SERPENTIN	S/alternador p/ambulancia,1alt
		22284	MANGUERA SUP.				K081377	SERPENTIN	C/Alternador p/ambulancia; C/A
		K060882	SERPENTIN	C/AA			38191	TENSOR MICRO-V	
		K060858	SERPENTIN	S/AA	V-10, 6.8 L	2000	19218	CALEF. A MULTIPLE	Re-usar el restrictor de flujo
V-6, 4.0 L	1997	21623	MANGUERA INF.	C/AA			352850(803	EDH	PRESION C/SIS. CONV.
		20983	MANGUERA SUP.	C/AA			22432	MANGUERA INF.	



**SUPER DUTY PICKUP**

V-10, 6.8 L	2003	K060990	SERPENTIN	C/AA			22431	MANGUERA SUP.	
		31109	TAPON DE ACEITE				38022	POLEA	
		31615	TAPON DE GASOLINA	SIN LLAVE C/CONT. DE EMIS			38023	POLEA	LISO
		31406	TAPON DE RADIADOR	(16 lbs) Sin Palanca			38022	POLEA LOCA	
		38274	TENSOR MICRO-V				K081102	SERPENTIN	C/Stripped Chassis
		38329	TENSOR MICRO-V				K080806	SERPENTIN	S/AA; S/Stripped Chassis
		33469	TERMOSTATO	195°F			K081000	SERPENTIN	C/AA
V-8, 5.4 L	2003	38001	POLEA	LISO			31109	TAPON DE ACEITE	
		K060997	SERPENTIN	C/AA			31734	TAPON DE GASOLINA	CON LLAVE C/CONT. DE EMIS
		K060806	SERPENTIN	S/AA			31615	TAPON DE GASOLINA	SIN LLAVE C/CONT. DE EMIS
		31109	TAPON DE ACEITE				31828	TAPON DE GASOLINA	CON LLAVE REGULAR
		31615	TAPON DE GASOLINA	SIN LLAVE C/CONT. DE EMIS			31830	TAPON DE GASOLINA	SIN LLAVE REGULAR
		31406	TAPON DE RADIADOR	(16 lbs) Sin Palanca			31406	TAPON DE RADIADOR	(16 lbs) Sin Palanca
		38274	TENSOR MICRO-V				38133	TENSOR MICRO-V	C/AA
		38329	TENSOR MICRO-V				38330	TENSOR MICRO-V	
V-8, 6.0 L DIESEL	2003	K081265	SERPENTIN		V-8, 5.4 L	2000	33469	TERMOSTATO	195°F
		31109	TAPON DE ACEITE				19218	CALEF. A MULTIPLE	Re-usar el restrictor de flujo
		31615	TAPON DE GASOLINA	SIN LLAVE C/CONT. DE EMIS			352850(803	EDH	PRESION C/SIS. CONV.
							22430	MANGUERA INF.	
							22429	MANGUERA SUP.	

V-8, 5.4 L	2000	38053	POLEA						K060990	SERPENTIN	C/A.A.		
		38023	POLEA DEL TENSOR - LISA						K080660	SERPENTIN	Supercargador		
		38022	POLEA LOCA						K060806	SERPENTIN	Sin A.A.		
		K081000	SERPENTIN	C/AA					31109	TAPON DE ACEITE			
		K080806	SERPENTIN	S/AA					31830	TAPON DE GASOLINA	SIN LLAVE REGULAR		
		31109	TAPON DE ACEITE						31406	TAPON DE RADIADOR	(16 lbs) Sin Palanca		
		31615	TAPON DE GASOLINA	SIN LLAVE C/CONT. DE EMIS					38329	SENSOR MICRO-V			
		31734	TAPON DE GASOLINA	CON LLAVE C/CONT. DE EMI:					38274	SENSOR MICRO-V			
		31828	TAPON DE GASOLINA	CON LLAVE REGULAR					33469	TERMOSTATO	195°F		
		31830	TAPON DE GASOLINA	SIN LLAVE REGULAR	V-10, 6.8 L			2002	19191	CALEF. A TUBO-1	S/Calef. Auxiliar		
		31406	TAPON DE RADIADOR	(16 lbs) Sin Palanca					K060990	SERPENTIN	C/AA		
		38133	SENSOR MICRO-V	C/AA					K060806	SERPENTIN	S/AA		
V-8, 7.3 L	2000	19201	CALEF. A BA						31109	TAPON DE ACEITE			
		19200	CALEF. A MOTOR						31830	TAPON DE GASOLINA	SIN LLAVE REGULAR		
		80321	EDH	PRESION, C/SIST. CONV					31406	TAPON DE RADIADOR	(16 lbs) Sin Palanca		
		22434	MANGUERA INF.						38329	SENSOR MICRO-V			
		22542	MANGUERA SUP.	Manguera Opcional, ruta a trav	V-8, 5.4 L			2002	19191	CALEF. A TUBO-1	S/Calef. Auxiliar		
		22433	MANGUERA SUP.	Manguera Preferente, ruta a tra					K060990	SERPENTIN	C/AA		
		38028	POLEA	LISO					K060806	SERPENTIN	S/AA		
		38053	POLEA	CON CANALES					38274	SENSOR MICRO-V			
		38023	POLEA DEL TENSOR - LISA						38329	SENSOR MICRO-V			
		K081377	SERPENTIN	C/Alternador p/ambulancia; C/AV-10, 6.8 L				2001	19191	CALEF. A TUBO-1	S/Calef. Auxiliar		
		K081223	SERPENTIN	S/alternador p/ambulancia, 1altt					91966	EDH	PRESION, C/SIST. CONV		
		31109	TAPON DE ACEITE						22371	MANGUERA INF.			
V-10, 6.8 L	1999	31615	TAPON DE GASOLINA	SIN LLAVE C/CONT. DE EMIS					22316	MANGUERA SUP.			
		31406	TAPON DE RADIADOR	(16 lbs) Sin Palanca					38022	POLEA			
		38191	SENSOR MICRO-V						38053	POLEA			
		33909	TERMOSTATO	195°F					38023	POLEA DEL TENSOR - LISA			
		19218	CALEF. A MULTIPLE	Re-usar el restrictor de flujo					K080991	SERPENTIN	C/AA		
		22432	MANGUERA INF.						K080806	SERPENTIN	S/AA		
		22431	MANGUERA SUP.						31109	TAPON DE ACEITE			
		38022	POLEA						31831	TAPON DE GASOLINA	SIN LLAVE REGULAR		
		38023	POLEA DEL TENSOR - LISA						31406	TAPON DE RADIADOR	(16 lbs) Sin Palanca		
		38022	POLEA LOCA						38133	SENSOR MICRO-V	C/AA		
		K081102	SERPENTIN	C/Stripped Chassis					38330	SENSOR MICRO-V			
		K081000	SERPENTIN	C/AA					33469	TERMOSTATO	195°F		
V-8, 5.4 L	1999	K080806	SERPENTIN	S/AA; S/Stripped Chassis	V-6, 4.2 L		2001	19286	CALEF. A MULTIPLE	S/Calef. Auxiliar; Re-usar el res			
		38133	SENSOR MICRO-V	C/AA				22314	MANGUERA SUP.				
		38330	SENSOR MICRO-V						19025	PASO			
		19218	CALEF. A MULTIPLE	Re-usar el restrictor de flujo					38007	POLEA DEL TENSOR			
		22430	MANGUERA INF.						38001	POLEA LOCA LISA	C/AA		
		22429	MANGUERA SUP.						K061025	SERPENTIN	C/AA		
		38053	POLEA						K060970	SERPENTIN	S/AA		
		38023	POLEA DEL TENSOR - LISA						31109	TAPON DE ACEITE			
		38022	POLEA LOCA						31615	TAPON DE GASOLINA	SIN LLAVE C/CONT. DE EMIS		
		K080806	SERPENTIN	S/AA					31406	TAPON DE RADIADOR	(16 lbs) Sin Palanca		
		K081000	SERPENTIN	C/AA					38138	SENSOR MICRO-V			
		38133	SENSOR MICRO-V	C/AA					33469	TERMOSTATO	195°F		
V-8, 7.3 L	1999	38330	SENSOR MICRO-V		V-8, 5.4 L		2001	19191	CALEF. A TUBO-1	S/Calef. Auxiliar			
		19201	CALEF. A BA					91966	EDH	PRESION			
		19200	CALEF. A MOTOR						22318	MANGUERA INF.			
		22434	MANGUERA INF.						22315	MANGUERA SUP.			
		22433	MANGUERA SUP.	Manguera Preferente, ruta a tra					38023	POLEA			
		22542	MANGUERA SUP.	Manguera Opcional, ruta a trav					38053	POLEA			
		38053	POLEA	CON CANALES					38022	POLEA			
		38028	POLEA	LISO					K080806	SERPENTIN	S/AA		
		38023	POLEA DEL TENSOR - LISA						K080911	SERPENTIN	C/AA		
		K081223	SERPENTIN	S/alternador p/ambulancia, 1altt					31109	TAPON DE ACEITE			
		K081377	SERPENTIN	C/Alternador p/ambulancia; C/A					31406	TAPON DE RADIADOR	(16 lbs) Sin Palanca		
		38191	SENSOR MICRO-V						38133	SENSOR MICRO-V			
<b>SUPER DUTY VAN</b>													
V-6, 4.2 L	2003	31109	TAPON DE ACEITE						19202	CALEF. A BA	195°F		
		31830	TAPON DE GASOLINA	SIN LLAVE REGULAR					91967	EDH	PRESION		
		31406	TAPON DE RADIADOR	(16 lbs) Sin Palanca					22319	MANGUERA INF.			
V-8, 4.6 L	2003	33469	TERMOSTATO	195°F					22312	MANGUERA SUP.			
		22298	MANGUERA INF.	C/Tracción 4 ruedas					38053	POLEA	CON CANALES		
		22297	MANGUERA INF.	C/Tracción 2 ruedas					38028	POLEA	LISO		
		22315	MANGUERA SUP.						38023	POLEA DEL TENSOR - LISA			
		38001	POLEA						K081213	SERPENTIN	C/Alt. Heavy Duty		
		38022	POLEA LOCA	Lisa, C/Supercargador					K081359	SERPENTIN	C/Doble Alt.		
K080991	SERPENTIN	C/Supercargador					31109	TAPON DE ACEITE					
							31406	TAPON DE RADIADOR	(16 lbs) Sin Palanca				



    				
V-8, 7.3 L	2001	33909	TERMOSTATO	195°F
V-10, 6.8 L	2000	19191	CALEF. A TUBO-1	S/Calef. Auxiliar
		91966	EDH	PRESION SIS. CONV.
		22371	MANGUERA INF.	
		22316	MANGUERA SUP.	
		38022	POLEA	
		38053	POLEA	
		38023	POLEA DEL TENSOR - LISA	
		K080991	SERPENTIN	C/AA
		K080806	SERPENTIN	S/AA
		31109	TAPON DE ACEITE	
		31830	TAPON DE GASOLINA	SIN LLAVE REGULAR
		31406	TAPON DE RADIADOR	(16 lbs) Sin Palanca
		38133	SENSOR MICRO-V	C/AA
		38330	SENSOR MICRO-V	
		33469	TERMOSTATO	195°F
V-8, 5.4 L	2000	19191	CALEF. A TUBO-1	S/Calef. Auxiliar
		91966	EDH	PRESION
		22318	MANGUERA INF.	
		22315	MANGUERA SUP.	
		38053	POLEA	
		38022	POLEA	
		38023	POLEA DEL TENSOR - LISA	
		K080806	SERPENTIN	S/AA
		K080991	SERPENTIN	C/AA
		31109	TAPON DE ACEITE	
		31830	TAPON DE GASOLINA	SIN LLAVE REGULAR
		31406	TAPON DE RADIADOR	(16 lbs) Sin Palanca
		38133	SENSOR MICRO-V	C/AA
		38330	SENSOR MICRO-V	
		33469	TERMOSTATO	195°F
V-8, 7.3 L	2000	19202	CALEF. A BA	S/Calef. Auxiliar
		91967	EDH	PRESION
		22319	MANGUERA INF.	
		22312	MANGUERA SUP.	
		38053	POLEA	CON CANALES
		38028	POLEA	LISO
		38023	POLEA DEL TENSOR - LISA	
		K081213	SERPENTIN	C/Alt. Heavy Duty
		K081359	SERPENTIN	C/Doble Alt.
		31109	TAPON DE ACEITE	
		31406	TAPON DE RADIADOR	(16 lbs) Sin Palanca
		33909	TERMOSTATO	195°F
V-10, 6.8 L	1999	19191	CALEF. A TUBO-1	S/Calef. Auxiliar
		22371	MANGUERA INF.	
		22316	MANGUERA SUP.	
		38023	POLEA	LISO
		38022	POLEA	
		K080806	SERPENTIN	S/AA
		K080991	SERPENTIN	C/AA
		38133	SENSOR MICRO-V	C/AA
		38330	SENSOR MICRO-V	
V-8, 5.4 L	1999	22318	MANGUERA INF.	
		22315	MANGUERA SUP.	
		38053	POLEA	
		38023	POLEA DEL TENSOR - LISA	
		38022	POLEA LOCA	
		K080991	SERPENTIN	C/AA
		K080806	SERPENTIN	S/AA
		38133	SENSOR MICRO-V	C/AA
		38330	SENSOR MICRO-V	
V-8, 7.3 L	1999	19202	CALEF. A BA	S/Calef. Auxiliar
		22319	MANGUERA INF.	
		22312	MANGUERA SUP.	
		38028	POLEA	LISO
		38053	POLEA	CON CANALES
		38023	POLEA DEL TENSOR - LISA	
		K081359	SERPENTIN	C/Doble Alt.
		K081213	SERPENTIN	C/Alt. Heavy Duty

    				
		38006	POLEA LOCA	
		K060975	SERPENTIN	
		31109	TAPON DE ACEITE	
		31615	TAPON DE GASOLINA	SIN LLAVE C/CONT. DE EMIS
		31734	TAPON DE GASOLINA	CON LLAVE C/CONT. DE EMIS
		31406	TAPON DE RADIADOR	(16 lbs) Sin Palanca
		38132	SENSOR MICRO-V	
		33189	TERMOSTATO	195°F

**TRANSIT**

4 CIL, 2.2 L	2010	91030	HERRAMIENTA INST. STRECH F	
		T36124	POLEA	A.A.
		4PK922SF	SERPENTIN	D.H. STRECH FIT
		K060660	SERPENTIN	
		TH26988G1	TERMOSTATOS	190°
4 CIL, 2.2 L	2009	91030	HERRAMIENTA INST. STRECH F	
		T36124	POLEA	A.A.
		4PK922SF	SERPENTIN	D.H. STRECH FIT
		K060660	SERPENTIN	
		TH26988G1	TERMOSTATOS	190°
4 CIL, 2.2 L	2008	91030	HERRAMIENTA INST. STRECH F	
		T36124	POLEA	A.A.
		4PK922SF	SERPENTIN	D.H. STRECH FIT
		K060660	SERPENTIN	
4 CIL, 2.2 L TDI	2008	TH26988G1	TERMOSTATO	190°F

**WINDSTAR**

V-6, 3.8 L	2003	19736	CALEF. A "T"-1	C/Calefactor Auxiliar
		19692	CALEF. A "T"-2	C/Calefactor Auxiliar
		30T 5/8"	CALEF. AUXILIAR A TUBO	
		92112	EDH	PRESION
		22448	MANGUERA INF.	
		22286	MANGUERA SUP.	
		38008	POLEA DEL TENSOR	
		38001	POLEA LOCA	
		K060960	SERPENTIN	
		18916	T-1 A CALEF. AUXILIAR	
		19726	T-1 A MULTIPLE	C/Calefactor Auxiliar
		19739	T-2 A B.A.	C/Calefactor Auxiliar
		19103	T-2 A CALEF. AUXILIAR	
		19805	TANQUE DE RECUP. A RADIAD	C/ manguera de dia. 3/4"
		18225	TANQUE DE RECUP. A RADIAD	C/ manguera de dia. 3/8"
		18246	TANQUE DE RECUP. A TUBO	
		31109	TAPON DE ACEITE	
		31828	TAPON DE GASOLINA	CON LLAVE REGULAR
		31406	TAPON DE RADIADOR	(16 lbs) Sin Palanca
		38150	SENSOR MICRO-V	
		33009	TERMOSTATO	195°F
V-6, 3.8 L	2002	BDH-286	BOMBA DE DIR. HIDR.	
		19736	CALEF. A "T"-1	C/Calefactor Auxiliar
		19692	CALEF. A "T"-2	C/Calefactor Auxiliar
		30T 5/8"	CALEF. AUXILIAR A TUBO	
		92112	EDH	PRESION
		22448	MANGUERA INF.	
		22286	MANGUERA SUP.	
		38008	POLEA DEL TENSOR	
		38001	POLEA LOCA	
		K060960	SERPENTIN	
		18916	T-1 A CALEF. AUXILIAR	
		19726	T-1 A MULTIPLE	C/Calefactor Auxiliar
		19739	T-2 A B.A.	C/Calefactor Auxiliar
		19103	T-2 A CALEF. AUXILIAR	
		19805	TANQUE DE RECUP. A RADIAD	C/ manguera de dia. 3/4"
		18225	TANQUE DE RECUP. A RADIAD	C/ manguera de dia. 3/8"
		18246	TANQUE DE RECUP. A TUBO	
		31109	TAPON DE ACEITE	
		31828	TAPON DE GASOLINA	CON LLAVE REGULAR
		31830	TAPON DE GASOLINA	SIN LLAVE REGULAR
		31406	TAPON DE RADIADOR	(16 lbs) Sin Palanca
		38150	SENSOR MICRO-V	
		33009	TERMOSTATO	195°F
V-6, 3.8 L	2001	BDH-286	BOMBA DE DIR. HIDR.	
		19736	CALEF. A "T"-1	C/Calef. Auxiliar
		19692	CALEF. A "T"-2	C/Calef. Auxiliar

**THUNDERBIRD**

V-8, 4.6 L	1997	91836	EDH	PRESION
		22149	MANG. INF.	
		22044	MANG. SUP.	













V-6, 3.8 L	2001	92112 22448 22286 38008 38001 K060960 31109 31830 31828 31406 38150 33009	EDH MANGUERA INF. MANGUERA SUP. POLEA DEL TENSOR POLEA LOCA SERPENTIN TAPON DE ACEITE TAPON DE GASOLINA TAPON DE GASOLINA TAPON DE RADIADOR TENSOR MICRO-V TERMOSTATO	PRESION C/AA, C/DH C/AA, C/DH
V-6, 3.8 L	2000	BDH-286 19736 19692 92112 22448 22286 38008 38001 K060960 K060966 31109 31828 31830 31336 38150 33509	BOMBA DE DIR. HIDR. CALEF. A "T"-1 CALEF. A "T"-2 EDH MANGUERA INF. MANGUERA SUP. POLEA DEL TENSOR POLEA LOCA SERPENTIN SERPENTIN TAPON DE ACEITE TAPON DE GASOLINA TAPON DE GASOLINA TAPON DE RADIADOR TENSOR MICRO-V TERMOSTATO	195°F C/Calef. Auxiliar C/Calef. Auxiliar PRESION C/AA, C/DH C/AA, C/DH
V-6, 3.8 L	1999	BDH-286 19736 19692 92112 22448 22286 38008 38001 K060960 31109 31828 31830 31336 38150 33469	BOMBA DE DIR. HIDR. CALEF. A "T"-1 CALEF. A "T"-2 EDH MANGUERA INF. MANGUERA SUP. POLEA DEL TENSOR POLEA LOCA SERPENTIN TAPON DE ACEITE TAPON DE GASOLINA TAPON DE GASOLINA TAPON DE RADIADOR TENSOR MICRO-V TERMOSTATO	C/Calef. Auxiliar C/Calef. Auxiliar PRESION C/AA, C/DH C/AA, C/DH
V-6, 3.0 L	1998	92032 38006 38005 K060854 K060827 31109 31830 31336 38114 33009 33509	EDH POLEA POLEA LOCA SERPENTIN SERPENTIN TAPON DE ACEITE TAPON DE GASOLINA TAPON DE RADIADOR TENSOR MICRO-V TERMOSTATO TERMOSTATO	PRESION C/AA S/AA SIN LLAVE REGULAR (16 lbs) Sin Palanca 195°F 195°F
V-6, 3.8 L	1998	20900 22286 38009 38008 38001 K061031 31109 31830 31336 38139 33469	MANGUERA INF. MANGUERA SUP. POLEA POLEA DEL TENSOR POLEA LOCA SERPENTIN TAPON DE ACEITE TAPON DE GASOLINA TAPON DE RADIADOR TENSOR MICRO-V TERMOSTATO	C/AA C/AA C/AA C/AA
V-6, 3.8 L	1997	91980 20900 22286 38005 38009 K061031 31109 31615 31336 38139	EDH MANGUERA INF. MANGUERA SUP. POLEA POLEA DEL TENSOR SERPENTIN TAPON DE ACEITE TAPON DE GASOLINA TAPON DE RADIADOR TENSOR MICRO-V	PRESION C/AA C/AA C/AA C/AA SIN LLAVE REGULAR (16 lbs) Sin Palanca

<b>ZX2</b>				
4 CIL, 2.0 L	2003	TCK294A 38006 T42034 T42036 T43003 38162	KIT DE DISTRIBUCION POLEA POLEA BANDA DE TIEMPO POLEA BANDA DE TIEMPO TENSOR ARBOL DE LEVAS TENSOR MICRO-V	2000 - 2006 T42036 INFERIOR SUPERIOR
4 CIL, 2.0 L	2002	T294 19058 18951 354020(802)	BANDA ARBOL DE LEVAS CALEF. A TERMOSTATO CALEF. A TUBO-1 EDH	{129 D x 25.4 mm}
4 CIL, 2.0 L	2001	22346 22347 K060854 31828 31336 38162 T294 19058 18951 354020(802)	MANGUERA INF. MANGUERA SUP. SERPENTIN TAPON DE GASOLINA TAPON DE RADIADOR TENSOR MICRO-V BANDA ARBOL DE LEVAS CALEF. A TERMOSTATO CALEF. A TUBO-1 EDH	PRESION CON LLAVE REGULAR (16 lbs) Sin Palanca {129 D x 25.4 mm}
4 CIL, 2.0 L	2000	22346 22347 K060854 31117 31828 31336 38162 33339 354020(802)	MANGUERA INF. MANGUERA SUP. SERPENTIN TAPON DE ACEITE TAPON DE GASOLINA TAPON DE RADIADOR TENSOR MICRO-V TERMOSTATO EDH	PRESION CON LLAVE REGULAR (16 lbs) Sin Palanca 195°F PRESION
4 CIL, 2.0 L	2000	31117 31828 31336 33339	TAPON DE ACEITE TAPON DE GASOLINA TAPON DE RADIADOR TERMOSTATO	CON LLAVE REGULAR (16 lbs) Sin Palanca 195°F PRESION



## GMC











<b>ACADIA</b>				
V-6, 3.6 L	2010	23294 23293 K060938 31103 31843 31844 31532 38397	MANGUERA INF. MANGUERA SUP. SERPENTIN TAPON DE ACEITE TAPON DE GASOLINA TAPON DE GASOLINA TAPONES DE RADIADOR TENSOR	CON LLAVE 15 LBS.
V-6, 3.6 L	2009	23294 23293 K060938 31103 31844 31843 31532 38397	MANGUERA INF. MANGUERA SUP. SERPENTIN TAPON DE ACEITE TAPON DE GASOLINA TAPON DE GASOLINA TAPONES DE RADIADOR TENSOR	CON LLAVE 15 LBS.
V-6, 3.6 L	2008	K060938 31844 31843 38397	SERPENTIN TAPON DE GASOLINA TAPON DE GASOLINA TENSOR MICRO-V	CON LLAVE
V-6, 3.6 L	2007	K060938 31844 31843 38397	SERPENTIN TAPON DE GASOLINA TAPON DE GASOLINA TENSOR MICRO-V	CON LLAVE

<b>CANYON</b>				
5 CIL, 3.7 L	2010	22917 22129 36301 36101 K060915	MANGUERA INF. MANGUERA SUP. POLEA POLEA DEL TENSOR SERPENTIN	

    				    					
5 CIL, 3.7 L	2010	31103 31844 31843 31532 38178	TAPON DE ACEITE TAPON DE GASOLINA TAPON DE GASOLINA TAPONES DE RADIADOR TENSOR	CON LLAVE 15 LBS.	V-8, 6.2 L	2009	31844 31532 39083 33963 K040355SF	TAPON DE GASOLINA TAPONES DE RADIADOR TENSOR TERMOSTATOS A.A. STRECH FIT	CON LLAVE 15 LBS. 186°
5 CIL, 3.7 L	2009	22917 22129 36301 36101 K060915 31103 31844 31843 31532 38178	MANGUERA INF. MANGUERA SUP. POLEA POLEA DEL TENSOR SERPENTIN TAPON DE ACEITE TAPON DE GASOLINA TAPON DE GASOLINA TAPONES DE RADIADOR TENSOR	CON LLAVE 15 LBS.		2008	91030 22437 23184 36299 38009 K060935 31103 31843 31844 31532 39083 33963	HERRAMIENTA INST. STRECH F MANGUERA INF. MANGUERA SUP. POLEA POLEA DEL TENSOR SERPENTIN TAPON DE ACEITE TAPON DE GASOLINA TAPON DE GASOLINA TAPONES DE RADIADOR TENSOR	CON LLAVE 15 LBS. 186°
5 CIL, 3.7 L	2008	22917 22129 36101 K060915 31103 31844 31843 31532 38178 34045	MANGUERA INF. MANGUERA SUP. POLEA SERPENTIN TAPON DE ACEITE TAPON DE GASOLINA TAPON DE GASOLINA TAPON DE RADIADOR TENSOR MICRO-V TERMOSTATO	CON LLAVE 15 LIBRAS 180°F	V-8, 6.2 L	2007	K040378 22437 38001 38009 36169 K060935 38159 38158 K040378	A.A. MANGUERA INF. POLEA POLEA POLEA SERPENTIN TENSOR MICRO-V TENSOR MICRO-V A.A.	SERPENTIN SERPENTIN A/A A/A SERPENTIN
4 CIL, 2.9 L	2007	36101 38178	POLEA TENSOR MICRO-V		V-8, 6.2 L	2007	22554 22437 38009 38001 36169 K060935 38158 38159	MANGUERA CALEFACCION MANGUERA INF. POLEA POLEA POLEA SERPENTIN TENSOR MICRO-V TENSOR MICRO-V	SERPENTIN SERPENTIN A/A SERPENTIN SERPENTIN A/A
5 CIL, 3.7 L	2007	22917 22129 36101 K060915 31103 31844 31843 31532 38178 34045	MANGUERA INF. MANGUERA SUP. POLEA SERPENTIN TAPON DE ACEITE TAPON DE GASOLINA TAPON DE GASOLINA TAPON DE RADIADOR TENSOR MICRO-V TERMOSTATO	CON LLAVE 15 LIBRAS 180°F		2007	22437 38009 38001 36169 K060935 38158 38159	MANGUERA INF. POLEA POLEA POLEA SERPENTIN TENSOR MICRO-V TENSOR MICRO-V	SERPENTIN SERPENTIN A/A SERPENTIN SERPENTIN A/A

## YUKON











									
V-8, 5.3 L	2010	K040355SF 91030 22437 23184 36299 38009 K060935 31103 31844 31843 31532 39083 33963	A.A. STRECH FIT HERRAMIENTA INST. STRECH F MANGUERA INF. MANGUERA SUP. POLEA POLEA DEL TENSOR SERPENTIN TAPON DE ACEITE TAPON DE GASOLINA TAPON DE GASOLINA TAPONES DE RADIADOR TENSOR TERMOSTATOS	CON LLAVE 15 LBS. 186°	V-8, 6.2 L	2009	K040355SF 91030 22437 23184 36299 38009 K060935 31103 31844 31843 31532 39083 33963 K040355SF 91030 22437 23184 36299 38009 K060935 31103 31843 31844 31532 39083 33963	A.A. STRECH FIT HERRAMIENTA INST. STRECH F MANGUERA INF. MANGUERA SUP. POLEA POLEA DEL TENSOR SERPENTIN TAPON DE ACEITE TAPON DE GASOLINA TAPON DE GASOLINA TAPONES DE RADIADOR TENSOR TERMOSTATOS A.A. STRECH FIT HERRAMIENTA INST. STRECH F MANGUERA INF. MANGUERA SUP. POLEA POLEA DEL TENSOR SERPENTIN TAPON DE ACEITE TAPON DE GASOLINA TAPON DE GASOLINA TAPONES DE RADIADOR TENSOR TERMOSTATOS	CON LLAVE 15 LBS. 186°
V-8, 6.2 L	2010	K040355SF 91030 22437 23184 36299 38009 K060935 31103 31844 31843 31532 39083 33963	A.A. STRECH FIT HERRAMIENTA INST. STRECH F MANGUERA INF. MANGUERA SUP. POLEA POLEA DEL TENSOR SERPENTIN TAPON DE ACEITE TAPON DE GASOLINA TAPON DE GASOLINA TAPONES DE RADIADOR TENSOR TERMOSTATOS	CON LLAVE 15 LBS. 186°	V-8, 5.3 L	2008	K040378 22554 22437 38001 36169 38009 K060935 31103 31843 31844 31532 39083 33963	A.A. MANGUERA CALEFACCION MANGUERA INF. POLEA POLEA POLEA SERPENTIN TAPON DE ACEITE TAPON DE GASOLINA TAPON DE GASOLINA TAPON DE RADIADOR TENSOR TERMOSTATOS	SERPENTIN A/A SERPENTIN CON LLAVE 15 LIBRAS SERPENTIN
V-8, 5.3 L	2009	K040355SF 91030 22437 23184 36299 38009 K060935 31103 31843	A.A. STRECH FIT HERRAMIENTA INST. STRECH F MANGUERA INF. MANGUERA SUP. POLEA POLEA DEL TENSOR SERPENTIN TAPON DE ACEITE TAPON DE GASOLINA	CON LLAVE 15 LBS.		2008	38158	TENSOR MICRO-V	SERPENTIN

    				    					
V-8, 5.3 L	2008	38159 33963	TENSOR MICRO-V TERMOSTATO	A/A 186°F			31783 31637	TAPON DE GASOLINA TAPON DE GASOLINA	CON LLAVE
V-8, 6.2 L	2008	K040378 22437 38001 38009 36169 K060935 31532 38158 38159	A.A. MANGUERA INF. POLEA POLEA POLEA SERPENTIN TAPON DE RADIADOR TENSOR MICRO-V TENSOR MICRO-V	SERPENTIN SERPENTIN A/A 15 LIBRAS SERPENTIN A/A	4 CIL, 2.4 L	2008	19498 K070721 31284 31637 31783 31412 39073 34050	TAPONES DE RADIADOR TENSOR TENSOR HIDRAULICO TERMOSTATOS MANGUERA DE PASO SERPENTIN TAPON DE ACEITE TAPON DE GASOLINA TAPON DE GASOLINA TAPONES DE RADIADOR TENSOR	16 LBS. 170°
V-8, 5.3 L	2007	K040378 22554 22437 38001 38009 36169 K060935 31103 31843 31844 31532 38159 38158 33963	A.A. MANGUERA CALEFACCION MANGUERA INF. POLEA POLEA POLEA SERPENTIN TAPON DE ACEITE TAPON DE GASOLINA TAPON DE GASOLINA TAPON DE RADIADOR TENSOR MICRO-V TENSOR MICRO-V TERMOSTATO	SERPENTIN SERPENTIN A/A CON LLAVE 15 LIBRAS A/A SERPENTIN 186°F	V-6, 3.5 L	2008	T329 TCK329 23518 T41231 K060840 31783 31637 31412 39092 T41232 T43129 33914 K070701	BANDA ARBOL DE LEVAS KIT DE DISTRIBUCION MANGUERA SUP. POLEA DE DISTRIBUCION SERPENTIN TAPON DE GASOLINA TAPON DE GASOLINA TAPONES DE RADIADOR TENSOR TENSOR TENSOR HIDRAULICO TERMOSTATOS SERPENTIN	CON LLAVE 16 LBS. 172°
V-8, 6.2 L	2007	K040378 22554 22437 38001 36169 38009 K060935 31532 38159 38158	A.A. MANGUERA CALEFACCION MANGUERA INF. POLEA POLEA POLEA SERPENTIN TAPON DE RADIADOR TENSOR MICRO-V TENSOR MICRO-V	SERPENTIN A/A SERPENTIN 15 LIBRAS A/A SERPENTIN	V-6, 3.0 L	2007	T329 36112 K060840 31109 31832 31412 T41232 38332 K070701	BANDA ARBOL DE LEVAS POLEA SERPENTIN TAPON DE ACEITE TAPON DE GASOLINA TAPON DE RADIADOR TENSOR ARBOL DE LEVAS TENSOR MICRO-V SERPENTIN TAPON DE ACEITE TAPON DE GASOLINA TAPON DE RADIADOR TENSOR MICRO-V	CON LLAVE 16 LBS. 170° CON LLAVE REGULAR (16 lbs) Sin Palanca

**HONDA**

**ACCORD**

4 CIL, 2.4 L	2010	19498 K070721 31284 31637 31783 31412 39073 34050	MANGUERA DE PASO SERPENTIN TAPON DE ACEITE TAPON DE GASOLINA TAPON DE GASOLINA TAPONES DE RADIADOR TENSOR TERMOSTATOS	CON LLAVE 16 LBS. 172°	V-6, 3.0 L	2006	T329 36112 K060840 31109 31832 31412 T41232 38332 K070701	BANDA ARBOL DE LEVAS POLEA SERPENTIN TAPON DE ACEITE TAPON DE GASOLINA TAPON DE RADIADOR TENSOR MICRO-V SERPENTIN TAPON DE ACEITE TAPON DE GASOLINA TAPON DE RADIADOR TENSOR MICRO-V	CON LLAVE REGULAR (16 lbs) Sin Palanca
V-6, 3.5 L	2010	T329 TCK329 23518 T41231 K060840 31783 31637 31412 T41232 39092 T43129 33914	BANDA ARBOL DE LEVAS KIT DE DISTRIBUCION MANGUERA SUP. POLEA DE DISTRIBUCION SERPENTIN TAPON DE GASOLINA TAPON DE GASOLINA TAPONES DE RADIADOR TENSOR TENSOR TENSOR HIDRAULICO TERMOSTATOS	CON LLAVE 16 LBS. 170°	4 CIL, 2.4 L	2005	K070701 31284 31637 31412 38278 T329 36112 K060840 31109 31832 31412 T41232 38332 K070701	BANDA ARBOL DE LEVAS POLEA SERPENTIN TAPON DE ACEITE TAPON DE GASOLINA TAPON DE RADIADOR TENSOR MICRO-V SERPENTIN TAPON DE ACEITE TAPON DE GASOLINA TAPON DE RADIADOR TENSOR MICRO-V	SIN LLAVE REGULAR (16 lbs) Sin Palanca
4 CIL, 2.4 L	2009	19498 K070721 31284 31637 31783 31412 39073 34050	MANGUERA DE PASO SERPENTIN TAPON DE ACEITE TAPON DE GASOLINA TAPONES DE RADIADOR TENSOR TERMOSTATOS	CON LLAVE 16 LBS. 172°	4 CIL, 2.4 L	2004	T329 TCK329 23518 T41231 K060840	BANDA ARBOL DE LEVAS KIT DE DISTRIBUCION MANGUERA SUP. POLEA DE DISTRIBUCION SERPENTIN	SIN LLAVE REGULAR (16 lbs) Sin Palanca
V-6, 3.5 L	2009	T329 TCK329 23518 T41231 K060840	BANDA ARBOL DE LEVAS KIT DE DISTRIBUCION MANGUERA SUP. POLEA DE DISTRIBUCION SERPENTIN	CON LLAVE 16 LBS. 172°	V-6, 3.0 L	2004	T329 36112 K060840	BANDA ARBOL DE LEVAS POLEA SERPENTIN	CON LLAVE REGULAR (16 lbs) Sin Palanca {197 D x 20 mm}

    		    					
V-6, 3.0 L	2004	31109 TAPON DE ACEITE 31780 TAPON DE GASOLINA 31832 TAPON DE GASOLINA 31412 TAPON DE RADIADOR 38332 TENSOR MICRO-V	CON LLAVE REGULAR SIN LLAVE REGULAR (16 lbs) Sin Palanca	38001 POLEA DEL TENSOR 31109 TAPON DE ACEITE 31780 TAPON DE GASOLINA 31832 TAPON DE GASOLINA 31412 TAPON DE RADIADOR T41090 TENSOR ARBOL DE LEVAS 38169 TENSOR MICRO-V 33877 TERMOSTATO	POLEA DEL TENSOR TAPON DE ACEITE TAPON DE GASOLINA TAPON DE GASOLINA TAPON DE RADIADOR TENSOR ARBOL DE LEVAS TENSOR MICRO-V TERMOSTATO	CON LLAVE REGULAR SIN LLAVE REGULAR (16 lbs) Sin Palanca	CON LLAVE REGULAR SIN LLAVE REGULAR (16 lbs) Sin Palanca
4 CIL, 2.4 L	2003	K070701 SERPENTIN 31780 TAPON DE GASOLINA 31832 TAPON DE GASOLINA 31412 TAPON DE RADIADOR 38278 TENSOR MICRO-V	CON LLAVE REGULAR SIN LLAVE REGULAR (16 lbs) Sin Palanca	4 CIL, 2.3 L 2000 K060435 ALT. & A.A. K060433 ALT. T244 BANDA ARBOL DE LEVAS T186 BANDA ARBOL DE LEVAS 19045 CALEF. A MOTOR K040418 D.H. TCK244 KIT DE DISTRIBUCION 22339 MANGUERA INF. 22338 MANGUERA SUP. 31109 TAPON DE ACEITE 31832 TAPON DE GASOLINA 31780 TAPON DE GASOLINA 31412 TAPON DE RADIADOR T41013 TENSOR ARBOL DE LEVAS T41014 TENSOR ARBOL DE LEVAS 33568 TERMOSTATO 19044 VALVULA-1 A MULTIPLE	ALT. Y A.A. 170°F C/AA, C/DH C/AA, C/DH PRESION C/MOTOR VTEC SIN LLAVE REGULAR CON LLAVE REGULAR (16 lbs) Sin Palanca C/AA, C/DH C/AA, C/DH D.H.		
V-6, 3.0 L	2003	36112 POLEA K060840 SERPENTIN 31109 TAPON DE ACEITE 31780 TAPON DE GASOLINA 31832 TAPON DE GASOLINA 31412 TAPON DE RADIADOR 38332 TENSOR MICRO-V 33914 TERMOSTATO	CON LLAVE REGULAR SIN LLAVE REGULAR (16 lbs) Sin Palanca	2000 K060435 ALT. & A.A. T244 BANDA ARBOL DE LEVAS T186 BANDA ARBOL DE LEVAS 19045 CALEF. A MOTOR 30T 5/8" CALEF. A VALVULA-1 K040418 D.H. TCK244 KIT DE DISTRIBUCION 22339 MANGUERA INF. 22338 MANGUERA SUP. 31109 TAPON DE ACEITE 31832 TAPON DE GASOLINA 31780 TAPON DE GASOLINA 31412 TAPON DE RADIADOR T41013 TENSOR ARBOL DE LEVAS T41014 TENSOR ARBOL DE LEVAS 33568 TERMOSTATO 19044 VALVULA-1 A MULTIPLE	ALT. & A.A. BANDA ARBOL DE LEVAS BANDA ARBOL DE LEVAS CALEF. A MOTOR CALEF. A VALVULA-1 D.H. KIT DE DISTRIBUCION MANGUERA INF. MANGUERA SUP. TAPON DE ACEITE TAPON DE GASOLINA TAPON DE GASOLINA TAPON DE RADIADOR TENSOR ARBOL DE LEVAS TENSOR ARBOL DE LEVAS TERMOSTATO VALVULA-1 A MULTIPLE	CON LLAVE REGULAR SIN LLAVE REGULAR (16 lbs) Sin Palanca	170°F (70 D x 16.0 mm) V-6, 3.0 L 2000 K060461 ALT., A.A. T286 BANDA ARBOL DE LEVAS 19699 CALEF. A TERMOSTATO 30T 5/8" CALEF. A VALVULA-1 K040438 D.H. 22341 MANGUERA INF. 22340 MANGUERA SUP. 38001 POLEA DEL TENSOR 31109 TAPON DE ACEITE 31832 TAPON DE GASOLINA 31780 TAPON DE GASOLINA 31412 TAPON DE RADIADOR 38169 TENSOR MICRO-V 33877 TERMOSTATO 18227 TUBO-1 A TUBO-2 18219 TUBO-2 A VALVULA REG. DE Aire 18010 VALV. REG. DE AIRE A TUBO 3
4 CIL, 2.3 L	2002	K060435 ALT., A.A. T244 BANDA ARBOL DE LEVAS T186 BANDA ARBOL DE LEVAS 19045 CALEF. A MOTOR 30T 5/8" CALEF. A VALVULA-1 K040418 D.H. TCK244 KIT DE DISTRIBUCION 22339 MANGUERA INF. 22338 MANGUERA SUP. 31109 TAPON DE ACEITE 31832 TAPON DE GASOLINA 31780 TAPON DE GASOLINA 31412 TAPON DE RADIADOR T41013 TENSOR ARBOL DE LEVAS T41014 TENSOR ARBOL DE LEVAS 33568 TERMOSTATO 19044 VALVULA-1 A MULTIPLE	SIN LLAVE REGULAR CON LLAVE REGULAR (16 lbs) Sin Palanca	V-6, 3.0 L 2000 K060461 ALT., A.A. T286 BANDA ARBOL DE LEVAS 19699 CALEF. A TERMOSTATO 30T 5/8" CALEF. A VALVULA-1 K040438 D.H. 22341 MANGUERA INF. 22340 MANGUERA SUP. 38001 POLEA DEL TENSOR 31109 TAPON DE ACEITE 31832 TAPON DE GASOLINA 31780 TAPON DE GASOLINA 31412 TAPON DE RADIADOR 38169 TENSOR MICRO-V 33877 TERMOSTATO	SIN LLAVE REGULAR CON LLAVE REGULAR (16 lbs) Sin Palanca C/AA, C/DH D.H. SIN LLAVE REGULAR CON LLAVE REGULAR (16 lbs) Sin Palanca ALT. Y A.A. 170°F C/AA, C/DH PRESION C/MOTOR VTEC		
V-6, 3.0 L	2002	K060461 ALT., A.A. T286 BANDA ARBOL DE LEVAS 19699 CALEF. A TERMOSTATO 30T 5/8" CALEF. A VALVULA-1 K040438 D.H. 22341 MANGUERA INF. 22340 MANGUERA SUP. 38001 POLEA DEL TENSOR 31109 TAPON DE ACEITE 31832 TAPON DE GASOLINA 31780 TAPON DE GASOLINA 31412 TAPON DE RADIADOR 38169 TENSOR MICRO-V 33877 TERMOSTATO 18227 TUBO-1 A TUBO-2 18219 TUBO-2 A VALVULA REG. DE Aire 18010 VALV. REG. DE AIRE A TUBO 3	SIN LLAVE REGULAR CON LLAVE REGULAR (16 lbs) Sin Palanca ALT. Y A.A. 170°F	4 CIL, 2.3 L 1999 K060435 ALT. & A.A. K060433 ALT. T244 BANDA ARBOL DE LEVAS T186 BANDA ARBOL DE LEVAS 19045 CALEF. A MOTOR K040418 D.H. K040415 D.H. 80268 EDH TCK244 KIT DE DISTRIBUCION 22339 MANGUERA INF. 22338 MANGUERA SUP. 31109 TAPON DE ACEITE 31832 TAPON DE GASOLINA 31780 TAPON DE GASOLINA 31412 TAPON DE RADIADOR T41013 TENSOR ARBOL DE LEVAS T41014 TENSOR ARBOL DE LEVAS 33568 TERMOSTATO	ALT. & A.A. ALT. BANDA ARBOL DE LEVAS BANDA ARBOL DE LEVAS CALEF. A MOTOR D.H. D.H. EDH KIT DE DISTRIBUCION MANGUERA INF. MANGUERA SUP. TAPON DE ACEITE TAPON DE GASOLINA TAPON DE GASOLINA TAPON DE RADIADOR TENSOR ARBOL DE LEVAS TENSOR ARBOL DE LEVAS TERMOSTATO	180°F V-6, 3.0 L 1999 K060461 ALT. T286 BANDA ARBOL DE LEVAS 19699 CALEF. A TERMOSTATO D.H. D.H. KIT DE DISTRIBUCION MANGUERA INF. MANGUERA SUP. POLEA BANDA DE TIEMPO POLEA DEL TENSOR TAPON DE ACEITE TAPON DE GASOLINA TAPON DE GASOLINA TAPON DE RADIADOR TENSOR ARBOL DE LEVAS	
4 CIL, 2.3 L	2001	K060435 ALT. & A.A. T244 BANDA ARBOL DE LEVAS T186 BANDA ARBOL DE LEVAS 19045 CALEF. A MOTOR K040418 D.H. TCK244 KIT DE DISTRIBUCION 22339 MANGUERA INF. 22338 MANGUERA SUP. 31109 TAPON DE ACEITE 31832 TAPON DE GASOLINA 31780 TAPON DE GASOLINA 31412 TAPON DE RADIADOR T41013 TENSOR ARBOL DE LEVAS T41014 TENSOR ARBOL DE LEVAS 33568 TERMOSTATO	SIN LLAVE REGULAR CON LLAVE REGULAR (16 lbs) Sin Palanca	V-6, 3.0 L 1999 K060461 ALT. T286 BANDA ARBOL DE LEVAS 19699 CALEF. A TERMOSTATO D.H. D.H. KIT DE DISTRIBUCION MANGUERA INF. MANGUERA SUP. POLEA BANDA DE TIEMPO POLEA DEL TENSOR TAPON DE ACEITE TAPON DE GASOLINA TAPON DE GASOLINA TAPON DE RADIADOR TENSOR ARBOL DE LEVAS	SIN LLAVE REGULAR CON LLAVE REGULAR (16 lbs) Sin Palanca 180°F C/AA, C/DH C/AA, C/DH C/AA, C/DH CON LLAVE REGULAR SIN LLAVE REGULAR (16 lbs) Sin Palanca		
V-6, 3.0 L	2001	K060461 ALT. & A.A. T286 BANDA ARBOL DE LEVAS 19699 CALEF. A TERMOSTATO K040438 D.H. TCK286 KIT DE DISTRIBUCION 22341 MANGUERA INF. 22340 MANGUERA SUP. T42038 POLEA BANDA DE TIEMPO 38001 POLEA DEL TENSOR 31109 TAPON DE ACEITE 31780 TAPON DE GASOLINA 31832 TAPON DE GASOLINA 31412 TAPON DE RADIADOR T41090 TENSOR ARBOL DE LEVAS	180°F	1999 K060461 ALT. T286 BANDA ARBOL DE LEVAS 19699 CALEF. A TERMOSTATO D.H. D.H. KIT DE DISTRIBUCION MANGUERA INF. MANGUERA SUP. POLEA BANDA DE TIEMPO POLEA DEL TENSOR TAPON DE ACEITE TAPON DE GASOLINA TAPON DE GASOLINA TAPON DE RADIADOR TENSOR ARBOL DE LEVAS	CON LLAVE REGULAR SIN LLAVE REGULAR (16 lbs) Sin Palanca		



V-6, 3.0 L	1999	38169 33877	TENSOR MICRO-V TERMOSTATO	ALT. Y A.A. 170°F											
4 CIL, 2.3 L	1998	K060415 T244 K040420 TCK244 22339 22338 T41013 T41014	ALT. BANDA ARBOL DE LEVAS D.H. KIT DE DISTRIBUCION MANGUERA INF. MANGUERA SUP. TENSOR ARBOL DE LEVAS TENSOR ARBOL DE LEVAS	{112 D x 24.0 mm} SOHC VTEC											
V-6, 3.0 L	1998	K060461 T286 K040440 TCK286 22341 22340 T42038 38001 T41090 38169 33877	ALT. BANDA ARBOL DE LEVAS D.H. KIT DE DISTRIBUCION MANGUERA INF. MANGUERA SUP. POLEA BANDA DE TIEMPO POLEA DEL TENSOR TENSOR ARBOL DE LEVAS TENSOR MICRO-V TERMOSTATO	C/AA, C/DH C/AA, C/DH ALT. Y A.A. 170°F	4 CIL, 1.7 L										
<b>CITY</b>															
4 CIL, 1.5 L	2010	K050448 31284 31637 31783 31412 335685	SERPENTIN TAPON DE ACEITE TAPON DE GASOLINA TAPON DE GASOLINA TAPONES DE RADIADOR TERMOSTATOS	CON LLAVE 16 LBS. 180°	4 CIL, 1.7 L										
<b>CIVIC</b>															
4 CIL, 1.8 L	2010	19552 19550 23342 23326 K070855 31284 31783 31637 31412 39077 365685	MANGUERA CALEFACCION MANGUERA CALEFACCION MANGUERA INF. MANGUERA SUP. SERPENTIN TAPON DE ACEITE TAPON DE GASOLINA TAPON DE GASOLINA TAPONES DE RADIADOR TENSOR TERMOSTATOS	ENTRADA SALIDA CON LLAVE 16 LBS. 180°	4 CIL, 1.7 L										
4 CIL, 1.8 L	2009	19550 19552 23342 23326 K070855 31284 31637 31783 31412 39077 365685	MANGUERA CALEFACCION MANGUERA CALEFACCION MANGUERA INF. MANGUERA SUP. SERPENTIN TAPON DE ACEITE TAPON DE GASOLINA TAPON DE GASOLINA TAPONES DE RADIADOR TENSOR TERMOSTATOS	SALIDA ENTRADA CON LLAVE 16 LBS. 180°	4 CIL, 1.6 L										
4 CIL, 1.8 L	2008	19550 19552 23342 23326 K070855 31284 31783 31637 31412 39077 365685	MANGUERA CALEFACCION MANGUERA CALEFACCION MANGUERA INF. MANGUERA SUP. SERPENTIN TAPON DE ACEITE TAPON DE GASOLINA TAPON DE GASOLINA TAPONES DE RADIADOR TENSOR TERMOSTATOS	SALIDA ENTRADA CON LLAVE 16 LBS. 180°	4 CIL, 1.6 L										
4 CIL, 1.8 L	2007	K070855 31284 31637 31412	SERPENTIN TAPON DE ACEITE TAPON DE GASOLINA TAPON DE RADIADOR	SIN LLAVE REGULAR (16 lbs) Sin Palanca											
4 CIL, 1.8 L	2006	K070855 31284 31637 31412	SERPENTIN TAPON DE ACEITE TAPON DE GASOLINA TAPON DE RADIADOR	SIN LLAVE REGULAR (16 lbs) Sin Palanca	4 CIL, 1.6 L										
4 CIL, 1.7 L	2005	T312 19332	BANDA ARBOL DE LEVAS MANG. CALEF. A MOTOR	MOTOR DE INTEFASE											
		22830 19331 22829 19330 19329 K040398 K060338 K060388 31284 31832 31412 T312 22830 22829 19329 19331 19330 19332 31284 31832 31780 31412 K040398 K060388 K060338 K060388 T312 K040398 22830 22829 31109 31780 31832 31412 K060388 T312 K040398 31109 31780 31832 31412 K060388 T312 K040398 31109 31780 31832 31412 T312 K040398 K060388 31109 31780 31832 31412 K040319 K040315 K040305 T224 18748 18792 K040345 K040330 80267 TCK224 TCK227 22323 21404 19042 31109 31832 31780 31412 T41016 T41023 33568 K040319 K040305 K040315 T224	MANG. INF. MANG. JUNTA DE AGUA MANG. SUP. MANG. VALVULA MANG. VALVULA A MOTOR SERPENTIN SERPENTIN SERPENTIN TAPON DE ACEITE TAPON DE GASOLINA TAPON DE RADIADOR BANDA ARBOL DE LEVAS MANG. INF. MANG. SUP. MANGUERA DE CALEFACCION MANGUERA DE CALEFACCION MANGUERA DE CALEFACCION MANGUERA DE CALEFACCION TAPON DE ACEITE TAPON DE GASOLINA TAPON DE GASOLINA TAPON DE RADIADOR BANDA ARBOL DE LEVAS D.H. TRANSMISION DE ACCESORIOS TRANSMISION DE ACCESORIOS ALT., A.A. ALT., SIN A.A. BANDA ARBOL DE LEVAS D.H. MANG. INF. MANG. SUP. TAPON DE ACEITE TAPON DE GASOLINA TAPON DE GASOLINA TAPON DE RADIADOR ALT., A.A. D.H. TAPON DE ACEITE TAPON DE GASOLINA TAPON DE GASOLINA TAPON DE RADIADOR BANDA ARBOL DE LEVAS SERPENTIN SERPENTIN TAPON DE ACEITE TAPON DE GASOLINA TAPON DE GASOLINA TAPON DE RADIADOR TERMOSTATO A.A. ALT. ALT. BANDA ARBOL DE LEVAS CALEF. A TUBO CALEF. A VALVULA D.H. D.H. EDH KIT DE DISTRIBUCION KIT DE DISTRIBUCION MANGUERA INF. MANGUERA SUP. PASO TAPON DE ACEITE TAPON DE GASOLINA TAPON DE GASOLINA TAPON DE RADIADOR TENSOR ARBOL DE LEVAS TENSOR ARBOL DE LEVAS TERMOSTATO A.A. ALT. ALT. BANDA ARBOL DE LEVAS	JUNTA DE AGUA C/4 VIAS S/CVT D.H. ALT., S/AA ALT., C/AA SIN LLAVE REGULAR (16 lbs) Sin Palanca {104 D x 22.0 mm} VALVULA A MOTOR; S/CVT JUNTA DE AGUA DE 4 VIAS A VALVULA A JUNTA DE AGUA CALEFACTOR A MOTOR SIN LLAVE REGULAR CON LLAVE REGULAR (16 lbs) Sin Palanca D.H. ALTERNADOR, A.A. ALTERNADOR, SIN A.A. {104 D x 22.0 mm} CON LLAVE REGULAR SIN LLAVE REGULAR (16 lbs) Sin Palanca MOTOR DE INTERFASE D.H. ALT., A.A. CON LLAVE REGULAR SIN LLAVE REGULAR (16 lbs) Sin Palanca 180°F C/DH SOHC DOHC {104 D x 22.0 mm} DX, HX Exc. Si DOHC SOHC PRESION HX SIN LLAVE REGULAR CON LLAVE REGULAR (16 lbs) Sin Palanca 180°F C/DH C/AA, C/DH C/AA, C/DH {104 D x 22.0 mm}											

4 CIL, 1.6 L	1999	18748	CALEF. A TUBO	DX, HX
		18792	CALEF. A VALVULA	Exc. Si
		K040330	D.H.	C/AA, C/DH
		K040345	D.H.	C/AA, C/DH
		80267	EDH	PRESION
		TCK224	KIT DE DISTRIBUCION	
		TCK227	KIT DE DISTRIBUCION	
		22323	MANGUERA INF.	
		21404	MANGUERA SUP.	
		25150	MANGUERA SUP.	
		19042	PASO	Exc. Si
		38030	POLEA	HX
		31109	TAPON DE ACEITE	A.A.
		31832	TAPON DE GASOLINA	SIN LLAVE REGULAR
		31780	TAPON DE GASOLINA	CON LLAVE REGULAR
		31412	TAPON DE RADIADOR	(16 lbs) Sin Palanca
		T41016	SENSOR ARBOL DE LEVAS	
T41023	SENSOR ARBOL DE LEVAS			
33568	TERMOSTATO	180°F		
4 CIL, 1.6 L	1998	K040325	A.A.	
		K040315	ALT.	C/AA
		T224	BANDA ARBOL DE LEVAS	{104 D x 22.0 mm}
		K040335	D.H.	C/AA
		80267	EDH	PRESION
		TCK224	KIT DE DISTRIBUCION	
		22323	MANGUERA INF.	
		21404	MANGUERA SUP.	
		38030	POLEA LOCA	
		31109	TAPON DE ACEITE	
		31832	TAPON DE GASOLINA	SIN LLAVE REGULAR
		31412	TAPON DE RADIADOR	(16 lbs) Sin Palanca
		T41023	SENSOR ARBOL DE LEVAS	
		33568	TERMOSTATO	180°F
		T224	BANDA ARBOL DE LEVAS	{104 D x 22.0 mm}
		TCK224	KIT DE DISTRIBUCION	
		22323	MANGUERA INF.	
21404	MANGUERA SUP.			
38030	POLEA	A.A.		
T41023	SENSOR ARBOL DE LEVAS			











4 CIL, 1.3 L	2006	K040630	SERPENTIN			
		31284	TAPON DE ACEITE			
		31637	TAPON DE GASOLINA	SIN LLAVE REGULAR		
		31412	TAPON DE RADIADOR	(16 lbs) Sin Palanca		
		39070	SENSOR			
		33568	TERMOSTATOS	180°		
		23327	MANGUERA INF.			
		23332	MANGUERA INF.			
		23341	MANGUERA SUP.			
		K040630	SERPENTIN			
		31284	TAPON DE ACEITE			
		31637	TAPON DE GASOLINA	SIN LLAVE REGULAR		
		31412	TAPON DE RADIADOR	(16 lbs) Sin Palanca		
		39070	SENSOR			
		33568	TERMOSTATOS	180°		
		4 CIL, 1.3 L	2005	23327	MANGUERA INF.	
				23332	MANGUERA INF.	
23341	MANGUERA SUP.					
K040630	SERPENTIN					
31284	TAPON DE ACEITE					
31637	TAPON DE GASOLINA			SIN LLAVE REGULAR		
31412	TAPON DE RADIADOR			(16 lbs) Sin Palanca		
39070	SENSOR					
33568	TERMOSTATOS			180°		

**CR-V**

4 CIL, 2.4 L	2009	19498	MANGUERA DE PASO	
		23389	MANGUERA INF.	
		23388	MANGUERA SUP.	
		K070690	SERPENTIN	
		31284	TAPON DE ACEITE	
		31783	TAPON DE GASOLINA	CON LLAVE
		31637	TAPON DE GASOLINA	
		31412	TAPONES DE RADIADOR	16 LBS.
		38278	SENSOR	
		34048	TERMOSTATOS	172°
		19498	MANGUERA DE PASO	
		23389	MANGUERA INF.	
		23388	MANGUERA SUP.	
		K070690	SERPENTIN	
		31284	TAPON DE ACEITE	
		31637	TAPON DE GASOLINA	CON LLAVE
		31783	TAPON DE GASOLINA	
31412	TAPONES DE RADIADOR	16 LBS.		
38278	SENSOR			
34048	TERMOSTATOS	172°		
4 CIL, 2.4 L	2008	19498	MANGUERA DE PASO	
		23389	MANGUERA INF.	
		23388	MANGUERA SUP.	
		K070690	SERPENTIN	
		31284	TAPON DE ACEITE	
		31637	TAPON DE GASOLINA	CON LLAVE
		31783	TAPON DE GASOLINA	
		31412	TAPONES DE RADIADOR	16 LBS.
		38278	SENSOR	
		34048	TERMOSTATO	172°F
		19339	MANG. DE PASO	
		22849	MANG. INF.	
		22848	MANG. SUP.	
		22849	MANGUERA INF.	
		22848	MANGUERA SUP.	
		K070683	SERPENTIN	
		31284	TAPON DE ACEITE	
31637	TAPON DE GASOLINA	SIN LLAVE REGULAR		
31412	TAPON DE RADIADOR	(16 lbs) Sin Palanca		
38278	SENSOR MICRO-V			
22849	MANG. INF.			
22848	MANG. SUP.			
22849	MANGUERA INF.			
22848	MANGUERA SUP.			
K070683	SERPENTIN			
31637	TAPON DE GASOLINA	SIN LLAVE REGULAR		
31412	TAPON DE RADIADOR	(16 lbs) Sin Palanca		
38278	SENSOR MICRO-V			
22849	MANGUERA INF.			











**CIVIC HIBRIDO**

4 CIL, 1.3 L	2010	23332	MANGUERA INF.			
		23327	MANGUERA INF.			
		23341	MANGUERA SUP.			
		K040630	SERPENTIN			
		31284	TAPON DE ACEITE			
		31783	TAPON DE GASOLINA	CON LLAVE		
		31637	TAPON DE GASOLINA			
		31412	TAPONES DE RADIADOR	16 LBS.		
		39070	SENSOR			
		33568	TERMOSTATOS	180°		
		4 CIL, 1.3 L	2009	23332	MANGUERA INF.	
				23327	MANGUERA INF.	
				23341	MANGUERA SUP.	
				K040630	SERPENTIN	
				31284	TAPON DE ACEITE	
				31783	TAPON DE GASOLINA	CON LLAVE
				31637	TAPON DE GASOLINA	
31412	TAPONES DE RADIADOR			16 LBS.		
39070	SENSOR					
33568	TERMOSTATOS			180°		
4 CIL, 1.3 L	2008			23327	MANGUERA INF.	
				23332	MANGUERA INF.	
				23341	MANGUERA SUP.	
				K040630	SERPENTIN	
				31284	TAPON DE ACEITE	
				31783	TAPON DE GASOLINA	CON LLAVE
				31637	TAPON DE GASOLINA	
		31412	TAPONES DE RADIADOR	16 LBS.		
		39070	SENSOR			
		33568	TERMOSTATOS	180°		
		4 CIL, 1.3 L	2007	23332	MANGUERA INF.	
				23327	MANGUERA INF.	
				23341	MANGUERA SUP.	
				K040630	SERPENTIN	
				31284	TAPON DE ACEITE	
				31783	TAPON DE GASOLINA	CON LLAVE
				31637	TAPON DE GASOLINA	
31412	TAPONES DE RADIADOR			16 LBS.		
39070	SENSOR					
33568	TERMOSTATOS			180°		

    				    					
4 CIL, 2.4 L	2004	22848	MANGUERA SUP.	CON LLAVE REGULAR SIN LLAVE REGULAR (16 lbs) Sin Palanca	4 CIL, 1.5 L	2010	K050448	SERPENTIN	CON LLAVE 16 LBS. 180°
		K070683	SERPENTIN				31284	TAPON DE ACEITE	
		31284	TAPON DE ACEITE				31783	TAPON DE GASOLINA	
		31780	TAPON DE GASOLINA				31637	TAPON DE GASOLINA	
		31832	TAPON DE GASOLINA				31412	TAPONES DE RADIADOR	
		31412	TAPON DE RADIADOR				335685	TERMOSTATOS	
		38278	SENSOR MICRO-V				K050448	SERPENTIN	
		K070683	SERPENTIN				31284	TAPON DE ACEITE	
		31832	TAPON DE GASOLINA				31637	TAPON DE GASOLINA	
		31780	TAPON DE GASOLINA				31783	TAPON DE GASOLINA	
4 CIL, 2.0 L	2003	31412	TAPON DE RADIADOR	SIN LLAVE REGULAR CON LLAVE REGULAR (16 lbs) Sin Palanca	4 CIL, 1.5 L	2009	K050448	SERPENTIN	CON LLAVE 16 LBS. 180°
		22848	MANG. SUP.				31637	TAPON DE GASOLINA	
		K070683	SERPENTIN				31412	TAPONES DE RADIADOR	
		31412	TAPON DE RADIADOR				335685	TERMOSTATOS	
4 CIL, 2.0 L	2002	22848	MANG. SUP.	SIN LLAVE REGULAR CON LLAVE REGULAR (16 lbs) Sin Palanca	4 CIL, 1.5 L	2008	K050450	SERPENTIN	16 LIBRAS
		K070683	SERPENTIN				31284	TAPON DE ACEITE	
		31284	TAPON DE ACEITE				31637	TAPON DE GASOLINA	
		31832	TAPON DE GASOLINA				31412	TAPON DE GASOLINA	
		31780	TAPON DE GASOLINA				31412	TAPONES DE RADIADOR	
		31412	TAPON DE RADIADOR				335685	TERMOSTATOS	
		33949	TERMOSTATO				K050450	SERPENTIN	
		K040332	A.A.				31284	TAPON DE ACEITE	
		K040322	ALT.				31637	TAPON DE GASOLINA	
		T184	BANDA ARBOL DE LEVAS				31412	TAPON DE RADIADOR	
4 CIL, 2.0 L	2001	19176	CALEF. A MOTOR	{125 D x 26.0 mm}	4 CIL, 1.5 L	2007	K050450	SERPENTIN	16 LIBRAS
		18802	CALEF. A VALVULA-1				31284	TAPON DE ACEITE	
		K040353	D.H.				31637	TAPON DE GASOLINA	
		TCK184	KIT DE DISTRIBUCION				31412	TAPON DE RADIADOR	
		21871	MANGUERA INF.				K050450	SERPENTIN	
		22322	MANGUERA SUP.				31284	TAPON DE ACEITE	
		18701	PASO				31637	TAPON DE GASOLINA	
		18700	PASO				31412	TAPON DE RADIADOR	
		38030	POLEA				C/Trans Auto		
		31109	TAPON DE ACEITE				C/Trans manual		
31780	TAPON DE GASOLINA	A.A.							
31832	TAPON DE GASOLINA	CON LLAVE REGULAR							
31412	TAPON DE RADIADOR	SIN LLAVE REGULAR							
T41016	SENSOR ARBOL DE LEVAS	(16 lbs) Sin Palanca							
33568	TERMOSTATO	170°F							
4 CIL, 2.0 L	2000	K040332	A.A.	{125 D x 26.0 mm}	V-6, 3.5 L	2010	T329	BANDA ARBOL DE LEVAS	VERSION EXL, TOURING VERSION EX, LX MOTOR J35A6 MOTOR J35A6
		K040322	ALT.				TCK329	KIT DE DISTRIBUCION	
		T184	BANDA ARBOL DE LEVAS				23391	MANGUERA INF.	
		19176	CALEF. A MOTOR				23517	MANGUERA SUP.	
		18802	CALEF. A VALVULA-1				23390	MANGUERA SUP.	
		K040353	D.H.				36112	POLEA	
		TCK184	KIT DE DISTRIBUCION				36112	POLEA	
		21871	MANGUERA INF.				T41231	POLEA DE DISTRIBUCION	
		22322	MANGUERA SUP.				K060840	SERPENTIN	
		18701	PASO				31284	TAPON DE ACEITE	
18700	PASO	31637	TAPON DE GASOLINA						
38030	POLEA	31783	TAPON DE GASOLINA						
31109	TAPON DE ACEITE	31412	TAPONES DE RADIADOR						
31832	TAPON DE GASOLINA	38332	SENSOR						
31780	TAPON DE GASOLINA	39092	SENSOR						
31412	TAPON DE RADIADOR	T41232	SENSOR						
T41016	SENSOR ARBOL DE LEVAS	T43129	SENSOR HIDRAULICO						
33568	TERMOSTATO	33992	TERMOSTATOS						
4 CIL, 2.0 L	1999	K040332	A.A.	{125 D x 26.0 mm}	V-6, 3.5 L	2009	T329	BANDA ARBOL DE LEVAS	CON LLAVE 16 LBS. MOTOR J35A6 MOTOR J35A7
		K040322	ALT.				TCK329	KIT DE DISTRIBUCION	
		T184	BANDA ARBOL DE LEVAS				23391	MANGUERA INF.	
		19176	CALEF. A MOTOR				23390	MANGUERA SUP.	
		18802	CALEF. A VALVULA-1				23517	MANGUERA SUP.	
		K040353	D.H.				36112	POLEA	
		TCK184	KIT DE DISTRIBUCION				36112	POLEA	
		21871	MANGUERA INF.				T41231	POLEA DE DISTRIBUCION	
		22322	MANGUERA SUP.				K060840	SERPENTIN	
		18701	PASO				31284	TAPON DE ACEITE	
18700	PASO	31783	TAPON DE GASOLINA						
38030	POLEA	31637	TAPON DE GASOLINA						
31109	TAPON DE ACEITE	31412	TAPONES DE RADIADOR						
31832	TAPON DE GASOLINA	T41232	SENSOR						
31780	TAPON DE GASOLINA	38332	SENSOR						
31412	TAPON DE RADIADOR	39092	SENSOR						
T41016	SENSOR ARBOL DE LEVAS	T43129	SENSOR HIDRAULICO						
33568	TERMOSTATO	33992	TERMOSTATOS						
4 CIL, 2.0 L	1999	K040332	A.A.	{125 D x 26.0 mm}	V-6, 3.5 L	2008	T329	BANDA ARBOL DE LEVAS	CON LLAVE 16 LBS. MOTOR J35A6 MOTOR J35A7
		K040322	ALT.				TCK329	KIT DE DISTRIBUCION	
		T184	BANDA ARBOL DE LEVAS				23391	MANGUERA INF.	
		19176	CALEF. A MOTOR				23390	MANGUERA SUP.	
		18802	CALEF. A VALVULA-1				23517	MANGUERA SUP.	
		K040353	D.H.				36112	POLEA	
		TCK184	KIT DE DISTRIBUCION				36112	POLEA	
		21871	MANGUERA INF.				T41231	POLEA DE DISTRIBUCION	
		22322	MANGUERA SUP.				K060840	SERPENTIN	
		18701	PASO				31284	TAPON DE ACEITE	
18700	PASO	31783	TAPON DE GASOLINA						
38030	POLEA	31637	TAPON DE GASOLINA						
31109	TAPON DE ACEITE	31412	TAPONES DE RADIADOR						
31832	TAPON DE GASOLINA	T41232	SENSOR						
31780	TAPON DE GASOLINA	38332	SENSOR						
31412	TAPON DE RADIADOR	39092	SENSOR						
T41016	SENSOR ARBOL DE LEVAS	T43129	SENSOR HIDRAULICO						
33568	TERMOSTATO	33992	TERMOSTATOS						
4 CIL, 2.0 L	1999	K040332	A.A.	{125 D x 26.0 mm}	V-6, 3.5 L	2008	T329	BANDA ARBOL DE LEVAS	VERSION EXL, TOURING VERSION EX, LX MOTOR J35A6 MOTOR J35A6
		K040322	ALT.				TCK329	KIT DE DISTRIBUCION	
		T184	BANDA ARBOL DE LEVAS				23391	MANGUERA INF.	
		19176	CALEF. A MOTOR				23390	MANGUERA SUP.	
		18802	CALEF. A VALVULA-1				23517	MANGUERA SUP.	
		K040353	D.H.				36112	POLEA	
		TCK184	KIT DE DISTRIBUCION				36112	POLEA	
		21871	MANGUERA INF.				T41231	POLEA DE DISTRIBUCION	
		22322	MANGUERA SUP.				K060840	SERPENTIN	
		18701	PASO				31284	TAPON DE ACEITE	
18700	PASO	31783	TAPON DE GASOLINA						
38030	POLEA	31637	TAPON DE GASOLINA						
31109	TAPON DE ACEITE	31412	TAPONES DE RADIADOR						
31832	TAPON DE GASOLINA	T41232	SENSOR						
31780	TAPON DE GASOLINA	38332	SENSOR						
31412	TAPON DE RADIADOR	39092	SENSOR						
T41016	SENSOR ARBOL DE LEVAS	T43129	SENSOR HIDRAULICO						
33568	TERMOSTATO	33992	TERMOSTATOS						

**ODYSSEY**

**FIT**

    				    					
V-6, 3.5 L	2008	31412 T41232 38332 39092 T43129 33992	TAPONES DE RADIADOR TENSOR TENSOR TENSOR TENSOR HIDRAULICO TERMOSTATOS	16 LBS.  MOTOR J35A6 MOTOR J35A7  170°					
V-6, 3.5 L	2007	T329 23391 23390 36112 K060840 31284 31637 31412 T41232 38332 33914	BANDA ARBOL DE LEVAS MANGUERA INF. MANGUERA SUP. POLEA SERPENTIN TAPON DE ACEITE TAPON DE GASOLINA TAPON DE RADIADOR TENSOR ARBOL DE LEVAS TENSOR MICRO-V TERMOSTATO		V-6, 3.5 L	2000	K060468 K060465 T286 19749 19748 19174 K040440 K040438 22341 21586 38001 31284 31780 31412 38169 33914	POLEA DEL TENSOR TAPON DE ACEITE TAPON DE GASOLINA TAPON DE RADIADOR TENSOR MICRO-V TERMOSTATO ALT & A.A.	CON LLAVE REGULAR (16 lbs) Sin Palanca ALT. Y A.A. 170°F
V-6, 3.5 L	2006	T329 23396 23395 36112 K060840 31284 31637 31412 T41232 38332 33914	BANDA ARBOL DE LEVAS MANGUERA INF. MANGUERA SUP. POLEA SERPENTIN TAPON DE ACEITE TAPON DE GASOLINA TAPON DE RADIADOR TENSOR ARBOL DE LEVAS TENSOR MICRO-V TERMOSTATO		V-6, 3.5 L	1999	K060468 K060465 T286 19749 19748 19174 K040438 K040440 22341 21586 38001 31284 31780 31412 38169 33914	ALT & A.A. ALT. BANDA ARBOL DE LEVAS CALEF. A "T" CALEF. A MOTOR CALEF. A VALVULA-1 D.H. D.H. MANGUERA INF. MANGUERA SUP. POLEA DEL TENSOR TAPON DE ACEITE TAPON DE GASOLINA TAPON DE RADIADOR TENSOR MICRO-V TERMOSTATO	CON LLAVE REGULAR (16 lbs) Sin Palanca ALT. Y A.A. 170°F
V-6, 3.5 L	2005	T329 23396 23395 36112 K060840 31284 31637 31412 38332 33914	BANDA ARBOL DE LEVAS MANGUERA INF. MANGUERA SUP. POLEA SERPENTIN TAPON DE ACEITE TAPON DE GASOLINA TAPON DE RADIADOR TENSOR MICRO-V TERMOSTATO		V-6, 3.5 L	2005	K040438 K040440 22341 21586 38001 31284 31780 31412 38169 33914	D.H. D.H. MANGUERA INF. MANGUERA SUP. POLEA DEL TENSOR TAPON DE ACEITE TAPON DE GASOLINA TAPON DE RADIADOR TENSOR MICRO-V TERMOSTATO	CON LLAVE REGULAR (16 lbs) Sin Palanca ALT. Y A.A. 170°F
V-6, 3.5 L	2004	T286 K040438 K060458 31284 31832 31412 38322 33914	BANDA ARBOL DE LEVAS SERPENTIN SERPENTIN TAPON DE ACEITE TAPON DE GASOLINA TAPON DE RADIADOR TENSOR MICRO-V TERMOSTATO		V-6, 3.5 L	2004	T329 TCK329 T41231 K060840 31284 31783 31637 31412 T41232 39092 T43129 33992	BANDA ARBOL DE LEVAS KIT DE DISTRIBUCION POLEA DE DISTRIBUCION SERPENTIN TAPON DE ACEITE TAPON DE GASOLINA TAPON DE GASOLINA TAPONES DE RADIADOR TENSOR TENSOR TENSOR HIDRAULICO TERMOSTATOS	CON LLAVE 16 LBS. 170°
V-6, 3.5 L	2003	K060458 K040438 31109 31832 31412 38322 33914	ALT., A.A. D.H. TAPON DE ACEITE TAPON DE GASOLINA TAPON DE RADIADOR TENSOR MICRO-V TERMOSTATO		V-6, 3.5 L	2003	T329 TCK329 T41231 K060840 31284 31783 31637 31412 T41232 39092 T43129 33992	BANDA ARBOL DE LEVAS KIT DE DISTRIBUCION POLEA DE DISTRIBUCION SERPENTIN TAPON DE ACEITE TAPON DE GASOLINA TAPON DE GASOLINA TAPONES DE RADIADOR TENSOR TENSOR TENSOR HIDRAULICO TERMOSTATOS	CON LLAVE 16 LBS. 170°
V-6, 3.5 L	2002	T286 19749 19748 19174 K040438 22341 21586 38001 19750 19178 31284 31412 38322 30T 5/8"	BANDA ARBOL DE LEVAS CALEF. A "T" CALEF. A MOTOR CALEF. A VALVULA-1 D.H. MANGUERA INF. MANGUERA SUP. POLEA DEL TENSOR T A MOTOR T A MULTIPLE TAPON DE ACEITE TAPON DE RADIADOR TENSOR MICRO-V VALVULA A "T"		V-6, 3.5 L	2002	T329 TCK329 T41231 K060840 31284 31783 31637 31412 T41232 39092 T43129 33992	BANDA ARBOL DE LEVAS KIT DE DISTRIBUCION POLEA DE DISTRIBUCION SERPENTIN TAPON DE ACEITE TAPON DE GASOLINA TAPON DE GASOLINA TAPONES DE RADIADOR TENSOR TENSOR TENSOR HIDRAULICO TERMOSTATOS	CON LLAVE 16 LBS. 170°
V-6, 3.5 L	2001	K060468 T286 19749 19748 19174 K040438 22341 21586	ALT & A.A. BANDA ARBOL DE LEVAS CALEF. A "T" CALEF. A MOTOR CALEF. A VALVULA-1 D.H. MANGUERA INF. MANGUERA SUP.		V-6, 3.5 L	2001	T329 TCK329 23319 23320 36112 T41231 36112 K060840 31284 31783	BANDA ARBOL DE LEVAS KIT DE DISTRIBUCION MANGUERA INF. MANGUERA SUP. POLEA POLEA DE DISTRIBUCION POLEA DEL TENSOR SERPENTIN TAPON DE ACEITE TAPON DE GASOLINA	CON LLAVE

**PILOT**

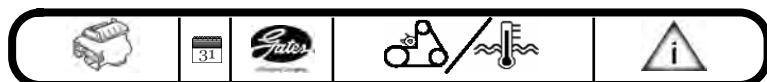
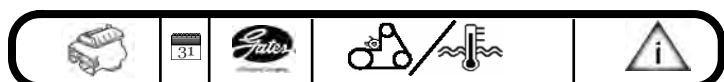

V-6, 3.5 L	2008	31637 31412 T41232 38332 T43129 33992	TAPON DE GASOLINA TAPONES DE RADIADOR TENSOR TENSOR TENSOR HIDRAULICO TERMOSTATOS	16 LBS.     170°	V-6, 3.5 L	2008	38332 T43129 33992 T329 TCK329 36112 T41231 36112 K060840 31284 31783 31637 31412 T41232 38332 T43129 33992	TENSOR TENSOR HIDRAULICO TERMOSTATOS BANDA ARBOL DE LEVAS KIT DE DISTRIBUCION POLEA POLEA DE DISTRIBUCION POLEA DEL TENSOR SERPENTIN TAPON DE ACEITE TAPON DE GASOLINA TAPON DE RADIADOR TAPONES DE RADIADOR TENSOR TENSOR TENSOR HIDRAULICO TERMOSTATOS	170°                 170°
V-6, 3.5 L	2007	T329 23319 23320 36112 K060840 31109 31832 31412 T41232 38332 33914	BANDA ARBOL DE LEVAS MANGUERA INF. MANGUERA SUP. POLEA SERPENTIN TAPON DE ACEITE TAPON DE GASOLINA TAPON DE RADIADOR TENSOR ARBOL DE LEVAS TENSOR MICRO-V TERMOSTATO	SIN LLAVE REGULAR (16 lbs) Sin Palanca  170°F	V-6, 3.5 L	2007	T329 23318 23317 36112 K060840 T41232 38332 T329 23318 23317 36112 K060840 T41232 38332	BANDA ARBOL DE LEVAS MANGUERA INF. MANGUERA SUP. POLEA SERPENTIN TENSOR ARBOL DE LEVAS TENSOR MICRO-V BANDA ARBOL DE LEVAS MANGUERA INF. MANGUERA SUP. POLEA SERPENTIN TAPON DE ACEITE TAPON DE GASOLINA TAPON DE RADIADOR TENSOR ARBOL DE LEVAS TENSOR MICRO-V TERMOSTATO	CON LLAVE                 170°
V-6, 3.5 L	2006	T329 23319 23320 36112 K060840 31109 31832 31412 T41232 38332 33914	BANDA ARBOL DE LEVAS MANGUERA INF. MANGUERA SUP. POLEA SERPENTIN TAPON DE ACEITE TAPON DE GASOLINA TAPON DE RADIADOR TENSOR ARBOL DE LEVAS TENSOR MICRO-V TERMOSTATO	SIN LLAVE REGULAR (16 lbs) Sin Palanca  170°F	V-6, 3.5 L	2006	T329 23318 23317 36112 K060840 T41232 38332 T329 23318 23317 36112 K060840 T41232 38332	BANDA ARBOL DE LEVAS MANGUERA INF. MANGUERA SUP. POLEA SERPENTIN TENSOR ARBOL DE LEVAS TENSOR MICRO-V BANDA ARBOL DE LEVAS MANGUERA INF. MANGUERA SUP. POLEA SERPENTIN TAPON DE ACEITE TAPON DE GASOLINA TAPON DE RADIADOR TENSOR ARBOL DE LEVAS TENSOR MICRO-V TERMOSTATO	CON LLAVE                 170°F
V-6, 3.5 L	2005	T329 36112 K060840 31109 31832 31412 38332 33914	BANDA ARBOL DE LEVAS POLEA SERPENTIN TAPON DE ACEITE TAPON DE GASOLINA TAPON DE RADIADOR TENSOR MICRO-V TERMOSTATO	SIN LLAVE REGULAR (16 lbs) Sin Palanca  170°F	V-6, 3.5 L	2005	T329 36112 K060840 31109 31832 31412 38332 33914	BANDA ARBOL DE LEVAS POLEA SERPENTIN TAPON DE ACEITE TAPON DE GASOLINA TAPON DE RADIADOR TENSOR MICRO-V TERMOSTATO	SIN LLAVE REGULAR (16 lbs) Sin Palanca  170°F
V-6, 3.5 L	2004	T286 K060468 K040438 31284 31832 31412 38327 33914	BANDA ARBOL DE LEVAS SERPENTIN SERPENTIN TAPON DE ACEITE TAPON DE GASOLINA TAPON DE RADIADOR TENSOR MICRO-V TERMOSTATO	ALT. & A.A. D.H.  SIN LLAVE REGULAR (16 lbs) Sin Palanca ALT. Y A.A. 170°F	V-6, 3.5 L	2004	T286 K060468 K040438 31284 31832 31412 38327 33914	BANDA ARBOL DE LEVAS SERPENTIN SERPENTIN TAPON DE ACEITE TAPON DE GASOLINA TAPON DE RADIADOR TENSOR MICRO-V TERMOSTATO	ALT. & A.A. D.H.  SIN LLAVE REGULAR (16 lbs) Sin Palanca ALT. Y A.A. 170°F
V-6, 3.5 L	2003	K060468 T286 K040438 31109 31284 31832 31412 38327 33914	ALT., A.A. BANDA ARBOL DE LEVAS D.H. TAPON DE ACEITE TAPON DE ACEITE TAPON DE GASOLINA TAPON DE RADIADOR TENSOR MICRO-V TERMOSTATO	{197 D x 26.0 mm}   SIN LLAVE REGULAR (16 lbs) Sin Palanca ALT. Y A.A. 170°F	V-6, 3.5 L	2003	K060468 T286 K040438 31109 31284 31832 31412 38327 33914	ALT., A.A. BANDA ARBOL DE LEVAS D.H. TAPON DE ACEITE TAPON DE ACEITE TAPON DE GASOLINA TAPON DE RADIADOR TENSOR MICRO-V TERMOSTATO	SIN LLAVE REGULAR (16 lbs) Sin Palanca ALT. Y A.A. 170°F

# HUMMER

## H1

V-8, 6.6 L	2007	21488 20685 38008 K061187 31676 31528 38172 20685 21488 38008 K061187 31676 31528 38172	MANG. INF. MANG. INF. POLEA SERPENTIN TAPON DE GASOLINA TAPON DE RADIADOR TENSOR MICRO-V MANG. INF. MANG. INF. POLEA SERPENTIN TAPON DE GASOLINA TAPON DE RADIADOR TENSOR MICRO-V	RAD A TANQUE TUBO A B.A.    SIN LLAVE REGULAR (16 lbs) Sin Palanca  TUBO A B.A. RAD A TANQUE   SIN LLAVE REGULAR (16 lbs) Sin Palanca
V-8, 6.6 L	2006	21488 38008 K061187 31676 31528 38172	MANG. INF. MANG. INF. POLEA SERPENTIN TAPON DE GASOLINA TAPON DE RADIADOR TENSOR MICRO-V	TUBO A B.A. RAD A TANQUE   SIN LLAVE REGULAR (16 lbs) Sin Palanca

## H2

V-8, 6.2 L	2010	K040355SF 91030 23439 23438 36299 38009 K060935 31103 31844 31843 31532 39083 33963 K040355SF 91030 23439	A.A. STRECH FIT HERRAMIENTA INST. STRECH F MANGUERA INF. MANGUERA SUP. POLEA POLEA DEL TENSOR SERPENTIN TAPON DE ACEITE TAPON DE GASOLINA TAPON DE GASOLINA TAPONES DE RADIADOR TENSOR TERMOSTATOS A.A. STRECH FIT HERRAMIENTA INST. STRECH F MANGUERA INF.	CON LLAVE                15 LBS.  186°
V-8, 6.2 L	2009	K040355SF 91030 23439	A.A. STRECH FIT HERRAMIENTA INST. STRECH F MANGUERA INF.	CON LLAVE  15 LBS.  186°

## RIDGELINE

V-6, 3.5 L	2010	T329 TCK329 36112 T41231 36112 K060840 38332 T41232 T43129	BANDA ARBOL DE LEVAS KIT DE DISTRIBUCION POLEA POLEA DE DISTRIBUCION POLEA DEL TENSOR SERPENTIN TENSOR TENSOR TENSOR HIDRAULICO	CON LLAVE       16 LBS.
V-6, 3.5 L	2009	T329 TCK329 36112 T41231 36112 K060840 31284 31783 31637 31412 T41232	BANDA ARBOL DE LEVAS KIT DE DISTRIBUCION POLEA POLEA DE DISTRIBUCION POLEA DEL TENSOR SERPENTIN TAPON DE ACEITE TAPON DE GASOLINA TAPON DE GASOLINA TAPONES DE RADIADOR TENSOR	CON LLAVE       16 LBS.





V-8, 6.2 L	2009	23438	MANGUERA SUP.		
		36299	POLEA		
		38009	POLEA DEL TENSOR		
		K060935	SERPENTIN		
		31103	TAPON DE ACEITE		
		31844	TAPON DE GASOLINA	CON LLAVE	
		31843	TAPON DE GASOLINA		5 CIL, 3.7 L
		31532	TAPONES DE RADIADOR	15 LBS.	
		39083	TENSOR		
		33963	TERMOSTATOS	186°	
V-8, 6.2 L	2008	23439	MANGUERA INF.		
		23438	MANGUERA SUP.		
		36299	POLEA		
		36169	POLEA DEL TENSOR	A.A.	
		38009	POLEA DEL TENSOR		
		K040378	SERPENTIN	A.A.	
		K060935	SERPENTIN		5 CIL, 3.5 L
		31103	TAPON DE ACEITE		
		31844	TAPON DE GASOLINA	CON LLAVE	
		31843	TAPON DE GASOLINA		
V-8, 6.0 L	2007	31532	TAPONES DE RADIADOR	15 LBS.	
		38158	TENSOR		
		38159	TENSOR	A.A.	
		33963	TERMOSTATOS	186°	
		18914	MANG. DE CALEFACCION		5 CIL, 3.5 L
		22750	MANG. INF.		
		22436	MANG. SUP.		
		38009	POLEA	SERPENTIN	
		38001	POLEA	SERPENTIN	
		K060930	SERPENTIN		
V-8, 6.0 L	2006	K040378	SERPENTIN	A.A.	
		31103	TAPON DE ACEITE		
		31843	TAPON DE GASOLINA	SIN LLAVE REGULAR	
		31532	TAPON DE RADIADOR	(15 lbs) Sin palanca	
		38159	TENSOR MICRO-V	A.A.	
		38158	TENSOR MICRO-V	SERPENTIN	
		33963	TERMOSTATO	186°F	
		18914	MANG. DE CALEFACCION		
		22750	MANG. INF.		4 CIL, 1.1 L
		22436	MANG. SUP.		
V-8, 6.0 L	2005	38009	POLEA		
		38001	POLEA LOCA		
		K060930	SERPENTIN		
		K040378	SERPENTIN	A.A.	
		31103	TAPON DE ACEITE		
		31843	TAPON DE GASOLINA	SIN LLAVE REGULAR	
		31532	TAPON DE RADIADOR	(15 lbs) Sin palanca	
		38159	TENSOR MICRO-V	A.A.	
		38158	TENSOR MICRO-V	SERPENTIN	
		33963	TERMOSTATO	186°F	

K060915	2008	31103	SERPENTIN		
		31844	TAPON DE ACEITE		
		31843	TAPON DE GASOLINA	CON LLAVE	
		31532	TAPONES DE RADIADOR	15 LBS.	
		38178	TENSOR		
		22917	MANGUERA INF.		
		22129	MANGUERA SUP.		
		36301	POLEA		
		36101	POLEA DEL TENSOR		
		K060915	SERPENTIN		
K060915	2007	31103	TAPON DE ACEITE		
		31844	TAPON DE GASOLINA	CON LLAVE	
		31843	TAPON DE GASOLINA		
		31532	TAPONES DE RADIADOR	15 LBS.	
		38178	TENSOR		
		22917	MANG. INF.		
		22129	MANG. SUP.		
		36101	POLEA		
		K060915	SERPENTIN		
		31103	TAPON DE ACEITE		
K060915	2006	31843	TAPON DE GASOLINA	SIN LLAVE REGULAR	
		31532	TAPON DE RADIADOR	(15 lbs) Sin palanca	
		38178	TENSOR MICRO-V		
		22917	MANGUERA INF.		
		22129	MANGUERA SUP.		
		36101	POLEA		
		K060915	SERPENTIN		
		31103	TAPON DE ACEITE		
		31843	TAPON DE GASOLINA	SIN LLAVE REGULAR	
		31532	TAPON DE RADIADOR	(15 lbs) Sin palanca	











**HYUNDAI**





**ATOS**





4 CIL, 1.1 L	2010	T1013	BANDA ARBOL DE LEVAS		101 D X 20MM
		TCK1013	KIT DE DISTRIBUCION		
		CH-110092	MANGUERA INF.		
		CH-110081	MANGUERA SUP.		
		K040295	SERPENTIN		D.H.
		K040267	SERPENTIN		A.A.
		K040300	SERPENTIN		ALT.
		31748	TAPON DE GASOLINA		
		31778	TAPON DE GASOLINA	CON LLAVE	
		31333	TAPONES DE RADIADOR	13 LBS.	
4 CIL, 1.1 L	2009	T41241	TENSOR		
		T1013	BANDA ARBOL DE LEVAS		101 D X 20MM
		TCK1013	KIT DE DISTRIBUCION		
		CH-110092	MANGUERA INF.		
		CH-110081	MANGUERA SUP.		
		K040300	SERPENTIN		ALT.
		K040295	SERPENTIN		D.H.
		K040267	SERPENTIN		A.A.
		31748	TAPON DE GASOLINA		
		31778	TAPON DE GASOLINA	CON LLAVE	
4 CIL, 1.1 L	2008	31333	TAPONES DE RADIADOR	13 LBS.	
		T41241	TENSOR		
		K040300	ALT.		
		T1013	BANDA ARBOL DE LEVAS		{101 D x 20 mm}
		K040295	D.H.		
		TCK1013	KIT DE DISTRIBUCION		
		CH-110092	MANGUERA INF.		
		CH-110081	MANGUERA SUP.		
		K040267	SERPENTIN		A.A.
		31778	TAPON DE GASOLINA	CON LLAVE	
4 CIL, 1.1 L	2007	31748	TAPON DE GASOLINA		
		T41241	TENSOR ARBOL DE LEVAS		
		T41241	TENSOR ARBOL DE LEVAS		
		K040300	ALT.		
		T1013	BANDA ARBOL DE LEVAS		{101 D x 20 mm}
		K040295	D.H.		

**H3**

5 CIL, 3.7 L	2010	22917	MANGUERA INF.		4 CIL, 1.1 L
		22129	MANGUERA SUP.		
		36301	POLEA		
		36101	POLEA DEL TENSOR		
		K060915	SERPENTIN		
		31103	TAPON DE ACEITE		
		31844	TAPON DE GASOLINA	CON LLAVE	
		31843	TAPON DE GASOLINA		
		31532	TAPONES DE RADIADOR	15 LBS.	
		38178	TENSOR		
5 CIL, 3.7 L	2009	22917	MANGUERA INF.		
		22129	MANGUERA SUP.		4 CIL, 1.1 L
		36301	POLEA		
		36101	POLEA DEL TENSOR		

    				    					
4 CIL, 1.1 L	2007	TCK1013 CH-110092 CH-110081 K040267 31778 31748 T41241	KIT DE DISTRIBUCION MANGUERA INF. MANGUERA SUP. SERPENTIN TAPON DE GASOLINA TAPON DE GASOLINA TENSOR ARBOL DE LEVAS	A.A. CON LLAVE	CH-110092 CH-110081 K040267 31615 31533 31333 T41241	MANGUERA INF. MANGUERA SUP. SERPENTIN TAPON DE GASOLINA TAPON DE RADIADOR TAPON DE RADIADOR TENSOR ARBOL DE LEVAS	C/AA Y S/AA C/DH Y S/DH C/AA Y S/AA C/DH Y S/DH A.A. SIN LLAVE C/CONT. DE EMIS (13 lbs) Con palanca (13 lbs) Sin palanca		
4 CIL, 1.1 L	2006	K040300 T1013 K040295 TCK1013 CH-110092 CH-110081 K040267 31748 31778 T41241	ALT. BANDA ARBOL DE LEVAS D.H. KIT DE DISTRIBUCION MANGUERA INF. MANGUERA SUP. SERPENTIN TAPON DE GASOLINA TAPON DE GASOLINA TENSOR ARBOL DE LEVAS	{101 D x 20 mm}	<b>ATTITUDE</b>				
4 CIL, 1.1 L	2005	K040300 T1013 K040295 TCK1013 CH-110092 CH-110081 K040267 31748 31778 T41241	ALT. BANDA ARBOL DE LEVAS D.H. KIT DE DISTRIBUCION MANGUERA INF. MANGUERA SUP. SERPENTIN TAPON DE GASOLINA TAPON DE GASOLINA TENSOR ARBOL DE LEVAS	{101 D x 20 mm}	4 CIL, 1.4 L	2010	T282 23230 22827 T42016 36086 K040319 K040332 8265GS 31109 31783 31846 31845 T41037 33938	BANDA ARBOL DE LEVAS MANGUERA INF. MANGUERA SUP. POLEA DE DISTRIBUCION POLEA DEL TENSOR SERPENTIN SERPENTIN SERPENTIN TAPON DE ACEITE TAPON DE GASOLINA TAPON DE GASOLINA TAPONES DE RADIADOR TENSOR TERMOSTATOS	105 D X 22 MM A.A. ALT. CON LLAVE 16 LBS. 180°
4 CIL, 1.0 L	2004	K040300 T1013 K040295 TCK1013 CH-110092 CH-110081 K040267 31615 31533 31333 T41241	ALT. BANDA ARBOL DE LEVAS D.H. KIT DE DISTRIBUCION MANGUERA INF. MANGUERA SUP. SERPENTIN TAPON DE GASOLINA TAPON DE GASOLINA TENSOR ARBOL DE LEVAS	C/AA Y S/AA C/DH Y S/DH C/AA Y S/AA C/DH Y S/DH C/AA Y S/AA C/DH Y S/DH A.A. SIN LLAVE C/CONT. DE EMIS (13 lbs) Con palanca (13 lbs) Sin palanca	4 CIL, 1.6 L	2010	T282 23230 22827 T42016 36086 K040319 8265GS K040332 31109 31846 31783 31845 T41037 33938	BANDA ARBOL DE LEVAS MANGUERA INF. MANGUERA SUP. POLEA DE DISTRIBUCION POLEA DEL TENSOR SERPENTIN SERPENTIN SERPENTIN TAPON DE ACEITE TAPON DE GASOLINA TAPON DE GASOLINA TAPONES DE RADIADOR TENSOR TERMOSTATOS	105 D X 22 MM A.A. ALT. CON LLAVE 16 LBS. 180°
4 CIL, 1.0 L	2003	K040300 T1013 K040295 TCK1013 CH-110092 CH-110081 K040267 31615 31533 31333 T41241	ALT. BANDA ARBOL DE LEVAS D.H. KIT DE DISTRIBUCION MANGUERA INF. MANGUERA SUP. SERPENTIN TAPON DE GASOLINA TAPON DE RADIADOR TAPON DE RADIADOR TENSOR ARBOL DE LEVAS	C/AA Y S/AA C/DH Y S/DH C/AA Y S/AA C/DH Y S/DH C/AA Y S/AA C/DH Y S/DH A.A. SIN LLAVE C/CONT. DE EMIS (13 lbs) Con palanca (13 lbs) Sin palanca	4 CIL, 1.4 L	2009	T282 23230 22827 T42016 36086 8265GS K040319 K040332 31109 31846 31783 31845 T41037 33938	BANDA ARBOL DE LEVAS MANGUERA INF. MANGUERA SUP. POLEA DE DISTRIBUCION POLEA DEL TENSOR SERPENTIN SERPENTIN SERPENTIN TAPON DE ACEITE TAPON DE GASOLINA TAPON DE GASOLINA TAPONES DE RADIADOR TENSOR TERMOSTATOS	105 D X 22 MM A.A. ALT. CON LLAVE 16 LBS. 180°
4 CIL, 1.0 L	2002	K040300 T1013 K040295 TCK1013 CH-110092 CH-110081 K040267 31615 31333 31533 T41241	ALT. BANDA ARBOL DE LEVAS D.H. KIT DE DISTRIBUCION MANGUERA INF. MANGUERA SUP. SERPENTIN TAPON DE GASOLINA TAPON DE RADIADOR TAPON DE RADIADOR TENSOR ARBOL DE LEVAS	C/AA Y S/AA C/DH Y S/DH C/AA Y S/AA C/DH Y S/DH C/AA Y S/AA C/DH Y S/DH A.A. SIN LLAVE C/CONT. DE EMIS (13 lbs) Sin palanca (13 lbs) Con palanca	4 CIL, 1.6 L	2009	T282 23230 22827 T42016 36086 8265GS K040332 K040319 31109 31846 31783 31845 T41037 33938	BANDA ARBOL DE LEVAS MANGUERA INF. MANGUERA SUP. POLEA DE DISTRIBUCION POLEA DEL TENSOR SERPENTIN SERPENTIN SERPENTIN TAPON DE ACEITE TAPON DE GASOLINA TAPON DE GASOLINA TAPONES DE RADIADOR TENSOR TERMOSTATOS	105 D X 22 MM A.A. ALT. CON LLAVE 16 LBS. 180°
4 CIL, 1.0 L	2001	K040300 T1013 K040295 TCK1013 CH-110092 CH-110081 K040267 31615 31333 31533 T41241	ALT. BANDA ARBOL DE LEVAS D.H. KIT DE DISTRIBUCION MANGUERA INF. MANGUERA SUP. SERPENTIN TAPON DE GASOLINA TAPON DE RADIADOR TAPON DE RADIADOR TENSOR ARBOL DE LEVAS	C/AA Y S/AA C/DH Y S/DH C/AA Y S/AA C/DH Y S/DH C/AA Y S/AA C/DH Y S/DH A.A. SIN LLAVE C/CONT. DE EMIS (13 lbs) Sin palanca (13 lbs) Con palanca	4 CIL, 1.4 L	2008	T282 23230 22827 T42016 36086 8265GS K040332 K040319 31109	BANDA ARBOL DE LEVAS MANGUERA INF. MANGUERA SUP. POLEA DE DISTRIBUCION POLEA DEL TENSOR SERPENTIN SERPENTIN SERPENTIN TAPON DE ACEITE	105 D X 22 MM A.A. ALT. CON LLAVE 16 LBS. 180°
4 CIL, 1.0 L	2000	K040300 T1013 K040295 TCK1013	ALT. BANDA ARBOL DE LEVAS D.H. KIT DE DISTRIBUCION	C/AA Y S/AA C/DH Y S/DH					

				
4 CIL, 1,4 L	2008	31846 31783 31845 T41037 33938 T282 23230 22827 T42016 36086 K040319 K040332 8265GS 31109 31783 31846 31845 T41037 33938	TAPON DE GASOLINA TAPON DE GASOLINA TAPONES DE RADIADOR TENSOR TERMOSTATOS BANDA ARBOL DE LEVAS MANGUERA INF. MANGUERA SUP. POLEA DE DISTRIBUCION POLEA DEL TENSOR SERPENTIN SERPENTIN SERPENTIN TAPON DE ACEITE TAPON DE GASOLINA TAPON DE GASOLINA TAPONES DE RADIADOR TENSOR TERMOSTATOS	CON LLAVE 16 LBS.  180° 105 D X 22 MM      A.A. ALT.  CON LLAVE 16 LBS.  180°
4 CIL, 1,6 L	2008	K040319 K040332 T282 8265GS 23230 22827 T42016 36086 T41037	A.A. ALT. BANDA ARBOL DE LEVAS D.H. MANGUERA INF. MANGUERA SUP. POLEA DE DISTRIBUCION POLEA DEL TENSOR TENSOR ARBOL DE LEVAS	A.A.
4 CIL, 1,6 L	2007	K040319 K040332 T282 8265GS 23230 22827 T42016 36086 T41037	A.A. ALT. BANDA ARBOL DE LEVAS D.H. MANGUERA INF. MANGUERA SUP. POLEA DE DISTRIBUCION POLEA DEL TENSOR TENSOR ARBOL DE LEVAS	{105 D x 22.0 mm}
4 CIL, 1,6 L	2006	K040319 K040332 T282 8265GS 23230 22827 T42016 36086 T41037	A.A. ALT. BANDA ARBOL DE LEVAS D.H. MANGUERA INF. MANGUERA SUP. POLEA DE DISTRIBUCION POLEA DEL TENSOR TENSOR ARBOL DE LEVAS	A.A.  {105 D x 22.0 mm}

				
4 CIL, 2,4 L	2005	CH-119412 CH-119411 6469MC K040385 T159 T124 6470MC CH-119402 CH-119401 T41044 6469MC K040385 T159 T124 6470MC CH-119402 CH-119401 T41044	MANGUERA INF. MANGUERA SUP. A.A. ALT. BALANCIN BANDA ARBOL DE LEVAS D.H. MANGUERA INF. MANGUERA SUP. TENSOR ARBOL DE LEVAS A.A. ALT. BALANCIN BANDA ARBOL DE LEVAS D.H. MANGUERA INF. MANGUERA SUP. TENSOR ARBOL DE LEVAS	55 D X 12.7 mm {123 D x 19.0 mm}
4 CIL, 2,4 L	2004	6469MC K040385 T159 T124 6470MC CH-119402 CH-119401 T41044	A.A. ALT. BALANCIN BANDA ARBOL DE LEVAS D.H. MANGUERA INF. MANGUERA SUP. TENSOR ARBOL DE LEVAS	55 D X 12.7 mm 3 D x 19.0 mm}
4 CIL, 2,4 L	2003	6469MC T159 T124 6470MC CH-119402 CH-119401 T41044	A.A. BALANCIN BANDA ARBOL DE LEVAS D.H. MANGUERA INF. MANGUERA SUP. TENSOR ARBOL DE LEVAS	55 D X 12.7 mm 3 D x 19.0 mm}

**H100 VAN/WAGON**

4 CIL, 2,5 L DIESEL	2010	T724 T1096 K040370 K040420 K040415 T42129	BALANCIN BANDA ARBOL DE LEVAS SERPENTIN SERPENTIN SERPENTIN TENSOR	99 D X 19 mm 163 D X 25.4 mm A.A. ALT. D.H.
4 CIL, 2,5 L DIESEL	2009	T724 T1096 K040415 K040370 K040420 T42129	BALANCIN BANDA ARBOL DE LEVAS SERPENTIN SERPENTIN SERPENTIN TENSOR	99 D X 19 mm 163 D X 25.4 mm D.H. A.A. ALT.

**H100**

4 CIL, 2,5 L DIESEL	2010	T724 T1096 CH-119412 CH-119411 K040415 K040420 K040370 T42129	BALANCIN BANDA ARBOL DE LEVAS MANGUERA INF. MANGUERA SUP. SERPENTIN SERPENTIN SERPENTIN TENSOR	99 D X 19 mm 163 D X 25.4 mm D.H. ALT. A.A.
4 CIL, 2,5 L DIESEL	2009	T724 T1096 CH-119412 CH-119411 K040415 K040370 K040420 T42129	BALANCIN BANDA ARBOL DE LEVAS MANGUERA INF. MANGUERA SUP. SERPENTIN SERPENTIN SERPENTIN TENSOR	99 D X 19 mm 163 D X 25.4 mm D.H. A.A. ALT.
4 CIL, 2,5 L DIESEL	2008	K040370 K040420 T724 T1096 K040415 CH-119412 CH-119411	A.A. ALT. BALANCIN BANDA ARBOL DE LEVAS D.H. MANGUERA INF. MANGUERA SUP.	99 D X 19 mm
4 CIL, 2,5 L DIESEL	2007	K040370 K040420 T724 T1096 K040415 CH-119412 CH-119411	A.A. ALT. BALANCIN BANDA ARBOL DE LEVAS D.H. MANGUERA INF. MANGUERA SUP.	99 D X 19 mm
4 CIL, 2,5 L DIESEL	2006	K040370 K040420 T724 T1096 K040415	A.A. ALT. BALANCIN BANDA ARBOL DE LEVAS D.H.	99 D X 19 mm

**VERNA**

4 CIL, 1,5 L	2006	K040335 K050355 T324 K040233 22214 21964 T41037	A.A. ALT. BANDA ARBOL DE LEVAS D.H. MANGUERA INF. MANGUERA SUP. TENSOR ARBOL DE LEVAS	{110 D x 22 mm}
4 CIL, 1,6 L	2006	K040319 K040332 T282 8265GS 22026 22215 T41037	A.A. ALT. BANDA ARBOL DE LEVAS D.H. MANGUERA INF. MANGUERA SUP. TENSOR ARBOL DE LEVAS	{105 D x 22.0 mm}
4 CIL, 1,5 L	2005	K040335 K050355 T324 K040233 22214 21964 T41037	A.A. ALT. BANDA ARBOL DE LEVAS D.H. MANGUERA INF. MANGUERA SUP. TENSOR ARBOL DE LEVAS	{110 D x 22 mm}
4 CIL, 1,6 L	2005	K040319 K040332 T282 8265GS 22026 22215 T41037	A.A. ALT. BANDA ARBOL DE LEVAS D.H. MANGUERA INF. MANGUERA SUP. TENSOR ARBOL DE LEVAS	{105 D x 22.0 mm}
4 CIL, 1,5 L	2004	K040335 K050355 T324 K040223 22214	A.A. ALT. BANDA ARBOL DE LEVAS D.H. MANGUERA INF.	{110 D x 22 mm}



4 CIL, 1.5 L | 2004 | 21964 T41037 | MANGUERA SUP. TENSOR ARBOL DE LEVAS



31115 31838 33878 | 2001 | K060433 K040305 K040399 K060295 K030365 22453 22073 31115 31832 31336 | TAPON DE ACEITE TAPON DE GASOLINA TERMOSTATO ALT. D.H. A.A. ALT. D.H. INF. - RADIADOR A TUBO SUP. - RADIADOR A T1 TAPON DE ACEITE TAPON DE GASOLINA TAPON DE RADIADOR

**INFINITI**

**INFINITI I30**

V-6, 3.0 L	2001	K060435 K060427 K040305 92037 22184 22183 31115 31832 31533 31333 33912 22519	ALT & A.A. ALT. D.H. EDH MANGUERA INF. MANGUERA SUP. TAPON DE ACEITE TAPON DE GASOLINA TAPON DE RADIADOR TAPON DE RADIADOR TERMOSTATO TERMOSTATO A MOTOR	C/AA C/AA PRESION	
V-6, 3.0 L	2000	K060435 K060427 K040305 80101 28474 22184 22183 31115 31748 31533 31333 33912 22519	ALT & A.A. ALT. D.H. EDH MANGUERA DE PASO MANGUERA INF. MANGUERA SUP. TAPON DE ACEITE TAPON DE GASOLINA TAPON DE RADIADOR TAPON DE RADIADOR TERMOSTATO TERMOSTATO A MOTOR	C/AA C/AA PRESION	V-8, 4.1 L
V-6, 3.0 L	1999	K060431 K060427 K040305 80101 28474 22184 22183 31115 31748 31533 31333 33912	ALT & A.A. ALT. D.H. EDH MANGUERA DE PASO MANGUERA INF. MANGUERA SUP. TAPON DE ACEITE TAPON DE GASOLINA TAPON DE RADIADOR TAPON DE RADIADOR TERMOSTATO	C/AA C/AA PRESION	V-8, 4.1 L
V-6, 3.0 L	1998	K060427 K040305 80101 28474 22184 22183 31115 31748 31533 31333 33912	ALT. D.H. EDH MANGUERA DE PASO MANGUERA INF. MANGUERA SUP. TAPON DE ACEITE TAPON DE GASOLINA TAPON DE RADIADOR TAPON DE RADIADOR TERMOSTATO	C/AA C/AA PRESION	V-8, 4.5 L
V-6, 3.0 L	1997	K060427 K040305 80101 31115 31748 31333 31533 33912	ALT. D.H. EDH TAPON DE ACEITE TAPON DE GASOLINA TAPON DE RADIADOR TAPON DE RADIADOR TERMOSTATO	C/AA C/AA PRESION	V-8, 4.5 L

**INFINITI Q45**

V-8, 4.5 L	2003	K040372 31115 31838 31333 31533	SERPENTIN TAPON DE ACEITE TAPON DE GASOLINA TAPON DE RADIADOR TAPON DE RADIADOR	D.H. SIN LLAVE REGULAR (13 lbs) Sin palanca (13 lbs) Con palanca	V-6, 3.0 L
V-8, 4.5 L	2002	K060772 K040372	ALT., A.A. D.H.		V-8, 4.0 L











**Q45**

V-8, 4.5 L	2003	K040372 31115 31838 31333 31533	SERPENTIN TAPON DE ACEITE TAPON DE GASOLINA TAPON DE RADIADOR TAPON DE RADIADOR	D.H. SIN LLAVE REGULAR (13 lbs) Sin palanca (13 lbs) Con palanca	V-8, 4.5 L
V-8, 4.5 L	2002	31115 31838 33878	TAPON DE ACEITE TAPON DE GASOLINA TERMOSTATO	SIN LLAVE REGULAR 180°F	











**JAGUAR**

**S-TYPE**

V-6, 3.0 L	2005	22839 22509 22510 K061080	MANG. INF. MANG. INF. MANG. SUP. SERPENTIN	C/ENFRIADOR DE ACEITE S/ENFRIADOR DE ACEITE	V-6, 3.0 L
V-8, 4.0 L	2005	19807 19806 19030 28475 18787 19285 22562 19754 38001 K060938	MANG. A TUBO-1 A TERMOSTA MANG. B.A. MANG. CALEF. A TUBO DE CALI MANG. INF. MANG. SUP. MANG. SUP. MANG. SUP. MANG. VALV. A CALEF. A B.A. POLEA LOCA SERPENTIN	AUX. A TUBO-1 CALEFACTOR A TUBO DE CA CALEFACTOR A TUBO DE CA VALVULA DE CALEFACTOR A CORTAR A MEDIDA	V-8, 4.0 L
V-6, 3.0 L	2004	22509 22839 22510 K061080	MANG. INF. MANG. INF. MANG. SUP. SERPENTIN	S/ENFRIADOR DE ACEITE C/ENFRIADOR DE ACEITE	V-6, 3.0 L
V-8, 4.0 L	2004	19807 19806	MANG. A TUBO-1 A TERMOSTA MANG. B.A.	AUX. A TUBO-1	V-8, 4.0 L

    				    			
V-8, 4.0 L	2004	19030 MANG. CALEF. A TUBO DE CALI 28475 MANG. INF. 19285 MANG. SUP. 18787 MANG. SUP. 22562 MANG. SUP. 19754 MANG. VALV. A CALEF. A B.A. 38001 POLEA LOCA K060938 SERPENTIN	CALEFACTOR A TUBO DE CA VALVULA DE CALEFACTOR A CALEFACTOR A TUBO DE CA			31836 TAPON DE GASOLINA 31838 TAPON DE GASOLINA 31523 TAPON DE RADIADOR 31516 TAPON DE RADIADOR 33509 TERMOSTATO 19039 CALEF. A MOTOR 19038 CALEF. A TUBO 80290 EDH 21615 MANGUERA INF. 21821 MANGUERA SUP. 38019 POLEA 38042 POLEA 38020 POLEA LOCA K060950 SERPENTIN K060895 SERPENTIN 31118 TAPON DE ACEITE 31734 TAPON DE GASOLINA 31615 TAPON DE GASOLINA 31836 TAPON DE GASOLINA 31838 TAPON DE GASOLINA 31516 TAPON DE RADIADOR 31523 TAPON DE RADIADOR 33009 TERMOSTATO 33509 TERMOSTATO 19039 CALEF. A TUBO-1 19038 CALEF. A TUBO-2 80290 EDH 21615 MANGUERA INF. 21821 MANGUERA SUP. 38043 POLEA 38042 POLEA 38019 POLEA 38020 POLEA LOCA 38043 POLEA LOCA K060950 SERPENTIN K060910 SERPENTIN K060790 SERPENTIN 31118 TAPON DE ACEITE 31734 TAPON DE GASOLINA 31615 TAPON DE GASOLINA 31778 TAPON DE GASOLINA 31836 TAPON DE GASOLINA 31838 TAPON DE GASOLINA 31516 TAPON DE RADIADOR 31523 TAPON DE RADIADOR 33009 TERMOSTATO 360970(718; EDH 21615 MANGUERA INF. 21087 MANGUERA SUP. 38042 POLEA 38043 POLEA K060775 SERPENTIN K060790 SERPENTIN K060910 SERPENTIN 31118 TAPON DE ACEITE 31748 TAPON DE GASOLINA 31734 TAPON DE GASOLINA 31615 TAPON DE GASOLINA 31778 TAPON DE GASOLINA 31838 TAPON DE GASOLINA 31836 TAPON DE GASOLINA 31523 TAPON DE RADIADOR 33509 TERMOSTATO 80290 EDH 20559 MANGUERA INF. 15177160 MANGUERA INF. FLEXIBLE 21087 MANGUERA SUP. 1215T195 MANGUERA SUP. FLEXIBLE 38043 POLEA 38019 POLEA 38042 POLEA 38043 POLEA LOCA 38020 POLEA LOCA K060910 SERPENTIN K060790 SERPENTIN	CON LLAVE REGULAR SIN LLAVE REGULAR (16 lbs) Sin Palanca (16 lbs) Con palanca 195°F  PRESION C/AA C/AA CON CANALES AJUSTABLE  C/AA, C/DH C/Volante del lado derecho  CON LLAVE C/CONT. DE EMI: SIN LLAVE C/CONT. DE EMI CON LLAVE REGULAR SIN LLAVE REGULAR (16 lbs) Con palanca (16 lbs) Sin Palanca 195°F 195°F C/Volante del lado izquierdo C/Volante del lado izquierdo PRESION C/AA C/AA FIJO/ESTATICA AJUSTABLE CON CANALES  C/AA C/AA, C/DH S/AA, C/DH  CON LLAVE C/CONT. DE EMI: SIN LLAVE C/CONT. DE EMI CON LLAVE REGULAR CON LLAVE REGULAR SIN LLAVE REGULAR (16 lbs) Con palanca (16 lbs) Sin Palanca 195°F PRESION C/AA C/AA AJUSTABLE FIJO/ESTATICA S/AA, S/DH S/AA, C/DH C/AA  SIN LLAVE REGULAR CON LLAVE C/CONT. DE EMI: SIN LLAVE C/CONT. DE EMI CON LLAVE REGULAR SIN LLAVE REGULAR CON LLAVE REGULAR (16 lbs) Sin Palanca 195°F PRESION C/AA & S/AA S/AA C/AA & S/AA S/AA FIJO/ESTATICA CON CANALES AJUSTABLE  C/AA S/AA
V-6, 3.0 L	2003	22839 MANG. INF. 22509 MANG. INF. 22510 MANG. SUP. K061080 SERPENTIN	C/ENFRIADOR DE ACEITE S/ENFRIADOR DE ACEITE				
V-8, 4.0 L	2003	19807 MANG. A TUBO-1 A TERMOSTA 19806 MANG. B.A. 19030 MANG. CALEF. A TUBO DE CALI 28475 MANG. INF. 18787 MANG. SUP. 19285 MANG. SUP. 22562 MANG. SUP. 19754 MANG. VALV. A CALEF. A B.A. 38001 POLEA LOCA K060938 SERPENTIN	AUX. A TUBO-1  CALEFACTOR A TUBO DE CA CALEFACTOR A TUBO DE CA VALVULA DE CALEFACTOR A	6 CIL, 4.0 L	2000		
V-6, 3.0 L	2002	22509 MANGUERA INF. K061080 SERPENTIN	S/Enfriador de aceite				
V-8, 4.0 L	2002	19806 B.A. AUX. A TUBO-1 28475 CALEF. A TUBO AL CALEF. INF. 19030 CALEF. A TUBO AL CALEF. MED 18787 CALEF. A TUBO AL CALEF. SUP 24022 MANGUERA DE PASO 22562 MANGUERA SUP. 38001 POLEA DEL TENSOR K060938 SERPENTIN 38279 TENSOR MICRO-V 28408 TERMOSTATO A TANQUE DE RI 19807 TUBO-1 A TERMOSTATO 19285 VALV. CALEF. A TUBO CALEF.S 19754 VALV. DEL CALEF. A B.A. AUX.		6 CIL, 4.0 L	1999		
V-6, 3.0 L	2001	22509 MANGUERA INF. K061098 SERPENTIN K061080 SERPENTIN	S/Enf de Aceite Motor NS L75998 & Antes Motor NS L75999 & Después				
V-8, 4.0 L	2001	19030 CALEF. A TUBO AL CALEF. MED 18787 CALEF. A TUBO AL CALEF. SUP 22562 MANGUERA SUP. 38001 POLEA K060938 SERPENTIN 38279 TENSOR MICRO-V 19285 VALV. CALEF. A TUBO CALEF.S 19754 VALV. DEL CALEF. A B.A. AUX.		4 CIL, 2.5 L	1998		
V-6, 3.0 L	2000	22509 MANGUERA INF. K061080 SERPENTIN K061098 SERPENTIN	S/Enf de Aceite Motor NS L75998 & Después Motor NS L75998 & Antes				
V-8, 4.0 L	2000	19030 CALEF. A TUBO AL CALEF. MED 18787 CALEF. A TUBO AL CALEF. SUP 22562 MANGUERA SUP. 38001 POLEA K060938 SERPENTIN 38279 TENSOR MICRO-V 19285 VALV. CALEF. A TUBO CALEF.S 19754 VALV. DEL CALEF. A B.A. AUX.					
<b>JEEP</b>							
<b>CHEROKEE</b>							
6 CIL, 4.0 L	2001	19039 CALEF. A MOTOR 19038 CALEF. A TUBO 80290 EDH 21615 MANGUERA INF. 21821 MANGUERA SUP. 38019 POLEA 38042 POLEA K060950 SERPENTIN 31118 TAPON DE ACEITE	PRESION  CON CANALES AJUSTABLE C/AA, C/DH	6 CIL, 4.0 L	1998		



    				    				
6 CIL, 4.0 L	1998	31066	TAPON DE ACEITE	SIN LLAVE C/CONT. DE EMIS CON LLAVE C/CONT. DE EMIS: CON LLAVE REGULAR SIN LLAVE REGULAR CON LLAVE REGULAR V-8, 5.7 L SIN LLAVE REGULAR (16 lbs) Sin Palanca 195°F PRESION C/AA & S/AA S/AA C/AA C/AA S/AA, S/DH S/AA, C/DH	2006	31838	TAPON DE GASOLINA	CON LLAVE 18 LIBRAS 203°F
		31615	TAPON DE GASOLINA			31836	TAPON DE GASOLINA	
		31734	TAPON DE GASOLINA			31525	TAPON DE RADIADOR	
		31778	TAPON DE GASOLINA			38323	SENSOR MICRO-V	
		31748	TAPON DE GASOLINA			34053	TERMOSTATO	
		31836	TAPON DE GASOLINA			23036	MANGUERA INF.	
		31838	TAPON DE GASOLINA			23035	MANGUERA SUP.	
		31523	TAPON DE RADIADOR			38018	POLEA	
		33509	TERMOSTATO			K060820	SERPENTIN	
		4 CIL, 2.5 L	1997			360970(718)	EDH	
20559	MANGUERA INF.			31838	TAPON DE GASOLINA			
21087	MANGUERA SUP.			31836	TAPON DE GASOLINA			
22069	MANGUERA SUP.			31525	TAPON DE RADIADOR			
38042	POLEA			38323	SENSOR MICRO-V			
38043	POLEA			34053	TERMOSTATO			
K060910	SERPENTIN							
K060775	SERPENTIN							
K060790	SERPENTIN							
31066	TAPON DE ACEITE							

## COMPASS

6 CIL, 4.0 L	1997	80290	EDH	CON LLAVE C/CONT. DE EMIS SIN LLAVE REGULAR CON LLAVE REGULAR CON LLAVE C/CONT. DE EMIS: CON LLAVE REGULAR SIN LLAVE REGULAR (16 lbs) Sin Palanca 195°F PRESION C/AA C/AA CON CANALES C/POLEA 90 mm C/POLEA 76 mm C/AA S/AA	2009	37018P	POLEA DECOPLADORA	CON A.A. C/CVT CON A.A. T.M. SIN A.A. CON LLAVE 16 LBS. 180° SIN A.A. CON A.A. T.M. CON A.A. C/CVT CON LLAVE 16 LBS. 180° CON A.A.: C/CVT CON A/A; CON TRANSMISION SIN A.A. 16 LIBRAS 180° CON A/A; CON TRANSMISION CON A.A.: C/CVT SIN A.A. 16 LIBRAS 180°
		21615	MANGUERA INF.			K061005	SERPENTIN	
		21821	MANGUERA SUP.			K061015	SERPENTIN	
		38043	POLEA			K060802	SERPENTIN	
		38042	POLEA			31118	TAPON DE ACEITE	
		38019	POLEA			31836	TAPON DE GASOLINA	
		38020	POLEA LOCA			31838	TAPON DE GASOLINA	
		38043	POLEA LOCA			31528	TAPONES DE RADIADOR	
		K060950	SERPENTIN			39053	SENSOR	
		K060790	SERPENTIN			33941	TERMOSTATOS	
4 CIL, 2.4 L	2008	31118	TAPON DE ACEITE	CON LLAVE C/CONT. DE EMIS: SIN LLAVE REGULAR SIN LLAVE REGULAR CON LLAVE REGULAR CON LLAVE REGULAR SIN LLAVE REGULAR (16 lbs) Sin Palanca 195°F	2007	37018P	POLEA DECOPLADORA	CON A.A.: C/CVT CON A/A; CON TRANSMISION SIN A.A. 16 LIBRAS 180° CON A/A; CON TRANSMISION CON A.A.: C/CVT SIN A.A. 16 LIBRAS 180°
		31734	TAPON DE GASOLINA			K061005	SERPENTIN	
		31615	TAPON DE GASOLINA			K061015	SERPENTIN	
		31748	TAPON DE GASOLINA			K060802	SERPENTIN	
		31778	TAPON DE GASOLINA			31118	TAPON DE ACEITE	
		31836	TAPON DE GASOLINA			31836	TAPON DE GASOLINA	
		31838	TAPON DE GASOLINA			31838	TAPON DE GASOLINA	
		31523	TAPON DE RADIADOR			31528	TAPON DE RADIADOR	
		33509	TERMOSTATO			39053	SENSOR	
						33941	TERMOSTATOS	

## COMMANDER









V-8, 5.7 L	2009	23036	MANGUERA INF.	CON LLAVE 18 LIBRAS. 203°	2007	37018P	POLEA DECOPLADORA	CON A/A; CON TRANSMISION CON A.A.: C/CVT SIN A.A. 16 LIBRAS 180°
		23035	MANGUERA SUP.			K061015	SERPENTIN	
		38018	POLEA			K061005	SERPENTIN	
		36313	POLEA DEL TENSOR			K060802	SERPENTIN	
		K060825	SERPENTIN			31118	TAPON DE ACEITE	
		31118	TAPON DE ACEITE			31838	TAPON DE GASOLINA	
		31838	TAPON DE GASOLINA			31836	TAPON DE GASOLINA	
		31836	TAPON DE GASOLINA			31528	TAPON DE RADIADOR	
		31535	TAPONES DE RADIADOR			39053	SENSOR	
		38323	SENSOR			33941	TERMOSTATOS	

## GRAND CHEROKEE











V-8, 5.7 L	2008	23036	MANGUERA INF.	CON LLAVE 18 LIBRAS 203°F	2009	19508	MANGUERA CALEFACCION	ENTRADA SALIDA CON LLAVE ENTRADA
		23035	MANGUERA SUP.			19509	MANGUERA CALEFACCION	
		38018	POLEA			23040	MANGUERA INF.	
		K060820	SERPENTIN			23039	MANGUERA SUP.	
		31118	TAPON DE ACEITE			K060888	SERPENTIN	
		31838	TAPON DE GASOLINA			31838	TAPON DE GASOLINA	
		31836	TAPON DE GASOLINA			31836	TAPON DE GASOLINA	
		31525	TAPON DE RADIADOR			31525	TAPONES DE RADIADOR	
		38323	SENSOR MICRO-V			19514	MANGUERA CALEFACCION	
		34053	TERMOSTATO			23036	MANGUERA INF.	
V-8, 5.7 L	2007	23036	MANGUERA INF.	CON LLAVE 18 LIBRAS 203°F	2009	23035	MANGUERA SUP.	ENTRADA SALIDA CON LLAVE ENTRADA
		23035	MANGUERA SUP.			38018	POLEA	
		38018	POLEA			36313	POLEA DEL TENSOR	
		K060820	SERPENTIN			K060820	SERPENTIN	
		31118	TAPON DE ACEITE			31118	TAPON DE ACEITE	













V-6, 4.0 L	2003	19235	CALEF. A MOTOR		V-8, 4.7 L		BDH-61607	BOMBA DE DIR. HIDR.	
		19235	CALEF. A TUBO				18922	CALEF. A TUBO-1	
		22483	MANGUERA INF.				19102	CALEF. A TUBO-2	
		22484	MANGUERA SUP.				22661	MANGUERA INF.	
		38018	POLEA				22486	MANGUERA SUP.	
		38043	POLEA LOCA				38001	POLEA	
		K060882	SERPENTIN	C/AA			38009	POLEA	
		31118	TAPON DE ACEITE				K060874	SERPENTIN	C/AA
		31838	TAPON DE GASOLINA	SIN LLAVE REGULAR			31118	TAPON DE ACEITE	
		31525	TAPON DE RADIADOR	(18 lbs) Sin Palanca			31278	TAPON DE ACEITE	
		33009	TERMOSTATO	195°F			31838	TAPON DE GASOLINA	SIN LLAVE REGULAR
V-8, 4.7 L	2003	18922	CALEF. A TUBO-1				31836	TAPON DE GASOLINA	CON LLAVE REGULAR
		19102	CALEF. A TUBO-2				31522	TAPON DE RADIADOR	(20 lbs) Sin Palanca
		22661	MANGUERA INF.				31525	TAPON DE RADIADOR	(18 lbs) Sin Palanca
		22486	MANGUERA SUP.				38167	SENSOR MICRO-V	
		38001	POLEA				33919	TERMOSTATO	195°F
		38009	POLEA				19156	TUBO-1 A MOTOR	
		38042	POLEA LOCA				19035	TUBO-2 A MOTOR	
		K060874	SERPENTIN	C/AA	6 CIL, 4.0 L	2000	BDH-61607	BOMBA DE DIR. HIDR.	
		31838	TAPON DE GASOLINA	SIN LLAVE REGULAR			80290	EDH	PRESION
		31525	TAPON DE RADIADOR	(18 lbs) Sin Palanca			21615	MANGUERA INF.	
		38167	SENSOR MICRO-V				22483	MANGUERA INF.	
		19156	TUBO-1 A MOTOR				21821	MANGUERA SUP.	
		19035	TUBO-2 A MOTOR				22484	MANGUERA SUP.	
6 CIL, 4.0 L	2002	19235	CALEF. A MOTOR				38043	POLEA	
		19235	CALEF. A TUBO				38018	POLEA	
		353090(803)	EDH	PRESION			K060882	SERPENTIN	
		22483	MANGUERA INF.				31118	TAPON DE ACEITE	
		22484	MANGUERA SUP.				31734	TAPON DE GASOLINA	CON LLAVE C/CONT. DE EMIS
		38018	POLEA				31748	TAPON DE GASOLINA	SIN LLAVE REGULAR
		38043	POLEA LOCA				31615	TAPON DE GASOLINA	SIN LLAVE C/CONT. DE EMIS
		38043	POLEA LOCA				31778	TAPON DE GASOLINA	CON LLAVE REGULAR
		K060882	SERPENTIN	C/AA			31838	TAPON DE GASOLINA	SIN LLAVE REGULAR
		31118	TAPON DE ACEITE				31525	TAPON DE RADIADOR	(18 lbs) Sin Palanca
		31836	TAPON DE GASOLINA	CON LLAVE REGULAR			31523	TAPON DE RADIADOR	(16 lbs) Sin Palanca
		31838	TAPON DE GASOLINA	SIN LLAVE REGULAR			38163	SENSOR MICRO-V	
		31525	TAPON DE RADIADOR	(18 lbs) Sin Palanca			33009	TERMOSTATO	195°F
		38163	SENSOR MICRO-V				K060882	SERPENTIN	C/AA
		33009	TERMOSTATO	195°F	V-8, 4.0 L	2000	K060874	SERPENTIN	C/AA
V-8, 4.7 L	2002	18922	CALEF. A TUBO-1				31118	TAPON DE ACEITE	
		19102	CALEF. A TUBO-2				31615	TAPON DE GASOLINA	SIN LLAVE C/CONT. DE EMIS
		22661	MANGUERA INF.				31778	TAPON DE GASOLINA	CON LLAVE REGULAR
		22486	MANGUERA SUP.				31734	TAPON DE GASOLINA	CON LLAVE C/CONT. DE EMIS
		38001	POLEA				31748	TAPON DE GASOLINA	SIN LLAVE REGULAR
		38009	POLEA				31525	TAPON DE RADIADOR	(18 lbs) Sin Palanca
		38042	POLEA LOCA				K060874	SERPENTIN	
		K060874	SERPENTIN	C/AA	V-8, 4.7 L	2000	BDH-61607	BOMBA DE DIR. HIDR.	
		31118	TAPON DE ACEITE				18922	CALEF. A TUBO-1	
		31836	TAPON DE GASOLINA	CON LLAVE REGULAR			19102	CALEF. A TUBO-2	
		31838	TAPON DE GASOLINA	SIN LLAVE REGULAR			22485	MANGUERA INF.	
		31522	TAPON DE RADIADOR	(20 lbs) Sin Palanca			22486	MANGUERA SUP.	
		31525	TAPON DE RADIADOR	(18 lbs) Sin Palanca			38009	POLEA	
		38167	SENSOR MICRO-V				38001	POLEA	
		19156	TUBO-1 A MOTOR				K060874	SERPENTIN	C/AA
		19035	TUBO-2 A MOTOR				31118	TAPON DE ACEITE	
		BDH-61607	BOMBA DE DIR. HIDR.				31278	TAPON DE ACEITE	
		22483	MANG. INF.				31778	TAPON DE GASOLINA	CON LLAVE REGULAR
		22484	MANGUERA SUP.				31748	TAPON DE GASOLINA	CON LLAVE C/CONT. DE EMIS
		38018	POLEA				31615	TAPON DE GASOLINA	SIN LLAVE C/CONT. DE EMIS
		38043	POLEA				31522	TAPON DE RADIADOR	(20 lbs) Sin Palanca
		38043	POLEA LOCA				31525	TAPON DE RADIADOR	(18 lbs) Sin Palanca
		K060882	SERPENTIN	C/AA			38167	SENSOR MICRO-V	
		31118	TAPON DE ACEITE				33919	TERMOSTATO	195°F
		31836	TAPON DE GASOLINA	CON LLAVE REGULAR			19156	TUBO-1 A MOTOR	
		31838	TAPON DE GASOLINA	SIN LLAVE REGULAR			19035	TUBO-2 A MOTOR	
		31525	TAPON DE RADIADOR	(18 lbs) Sin Palanca	6 CIL, 4.0 L	1999	BDH-61607	BOMBA DE DIR. HIDR.	
		38163	SENSOR MICRO-V				21615	MANGUERA INF.	
		33509	TERMOSTATO	195°F			22483	MANGUERA INF.	
		33009	TERMOSTATO	195°F			21821	MANGUERA SUP.	
V-8, 4.0 L	2001	K060882	SERPENTIN	C/AA			22484	MANGUERA SUP.	
		K060874	SERPENTIN	C/AA			38043	POLEA	
		31118	TAPON DE ACEITE				38018	POLEA	
		31838	TAPON DE GASOLINA	SIN LLAVE REGULAR			38043	POLEA LOCA	
		31836	TAPON DE GASOLINA	CON LLAVE REGULAR			38020	POLEA LOCA	
		31525	TAPON DE RADIADOR	(18 lbs) Sin Palanca			K060882	SERPENTIN	











   				   					
6 CIL, 4.0 L	1999	31118 31615 31748 31778 31734 31525 38163 33009	TAPON DE ACEITE TAPON DE GASOLINA TAPON DE GASOLINA TAPON DE GASOLINA TAPON DE GASOLINA TAPON DE RADIADOR TENSOR MICRO-V TERMOSTATO	SIN LLAVE C/CONT. DE EMIS SIN LLAVE REGULAR CON LLAVE REGULAR CON LLAVE C/CONT. DE EMI: (18 lbs) Sin Palanca		31118 31778 31734 31615 31748 31525 38116 33509	TAPON DE ACEITE TAPON DE GASOLINA TAPON DE GASOLINA TAPON DE GASOLINA TAPON DE GASOLINA TAPON DE RADIADOR TENSOR MICRO-V TERMOSTATO	CON LLAVE REGULAR CON LLAVE C/CONT. DE EMI: SIN LLAVE C/CONT. DE EMIS SIN LLAVE REGULAR (18 lbs) Sin Palanca	
V-8, 4.0 L	1999	K060882 31118 31748 31734 31778 31615 31525	SERPENTIN TAPON DE ACEITE TAPON DE GASOLINA TAPON DE GASOLINA TAPON DE GASOLINA TAPON DE GASOLINA TAPON DE RADIADOR	195°F C/AA SIN LLAVE REGULAR CON LLAVE C/CONT. DE EMI: CON LLAVE REGULAR SIN LLAVE C/CONT. DE EMIS (18 lbs) Sin Palanca	6 CIL, 4.0 L	1997	BDH-7111 92023 21971 21970 38042 K060919	BOMBA DE DIR. HIDR. EDH MANGUERA INF. MANGUERA SUP. POLEA LOCA SERPENTIN	195°F PRESION C/ASISTENCIA AJUSTABLE
V-8, 4.7 L	1999	BDH-61607 18922 19102 22485 22486 38001 38009 K060874 31118 31278 31734 31748 31778 31615 31525 31522 38167 33919 19156 19035	BOMBA DE DIR. HIDR. CALEF. A TUBO-1 CALEF. A TUBO-2 MANGUERA INF. MANGUERA SUP. POLEA POLEA SERPENTIN TAPON DE ACEITE TAPON DE ACEITE TAPON DE GASOLINA TAPON DE GASOLINA TAPON DE GASOLINA TAPON DE GASOLINA TAPON DE RADIADOR TAPON DE RADIADOR TENSOR MICRO-V TERMOSTATO TUBO-1 A MOTOR TUBO-2 A MOTOR	C/AA CON LLAVE C/CONT. DE EMI: SIN LLAVE REGULAR CON LLAVE REGULAR SIN LLAVE C/CONT. DE EMIS (18 lbs) Sin Palanca (20 lbs) Sin Palanca 195°F	V-8, 5.2 L	1997	BDH-7111 92023 22038 21995 21998 38016 38033 K070890 31118 31748 31778 31734 31615 31525 38116 33509	BOMBA DE DIR. HIDR. EDH MANGUERA DE PASO MANGUERA INF. MANGUERA SUP. POLEA POLEA SERPENTIN TAPON DE ACEITE TAPON DE GASOLINA TAPON DE GASOLINA TAPON DE GASOLINA TAPON DE GASOLINA TAPON DE RADIADOR TENSOR MICRO-V TERMOSTATO	PRESION C/ASISTENCIA PRESION C/ASISTENCIA AJUSTABLE FIJO/ESTATICA CON LLAVE C/CONT. DE EMI: SIN LLAVE REGULAR CON LLAVE REGULAR SIN LLAVE C/CONT. DE EMIS (18 lbs) Sin Palanca 195°F
6 CIL, 4.0 L	1998	BDH-7111 92023 353090(803) 21971 21970 38042 38043 38020 38043 K060919 K060923 31118 31615 31748 31778 31525 33509	BOMBA DE DIR. HIDR. EDH EDH MANGUERA INF. MANGUERA SUP. POLEA POLEA POLEA LOCA POLEA LOCA SERPENTIN SERPENTIN TAPON DE ACEITE TAPON DE GASOLINA TAPON DE GASOLINA TAPON DE GASOLINA TAPON DE GASOLINA TERMOSTATO	PRESION C/ASISTENCIA PRESION AJUSTABLE FIJO/ESTATICA SIN LLAVE C/CONT. DE EMIS SIN LLAVE REGULAR CON LLAVE REGULAR (18 lbs) Sin Palanca 195°F		1998	BDH-7111 92023 22038 21995 21998 38033 38016 K070890 31118 31734 31748 31778 31615 31525 38116 33509	BOMBA DE DIR. HIDR. EDH MANGUERA DE PASO MANGUERA INF. MANGUERA SUP. POLEA POLEA SERPENTIN TAPON DE ACEITE TAPON DE GASOLINA TAPON DE GASOLINA TAPON DE GASOLINA TAPON DE GASOLINA TAPON DE RADIADOR TENSOR MICRO-V TERMOSTATO	PRESION C/ASISTENCIA PRESION C/ASISTENCIA AJUSTABLE V-6, 3.7 L SIN LLAVE C/CONT. DE EMIS SIN LLAVE REGULAR CON LLAVE REGULAR (18 lbs) Sin Palanca 195°F
V-8, 5.2 L	1998	BDH-7111 92023 22038 21995 21998 38033 38016 K070890 31118 31734 31748 31778 31615 31525 38116 33509	BOMBA DE DIR. HIDR. EDH MANGUERA DE PASO MANGUERA INF. MANGUERA SUP. POLEA POLEA SERPENTIN TAPON DE ACEITE TAPON DE GASOLINA TAPON DE GASOLINA TAPON DE GASOLINA TAPON DE GASOLINA TAPON DE RADIADOR TENSOR MICRO-V TERMOSTATO	PRESION C/ASISTENCIA PRESION C/ASISTENCIA AJUSTABLE V-6, 3.7 L SIN LLAVE C/CONT. DE EMI: SIN LLAVE REGULAR CON LLAVE REGULAR SIN LLAVE C/CONT. DE EMIS (18 lbs) Sin Palanca 195°F	V-6, 3.7 L	2007	BDH-64610 21739 22718 22719 38009 38001 38042 K060868	BOMBA DE DIR. HIDR. MANG. INF. MANG. INF. MANG. SUP. POLEA POLEA POLEA LOCA SERPENTIN TAPON DE ACEITE TAPON DE GASOLINA TAPON DE RADIADOR TENSOR MICRO-V TERMOSTATO	MOTOR A TUBO-1 MOTOR A TUBO-1 MOTOR A TUBO-1 MOTOR A TUBO-1
V-8, 5.9 L	1998	92023 22038 21995 21998 38033 38016 K070890	EDH MANGUERA DE PASO MANGUERA INF. MANGUERA SUP. POLEA POLEA SERPENTIN	PRESION C/ASISTENCIA PRESION C/ASISTENCIA AJUSTABLE V-6, 3.7 L SIN LLAVE C/CONT. DE EMI: SIN LLAVE REGULAR CON LLAVE REGULAR SIN LLAVE C/CONT. DE EMIS (18 lbs) Sin Palanca 195°F	V-6, 3.7 L	2006	BDH-64610 21739 22718 22719 38009 38001 38042 K060868	BOMBA DE DIR. HIDR. MANG. INF. MANG. INF. MANG. SUP. POLEA POLEA POLEA LOCA SERPENTIN	MOTOR A TUBO-1 MOTOR A TUBO-1 MOTOR A TUBO-1 MOTOR A TUBO-1

## LIBERTY

    				    					
V-6, 3.7 L	2006	31278 31838 31528 38167 33919	TAPON DE ACEITE TAPON DE GASOLINA TAPON DE RADIADOR SENSOR MICRO-V TERMOSTATO	SIN LLAVE REGULAR (16 lbs) Sin Palanca  195°F		K061015 K061005 K060802 31118 31836 31838 31528 39053 33941	SERPENTIN SERPENTIN SERPENTIN TAPON DE ACEITE TAPON DE GASOLINA TAPON DE GASOLINA TAPON DE RADIADOR SENSOR TERMOSTATOS	CON A/A; CON TRANSMISION CON A.A.; C/CVT SIN A.A.   16 LIBRAS  180°	
V-6, 3.7 L	2005	BDH-64610 21739 22718 22719 38042 38001 38009 K060868 31278 31838 31528 38167 33919	BOMBA DE DIR. HIDR. MANGUERA INF. MANGUERA INF. MANGUERA SUP. POLEA POLEA POLEA SERPENTIN TAPON DE ACEITE TAPON DE GASOLINA TAPON DE RADIADOR SENSOR MICRO-V TERMOSTATO	LOCA   4 CIL, 2.4 L   SIN LLAVE REGULAR (16 lbs) Sin Palanca  195°F		2007 37018P K061015 K061005 K060802 31118 31836 31838 31528 39053 33941	POLEA DECOPLADORA SERPENTIN SERPENTIN SERPENTIN TAPON DE ACEITE TAPON DE GASOLINA TAPON DE GASOLINA TAPON DE RADIADOR SENSOR TERMOSTATOS	CON A/A; CON TRANSMISION CON A.A.; C/CVT SIN A.A.  16 LIBRAS  180°	
V-6, 3.7 L	2004	BDH-64610 22718 22719 38001 38009 K060868 31278 31838 31528 38167 33919	BOMBA DE DIR. HIDR. MANGUERA INF. MANGUERA SUP. POLEA POLEA SERPENTIN TAPON DE ACEITE TAPON DE GASOLINA TAPON DE RADIADOR SENSOR MICRO-V TERMOSTATO	C/AA   SIN LLAVE REGULAR (16 lbs) Sin Palanca  195°F					
V-6, 3.7 L	2003	BDH-64610 22718 22719 38001 38009 38042 K060874 31838 31528 38167 33919	BOMBA DE DIR. HIDR. MANGUERA INF. MANGUERA SUP. POLEA POLEA POLEA LOCA SERPENTIN TAPON DE GASOLINA TAPON DE RADIADOR SENSOR MICRO-V TERMOSTATO	C/AA   SIN LLAVE REGULAR (16 lbs) Sin Palanca  195°F					
V-6, 3.7 L	2002	BDH-64610 22718 22719 38001 38009 38042 K060874 31838 31528 38167 33919	BOMBA DE DIR. HIDR. MANGUERA INF. MANGUERA SUP. POLEA POLEA POLEA LOCA SERPENTIN TAPON DE GASOLINA TAPON DE RADIADOR SENSOR MICRO-V TERMOSTATO	SIN LLAVE REGULAR (18 lbs) Sin Palanca  195°F					
<b>WRANGLER</b>									
					V-6, 3.8 L	2010	19482 23234 23233 K060900 K060825 38018	MANGUERA CALEFACCION MANGUERA INF. MANGUERA SUP. SERPENTIN SERPENTIN SENSOR	ENTRADA   CON A.A. SIN A.A.
					V-6, 3.8 L	2009	19482 23234 23233 K060900 31118 31838 31836 31528 38018 33849	MANGUERA CALEFACCION MANGUERA INF. MANGUERA SUP. SERPENTIN TAPON DE ACEITE TAPON DE GASOLINA TAPON DE GASOLINA TAPONES DE RADIADOR SENSOR TERMOSTATOS	ENTRADA     CON LLAVE 16 LBS.  195° ENTRADA
					V-6, 3.8 L	2008	19482 23234 23233 K060900 31118 31838 31836 31528 38018 33849	MANGUERA CALEFACCION MANGUERA INF. MANGUERA SUP. SERPENTIN TAPON DE ACEITE TAPON DE GASOLINA TAPONES DE RADIADOR SENSOR TERMOSTATOS	CON LLAVE 16 LBS.  195°
					V-6, 3.8 L	2007	K060900 31118 31838 31535 33849	SERPENTIN TAPON DE ACEITE TAPON DE GASOLINA TAPON DE RADIADOR TERMOSTATO	SIN LLAVE REGULAR (18 lbs) Con Palanca 195°F
					4 CIL, 2.4 L	2006	T265 38006 38018 T42121 K060919 K060849 31118 31838 31525 T43008 38185 19039 19126 20931 22282 38043 38018 K060750 K060882 31118 31838 31535	BANDA ARBOL DE LEVAS POLEA POLEA POLEA BANDA DE TIEMPO SERPENTIN SERPENTIN TAPON DE ACEITE TAPON DE GASOLINA TAPON DE RADIADOR SENSOR ARBOL DE LEVAS SENSOR MICRO-V MANG. DE CALEFACCION MANG. DE CALEFACCION MANG. INF. MANG. SUP. POLEA POLEA SERPENTIN SERPENTIN TAPON DE ACEITE TAPON DE GASOLINA TAPON DE RADIADOR	{146 D x 28.0 mm}   C/AA S/AA  SIN LLAVE REGULAR (18 lbs) Sin Palanca  CALEFACCION A TUBO CALETACCION A TERMOST   S/AA C/AA  SIN LLAVE REGULAR (18 lbs) Con Palanca
<b>PATRIOT</b>									
4 CIL, 2.4 L	2010	37018P K061015 K060802 K061005 31118 31838 31836 31528 39053 33941	POLEA DECOPLADORA SERPENTIN SERPENTIN SERPENTIN TAPON DE ACEITE TAPON DE GASOLINA TAPON DE GASOLINA TAPONES DE RADIADOR SENSOR TERMOSTATOS	CON A.A. T.M. SIN A.A. CON A.A. C/CVT  CON LLAVE 16 LBS.  180°					
4 CIL, 2.4 L	2009	37018P K061005 K060802 K061015 31118 31836 31838 31528 39053 33941	POLEA DECOPLADORA SERPENTIN SERPENTIN SERPENTIN TAPON DE ACEITE TAPON DE GASOLINA TAPON DE GASOLINA TAPONES DE RADIADOR SENSOR TERMOSTATOS	CON A.A. C/CVT SIN A.A. CON A.A. T.M.  CON LLAVE 16 LBS.  180°	6 CIL, 4.0 L	2006			
4 CIL, 2.4 L	2008	37018P	POLEA DECOPLADORA						



    			    				
6 CIL, 4.0 L	2006	38163 TENSOR MICRO-V			31525 TAPON DE RADIADOR	(18 lbs) Sin Palanca	
4 CIL, 2.4 L	2005	T265 BANDA ARBOL DE LEVAS		6 CIL, 4.0 L	2002	33509 TERMOSTATO	195°F
		38018 POLEA			20931 MANGUERA INF.		
		38006 POLEA			22282 MANGUERA SUP.		
		T42121 POLEA BANDA DE TIEMPO			38043 POLEA		
		K060919 SERPENTIN	C/AA		38018 POLEA		
		K060849 SERPENTIN	S/AA		38043 POLEA LOCA		
		31118 TAPON DE ACEITE			K060790 SERPENTIN	S/AA	
		31838 TAPON DE GASOLINA	SIN LLAVE REGULAR		K060882 SERPENTIN	C/AA	
		31525 TAPON DE RADIADOR	(18 lbs) Sin Palanca		31118 TAPON DE ACEITE		
		T43008 TENSOR ARBOL DE LEVAS			31838 TAPON DE GASOLINA	SIN LLAVE REGULAR	
6 CIL, 4.0 L	2005	38185 TENSOR MICRO-V		4 CIL, 2.5 L	2001	31525 TAPON DE RADIADOR	(18 lbs) Sin Palanca
		19039 MANGUERA DE CALEF.			38163 TENSOR MICRO-V		
		19126 MANGUERA DE CALEF.			33009 TERMOSTATO	195°F	
		20931 MANGUERA INF.			80292 EDH	PRESION	
		22282 MANGUERA SUP.			22280 MANGUERA INF.		
		38043 POLEA			22281 MANGUERA SUP.		
		38018 POLEA			38042 POLEA		
		K060750 SERPENTIN			38043 POLEA		
		K060882 SERPENTIN			38020 POLEA DEL TENSOR		
		31118 TAPON DE ACEITE			38043 POLEA LOCA		
		31838 TAPON DE GASOLINA	SIN LLAVE REGULAR		K060923 SERPENTIN	C/AA	
		31535 TAPON DE RADIADOR	(18 lbs) Con Palanca		K060790 SERPENTIN	S/AA	
4 CIL, 2.4 L	2004	38163 TENSOR MICRO-V			31066 TAPON DE ACEITE		
		T265 BANDA ARBOL DE LEVAS		6 CIL, 4.0 L	2001	31748 TAPON DE GASOLINA	SIN LLAVE REGULAR
		38006 POLEA			31525 TAPON DE RADIADOR	(18 lbs) Sin Palanca	
		38018 POLEA			33509 TERMOSTATO	195°F	
		T42121 POLEA BANDA DE TIEMPO			80293 EDH	PRESION	
		K060919 SERPENTIN	C/AA		20931 MANGUERA INF.		
		K060849 SERPENTIN	S/AA		22282 MANGUERA SUP.		
		31118 TAPON DE ACEITE			38043 POLEA		
		31838 TAPON DE GASOLINA	SIN LLAVE REGULAR		38018 POLEA		
		31525 TAPON DE RADIADOR	(18 lbs) Sin Palanca		K060790 SERPENTIN	S/AA	
		T43008 TENSOR ARBOL DE LEVAS			K060882 SERPENTIN	C/AA, C/DH	
V-6, 4.0 L	2004	38185 TENSOR MICRO-V			31118 TAPON DE ACEITE		
		20931 MANGUERA INF.		4 CIL, 2.5 L	2000	31838 TAPON DE GASOLINA	SIN LLAVE REGULAR
		22282 MANGUERA SUP.			31525 TAPON DE RADIADOR	(18 lbs) Sin Palanca	
		K060750 SERPENTIN	S/AA		38163 TENSOR MICRO-V		
		K060882 SERPENTIN	C/AA		33509 TERMOSTATO	195°F	
		31118 TAPON DE ACEITE			19037 CALEF. A TERMOSTATO		
		31836 TAPON DE GASOLINA	CON LLAVE REGULAR		19004 CALEF. A TUBO		
		31535 TAPON DE RADIADOR	(18 lbs) Con Palanca		80292 EDH	PRESION	
4 CIL, 2.4 L	2003	T265 BANDA ARBOL DE LEVAS			22280 MANGUERA INF.		
		22280 MANGUERA INF.			22281 MANGUERA SUP.		
		22281 MANGUERA SUP.			38043 POLEA	FIJO/ESTATICA	
		38018 POLEA			38042 POLEA	AJUSTABLE	
		38006 POLEA			38001 POLEA LOCA		
		T42121 POLEA BANDA DE TIEMPO			38043 POLEA LOCA		
		K060919 SERPENTIN	C/AA		38020 POLEA LOCA AJUSTABLE		
		31118 TAPON DE ACEITE			K060910 SERPENTIN	C/AA, C/DH	
		31838 TAPON DE GASOLINA	SIN LLAVE REGULAR		K060790 SERPENTIN	S/AA, C/DH	
		31525 TAPON DE RADIADOR	(18 lbs) Sin Palanca		31066 TAPON DE ACEITE		
		T43008 TENSOR ARBOL DE LEVAS			31615 TAPON DE GASOLINA	SIN LLAVE C/CONT. DE EMIS	
		38185 TENSOR MICRO-V			31748 TAPON DE GASOLINA	SIN LLAVE REGULAR	
6 CIL, 4.0 L	2003	20931 MANGUERA INF.			31778 TAPON DE GASOLINA	CON LLAVE REGULAR	
		22282 MANGUERA SUP.			31525 TAPON DE RADIADOR	(18 lbs) Sin Palanca	
		38018 POLEA			33509 TERMOSTATO	195°F	
		38043 POLEA LOCA		6 CIL, 4.0 L	2000	80293 EDH	PRESION
		K060750 SERPENTIN	S/AA		20931 MANGUERA INF.	C/AA, C/DH	
		K060882 SERPENTIN	C/AA		22282 MANGUERA SUP.	C/AA, C/DH	
		31118 TAPON DE ACEITE			38043 POLEA		
		31838 TAPON DE GASOLINA	SIN LLAVE REGULAR		38018 POLEA TENSORA		
		31525 TAPON DE RADIADOR	(18 lbs) Sin Palanca		K060950 SERPENTIN	C/AA, C/DH	
		38163 TENSOR MICRO-V			K060882 SERPENTIN	C/AA	
		33009 TERMOSTATO	195°F		K060790 SERPENTIN	S/AA	
4 CIL, 2.5 L	2002	22280 MANGUERA INF.			31778 TAPON DE GASOLINA	CON LLAVE REGULAR	
		22281 MANGUERA SUP.			31615 TAPON DE GASOLINA	SIN LLAVE C/CONT. DE EMIS	
		38043 POLEA			31748 TAPON DE GASOLINA	SIN LLAVE REGULAR	
		38042 POLEA			31734 TAPON DE GASOLINA	CON LLAVE C/CONT. DE EMIS	
		38020 POLEA DEL TENSOR			31525 TAPON DE RADIADOR	(18 lbs) Sin Palanca	
		38043 POLEA LOCA			38163 TENSOR MICRO-V		
		K060923 SERPENTIN	C/AA		33509 TERMOSTATO	195°F	
		K060790 SERPENTIN	S/AA; TRANSMISION DE ACC4 CIL, 2.5 L	1999	19037 CALEF. A TERMOSTATO	C/Volante del lado izquierdo	
		31066 TAPON DE ACEITE			19004 CALEF. A TUBO	C/Volante del lado izquierdo	
		31838 TAPON DE GASOLINA	SIN LLAVE REGULAR		80292 EDH	PRESION	

    				    					
4 CIL, 2.5 L	1999	22281	MANGUERA SUP.	FIJO/ESTATICA AJUSTABLE	C/AA, C/DH S/AA, S/DH S/AA, C/DH	38043	POLEA	POLEA TAPON DE GASOLINA TAPON DE GASOLINA TAPON DE GASOLINA TAPON DE GASOLINA	SIN LLAVE C/CONT. DE EMIS SIN LLAVE REGULAR CON LLAVE REGULAR CON LLAVE C/CONT. DE EMIS
		38043	POLEA						
		38001	POLEA LOCA						
		38043	POLEA LOCA						
		38020	POLEA LOCA AJUSTABLE						
		K060910	SERPENTIN						
		K060775	SERPENTIN						
		K060790	SERPENTIN						
		31066	TAPON DE ACEITE						
		31615	TAPON DE GASOLINA						
		31778	TAPON DE GASOLINA						
		31748	TAPON DE GASOLINA						
		31734	TAPON DE GASOLINA						
		31523	TAPON DE RADIADOR						
		6 CIL, 4.0 L	1999				20931		
22282	MANGUERA SUP.								
38043	POLEA								
38042	POLEA								
38043	POLEA LOCA								
K060923	SERPENTIN								
K060919	SERPENTIN								
K060790	SERPENTIN								
31118	TAPON DE ACEITE								
31748	TAPON DE GASOLINA								
31734	TAPON DE GASOLINA								
31615	TAPON DE GASOLINA								
31778	TAPON DE GASOLINA								
31523	TAPON DE RADIADOR								
4 CIL, 2.5 L	1998			80292	EDH	PRESION	V-8, 4.0 L	2003	22416
		22281	MANGUERA SUP.						
		38019	POLEA						
		38043	POLEA						
		38043	POLEA LOCA						
		38042	POLEA LOCA						
		K060910	SERPENTIN						
		K060790	SERPENTIN						
		K060775	SERPENTIN						
		31066	TAPON DE ACEITE						
		31778	TAPON DE GASOLINA						
		31748	TAPON DE GASOLINA						
		31615	TAPON DE GASOLINA						
		31525	TAPON DE RADIADOR						
		6 CIL, 4.0 L	1998	33509	TERMOSTATO				C/AA, C/DH S/AA, C/DH S/AA
22283	MANGUERA INF.								
22282	MANGUERA SUP.								
38019	POLEA								
38042	POLEA								
38043	POLEA								
K060950	SERPENTIN								
31778	TAPON DE GASOLINA								
31734	TAPON DE GASOLINA								
31748	TAPON DE GASOLINA								
31615	TAPON DE GASOLINA								
33509	TERMOSTATO								
22283	MANGUERA INF.								
22282	MANGUERA SUP.								
4 CIL, 2.5 L	1997			80292	EDH	PRESION	V-8, 4.0 L	2001	
		22281	MANGUERA SUP.						
		38019	POLEA						
		38042	POLEA						
		38043	POLEA						
		38043	POLEA LOCA						
		38020	POLEA LOCA						
		K060910	SERPENTIN						
		K060790	SERPENTIN						
		K060775	SERPENTIN						
		31066	TAPON DE ACEITE						
		31748	TAPON DE GASOLINA						
		31615	TAPON DE GASOLINA						
		31525	TAPON DE RADIADOR						
		6 CIL, 4.0 L	1998	33509	TERMOSTATO				C/AA, C/DH S/AA, C/DH S/AA
22283	MANGUERA INF.								
22282	MANGUERA SUP.								
38019	POLEA								
38042	POLEA								
38043	POLEA								
K060950	SERPENTIN								
31778	TAPON DE GASOLINA								
31734	TAPON DE GASOLINA								
31748	TAPON DE GASOLINA								
31615	TAPON DE GASOLINA								
33509	TERMOSTATO								
22283	MANGUERA INF.								
22282	MANGUERA SUP.								
4 CIL, 2.5 L	1997			80292	EDH	PRESION	V-8, 4.0 L	1999	
		22281	MANGUERA SUP.						
		38019	POLEA						
		38042	POLEA						
		38043	POLEA						
		38043	POLEA LOCA						
		38020	POLEA LOCA						
		K060910	SERPENTIN						
		K060790	SERPENTIN						
		K060775	SERPENTIN						
		31066	TAPON DE ACEITE						
		31748	TAPON DE GASOLINA						
		31615	TAPON DE GASOLINA						
		31778	TAPON DE GASOLINA						
		6 CIL, 4.0 L	1997	33509	TERMOSTATO				C/POLEA 76 mm C/POLEA 90 mm C/AA, C/DH S/AA, C/DH S/AA
22283	MANGUERA INF.								
22282	MANGUERA SUP.								
38019	POLEA								
38042	POLEA								
38043	POLEA								
38043	POLEA LOCA								
38020	POLEA LOCA								
K060910	SERPENTIN								
K060790	SERPENTIN								
K060775	SERPENTIN								
31066	TAPON DE ACEITE								
31748	TAPON DE GASOLINA								
31615	TAPON DE GASOLINA								
6 CIL, 4.0 L	1997			33509	TERMOSTATO	C/AA, C/DH S/AA, C/DH S/AA	V-8, 4.0 L	2000	
		22283	MANGUERA INF.						
		22282	MANGUERA SUP.						
		38019	POLEA						
		38042	POLEA						
		38043	POLEA						
		38043	POLEA LOCA						
		38020	POLEA LOCA						
		K060910	SERPENTIN						
		K060790	SERPENTIN						
		K060775	SERPENTIN						
		31066	TAPON DE ACEITE						
		31748	TAPON DE GASOLINA						
		31615	TAPON DE GASOLINA						

**LAND ROVER**

**DISCOVERY**

**DISCOVERY SERIES II**

V-8, 4.0 L	1999	31331 38245	TAPON DE RADIADOR TENSOR MICRO-V	(20 lbs) Sin palanca

--	--	--	--	--

**LINCOLN**

**FREELANDER**

V-6, 2.5 L	2005	T326 T327 K060612 31109	BANDA ARBOL DE LEVAS BANDA ARBOL DE LEVAS SERPENTIN TAPON DE ACEITE	{58 D x 22 mm} 176 D X 28MM
V-6, 2.5 L	2004	T326 T327 K060612 31109	BANDA ARBOL DE LEVAS BANDA ARBOL DE LEVAS SERPENTIN TAPON DE ACEITE	{58 D x 22 mm} 176 D X 28MM
V-6, 2.5 L	2003	T326 T327 K060612 31109	BANDA ARBOL DE LEVAS BANDA ARBOL DE LEVAS SERPENTIN TAPON DE ACEITE	{58 D x 22 mm} 176 D X 28MM
V-6, 2.5 L	2002	T326 T327 K060612 31109	BANDA ARBOL DE LEVAS BANDA ARBOL DE LEVAS SERPENTIN TAPON DE ACEITE	{58 D x 22 mm} 176 D X 28MM

**AVIATOR**

V-8, 4.6 L	2005	36157 38001 38006 K061000 31109 31828 31830 31406 38274 33238	POLEA POLEA POLEA DEL TENSOR SERPENTIN TAPON DE ACEITE TAPON DE GASOLINA TAPON DE GASOLINA TAPONES DE RADIADOR TENSOR TERMOSTATOS	CON LLAVE 16 LBS. 180°
V-8, 4.6 L	2004	38001 36157 38006 K061000 31109 31828 31830 31406 38274 33238	POLEA POLEA POLEA DEL TENSOR SERPENTIN TAPON DE ACEITE TAPON DE GASOLINA TAPON DE GASOLINA TAPONES DE RADIADOR TENSOR TERMOSTATOS	CON LLAVE 16 LBS. 180°
V-8, 4.6 L	2003	38001 36157 38006 K061000 31109 31828 31830 31406 38274 33238	POLEA POLEA POLEA DEL TENSOR SERPENTIN TAPON DE ACEITE TAPON DE GASOLINA TAPON DE GASOLINA TAPONES DE RADIADOR TENSOR TERMOSTATOS	CON LLAVE 16 LBS. 180°

**RANGE ROVER**

V-8, 4.4 L	2008	DK080534 31275 31406	SERPENTIN TAPON DE ACEITE TAPONES DE RADIADOR	16 LBS.
V-8, 4.4 L	2007	DK080534 31275 31406	SERPENTIN TAPON DE ACEITE TAPONES DE RADIADOR	16 LBS.
V-8, 4.4 L	2006	DK080534 31275 31406	SERPENTIN TAPON DE ACEITE TAPONES DE RADIADOR	16 LBS.
V-8, 4.4 L	2005	K070644 K050396 31282 31332 31332	SERPENTIN SERPENTIN TAPON DE ACEITE TAPON DE RADIADOR TAPONES DE RADIADOR	ALT. (30 lbs) Sin Palanca 30 LBS.
V-8, 4.4 L	2004	K070644 K050396 31282 31332	SERPENTIN SERPENTIN TAPON DE ACEITE TAPONES DE RADIADOR	ALT. C/AA 30 LBS.
V-8, 4.4 L	2003	K070644 K050396 31282 31332	SERPENTIN SERPENTIN TAPON DE ACEITE TAPONES DE RADIADOR	ALT. C/AA 30 LBS.
V-8, 4.6 L	2002	CHARTER 1 K070916 38245	MANG. INF. SERPENTIN TENSOR MICRO-V	RAD A TERMOSTATO
V-8, 4.6 L	2001	CHARTER 1 K070916 38245	MANG. INF. SERPENTIN TENSOR MICRO-V	RAD A TERMOSTATO
V-8, 4.0 L	2000	CHARTER 1 K070916 38245	MANG. INF. SERPENTIN TENSOR MICRO-V	RAD A TERMOSTATO
V-8, 4.6 L	2000	CHARTER 1 K070916 31331 38245	MANG. INF. SERPENTIN TAPON DE RADIADOR TENSOR MICRO-V	RAD A TERMOSTATO (20 lbs) Sin palanca
V-8, 4.0 L	1999	CHARTER 1 K070916 31615 31331 38245	MANG. INF. SERPENTIN TAPON DE GASOLINA TAPON DE RADIADOR TENSOR MICRO-V	RAD A TERMOSTATO SIN LLAVE C/CONT. DE EMIS (20 lbs) Sin palanca
V-8, 4.6 L	1999	CHARTER 1 K070916 31734 31331 38245	MANG. INF. SERPENTIN TAPON DE GASOLINA TAPON DE RADIADOR TENSOR MICRO-V	RAD A TERMOSTATO CON LLAVE C/CONT. DE EMIS (20 lbs) Sin palanca
V-8, 4.0 L	1998	31615 31734 38245	TAPON DE GASOLINA TAPON DE GASOLINA TENSOR MICRO-V	SIN LLAVE C/CONT. DE EMIS CON LLAVE C/CONT. DE EMIS
V-8, 4.6 L	1998	31734 31615 38245	TAPON DE GASOLINA TAPON DE GASOLINA TENSOR MICRO-V	CON LLAVE C/CONT. DE EMIS SIN LLAVE C/CONT. DE EMIS

**CONTINENTAL**

V-8, 4.6 L	2002	19000 91831 22245 22244 38006 K060755 31109 31830 31406 38251 33029	CALEF. A MULTIPLE EDH MANGUERA INF. MANGUERA SUP. POLEA SERPENTIN TAPON DE ACEITE TAPON DE GASOLINA TAPON DE RADIADOR TENSOR MICRO-V TERMOSTATO	PRES. DESDE LA BOMBA     SIN LLAVE REGULAR (16 lbs) Sin Palanca 195°F
V-8, 4.6 L	2001	19000 91831 22245 22244 38006 K060755 31109 31830 31406 38251 33029	CALEF. A MULTIPLE EDH MANGUERA INF. MANGUERA SUP. POLEA SERPENTIN TAPON DE ACEITE TAPON DE GASOLINA TAPON DE RADIADOR TENSOR MICRO-V TERMOSTATO	PRES. DESDE LA BOMBA     SIN LLAVE REGULAR (16 lbs) Sin Palanca 195°F
V-8, 4.6 L	2000	19000 91831 22245 22244 38006 K060755 31109 31830 31406 38251 33029	CALEF. A MULTIPLE EDH MANGUERA INF. MANGUERA SUP. POLEA SERPENTIN TAPON DE ACEITE TAPON DE GASOLINA TAPON DE RADIADOR TENSOR MICRO-V TERMOSTATO	PRES. DESDE LA BOMBA     SIN LLAVE REGULAR (16 lbs) Sin Palanca 195°F
V-8, 4.6 L	1999	19000 91831	CALEF. A MULTIPLE EDH	PRES. DESDE LA BOMBA

V-8, 4.6 L	1999	22245 22244 38006 K060755 31109 31830 31406 38251 33029	MANGUERA INF. MANGUERA SUP. POLEA LOCA SERPENTIN TAPON DE ACEITE TAPON DE GASOLINA TAPON DE RADIADOR TENSOR MICRO-V TERMOSTATO	SIN LLAVE REGULAR (16 lbs) Sin Palanca  195°F
V-8, 4.6 L	1998	91831 19000 22245 22244 38006 K060755 31109 31830 31406 38251 33029	EDH MANG. CALEF. A MULTIPLE MANGUERA INF. MANGUERA SUP. POLEA LOCA SERPENTIN TAPON DE ACEITE TAPON DE GASOLINA TAPON DE RADIADOR TENSOR MICRO-V TERMOSTATO	PRES. DESDE LA BOMBA CORTAR A MEDIDA  SIN LLAVE REGULAR (16 lbs) Sin Palanca  195°F
V-8, 4.6 L	1997	BDH-6313 91831 19000 22245 22244 38006 31109 31830 31406 38251 33029	BOMBA DE DIR. HIDR. EDH MANG. CALEF. A MULTIPLE MANGUERA INF. MANGUERA SUP. POLEA LOCA TAPON DE ACEITE TAPON DE GASOLINA TAPON DE RADIADOR TENSOR MICRO-V TERMOSTATO	PRES. DESDE LA BOMBA CORTAR A MEDIDA  SIN LLAVE REGULAR (16 lbs) Sin Palanca  195°F

V-6, 3.0 L	2001	19754 92114 22510 22509 38001 K061080 31275 31830 31406 38279 33248	VALV. DEL CALEF. A B.A. AUX. EDH MANG. SUP. MANGUERA INF. POLEA LOCA SERPENTIN TAPON DE ACEITE TAPON DE GASOLINA TAPON DE RADIADOR TENSOR MICRO-V TERMOSTATO	PRES. A LA CAJA DE DIR  S/Enf de Aceite  SIN LLAVE REGULAR (16 lbs) Sin Palanca  195°F
V-8, 3.9 L	2001	19030 18787 92113 22562 38001 K061058 31109 31830 31406 38279 33948 19285 19754	CALEF. A TUBO AL CALEF. MED CALEF. A TUBO AL CALEF. SUP EDH MANGUERA SUP. POLEA SERPENTIN TAPON DE ACEITE TAPON DE GASOLINA TAPON DE RADIADOR TENSOR MICRO-V TERMOSTATO	PRES. A LA CAJA DE DIR  PRES. A LA CAJA DE DIR S/Enf de Aceite  C/AA, C/DH  SIN LLAVE REGULAR (16 lbs) Sin Palanca  180°F
V-6, 3.0 L	2000	92114 22509 38001 K061098 31275 31830 31406 38279 33248 19030 18787 92113 22562 38001 K061058 31109 31830 31406 38279 19285 19754	EDH MANGUERA INF. POLEA SERPENTIN TAPON DE ACEITE TAPON DE GASOLINA TAPON DE RADIADOR TENSOR MICRO-V TERMOSTATO CALEF. A TUBO AL CALEF. MED CALEF. A TUBO AL CALEF. SUP EDH MANGUERA SUP. POLEA SERPENTIN TAPON DE ACEITE TAPON DE GASOLINA TAPON DE RADIADOR TENSOR MICRO-V VALV. CALEF. A TUBO CALEF.S VALV. DEL CALEF. A B.A. AUX.	PRES. A LA CAJA DE DIR S/Enf de Aceite  C/AA, C/DH  SIN LLAVE REGULAR (16 lbs) Sin Palanca  195°F  PRES. A LA CAJA DE DIR S/Enf de Aceite  C/AA, C/DH  SIN LLAVE REGULAR (16 lbs) Sin Palanca  195°F

**LS**

V-8, 3.9 L	2006	92115 K060910 31117 31841 31406 38279	EDH SERPENTIN TAPON DE ACEITE TAPON DE GASOLINA TAPON DE RADIADOR TENSOR MICRO-V	PRES. A LA CAJA DE DIR  SIN LLAVE REGULAR (16 lbs) Sin Palanca
V-8, 3.9 L	2005	92115 K060910 31117 31841 31406 38279	EDH SERPENTIN TAPON DE ACEITE TAPON DE GASOLINA TAPON DE RADIADOR TENSOR MICRO-V	PRES. A LA CAJA DE DIR  SIN LLAVE REGULAR (16 lbs) Sin Palanca
V-8, 3.9 L	2004	92115 K060910 31117 31830 31406 38279	EDH SERPENTIN TAPON DE ACEITE TAPON DE GASOLINA TAPON DE RADIADOR TENSOR MICRO-V	PRES. A LA CAJA DE DIR  SIN LLAVE REGULAR (16 lbs) Sin Palanca
V-8, 3.9 L	2003	92115 K060910 31109 31830 31406 38279	EDH SERPENTIN TAPON DE ACEITE TAPON DE GASOLINA TAPON DE RADIADOR TENSOR MICRO-V	PRES. A LA CAJA DE DIR  SIN LLAVE REGULAR (16 lbs) Sin Palanca
V-8, 3.9 L	2002	19806 28475 19030 18787 92114 24022 22562 38001 K061058 31109 31830 31406 38279 33948 28408 19807 19285	B.A. AUX. A TUBO-1 CALEF. A TUBO AL CALEF. INF. CALEF. A TUBO AL CALEF. MED CALEF. A TUBO AL CALEF. SUP EDH MANGUERA DE PASO MANGUERA SUP. POLEA SERPENTIN TAPON DE ACEITE TAPON DE GASOLINA TAPON DE RADIADOR TENSOR MICRO-V TERMOSTATO TERMOSTATO A TANQUE DE RI TUBO-1 A TERMOSTATO VALV. CALEF. A TUBO CALEF.S	PRES. A LA CAJA DE DIR  SIN LLAVE REGULAR (16 lbs) Sin Palanca  SIN LLAVE REGULAR (16 lbs) Sin Palanca  180°F

**MARK LT**

V-8, 5.4 L	2008	36157 38001 38006 K061031 K060840 31275 31841 31842 31406 38274 38329 33469	POLEA POLEA POLEA DEL TENSOR SERPENTIN SERPENTIN TAPON DE ACEITE TAPON DE GASOLINA TAPON DE GASOLINA TAPON DE RADIADOR TENSOR TENSOR TERMOSTATO	RANURADA LISA A.A. CON A.A. SIN A.A.  CON LLAVE 16 LIBRAS CON A.A. SIN A.A. 195 ° F
V-8, 5.4 L	2007	36157 38001 38006 K060840 K061031 31275 31842 31841 31406 38329 38274 33469	POLEA POLEA POLEA DEL TENSOR SERPENTIN SERPENTIN TAPON DE ACEITE TAPON DE GASOLINA TAPON DE GASOLINA TAPON DE RADIADOR TENSOR TENSOR TERMOSTATO	RANURADA LISA A.A. SIN A.A. CON A.A.  CON LLAVE 16 LIBRAS SIN A.A. CON A.A. 195 ° F

**MARK VIII**

V-8, 4.6 L	1998	91836	EDH	PRESION
------------	------	-------	-----	---------

V-8, 4.6 L	1998	22131 21974 22132 K060975 31109 31828 31406 38132 33029	MANGUERA INF. MANGUERA INF. MANGUERA SUP. SERPENTIN TAPON DE ACEITE TAPON DE GASOLINA TAPON DE RADIADOR TENSOR MICRO-V TERMOSTATO	CON LLAVE REGULAR (16 lbs) Sin Palanca  195°F PRESION
V-8, 4.6 L	1997	91836 21974 22131 22132 K060975 31109 31828 31406 38132 33029	EDH MANGUERA INF. MANGUERA INF. MANGUERA SUP. SERPENTIN TAPON DE ACEITE TAPON DE GASOLINA TAPON DE RADIADOR TENSOR MICRO-V TERMOSTATO	CON LLAVE REGULAR (16 lbs) Sin Palanca  195°F

V-8, 5.4 L	2007	38274 33469 K061015 31109 31841 31406 38274 K061015 K061020 31109 31841 31406 38274 K061015 31109 31841 31406 38274 K061015 31109 31841 31406 38274 38001 K061015 31109 31830 31406 38274 38001 38006 K061015 31109 31830 31406 38274 K061015 31109 31830 31406 38274 22539 35B 1/4" 35B 1/4" 38023 38022 K060984 35B 3/8" 31109 31830 31406 38133 38274 33469 35B 1/4" 22539 38023 38022 K080981 31109 31828 31406 38133 33469 19219 22513 353920(802) EDH 22295 22297 22302 22539 38023 38022 K080981 31109 31830 31406 38133 33469 19219 22540 19193 22513 353920(802) EDH 22295	TENSOR TERMOSTATOS SERPENTIN TAPON DE ACEITE TAPON DE GASOLINA TAPON DE RADIADOR TENSOR MICRO-V SERPENTIN SERPENTIN TAPON DE ACEITE TAPON DE GASOLINA TAPON DE RADIADOR TENSOR MICRO-V SERPENTIN TAPON DE ACEITE TAPON DE GASOLINA TAPON DE RADIADOR TENSOR MICRO-V POLEA SERPENTIN TAPON DE ACEITE TAPON DE GASOLINA TAPON DE RADIADOR TENSOR MICRO-V POLEA SERPENTIN TAPON DE ACEITE TAPON DE GASOLINA TAPON DE RADIADOR TENSOR MICRO-V MANGUERA SUP. MULT. PCV CALEF. A TERMOST PCV VALV. A MULT. PCV CALEF POLEA DEL TENSOR POLEA LOCA SERPENTIN TANQUE DE RECUP. A RADIAD TAPON DE ACEITE TAPON DE GASOLINA TAPON DE RADIADOR TENSOR MICRO-V TENSOR MICRO-V TERMOSTATO TUBO-1 A VALV. CALEF. MANGUERA SUP. POLEA DEL TENSOR POLEA LOCA SERPENTIN TAPON DE ACEITE TAPON DE GASOLINA TAPON DE RADIADOR TENSOR MICRO-V TERMOSTATO CALEF. A MULTIPLE CALEF. A TUBO-1 EDH MANGUERA INF. MANGUERA INF. MANGUERA SUP. MANGUERA SUP. POLEA DEL TENSOR POLEA LOCA SERPENTIN TAPON DE ACEITE TAPON DE GASOLINA TAPON DE RADIADOR TENSOR MICRO-V TERMOSTATO CALEF. A MULTIPLE CALEF. A TUBO-1 CALEF. A MULTIPLE CALEF. A TUBO-1 CALEF. A TUBO-1 EDH MANGUERA INF.	195°  SIN LLAVE REGULAR (16 lbs) Sin Palanca  DE 5 DIC. 2005 Y NUEVAS SIN LLAVE REGULAR (16 lbs) Sin Palanca  SIN LLAVE REGULAR (16 lbs) Sin Palanca  SIN LLAVE REGULAR (16 lbs) Sin Palanca  LISO SIN LLAVE REGULAR (16 lbs) Sin Palanca  SIN LLAVE REGULAR (16 lbs) Sin Palanca  SIN LLAVE REGULAR (16 lbs) Sin Palanca  195°F  C/AA, C/DH C/AA, C/DH C/AA, C/DH DOHC C/AA, C/DH SIN LLAVE REGULAR (16 lbs) Sin Palanca  195°F SOHC; S/Calef. Auxiliar; Re-us SOHC; C/Calef. Auxiliar PRESION C/AA, C/DH C/AA, C/DH DOHC C/AA, C/DH SIN LLAVE REGULAR (16 lbs) Sin Palanca  195°F SOHC; S/Calef. Auxiliar; Re-us DOHC; C/Calef. Auxiliar; Re-us SOHC; S/Calef. Auxiliar SOHC; C/Calef. Auxiliar PRESION C/AA, C/DH

**MKX**

V-6, 3.5 L	2009	K040352SF 91030 K060448	D.H. STRECH FIT HERRAMIENTA INST. STRECH F SERPENTIN	
V-6, 3.5 L	2008	K040352SF 91030 K060448 31275 31842 31841 31406 33238	D.H. STRECH FIT HERRAMIENTA INST. STRECH F SERPENTIN TAPON DE ACEITE TAPON DE GASOLINA TAPON DE GASOLINA TAPON DE RADIADOR TERMOSTATO	CON LLAVE  16 LIBRAS 180 ° F
V-6, 3.5 L	2007	K040352SF 91030 K060448 31275 31842 31841 31406 33238	D.H. STRECH FIT HERRAMIENTA INST. STRECH F SERPENTIN TAPON DE ACEITE TAPON DE GASOLINA TAPON DE GASOLINA TAPON DE RADIADOR TERMOSTATO	CON LLAVE  16 LIBRAS 180 ° F

**MKZ**

V-6, 3.5 L	2009	K040352SF 91030 K060448	D.H. STRECH FIT HERRAMIENTA INST. STRECH F SERPENTIN	
V-6, 3.5 L	2008	K040352SF 91030 K060448 31275 33238	D.H. STRECH FIT HERRAMIENTA INST. STRECH F SERPENTIN TAPON DE ACEITE TERMOSTATO	180 ° F
V-6, 3.5 L	2007	K040352SF 91030 K060448 31275 33238	D.H. STRECH FIT HERRAMIENTA INST. STRECH F SERPENTIN TAPON DE ACEITE TERMOSTATO	180 ° F

**NAVIGATOR**

V-8, 5.4 L	2009	38001 36157 38006 K061031 31841 31842 31336 38274 33469	POLEA POLEA POLEA DEL TENSOR SERPENTIN TAPON DE GASOLINA TAPON DE GASOLINA TAPONES DE RADIADOR TENSOR TERMOSTATOS	LISA RANURADA A.A.  CON LLAVE 16 LBS. 195°
V-8, 5.4 L	2008	36157 38001 38006 K061031 31842 31841 31336	POLEA POLEA POLEA DEL TENSOR SERPENTIN TAPON DE GASOLINA TAPON DE GASOLINA TAPONES DE RADIADOR	RANURADA LISA A.A.  CON LLAVE 16 LBS.



V-8, 5.4 L	1999	22297 22302 22539 38023 38022 K080981 31109 31828 31406 38133 33469	MANGUERA INF. MANGUERA SUP. MANGUERA SUP. POLEA DEL TENSOR POLEA LOCA SERPENTIN TAPON DE ACEITE TAPON DE GASOLINA TAPON DE RADIADOR TENSOR MICRO-V TERMOSTATO	C/AA, C/DH C/AA, C/DH DOHC  C/AA, C/DH  CON LLAVE REGULAR (16 lbs) Sin Palanca  195°F PRESION
V-8, 5.4 L	1998	353920(802) 38023 38022 K080981 31109 31828 31406 38133 33469	EDH POLEA DEL TENSOR POLEA LOCA SERPENTIN TAPON DE ACEITE TAPON DE GASOLINA TAPON DE RADIADOR TENSOR MICRO-V TERMOSTATO	C/AA, C/DH  CON LLAVE REGULAR (16 lbs) Sin Palanca  195°F

V-8, 4.6 L	2000	31830 31406 38189 33189 19727 18070 361330(802) 22809 22388 38006 K060915 31109 31830 31406 38189 33189 19727 18070 361330(802) 22809 22388 38006 K060975 31109 31828 31406 38132 33189	TAPON DE GASOLINA TAPON DE RADIADOR TENSOR MICRO-V TERMOSTATO CALEF. A MULTIPLE CALEF. A TUBO-1 EDH MANG. SUP. MANGUERA INF. POLEA SERPENTIN TAPON DE ACEITE TAPON DE GASOLINA TAPON DE RADIADOR TENSOR MICRO-V TERMOSTATO CALEF. A MULTIPLE CALEF. A TUBO-1 EDH MANG. SUP. MANGUERA INF. POLEA LOCA SERPENTIN TAPON DE ACEITE TAPON DE GASOLINA TAPON DE RADIADOR TENSOR MICRO-V TERMOSTATO	SIN LLAVE REGULAR (16 lbs) Sin Palanca  195°F  PRESION  PRESION  C/AA, C/DH  CON LLAVE REGULAR (16 lbs) Sin Palanca  195°F PRESION  C/AA, C/DH  SIN LLAVE REGULAR (16 lbs) Sin Palanca  195°F
V-8, 4.6 L	1998	361330(802) 22809 22388 38006 K060975 31109 31830 31406 38132 33189 21927 22393 38006 K060975 31109 38132	EDH MANG. SUP. MANGUERA INF. POLEA LOCA SERPENTIN TAPON DE ACEITE TAPON DE GASOLINA TAPON DE RADIADOR TENSOR MICRO-V TERMOSTATO MANGUERA INF. MANGUERA SUP. POLEA LOCA SERPENTIN TAPON DE ACEITE TENSOR MICRO-V	V-8, 4.6 L  PRESION  C/AA, C/DH  SIN LLAVE REGULAR (16 lbs) Sin Palanca  195°F

## TOWN CAR

V-8, 4.6 L	2006	92100 38006 36100 K060923 K060908 31117 31841 31406 38189	EDH POLEA POLEA SERPENTIN SERPENTIN TAPON DE ACEITE TAPON DE GASOLINA TAPON DE RADIADOR TENSOR MICRO-V	PRESION LISA  SIN LLAVE REGULAR (16 lbs) Sin Palanca
V-8, 4.6 L	2005	92100 K060908 31117 31841 31406	EDH SERPENTIN TAPON DE ACEITE TAPON DE GASOLINA TAPON DE RADIADOR	PRESION  SIN LLAVE REGULAR (16 lbs) Sin Palanca
V-8, 4.6 L	2004	92100 36100 K060908 31275 31828 31406 38189 33469	EDH POLEA SERPENTIN TAPON DE ACEITE TAPON DE GASOLINA TAPON DE RADIADOR TENSOR MICRO-V TERMOSTATO	PRESION CON CANALES  CON LLAVE REGULAR (16 lbs) Sin Palanca  195°F
V-8, 4.6 L	2003	22994 38006 K060908 31275 31830 31406 38189 33189	MANG. SUP. POLEA TENSORA SERPENTIN TAPON DE ACEITE TAPON DE GASOLINA TAPON DE RADIADOR TENSOR MICRO-V TERMOSTATO	SIN LLAVE REGULAR (16 lbs) Sin Palanca  195°F
V-8, 4.6 L	2002	30T 5/8" 19727 18070 361330(802) 22809 22388 22392 K060919 35B 3/8" 31109 31828 31406 38189 33189	B.A. A TUBO CALEF. A MULTIPLE CALEF. A TUBO-1 EDH MANG. SUP. MANGUERA INF. MANGUERA SUP. SERPENTIN TANQUE DE RECUP. A RADIAD TAPON DE ACEITE TAPON DE GASOLINA TAPON DE RADIADOR TENSOR MICRO-V TERMOSTATO	PRESION  S/Enfriador de aceite  CON LLAVE REGULAR (16 lbs) Sin Palanca  195°F
V-8, 4.6 L	2001	19727 18070 361330(802) 22809 22388 36100 K060915 31109	CALEF. A MULTIPLE CALEF. A TUBO-1 EDH MANG. SUP. MANGUERA INF. POLEA SERPENTIN TAPON DE ACEITE	PRESION  CON CANALES

## MAZDA

### CX-7

4 CIL, 2.3 L	2008	36263 K060900 31117 31836 31838 31551 T39074 34046	POLEA SERPENTIN TAPON DE ACEITE TAPON DE GASOLINA TAPON DE GASOLINA TAPONES DE RADIADOR TENSOR TERMOSTATOS	CON TURBO  CON LLAVE  20 LIBRAS  180°
4 CIL, 2.3 L	2007	36263 K060900 31117 31838 31836 31551 T39074 34046	POLEA SERPENTIN TAPON DE ACEITE TAPON DE GASOLINA TAPON DE GASOLINA TAPONES DE RADIADOR TENSOR TERMOSTATOS	CON TURBO  CON LLAVE 20 LIBRAS  180°
4 CIL, 2.3 L	2006	36263 K060900 31117 31836 31838 31551 T39074 34046	POLEA SERPENTIN TAPON DE ACEITE TAPON DE GASOLINA TAPON DE GASOLINA TAPONES DE RADIADOR TENSOR TERMOSTATOS	CON TURBO  CON LLAVE  20 LBS.  180°

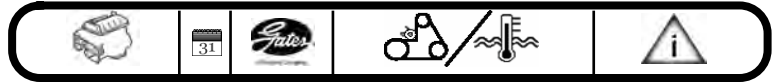

<b>CX-9</b>			
V-6, 3.7 L	2008	K040352SF 91030 K060448 31117 31838 31836 31551	D.H. STRECH FIT HERRAMIENTA INST. STRECH F SERPENTIN TAPON DE ACEITE TAPON DE GASOLINA TAPON DE GASOLINA TAPONES DE RADIADOR
			ALT. Y A.A. 4 CIL, 2.0 L
V-6, 3.7 L	2007	K040352SF 91030 K060448 31117 31836 31838 31551	D.H. STRECH FIT HERRAMIENTA INST. STRECH F SERPENTIN TAPON DE ACEITE TAPON DE GASOLINA TAPON DE GASOLINA TAPONES DE RADIADOR
			ALT. Y A.A. CON LLAVE 20 LIBRAS 4 CIL, 2.3 L

31857 38357 38408 34046	TAPON DE GASOLINA TENSOR TENSOR TERMOSTATOS	SIN LLAVE CON TRANSMISION AUTOMA CON TURBO 180 ° F
K050275 K050264SF 91030 23365 K060514 31295 31857 38357 34046 34046	A.A. A.A. STRECH FIT HERRAMIENTA INST. STRECH F MANGUERA SUP. SERPENTIN TAPON DE ACEITE TAPON DE GASOLINA TENSOR TERMOSTATOS TERMOSTATOS	VIN 040901 VIN 040901 >OEM.LFY215SAJ VIN 040901 >OEM.LFY115SAJ
K050272SF K050264SF 91030 23365 23365 K060910 K060520 31295 31857 38357 38408 38408 34046	A.A. STRECH FIT A.A. STRECH FIT HERRAMIENTA INST. STRECH F MANGUERA INF. MANGUERA SUP. SERPENTIN SERPENTIN TAPON DE ACEITE TAPON DE GASOLINA TENSOR TENSOR TENSOR MICRO-V TERMOSTATOS	SIN LLAVE CON TRANSMISION AUTOMA CON TURBO 180 ° F

<b>MAZDA 3</b>			
4 CIL, 2.3 L	2010	38006 K060886 38409	POLEA SERPENTIN TENSOR
4 CIL, 2.0 L	2009	K060514 31295 31857 31856 31549 34046	SERPENTIN TAPON DE ACEITE TAPON DE GASOLINA TAPON DE GASOLINA TAPONES DE RADIADOR TERMOSTATOS
			CON LLAVE 21 LBS. 180° VIN 040901 >OEM.LFY215SAJ VIN 040901 >OEM.LFY115SAJ
4 CIL, 2.3 L	2009	K050272SF K050264SF 91030 23365 23365 K050275 K050264SF 91030 23365 K060514 31857 31856 31295 38357 34046 34046	A.A. STRECH FIT A.A. STRECH FIT HERRAMIENTA INST. STRECH F MANGUERA INF. MANGUERA SUP. A.A. HERRAMIENTA INST. STRECH F MANGUERA SUP. SERPENTIN TAPON DE GASOLINA TAPON DE GASOLINA TAPONES DE RADIADOR TENSOR TERMOSTATOS TERMOSTATOS
			VIN 040901 ACCESORIOS CON LLAVE 180° 180 ° F
4 CIL, 2.0 L	2008	K050264SF K050272SF 91030 23365 23365 K060910 K060520 31857 31856 31295 38357 38408 34046	A.A. STRECH FIT A.A. STRECH FIT HERRAMIENTA INST. STRECH F MANGUERA INF. MANGUERA SUP. SERPENTIN SERPENTIN TAPON DE GASOLINA TAPON DE GASOLINA TAPONES DE RADIADOR TENSOR TENSOR TERMOSTATOS
			VIN 040901 SIN TURBO RADIADOR AL TE SIN TURBO VIN 040901 4 CIL, 2.3 L ACCESORIOS CON LLAVE CON TRANSMISION AUTOMA CON TURBO 180 ° F V-6, 3.0 L
4 CIL, 2.3 L	2008	K050264SF K050272SF 91030 23365 23365 K060910 K060520 31857 31856 31295 38357 38408 34046	A.A. STRECH FIT A.A. STRECH FIT HERRAMIENTA INST. STRECH F MANGUERA INF. MANGUERA SUP. SERPENTIN SERPENTIN TAPON DE GASOLINA TAPON DE GASOLINA TAPONES DE RADIADOR TENSOR TENSOR TERMOSTATOS
			VIN 040901 >OEM.LFY115SAJ VIN 040901 >OEM.LFY215SAJ SIN TURBO RADIADOR AL TE SIN TURBO CON TURBO CON LLAVE CON TRANSMISION AUTOMA CON TURBO 180 ° F V-6, 3.0 L
4 CIL, 2.0 L	2007	K050275 K050264SF 91030 23365 K060514 31295 31857 38357 34046 34046	A.A. A.A. STRECH FIT HERRAMIENTA INST. STRECH F MANGUERA SUP. SERPENTIN TAPON DE ACEITE TAPON DE GASOLINA TENSOR TERMOSTATOS
			VIN 040901 SIN LLAVE 4 CIL, 2.3 L 180° 180 ° F
4 CIL, 2.3 L	2007	K050264SF K050272SF 91030 23365 K060910 K060520 31295 31857 31856 31295 38357 38408 34046	A.A. STRECH FIT A.A. STRECH FIT HERRAMIENTA INST. STRECH F MANGUERA INF. MANGUERA SUP. SERPENTIN SERPENTIN TAPON DE GASOLINA TAPON DE GASOLINA TAPONES DE RADIADOR TENSOR TENSOR TERMOSTATOS
			VIN 040901 >OEM.LFY115SAJ VIN 040901 >OEM.LFY215SAJ SIN TURBO RADIADOR AL TE SIN TURBO CON TURBO CON LLAVE CON TRANSMISION AUTOMA CON TURBO 180 ° F V-6, 3.0 L

<b>MAZDA 5</b>			
4 CIL, 2.3 L	2007	K060520 31295 31857 31412 38357 38357	SERPENTIN TAPON DE ACEITE TAPON DE GASOLINA TAPON DE RADIADOR TENSOR TENSOR
			SIN LLAVE (16 lbs) Sin Palanca CON TRANSMISION MANUAL CON TRANSMISION AUTOMA
4 CIL, 2.3 L	2006	K060520 31295 31857 31412 38357 38357	SERPENTIN TAPON DE ACEITE TAPON DE GASOLINA TAPON DE RADIADOR TENSOR TENSOR
			SIN LLAVE (16 lbs) Sin Palanca CON TRANSMISION MANUAL CON TRANSMISION AUTOMA

<b>MAZDA 6</b>			
4 CIL, 2.3 L	2008	19335 19336 22834 22837 38006 K060886 31295 31856 31857 31551 38409 34046	MANGUERA CALEFACCION MANGUERA CALEFACCION MANGUERA INF. MANGUERA SUP. POLEA SERPENTIN TAPON DE ACEITE TAPON DE GASOLINA TAPON DE GASOLINA TAPONES DE RADIADOR TENSOR TERMOSTATOS
			ALTA BAJA CON LLAVE 20 LBS. 180°
4 CIL, 2.0 L	2008	K030195SF 91030 K060825 31295 31836 31838 31532 33248 22834 22837 38008 K060910 K060883 31295 31838 31551 38409 38408	D.H. STRECH FIT HERRAMIENTA INST. STRECH F SERPENTIN TAPON DE ACEITE TAPON DE GASOLINA TAPON DE GASOLINA TAPONES DE RADIADOR TERMOSTATOS MANG. INF. MANG. SUP. POLEA SERPENTIN SERPENTIN TAPON DE ACEITE TAPON DE GASOLINA TAPON DE RADIADOR TENSOR TENSOR
			VIN 040901 SIN LLAVE 4 CIL, 2.3 L 180° 180 ° F V-6, 3.0 L CON TURBO CON TURBO 188° C/TURBO C/TURBO S/TURBO SIN LLAVE REGULAR (14 lbs) Sin Palanca SIN TURBO CON TURBO
4 CIL, 2.3 L	2007	22838	MANG. DE PASO

V-6, 3.0 L	2007	22835 22836 K060825 31838 31532 33509	MANG. INF. MANG. SUP. SERPENTIN TAPON DE GASOLINA TAPON DE RADIADOR TERMOSTATO	SIN LLAVE REGULAR (15 lbs) Sin palanca 195°F
4 CIL, 2.3 L	2006	22834 22837 38008 K060910 K060883 31295 31838 31551 38409 38408	MANG. INF. MANG. SUP. POLEA SERPENTIN SERPENTIN TAPON DE ACEITE TAPON DE GASOLINA TAPON DE RADIADOR TENSOR TENSOR	C/TURBO C/TURBO S/TURBO  SIN LLAVE REGULAR (14 lbs) Sin Palanca SIN TURBO CON TURBO
V-6, 3.0 L	2006	22838 22835 22836 K060825 31838 31532 33509	MANG. DE PASO MANG. INF. MANG. SUP. SERPENTIN TAPON DE GASOLINA TAPON DE RADIADOR TERMOSTATO	SIN LLAVE REGULAR (15 lbs) Sin palanca 195°F

**MX-5 MIATA**

4 CIL, 2.0 L	2007	38008 K060854 K060882 31295 31838 31336	POLEA SERPENTIN SERPENTIN TAPON DE ACEITE TAPON DE GASOLINA TAPON DE RADIADOR	S/AA C/AA  SIN LLAVE REGULAR (16 lbs) Sin Palanca
4 CIL, 2.0 L	2006	38008 K060854 K060882 31295 31838 31336	POLEA SERPENTIN SERPENTIN TAPON DE ACEITE TAPON DE GASOLINA TAPON DE RADIADOR	S/AA C/AA  SIN LLAVE REGULAR (16 lbs) Sin Palanca

**MERCEDES BENZ**

**C230**

4 CIL, 2.3 L	2000	K060523 K060739 22585 22584 31100 31522	ALT. D.H. MANGUERA INF. MANGUERA SUP. TAPON DE ACEITE TAPON DE RADIADOR	(20 lbs) Sin Palanca
4 CIL, 2.3 L	1999	K060523 K060739 22233 22585 22234 22584 31100 31522	ALT. D.H. MANGUERA INF. MANGUERA INF. MANGUERA SUP. MANGUERA SUP. TAPON DE ACEITE TAPON DE RADIADOR	C/AA, C/DH  C/AA, C/DH
4 CIL, 2.3 L	1998	K060849 31100 31522	SERPENTIN TAPON DE ACEITE TAPON DE RADIADOR	(20 lbs) Sin Palanca
4 CIL, 2.3 L	1997	31100 31522	TAPON DE ACEITE TAPON DE RADIADOR	(20 lbs) Sin Palanca

**C240**

V-6, 2.6 L	2005	38082 K060942 38174	POLEA SERPENTIN TENSOR MICRO-V	
V-6, 2.6 L	2004	38082 K060942 38174	POLEA SERPENTIN TENSOR MICRO-V	
V-6, 2.6 L	2003	38082 K060942 38174	POLEA SERPENTIN TENSOR MICRO-V	

V-6, 2.6 L	2002	38082 K060942 38174	POLEA SERPENTIN TENSOR MICRO-V	
V-6, 2.6 L	2001	38082 K060942 38174	POLEA SERPENTIN TENSOR MICRO-V	

**C280**

V-6, 2.8 L	2000	22575 22574 38082 K060942 31100 38174	MANG. INF. MANG. SUP. POLEA SERPENTIN TAPON DE ACEITE TENSOR MICRO-V	
V-6, 2.8 L	1999	22575 22574 38082 K060942 31100 38174	MANG. INF. MANG. SUP. POLEA SERPENTIN TAPON DE ACEITE TENSOR MICRO-V	
V-6, 2.8 L	1998	22587 22279 38082 K060942 31100 38174	MANG. INF. MANG. SUP. POLEA SERPENTIN TAPON DE ACEITE TENSOR MICRO-V	
V-6, 2.8 L	1997	31100	TAPON DE ACEITE	

**C320**

V-6, 3.2 L	2005	38082 K060942 38174	POLEA SERPENTIN TENSOR MICRO-V	
V-6, 3.2 L	2004	38082 K060942 38174	POLEA SERPENTIN TENSOR MICRO-V	
V-6, 3.2 L	2003	38082 K060942 38174	POLEA SERPENTIN TENSOR MICRO-V	
V-6, 3.2 L	2002	38082 K060942 38174	POLEA SERPENTIN TENSOR MICRO-V	
V-6, 3.2 L	2001	38082 K060942 38174	POLEA SERPENTIN TENSOR MICRO-V	

**C43**

V-8, 4.3 L	2000	38082 K060942 38174	POLEA SERPENTIN TENSOR MICRO-V	
V-8, 4.3 L	1999	38082 K060942 38174	POLEA SERPENTIN TENSOR MICRO-V	

**CL500**

V-8, 5.0 L	2005	38082 K060938 38174	POLEA SERPENTIN TENSOR MICRO-V	
V-8, 5.0 L	2004	38082 K060938 38174	POLEA SERPENTIN TENSOR MICRO-V	
V-8, 5.0 L	2003	38082 K060938 38174	POLEA SERPENTIN TENSOR MICRO-V	
V-8, 5.0 L	2002	38082 38174	POLEA TENSOR MICRO-V	
V-8, 5.0 L	2001	38082 K060942 38174	POLEA SERPENTIN TENSOR MICRO-V	
V-8, 5.0 L	2000	38082 K060942 38174	POLEA SERPENTIN TENSOR MICRO-V	
V-8, 5.0 L	1999	22595	MANGUERA INF.	

V-8, 5.0 L	1999	K060942	SERPENTIN	
V-8, 5.0 L	1998	K060988	SERPENTIN	

V-8, 4.3 L	2002	38174	SENSOR MICRO-V	
		38082	POLEA	
		K060942	SERPENTIN	
V-8, 4.3 L	2001	38174	SENSOR MICRO-V	
		38082	POLEA	
		K060942	SERPENTIN	
V-8, 4.3 L	2000	38174	SENSOR MICRO-V	
		38082	POLEA	
		K060942	SERPENTIN	
V-8, 4.3 L	1999	38174	SENSOR MICRO-V	
		K060942	SERPENTIN	

**CL55**

V-8, 5.5 L	2006	38082	POLEA	
		K060938	SERPENTIN	
		38174	SENSOR MICRO-V	
V-8, 5.5 L	2005	38082	POLEA	
		K060938	SERPENTIN	
		38174	SENSOR MICRO-V	
V-8, 5.5 L	2004	38082	POLEA	
		K060938	SERPENTIN	
		38174	SENSOR MICRO-V	
V-8, 5.5 L	2003	38082	POLEA	
		K060938	SERPENTIN	
		38174	SENSOR MICRO-V	
V-8, 5.5 L	2002	38082	POLEA	
		K060938	SERPENTIN	
		38174	SENSOR MICRO-V	
V-8, 5.5 L	2001	38082	POLEA	
		K060938	SERPENTIN	
		K060942	SERPENTIN	AGOSTO 24 2001
		38174	SENSOR MICRO-V	

**CLK500**

V-8, 5.0 L	2005	38082	POLEA	
		38174	SENSOR MICRO-V	
V-8, 5.0 L	2004	38082	POLEA	
		38174	SENSOR MICRO-V	
V-8, 5.0 L	2003	38082	POLEA	
		38174	SENSOR MICRO-V	

**CLK55**

V-8, 5.5 L	2006	K060942	SERPENTIN	
		K060938	SERPENTIN	AGOSTO 24 2001
		31281	TAPON DE ACEITE	
		31847	TAPON DE GASOLINA	
		31540	TAPON DE RADIADOR	(15 lbs) Sin Palanca
		38174	SENSOR MICRO-V	
		33930	TERMOSTATO	195°F
V-8, 5.5 L	2005	38082	POLEA	
		K060938	SERPENTIN	AGOSTO 24 2001
		K060942	SERPENTIN	
		31281	TAPON DE ACEITE	
		31847	TAPON DE GASOLINA	
		31540	TAPON DE RADIADOR	(15 lbs) Sin Palanca
		38174	SENSOR MICRO-V	
		33930	TERMOSTATO	195°F
V-8, 5.5 L	2004	38082	POLEA	
		K060938	SERPENTIN	AGOSTO 24 2001
		K060942	SERPENTIN	
		31281	TAPON DE ACEITE	
		31847	TAPON DE GASOLINA	
		31540	TAPON DE RADIADOR	(15 lbs) Sin Palanca
		38174	SENSOR MICRO-V	
		33930	TERMOSTATO	195°F
V-8, 5.5 L	2003	38082	POLEA	
		K060938	SERPENTIN	AGOSTO 24 2001
		K060942	SERPENTIN	
		31281	TAPON DE ACEITE	
		31847	TAPON DE GASOLINA	
		31540	TAPON DE RADIADOR	(15 lbs) Sin Palanca
		38174	SENSOR MICRO-V	
		33930	TERMOSTATO	195°F
V-8, 5.5 L	2002	38082	POLEA	
		K060938	SERPENTIN	AGOSTO 24 2001
		K060942	SERPENTIN	
		31281	TAPON DE ACEITE	
		31847	TAPON DE GASOLINA	
		31540	TAPON DE RADIADOR	(15 lbs) Sin Palanca
		38174	SENSOR MICRO-V	
		33930	TERMOSTATO	195°F
V-8, 5.5 L	2001	K060942	SERPENTIN	AGOSTO 24 2001
		K060938	SERPENTIN	
		31281	TAPON DE ACEITE	
		31847	TAPON DE GASOLINA	
		31540	TAPON DE RADIADOR	(15 lbs) Sin Palanca
		38174	SENSOR MICRO-V	
		33930	TERMOSTATO	195°F

**CL600**

V-12, 5.8 L	2001	K060923	SERPENTIN	
V-12, 6.0 L	1999	K061015	SERPENTIN	
V-12, 6.0 L	1998	K061020	SERPENTIN	

**CLK320**

V-6, 3.2 L	2005	18275	MANG. SUP.	T A TANQUE
		22573	MANG. SUP.	RADIADOR A T
		22574	MANG. SUP.	T" A MOTOR"
		38082	POLEA	
		K060942	SERPENTIN	
		38174	SENSOR MICRO-V	
V-6, 3.2 L	2004	18275	MANG. SUP.	T A TANQUE
		22573	MANG. SUP.	RADIADOR A T
		22574	MANG. SUP.	T" A MOTOR"
		38082	POLEA	
		K060942	SERPENTIN	
		38174	SENSOR MICRO-V	
V-6, 3.2 L	2003	18275	MANG. SUP.	T A TANQUE
		22573	MANG. SUP.	RADIADOR A T
		22574	MANG. SUP.	T" A MOTOR"
		38082	POLEA	
		K060942	SERPENTIN	
		38174	SENSOR MICRO-V	
V-6, 3.2 L	2002	18275	MANG. SUP.	T A TANQUE
		22573	MANG. SUP.	RADIADOR A T
		22574	MANG. SUP.	T" A MOTOR"
		38082	POLEA	
		K060942	SERPENTIN	
		38174	SENSOR MICRO-V	
V-6, 3.2 L	2001	18275	MANG. SUP.	T A TANQUE
		22573	MANG. SUP.	RADIADOR A T
		22574	MANG. SUP.	T" A MOTOR"
		38082	POLEA	
		K060942	SERPENTIN	
		38174	SENSOR MICRO-V	
V-6, 3.2 L	2000	K060942	SERPENTIN	
		22573	SUP. - RADIADOR A T	
		22574	SUP. - T A MOTOR	
		18275	SUP. - T A TANQUE	
V-6, 3.2 L	1999	K060942	SERPENTIN	
		22573	SUP. - RADIADOR A T	
		22574	SUP. - T A MOTOR	
		18275	SUP. - T A TANQUE	

**CLK430**

V-8, 4.3 L	2003	38082	POLEA	
		K060942	SERPENTIN	

**E320**

V-6, 3.2 L	2006	22577	MANG. INF.	
		22576	MANG. SUP.	
		38082	POLEA	
		K060938	SERPENTIN	



V-6, 3.2 L	2006	38174	TENSOR MICRO-V	
V-6, 3.2 L	2005	22577	MANG. INF.	
		22576	MANG. SUP.	
		38082	POLEA	
		K060938	SERPENTIN	
V-6, 3.2 L	2004	38174	TENSOR MICRO-V	
		22577	MANG. INF.	
		22576	MANG. SUP.	
		38082	POLEA	
		K060938	SERPENTIN	
V-6, 3.2 L	2003	38174	TENSOR MICRO-V	
		22577	MANG. INF.	
		22576	MANG. SUP.	
		38082	POLEA	
		K060938	SERPENTIN	
V-6, 3.2 L	2002	38174	TENSOR MICRO-V	
		22577	MANG. INF.	
		22576	MANG. SUP.	
		38082	POLEA	
		K060938	SERPENTIN	
V-6, 3.2 L	2001	38174	TENSOR MICRO-V	
		22577	MANG. INF.	
		22576	MANGUERA SUP.	
		38082	POLEA	
		K060942	SERPENTIN	
V-6, 3.2 L	2000	38174	TENSOR MICRO-V	
		22576	MANGUERA SUP.	
		K060942	SERPENTIN	
		31100	TAPON DE ACEITE	
		33518	TERMOSTATO	
V-6, 3.2 L	1999	22576	MANGUERA SUP.	
		K060942	SERPENTIN	
		31100	TAPON DE ACEITE	
V-6, 3.2 L	1998	K060942	SERPENTIN	
		31100	TAPON DE ACEITE	
V-6, 3.2 L	1997	31100	TAPON DE ACEITE	

180°F

**E430**

V-8, 4.3 L	2001	22578	MANG. SUP.	
		38082	POLEA	
		K060942	SERPENTIN	
		38174	TENSOR MICRO-V	
V-8, 4.3 L	2000	22579	MANG. INF.	
		22578	MANGUERA SUP.	
		K060942	SERPENTIN	
V-8, 4.3 L	1999	22579	MANG. INF.	
		22578	MANGUERA SUP.	
		K060942	SERPENTIN	

**E55**

V-8, 5.5 L	2002	38082	POLEA	
		38174	TENSOR MICRO-V	
V-8, 5.5 L	2001	38082	POLEA	
		K060942	SERPENTIN	
		38174	TENSOR MICRO-V	
V-8, 5.5 L	2000	K060942	SERPENTIN	
V-8, 5.5 L	1999	K060942	SERPENTIN	

**ML320**

V-6, 3.2 L	2003	38082	POLEA	
		K060942	SERPENTIN	
		38174	TENSOR MICRO-V	
V-6, 3.2 L	2002	38082	POLEA	
		K060942	SERPENTIN	
		38174	TENSOR MICRO-V	
V-6, 3.2 L	2001	22580	MANGUERA SUP.	
		38082	POLEA	
		K060942	SERPENTIN	
		38174	TENSOR MICRO-V	
V-6, 3.2 L	2000	22580	MANGUERA SUP.	
		K060942	SERPENTIN	
		31100	TAPON DE ACEITE	
		31780	TAPON DE GASOLINA	

CON LLAVE REGULAR



	1999	22580	MANGUERA SUP.	
		K060942	SERPENTIN	
		31100	TAPON DE ACEITE	
		31780	TAPON DE GASOLINA	CON LLAVE REGULAR

**ML430**

V-8, 4.3 L	2001	22582	MANGUERA SUP.	
		38082	POLEA	
		K060942	SERPENTIN	
		38174	TENSOR MICRO-V	
V-8, 4.3 L	2000	22582	MANGUERA SUP.	
		K060942	SERPENTIN	
V-8, 4.3 L	1999	22582	MANGUERA SUP.	
		K060942	SERPENTIN	

**S420**

V-8, 4.2 L	1999	22595	MANGUERA INF.	
		K060988	SERPENTIN	
V-8, 4.2 L	1998	22595	MANGUERA INF.	
		K060988	SERPENTIN	

**S430**

V-8, 4.3 L	2005	38082	POLEA	
		K060942	SERPENTIN	
		38174	TENSOR MICRO-V	
V-8, 4.3 L	2004	38082	POLEA	
		K060942	SERPENTIN	
		38174	TENSOR MICRO-V	
V-8, 4.3 L	2003	38082	POLEA	
		K060942	SERPENTIN	
		38174	TENSOR MICRO-V	
V-8, 4.3 L	2002	38082	POLEA	
		K060942	SERPENTIN	
		38174	TENSOR MICRO-V	
V-8, 4.3 L	2001	38082	POLEA	
		K060942	SERPENTIN	
		38174	TENSOR MICRO-V	
V-8, 4.3 L	2000	K060942	SERPENTIN	

**S500**

V-8, 5.0 L	2005	38082	POLEA	
		K060942	SERPENTIN	
		38174	TENSOR MICRO-V	
V-8, 5.0 L	2004	38082	POLEA	
		K060942	SERPENTIN	
		38174	TENSOR MICRO-V	
V-8, 5.0 L	2003	38082	POLEA	
		K060942	SERPENTIN	
		38174	TENSOR MICRO-V	
V-8, 5.0 L	2002	38082	POLEA	
		K060942	SERPENTIN	
		38174	TENSOR MICRO-V	
V-8, 5.0 L	2001	38082	POLEA	
		K060942	SERPENTIN	
		38174	TENSOR MICRO-V	
V-8, 5.0 L	2000	K060942	SERPENTIN	
V-8, 5.0 L	1999	22595	MANGUERA INF.	
		K060988	SERPENTIN	

**S55**

V-8, 5.5 L	2005	k060970	SERPENTIN	
		38174	TENSOR MICRO-V	ALT. B. AGUA Y D.H.
V-8, 5.5 L	2004	k060970	SERPENTIN	
		38174	TENSOR MICRO-V	ALT. B. AGUA Y D.H.
V-8, 5.5 L	2003	k060970	SERPENTIN	
		38174	TENSOR MICRO-V	ALT. B. AGUA Y D.H.
V-8, 5.5 L	2002	38082	POLEA	
		K060942	SERPENTIN	
		38174	TENSOR MICRO-V	
V-8, 5.5 L	2001	38082	POLEA	
		K060942	SERPENTIN	
		38174	TENSOR MICRO-V	





<b>S600</b>			
V-12, 5.8 L	2001	K060923	SERPENTIN
V-12, 6.0 L	1999	K061015	SERPENTIN

<b>S600 L</b>			
V-12, 6.0 L	2000	K061015	SERPENTIN
V-12, 6.0 L	1999	K061020	SERPENTIN
V-12, 6.0 L	1998	K061020	SERPENTIN

<b>SL500</b>			
V-8, 5.0 L	2006	K060970	SERPENTIN
V-8, 5.0 L	2005	38082	POLEA
		k060938	SERPENTIN
		K060970	SERPENTIN
		38174	SENSOR MICRO-V
V-8, 5.0 L	2004	38082	POLEA
		k060938	SERPENTIN
		K060970	SERPENTIN
		38174	SENSOR MICRO-V
V-8, 5.0 L	2003	38082	POLEA
		K060970	SERPENTIN
		k060938	SERPENTIN
		38174	SENSOR MICRO-V
V-8, 5.0 L	2002	38082	POLEA
		K060942	SERPENTIN
		38174	SENSOR MICRO-V
V-8, 5.0 L	2001	38082	POLEA
		K060942	SERPENTIN
		38174	SENSOR MICRO-V
V-8, 5.0 L	2000	K060942	SERPENTIN
V-8, 5.0 L	1999	K060942	SERPENTIN
		K060988	SERPENTIN
V-8, 5.0 L	1998	K060988	SERPENTIN

<b>SL55</b>			
V-8, 5.5 L	2006	38174	SENSOR MICRO-V
V-8, 5.5 L	2005	38174	SENSOR MICRO-V
V-8, 5.5 L	2004	38174	SENSOR MICRO-V
V-8, 5.5 L	2003	38174	SENSOR MICRO-V

<b>SL600</b>			
V-12, 6.0 L	2001	38090	POLEA
		K061015	SERPENTIN
V-12, 6.0 L	2000	K061015	SERPENTIN
V-12, 6.0 L	1999	K061015	SERPENTIN
V-12, 6.0 L	1998	K061020	SERPENTIN

<b>SLK230</b>			
4 CIL, 2.3 L	2004	K060532	A.A
		K060735	ALT.
		38225	SENSOR MICRO-V
4 CIL, 2.3 L	2003	K060532	A.A
		K060735	ALT.
		38225	SENSOR MICRO-V
4 CIL, 2.3 L	2002	K060532	A.A
		K060735	ALT.
		38225	SENSOR MICRO-V
4 CIL, 2.3 L	2001	K060735	A.A.
		K060532	ALT.
		K060690	D.H. & A.A.
		22594	MANGUERA INF.
		22592	MANGUERA SUP.
		38225	SENSOR MICRO-V
4 CIL, 2.3 L	2000	K060735	A.A.
		K060532	ALT.
		K060690	D.H. & A.A.
		22594	MANGUERA INF.
		22592	MANGUERA SUP.
		31100	TAPON DE ACEITE
		31522	TAPON DE RADIADOR

4 CIL, 2.3 L	1999	33079	TERMOSTATO	195°F
		K060523	ALT.	C/AA
		K060739	D.H.	C/AA
		22593	MANGUERA INF.	
		22592	MANGUERA SUP.	
		31522	TAPON DE RADIADOR	(20 lbs) Sin Palanca
4 CIL, 2.3 L	1998	K060523	ALT.	C/AA
		K060739	D.H.	C/AA
		31100	TAPON DE ACEITE	
		31522	TAPON DE RADIADOR	(20 lbs) Sin Palanca

<b>SLK320</b>			
V-6, 3.2 L	2004	38082	POLEA
		K060942	SERPENTIN
		38174	SENSOR MICRO-V
V-6, 3.2 L	2003	38082	POLEA
		K060942	SERPENTIN
		38174	SENSOR MICRO-V
V-6, 3.2 L	2002	38082	POLEA
		K060942	SERPENTIN
		38174	SENSOR MICRO-V
V-6, 3.2 L	2001	38082	POLEA
		K060942	SERPENTIN
		38174	SENSOR MICRO-V
V-6, 3.2 L	2000	K060942	SERPENTIN
		31100	TAPON DE ACEITE

<b>SLK350</b>			
V-6, 3.2 L	2005	K060947	SERPENTIN
V-6, 3.5 L	2005	38082	POLEA

<b>SPRINTER</b>			
4 CIL, 2.2 L CDI	2010	38099	POLEA
		K060888	SERPENTIN
		K060900	SERPENTIN
		38415	SENSOR
4 CIL, 2.2 L CDI	2009	TH35087G1	TERMOSTATOS
		38099	POLEA
		K060888	SERPENTIN
		K060900	SERPENTIN
		38415	SENSOR
		TH35087G1	TERMOSTATOS
4 CIL, 2.2 L CDI	2008	38099	POLEA
		K060888	SERPENTIN
		K060900	SERPENTIN
		38415	SENSOR
		TH35087G1	TERMOSTATOS
4 CIL, 2.2 L CDI	2007	38099	POLEA
		K060888	SERPENTIN
		T38415	SENSOR MICRO-V
		TH-35087G1	TERMOSTATO
4 CIL, 2.2 L CDI	2006	38099	POLEA
		K060888	SERPENTIN
		T38415	SENSOR MICRO-V
		TH-35087G1	TERMOSTATO
5 CIL, 2.7 L CDI	2005	38099	POLEA
		K060895	SERPENTIN
		T38415	SENSOR MICRO-V
		TH-35087G1	TERMOSTATO
5 CIL, 2.7 L CDI	2004	38099	POLEA
		K060895	SERPENTIN
		T38415	SENSOR MICRO-V
		TH-35087G1	TERMOSTATO
5 CIL, 2.7 L CDI	2003	38099	POLEA
		K060895	SERPENTIN
		T38415	SENSOR MICRO-V
		TH-35087G1	TERMOSTATO

<b>VITO</b>			
4 CIL, 2.2 L	2010	38099	POLEA
		K060900	SERPENTIN
		K060888	SERPENTIN

4 CIL, 2.2 L	2010	38415	TENSOR	
4 CIL, 2.2 L	2009	38099	POLEA	2 PZAS.
		K060900	SERPENTIN	CON A.A.
		K060888	SERPENTIN	SIN A.A.
		38415	TENSOR	
4 CIL, 2.2 L	2008	38099	POLEA	2 PZAS.
		K060888	SERPENTIN	SIN A.A.
		K060900	SERPENTIN	CON A.A.
		38415	TENSOR	

V-8, 4.6 L	1999	33469	TERMOSTATO	195°F
		19764	CALEF. A MULTIPLE	
		18070	CALEF. A TUBO	
		80251	EDH	RETORNO
		22388	MANGUERA INF.	
		22392	MANGUERA SUP.	
		38006	POLEA LOCA	
		K060975	SERPENTIN	
		31109	TAPON DE ACEITE	
		31830	TAPON DE GASOLINA	SIN LLAVE REGULAR
		31406	TAPON DE RADIADOR	(16 lbs) Sin Palanca
		38132	TENSOR MICRO-V	
		33189	TERMOSTATO	195°F
		361330(802:	EDH	PRESION
		22388	MANGUERA INF.	
		22392	MANGUERA SUP.	
		38006	POLEA LOCA	
		K060975	SERPENTIN	
		31109	TAPON DE ACEITE	
		31830	TAPON DE GASOLINA	SIN LLAVE REGULAR
		31406	TAPON DE RADIADOR	(16 lbs) Sin Palanca
		38132	TENSOR MICRO-V	
		33189	TERMOSTATO	195°F
		80233	EDH	PRESION
		21927	MANGUERA INF.	
		22122	MANGUERA SUP.	
		38006	POLEA LOCA	
		K060975	SERPENTIN	
		31109	TAPON DE ACEITE	
		31830	TAPON DE GASOLINA	SIN LLAVE REGULAR
		31406	TAPON DE RADIADOR	(16 lbs) Sin Palanca
		38132	TENSOR MICRO-V	
		33189	TERMOSTATO	195°F

**MERCURY**

**GRAND MARQUIS**

V-8, 4.6 L	2005	92100	EDH	PRESION
		22788	MANG. INF.	C/ENFRIADOR DE ACEITE
		38006	POLEA TENSORA	
		K060908	SERPENTIN	
		31275	TAPON DE ACEITE	
		31841	TAPON DE GASOLINA	SIN LLAVE REGULAR
		31406	TAPON DE RADIADOR	(16 lbs) Sin Palanca
		38189	TENSOR MICRO-V	
V-8, 4.6 L	2004	92100	EDH	PRESION
		22788	MANGUERA INF.	C/ ENFRIADOR DE ACEITE
		36100	POLEA	
		K060910	SERPENTIN	C/AA
		31275	TAPON DE ACEITE	
		31830	TAPON DE GASOLINA	SIN LLAVE REGULAR
		31406	TAPON DE RADIADOR	(16 lbs) Sin Palanca
		38189	TENSOR MICRO-V	
		33469	TERMOSTATO	195°F
V-8, 4.6 L	2003	22788	MANG. INF.	C/ENFRIADOR DE ACEITE
		22994	MANG. SUP.	
		36100	POLEA	CON CANALES
		K060910	SERPENTIN	C/AA
		31830	TAPON DE GASOLINA	SIN LLAVE REGULAR
		31406	TAPON DE RADIADOR	(16 lbs) Sin Palanca
		38189	TENSOR MICRO-V	
		33469	TERMOSTATO	195°F
V-8, 4.6 L	2002	35B 5/8"	B.A. A TUBO	
		19764	CALEF. A MULTIPLE	
		18070	CALEF. A TUBO-1	
		361330(802:	EDH	PRESION
		22388	MANGUERA INF.	S/Enfriador de aceite
		22392	MANGUERA SUP.	
		K060919	SERPENTIN	
		35B 3/8"	TANQUE DE RECUP. A RADIAD	
		31109	TAPON DE ACEITE	
		31830	TAPON DE GASOLINA	SIN LLAVE REGULAR
		31406	TAPON DE RADIADOR	(16 lbs) Sin Palanca
		38189	TENSOR MICRO-V	
		33469	TERMOSTATO	195°F
V-8, 4.6 L	2001	19764	CALEF. A MULTIPLE	
		18070	CALEF. A TUBO-1	
		361330(802:	EDH	PRESION
		22388	MANG. INF.	CORTAR A MEDIDA
		22392	MANGUERA SUP.	
		K060915	SERPENTIN	
		31109	TAPON DE ACEITE	
		31828	TAPON DE GASOLINA	CON LLAVE REGULAR
		31406	TAPON DE RADIADOR	(16 lbs) Sin Palanca
		38189	TENSOR MICRO-V	
		33469	TERMOSTATO	195°F
V-8, 4.6 L	2000	19764	CALEF. A MULTIPLE	
		18070	CALEF. A TUBO-1	
		361330(802:	EDH	PRESION
		22388	MANG. INF.	CORTAR A MEDIDA
		22392	MANGUERA SUP.	
		K060915	SERPENTIN	
		31109	TAPON DE ACEITE	
		31828	TAPON DE GASOLINA	CON LLAVE REGULAR
		31406	TAPON DE RADIADOR	(16 lbs) Sin Palanca
		38189	TENSOR MICRO-V	

**MARINER**

V-6, 3.0 L	2009	K030195SF	B.A. STRECH FIT	
		91030	HERRAMIENTA INST. STRECH F	
		23271	MANGUERA INF.	
		38006	POLEA	
		K060448	SERPENTIN	
		31275	TAPON DE ACEITE	
		31842	TAPON DE GASOLINA	CON LLAVE
		31841	TAPON DE GASOLINA	
		31539	TAPONES DE RADIADOR	17 LBS.
		38279	TENSOR	
		33248	TERMOSTATOS	188°
V-6, 3.0 L	2008	K030195SF	B.A. STRECH FIT	
		91030	HERRAMIENTA INST. STRECH F	
		23271	MANGUERA INF.	
		38006	POLEA	
		K060448	SERPENTIN	JUN 24 2008 Y RECIENTES
		K060919	SERPENTIN	JUN 23 2008 Y ANTERIOR
		31275	TAPON DE ACEITE	
		31842	TAPON DE GASOLINA	CON LLAVE
		31841	TAPON DE GASOLINA	
		31539	TAPONES DE RADIADOR	17 LBS.
		38279	TENSOR	
		33248	TERMOSTATOS	188°
4 CIL, 2.3 L	2007	K060854	SERPENTIN	SIN A.A.
		K060895	SERPENTIN	CON A.A.
		31841	TAPON DE GASOLINA	
		31842	TAPON DE GASOLINA	CON LLAVE
		31539	TAPON DE RADIADOR	17 LIBRAS
		38408	TENSOR MICRO-V	
V-6, 3.0 L	2007	K030195SF	B.A. STRECH FIT	
		91030	HERRAMIENTA INST. STRECH F	
		23271	MANGUERA INF.	
		K060840	SERPENTIN	
		31275	TAPON DE ACEITE	
		31842	TAPON DE GASOLINA	CON LLAVE
		31841	TAPON DE GASOLINA	
		31539	TAPON DE RADIADOR	17 LIBRAS
		38279	TENSOR MICRO-V	
4 CIL, 2.3 L	2006	K060895	SERPENTIN	CON A.A.

4 CIL, 2.3 L	2006	K060854	SERPENTIN	SIN A.A.
		31842	TAPON DE GASOLINA	CON LLAVE
		31841	TAPON DE GASOLINA	
		31539	TAPON DE RADIADOR	17 LIBRAS
		38408	SENSOR MICRO-V	
4 CIL, 2.3 L	2005	K060895	SERPENTIN	CON A.A.
		K060854	SERPENTIN	SIN A.A.
		31842	TAPON DE GASOLINA	CON LLAVE
		31841	TAPON DE GASOLINA	
		31539	TAPON DE RADIADOR	17 LIBRAS
		38408	SENSOR MICRO-V	

		19105	CALEF. A MULTIPLE	
		91969	EDH	PRESION C/ASISTENCIA
		92042	EDH	PRESION
		22240	MANGUERA INF.	
		22304	MANGUERA INF.	
		22180	MANGUERA SUP.	
		38006	POLEA DEL TENSOR	
		38001	POLEA LOCA	
		K060721	SERPENTIN	C/AA
		K060623	SERPENTIN	S/AA
		K030267	SERPENTIN B.A.	C/AA
		31109	TAPON DE ACEITE	
		31637	TAPON DE GASOLINA	SIN LLAVE REGULAR
		31783	TAPON DE GASOLINA	CON LLAVE REGULAR
		31539	TAPON DE RADIADOR	(17 lbs) Sin Palanca
		31530	TAPON DE RADIADOR	(18 lbs) Sin Palanca
		38250	SENSOR MICRO-V	
		33248	TERMOSTATO	195°F
		T294	BANDA ARBOL DE LEVAS	{129 D x 25.4 mm}
		19060	CALEF. A TUBO-1	
		91968	EDH	PRESION
		92042	EDH	PRESION
		TCK294	KIT DE DISTRIBUCION	Ene 1998 hasta 28-Mar-99 T4;
		TCK294A	KIT DE DISTRIBUCION	29-Mar-99 hasta 2003 T42036
		22366	MANGUERA INF.	AUTOMATICO
		22367	MANGUERA INF.	MANUAL
		22239	MANGUERA SUP.	AUTOMATICO / MANUAL
		T42036	POLEA BANDA DE TIEMPO	SUPERIOR
		T42035	POLEA BANDA DE TIEMPO	SUPERIOR
		T42034	POLEA BANDA DE TIEMPO	INFERIOR
		38018	POLEA LOCA	
		K060827	SERPENTIN	C/AA
		K060802	SERPENTIN	S/AA
		31109	TAPON DE ACEITE	
		31637	TAPON DE GASOLINA	SIN LLAVE REGULAR
		31783	TAPON DE GASOLINA	CON LLAVE REGULAR
		31530	TAPON DE RADIADOR	(18 lbs) Sin Palanca
		31539	TAPON DE RADIADOR	(17 lbs) Sin Palanca
		T43003	TENSOR ARBOL DE LEVAS	
		38188	SENSOR MICRO-V	
		33339	TERMOSTATO	195°F
		BDH-6312	BOMBA DE DIR. HIDR.	
		19105	CALEF. A MULTIPLE	
		91969	EDH	PRESION C/ASISTENCIA
		92042	EDH	PRESION
		22240	INF. - RADIADOR A TUBO	
		22304	INF. - TUBO A TERMOSTATO	May 1999 & Anteriores
		22180	MANGUERA SUP.	
		38006	POLEA DEL TENSOR	
		38001	POLEA LOCA	
		K060623	SERPENTIN	S/AA
		K060721	SERPENTIN	C/AA
		K030267	SERPENTIN B.A.	
		31109	TAPON DE ACEITE	
		31637	TAPON DE GASOLINA	SIN LLAVE REGULAR
		31783	TAPON DE GASOLINA	CON LLAVE REGULAR
		31539	TAPON DE RADIADOR	(17 lbs) Sin Palanca
		31530	TAPON DE RADIADOR	(18 lbs) Sin Palanca
		38250	SENSOR MICRO-V	
		33238	TERMOSTATO	180°F
		33248	TERMOSTATO	195°F
		T294	BANDA ARBOL DE LEVAS	{129 D x 25.4 mm}
		BDH-6311	BOMBA DE DIR. HIDR.	
		91969	EDH	PRESION C/ASISTENCIA
		92042	EDH	PRESION
		TCK294	KIT DE DISTRIBUCION	Ene 1998 hasta 28-Mar-99 T4;
		22367	MANGUERA INF.	MANUAL
		22366	MANGUERA INF.	AUTOMATICO
		22239	MANGUERA SUP.	AUTOMATICO / MANUAL
		38008	POLEA	
		38018	POLEA	
		38006	POLEA	
		T42035	POLEA BANDA DE TIEMPO	SUPERIOR
		T42034	POLEA BANDA DE TIEMPO	INFERIOR
		K060832	SERPENTIN	C/AA >FEB











**MILAN**

4 CIL, 2.5 L	2010	K060868	SERPENTIN	
		38452	TENSOR	
V-6, 3.0 L	2010	K060448	SERPENTIN	
V-6, 3.0 L	2009	K030195SF	B.A. STRECH FIT	
		91030	HERRAMIENTA INST. STRECH F	
		38008	POLEA	RANURADA
		38006	POLEA	LISA
		K060919	SERPENTIN	
		31842	TAPON DE GASOLINA	CON LLAVE
		31841	TAPON DE GASOLINA	
		31406	TAPONES DE RADIADOR	16 LBS.
		38279	TENSOR	
		33238	TERMOSTATOS	180°
V-6, 3.0 L	2008	K030195SF	B.A. STRECH FIT	
		91030	HERRAMIENTA INST. STRECH F	
V-6, 3.0 L	2007	K030195SF	B.A. STRECH FIT	
		91030	HERRAMIENTA INST. STRECH F	
		38006	POLEA	
		38008	POLEA	
		K060919	SERPENTIN	
		31275	TAPON DE ACEITE	
		31841	TAPON DE GASOLINA	
		31842	TAPON DE GASOLINA	CON LLAVE
		31406	TAPON DE RADIADOR	16 LIBRAS
		38279	SENSOR MICRO-V	
		33248	TERMOSTATO	188 ° F
V-6, 3.0 L	2006	38008	POLEA	
		38006	POLEA	
		K060919	SERPENTIN	
		31275	TAPON DE ACEITE	
		31842	TAPON DE GASOLINA	CON LLAVE
		31841	TAPON DE GASOLINA	
		31406	TAPON DE RADIADOR	16 LIBRAS
		38279	SENSOR MICRO-V	
		33248	TERMOSTATO	188 ° F

**MYSTIQUE**

4 CIL, 2.0 L	2000	T294	BANDA ARBOL DE LEVAS	{129 D x 25.4 mm}
		19060	CALEF. A TUBO-1	
		91968	EDH	PRESION
		92042	EDH	PRESION
		TCK294A	KIT DE DISTRIBUCION	29-Mar-99 hasta 2003 T42036
		TCK294	KIT DE DISTRIBUCION	Ene 1998 hasta 28-Mar-99 T4;
		22366	MANGUERA INF.	AUTOMATICO
		22367	MANGUERA INF.	MANUAL
		22239	MANGUERA SUP.	AUTOMATICO / MANUAL
		38008	POLEA	
		T42036	POLEA BANDA DE TIEMPO	SUPERIOR
		T42034	POLEA BANDA DE TIEMPO	INFERIOR
		38018	POLEA LOCA	
		K060802	SERPENTIN	S/AA
		K060827	SERPENTIN	C/AA
		31117	TAPON DE ACEITE	
		31637	TAPON DE GASOLINA	SIN LLAVE REGULAR
		31783	TAPON DE GASOLINA	CON LLAVE REGULAR
		31530	TAPON DE RADIADOR	(18 lbs) Sin Palanca
		31539	TAPON DE RADIADOR	(17 lbs) Sin Palanca
		T43003	TENSOR ARBOL DE LEVAS	
		38188	SENSOR MICRO-V	
		33339	TERMOSTATO	195°F
V-6, 2.5 L	2000	BDH-6312	BOMBA DE DIR. HIDR.	

4 CIL, 2.0 L	1999	T294	BANDA ARBOL DE LEVAS	{129 D x 25.4 mm}
		19060	CALEF. A TUBO-1	
		91968	EDH	PRESION
		92042	EDH	PRESION
		TCK294	KIT DE DISTRIBUCION	Ene 1998 hasta 28-Mar-99 T4;
		TCK294A	KIT DE DISTRIBUCION	29-Mar-99 hasta 2003 T42036
		22366	MANGUERA INF.	AUTOMATICO
		22367	MANGUERA INF.	MANUAL
		22239	MANGUERA SUP.	AUTOMATICO / MANUAL
		T42036	POLEA BANDA DE TIEMPO	SUPERIOR
		T42035	POLEA BANDA DE TIEMPO	SUPERIOR
		T42034	POLEA BANDA DE TIEMPO	INFERIOR
		38018	POLEA LOCA	
		K060827	SERPENTIN	C/AA
		K060802	SERPENTIN	S/AA
		31109	TAPON DE ACEITE	
		31637	TAPON DE GASOLINA	SIN LLAVE REGULAR
		31783	TAPON DE GASOLINA	CON LLAVE REGULAR
		31530	TAPON DE RADIADOR	(18 lbs) Sin Palanca
		31539	TAPON DE RADIADOR	(17 lbs) Sin Palanca
		T43003	TENSOR ARBOL DE LEVAS	
		38188	SENSOR MICRO-V	
		33339	TERMOSTATO	195°F
V-6, 2.5 L	1999	BDH-6312	BOMBA DE DIR. HIDR.	
		19105	CALEF. A MULTIPLE	
		91969	EDH	PRESION C/ASISTENCIA
		92042	EDH	PRESION
		22240	INF. - RADIADOR A TUBO	
		22304	INF. - TUBO A TERMOSTATO	May 1999 & Anteriores
		22180	MANGUERA SUP.	
		38006	POLEA DEL TENSOR	
		38001	POLEA LOCA	
		K060623	SERPENTIN	S/AA
		K060721	SERPENTIN	C/AA
		K030267	SERPENTIN B.A.	
		31109	TAPON DE ACEITE	
		31637	TAPON DE GASOLINA	SIN LLAVE REGULAR
		31783	TAPON DE GASOLINA	CON LLAVE REGULAR
		31539	TAPON DE RADIADOR	(17 lbs) Sin Palanca
		31530	TAPON DE RADIADOR	(18 lbs) Sin Palanca
		38250	SENSOR MICRO-V	
		33238	TERMOSTATO	180°F
		33248	TERMOSTATO	195°F
		T294	BANDA ARBOL DE LEVAS	{129 D x 25.4 mm}
		BDH-6311	BOMBA DE DIR. HIDR.	
		91969	EDH	PRESION C/ASISTENCIA
		92042	EDH	PRESION
		TCK294	KIT DE DISTRIBUCION	Ene 1998 hasta 28-Mar-99 T4;
		22367	MANGUERA INF.	MANUAL
		22366	MANGUERA INF.	AUTOMATICO
		22239	MANGUERA SUP.	AUTOMATICO / MANUAL
		38008	POLEA	
		38018	POLEA	
		38006	POLEA	
		T42035	POLEA BANDA DE TIEMPO	SUPERIOR
		T42034	POLEA BANDA DE TIEMPO	INFERIOR
		K060832	SERPENTIN	C/AA >FEB

    				    						
4 CIL, 2.0 L	1998	K060858 K060806 31117 31637 31539 31530 T43003 38188 33339	SERPENTIN SERPENTIN TAPON DE ACEITE TAPON DE GASOLINA TAPON DE RADIADOR TAPON DE RADIADOR TENSOR ARBOL DE LEVAS TENSOR MICRO-V TERMOSTATO	C/AA, < ENE S/AA  SIN LLAVE REGULAR (17 lbs) Sin Palanca (18 lbs) Sin Palanca  195°F	V-6, 3.0 L	2002	31275 31830 31406 33248 92108 31275 31828 31406 33509	TAPON DE ACEITE TAPON DE GASOLINA TAPON DE RADIADOR TERMOSTATO EDH TAPON DE ACEITE TAPON DE GASOLINA TAPON DE RADIADOR TERMOSTATO	SIN LLAVE REGULAR (16 lbs) Sin Palanca 195°F PRESION DOHC  CON LLAVE REGULAR (16 lbs) Sin Palanca 195°F PRESION	
V-6, 2.5 L	1998	BDH-6312 92042 91969 22240 22304 22180 38006 38001 K060623 K060721 K030267 31109 31637 31539 31530 38250 33248	BOMBA DE DIR. HIDR. EDH EDH MANGUERA INF. MANGUERA INF. MANGUERA SUP. POLEA DEL TENSOR POLEA LOCA SERPENTIN SERPENTIN SERPENTIN B.A. TAPON DE ACEITE TAPON DE GASOLINA TAPON DE RADIADOR TAPON DE RADIADOR TENSOR MICRO-V TERMOSTATO	PRESION PRESION C/ASISTENCIA   V-6, 3.0 L  S/AA C/AA C/AA  SIN LLAVE REGULAR (17 lbs) Sin Palanca (18 lbs) Sin Palanca SERPENTIN 195°F	V-6, 3.0 L	2001	91970 31275 31828 31406 33509 92024 31109 31830 31406 33509 92024 31109 31830 31406 33509	EDH TAPON DE ACEITE TAPON DE GASOLINA TAPON DE RADIADOR TERMOSTATO EDH TAPON DE ACEITE TAPON DE GASOLINA TAPON DE RADIADOR TERMOSTATO EDH TAPON DE ACEITE TAPON DE GASOLINA TAPON DE RADIADOR TERMOSTATO	CON LLAVE REGULAR (16 lbs) Sin Palanca 195°F PRESION  CON LLAVE REGULAR (16 lbs) Sin Palanca 195°F PRESION DOHC  SIN LLAVE REGULAR (16 lbs) Sin Palanca 195°F PRESION DOHC	
4 CIL, 2.0 L	1997	T258 BDH-6311 91837 TCK258 22178 22179 22239 38001 T42032 T42033 K060733 K060682 31117 31615 31530 T41008 38160 33339	BANDA ARBOL DE LEVAS BOMBA DE DIR. HIDR. EDH KIT DE DISTRIBUCION MANGUERA INF. MANGUERA INF. MANGUERA SUP. POLEA POLEA BANDA DE TIEMPO POLEA BANDA DE TIEMPO SERPENTIN SERPENTIN TAPON DE ACEITE TAPON DE GASOLINA TAPON DE RADIADOR TENSOR ARBOL DE LEVAS TENSOR MICRO-V TERMOSTATO	PRESION  V-6, 3.0 L  MANUAL AUTOMATICO AUTOMATICO / MANUAL  MANO IZQUIERDA MANO DERECHA C/AA S/AA  SIN LLAVE C/CONT. DE EMIS (18 lbs) Sin Palanca  195°F	V-6, 3.0 L	1997	91978 31109 31828 31406 33238 91978 31109 31830 31406 33238	EDH TAPON DE GASOLINA TAPON DE RADIADOR TERMOSTATO EDH TAPON DE ACEITE TAPON DE GASOLINA TAPON DE RADIADOR TERMOSTATO	PRESION DOHC  CON LLAVE REGULAR (16 lbs) Sin Palanca 180°F PRESION DOHC  SIN LLAVE REGULAR (16 lbs) Sin Palanca 180°F	
V-6, 2.5 L	1997	K030267 BDH-6312 91838 CH-130052 22240 22304 22180 38006 38001 K060716 K060623 31109 31615 31530 38250 33339 33238	ALT & A.A. BOMBA DE DIR. HIDR. EDH MANGUERA INF. MANGUERA INF. MANGUERA INF. MANGUERA SUP. POLEA DEL TENSOR POLEA LOCA SERPENTIN SERPENTIN TAPON DE ACEITE TAPON DE GASOLINA TAPON DE RADIADOR TENSOR MICRO-V TERMOSTATO TERMOSTATO	C/AA  PRESION     C/AA S/AA  SIN LLAVE C/CONT. DE EMIS (18 lbs) Sin Palanca SERPENTIN 195°F 180°F	V-6, 3.0 L	2004	22505 22242 38006 K030267 K060854 K060815 38114 38186 22505 22811 22242 38001 38006 K060815 K060854 K030267 38114 38186 22811 22505 22242 38001 38006 K060815 K060854 K030267	MANG. INF. MANG. INF. MANG. SUP. POLEA TENSORA SERPENTIN SERPENTIN SERPENTIN TENSOR MICRO-V TENSOR MICRO-V MANG. INF. MANG. INF. MANG. SUP. POLEA LOCA POLEA TENSORA SERPENTIN SERPENTIN SERPENTIN TENSOR MICRO-V TENSOR MICRO-V MANG. INF. MANG. INF. MANG. SUP. POLEA LOCA POLEA TENSORA SERPENTIN SERPENTIN SERPENTIN TENSOR MICRO-V TENSOR MICRO-V MANG. INF. MANG. INF. MANG. SUP. POLEA LOCA POLEA TENSORA SERPENTIN SERPENTIN SERPENTIN TENSOR MICRO-V TENSOR MICRO-V B.A., MULTIPLE CALEF. A TUBO-1 CALEF. A TUBO-2 MANGUERA INF. MANGUERA SUP. MULTIPLE A VALV. REG. DE AIR POLEA DEL TENSOR POLEA LOCA SERPENTIN	C/MOTOR DE 24 VALVULAS C/MOTOR DE 12 VALVULAS C/MOTOR DE 12 VALVULAS B.A. C/MOTOR DE 24 VALVUL C/MOTOR DE 12 VALVULAS C/MOTOR DE 24 VALVULAS C/MOTOR DE 12 VALVULAS C/MOTOR DE 24 VALVULAS C/MOTOR DE 12 VALVULAS C/MOTOR DE 24 VALVULAS C/MOTOR DE 12 VALVULAS C/MOTOR DE 24 VALVULAS ACCESORIOS C/MOTOR DE 24 VALVULAS C/MOTOR DE 12 VALVULAS B.A. C/MOTOR DE 24 VALVUL C/MOTOR DE 12 VALVULAS C/MOTOR DE 24 VALVULAS C/MOTOR DE 12 VALVULAS C/MOTOR DE 24 VALVULAS C/MOTOR DE 12 VALVULAS C/MOTOR DE 24 VALVULAS ACCESORIOS C/MOTOR DE 24 VALVULAS C/MOTOR DE 12 VALVULAS B.A. C/MOTOR DE 24 VALVUL C/MOTOR DE 12 VALVULAS C/MOTOR DE 24 VALVULAS DOHC S/motor HV S/motor HV S/motor HV S/motor HV S/motor HV S/motor HV S/motor HV DOHC	
<b>SABLE / TAURUS</b>										
V-6, 3.0 L	2005	92108 31275 31830 31406 33248	EDH TAPON DE ACEITE TAPON DE GASOLINA TAPON DE RADIADOR TERMOSTATO	PRESION DOHC  SIN LLAVE REGULAR (16 lbs) Sin Palanca 195°F	V-6, 3.0 L	2002	38114 38186 22571 28466 28466 22505 22242 28408 38006 38001 K060815	TENSOR MICRO-V TENSOR MICRO-V B.A., MULTIPLE CALEF. A TUBO-1 CALEF. A TUBO-2 MANGUERA INF. MANGUERA SUP. MULTIPLE A VALV. REG. DE AIR POLEA DEL TENSOR POLEA LOCA SERPENTIN	C/MOTOR DE 12 VALVULAS C/MOTOR DE 24 VALVULAS DOHC S/motor HV S/motor HV S/motor HV S/motor HV S/motor HV S/motor HV S/motor HV DOHC	
V-6, 3.0 L	2004	92108 31275 31830 31406 33248	EDH TAPON DE ACEITE TAPON DE GASOLINA TAPON DE RADIADOR TERMOSTATO	PRESION DOHC  SIN LLAVE REGULAR (16 lbs) Sin Palanca 195°F	V-6, 3.0 L	2003	92108	EDH	PRESION DOHC	
V-6, 3.0 L	2003	92108	EDH	PRESION DOHC	V-6, 3.0 L	2003	92108	EDH	PRESION DOHC	











**SABLE**

V-6, 3.0 L	2005	92108 31275 31830 31406 33248	EDH TAPON DE ACEITE TAPON DE GASOLINA TAPON DE RADIADOR TERMOSTATO	PRESION DOHC  SIN LLAVE REGULAR (16 lbs) Sin Palanca 195°F	V-6, 3.0 L	2002	38114 38186 22571 28466 28466 22505 22242 28408 38006 38001 K060815	TENSOR MICRO-V TENSOR MICRO-V B.A., MULTIPLE CALEF. A TUBO-1 CALEF. A TUBO-2 MANGUERA INF. MANGUERA SUP. MULTIPLE A VALV. REG. DE AIR POLEA DEL TENSOR POLEA LOCA SERPENTIN	C/MOTOR DE 12 VALVULAS C/MOTOR DE 24 VALVULAS DOHC S/motor HV S/motor HV S/motor HV S/motor HV S/motor HV S/motor HV S/motor HV DOHC
V-6, 3.0 L	2004	92108 31275 31830 31406 33248	EDH TAPON DE ACEITE TAPON DE GASOLINA TAPON DE RADIADOR TERMOSTATO	PRESION DOHC  SIN LLAVE REGULAR (16 lbs) Sin Palanca 195°F	V-6, 3.0 L	2003	92108	EDH	PRESION DOHC
V-6, 3.0 L	2003	92108	EDH	PRESION DOHC	V-6, 3.0 L	2003	92108	EDH	PRESION DOHC

















									
4 CIL, 1.6 L	2006	33849	TERMOSTATO	195°F					
4 CIL, 1.6 L	2005	23290	B.A.				T42018	POLEA BANDA DE TIEMPO	
		23376	MANGUERA INF.	SIN SUPERCARGADO			K040355	SERPENTIN	
		23374	MANGUERA INF.	CON SUPERCARGADO			K060470	SERPENTIN	ALT. & A.A.
		23375	MANGUERA INF.	CON SUPERCARGADO			31085	TAPON DE ACEITE	
		23373	MANGUERA SUP.	SIN SUPERCARGADO			31836	TAPON DE GASOLINA	CON LLAVE REGULAR
		23378	MANGUERA SUP.	CON SUPERCARGADO			31412	TAPON DE RADIADOR	(16 lbs) Sin Palanca
		23377	MANGUERA SUP.	CON SUPERCARGADO			T41039	SENSOR ARBOL DE LEVAS	
		36168	POLEA	CON SUPERCARGADO			33878	TERMOSTATO	180°F
		K060547	SERPENTIN	ALT. / B.A. CON SUPERCARG					
		K060415	SERPENTIN	A.A.					
		K060408	SERPENTIN	ALT. / B.A. SIN SUPERCARGA					
		31118	TAPON DE ACEITE						
		31848	TAPON DE GASOLINA						
		31528	TAPON DE RADIADOR	(16 lbs) Sin Palanca					
		38405	TENSOR	SIN SUPERCARGADO					
		38404	TENSOR	CON SUPERCARGADO					
		33849	TERMOSTATO	195°F					

**ENDEAVOR**

<b>MITSUBISHI</b>									
<b>ECLIPSE</b>									
V-6, 3.8 L	2008	T287	BANDA ARBOL DE LEVAS	195 D X 32MM					
		TCK287	KIT DE DISTRIBUCION						
		36271	POLEA						
		T42018	POLEA DE DISTRIBUCION						
		31085	TAPON DE ACEITE						
		31838	TAPON DE GASOLINA						
		31836	TAPON DE GASOLINA	CON LLAVE					
		31412	TAPONES DE RADIADOR	16 LBS.					
		T41039	TENSOR						
		T43190	TENSOR HIDRAULICO						
		33878	TERMOSTATOS	180°	V-6, 3.8 L	2005	T287	BANDA ARBOL DE LEVAS	
V-6, 3.8 L	2007	T287	BANDA ARBOL DE LEVAS	195 D X 32MM			TCK287	KIT DE DISTRIBUCION	
		TCK287	KIT DE DISTRIBUCION				22870	MANG. INF.	
		18868	MANG. CALEF. A ENF. DE ACEIT				22871	MANG. SUP.	
		18849	MANG. DE CALEFACCION				T42018	POLEA BANDA DE TIEMPO	
		21596	MANG. INF.				K060470	SERPENTIN	ALT. & A.A.
		22183	MANG. SUP.				K040358	SERPENTIN	D.H.
		36271	POLEA				31085	TAPON DE ACEITE	
		T42018	POLEA DE DISTRIBUCION				31838	TAPON DE GASOLINA	SIN LLAVE REGULAR
		K060470	SERPENTIN	ALT. & A.A.			31412	TAPON DE RADIADOR	(16 lbs) Sin Palanca
		K040358	SERPENTIN	D.H.			T41039	TENSOR ARBOL DE LEVAS	
		31085	TAPON DE ACEITE				33878	TERMOSTATO	180°F
		31836	TAPON DE GASOLINA	CON LLAVE	V-6, 3.8 L	2004	T287	BANDA ARBOL DE LEVAS	
		31838	TAPON DE GASOLINA				TCK287	KIT DE DISTRIBUCION	
		31412	TAPONES DE RADIADOR	16 LBS.			22870	MANGUERA INF.	
		T41039	TENSOR				22871	MANGUERA SUP.	
		T43190	TENSOR HIDRAULICO				T42018	POLEA BANDA DE TIEMPO	
		33878	TERMOSTATOS	180°			K040358	SERPENTIN	
V-6, 3.8 L	2006	18849	MANG. DE CALEFACCION				K060470	SERPENTIN	
		18868	MANG. DE CALEFACCION				31085	TAPON DE ACEITE	
		21596	MANG. INF.				31836	TAPON DE GASOLINA	CON LLAVE REGULAR
		22183	MANG. SUP.				31412	TAPON DE RADIADOR	(16 lbs) Sin Palanca
		K060470	SERPENTIN	ALT. & A.A.			T41039	TENSOR ARBOL DE LEVAS	
		K040358	SERPENTIN	D.H.			33878	TERMOSTATO	180°F
V-6, 3.0 L	2005	T259	BANDA ARBOL DE LEVAS						
		TCK259	KIT DE DISTRIBUCION						
		22628	MANG. INF.						
		21557	MANG. SUP.						
		T42018	POLEA BANDA DE TIEMPO						
		K060470	SERPENTIN						
		K040355	SERPENTIN	D.H.					
		31085	TAPON DE ACEITE						
		31838	TAPON DE GASOLINA	SIN LLAVE REGULAR					
		31412	TAPON DE RADIADOR	(16 lbs) Sin Palanca					
		T41039	TENSOR ARBOL DE LEVAS						
		33878	TERMOSTATO	180°F					
V-6, 3.0 L	2004	T259	BANDA ARBOL DE LEVAS						
		TCK259	KIT DE DISTRIBUCION						
		22628	MANGUERA INF.						
		21557	MANGUERA SUP.						

**GALANT**

4 CIL, 2.4 L	2007	T168	BANDA ARBOL DE LEVAS						
		K060744	SERPENTIN						
		31085	TAPON DE ACEITE						
		31838	TAPON DE GASOLINA						SIN LLAVE REGULAR
		31412	TAPON DE RADIADOR						(16 lbs) Sin Palanca
		T41038	TENSOR ARBOL DE LEVAS						BANDA DISTRIBUIDOR FLECI
		33868	TERMOSTATO						180°F
		T287	BANDA ARBOL DE LEVAS						
		TCK287	KIT DE DISTRIBUCION						
		22984	MANG. INF.						
		22983	MANG. SUP.						
		K060470	SERPENTIN						ALT. & A.A.
		K040358	SERPENTIN						D.H.
		31085	TAPON DE ACEITE						

    				    					
V-6, 3.8 L	2007	31838 31412 33878	TAPON DE GASOLINA TAPON DE RADIADOR TERMOSTATO	SIN LLAVE REGULAR (16 lbs) Sin Palanca 180°F	2008	T724 5641XS K060588	BALANCIN BANDA ARBOL DE LEVAS SERPENTIN	99 D X 19MM  ALT. / D.H.	
4 CIL, 2.4 L	2006	T168 T332 K060744 31085 31838 31412 T41038 33868	BANDA ARBOL DE LEVAS BANDA ARBOL DE LEVAS SERPENTIN TAPON DE ACEITE TAPON DE GASOLINA TAPON DE RADIADOR SENSOR ARBOL DE LEVAS TERMOSTATO	FLECHA BALANCIN	<b>LANCER</b>				
V-6, 3.8 L	2006	T287 TCK287 22984 22983 K040358 K060470 31085 31838 31412 33878	BANDA ARBOL DE LEVAS KIT DE DISTRIBUCION MANG. INF. MANG. SUP. SERPENTIN SERPENTIN TAPON DE ACEITE TAPON DE GASOLINA TAPON DE RADIADOR TERMOSTATO	SIN LLAVE REGULAR (16 lbs) Sin Palanca 180°F	4 CIL, 2.0 L	2008	T201 TCK201 19416 19415 22720 22989 22988 K061010 K061033 31085 31832 31780 31534 T41212 33987	BANDA ARBOL DE LEVAS KIT DE DISTRIBUCION MANGUERA CALEFACCION MANGUERA CALEFACCION MANGUERA INF. MANGUERA INF. MANGUERA SUP. SERPENTIN SERPENTIN TAPON DE ACEITE TAPON DE GASOLINA TAPON DE GASOLINA TAPONES DE RADIADOR SENSOR TERMOSTATOS	121 D X 29MM  SALIDA ENTRADA T.A. T.M.  SIN TURBO CON TURBO  CON LLAVE 16 LBS.  180°
4 CIL, 2.4 L	2005	T168 K060744 31085 31838 31412 T41038 33868	BANDA ARBOL DE LEVAS SERPENTIN TAPON DE ACEITE TAPON DE GASOLINA TAPON DE RADIADOR SENSOR ARBOL DE LEVAS TERMOSTATO	SIN LLAVE REGULAR (16 lbs) Sin Palanca 180°F	4 CIL, 2.0 L	2007	T201 TCK201 19415 19416 22720 22989 22988 K050510 K040305 K050425 31085 31832 31780 31534 T41212 33987	BANDA ARBOL DE LEVAS KIT DE DISTRIBUCION MANGUERA CALEFACCION MANGUERA CALEFACCION MANGUERA INF. MANGUERA INF. MANGUERA SUP. SERPENTIN SERPENTIN SERPENTIN TAPON DE ACEITE TAPON DE GASOLINA TAPON DE GASOLINA TAPONES DE RADIADOR SENSOR TERMOSTATOS	121 D X 29MM  ENTRADA SALIDA T.A. T.M.  CON A.A. ALTERNADOR SIN A.A.  CON LLAVE 16 LBS.  180°
V-6, 3.8 L	2005	T287 TCK287 22984 22983 T42018 K060470 K040358 31085 31838 31412 T41039 33878	BANDA ARBOL DE LEVAS KIT DE DISTRIBUCION MANG. INF. MANG. SUP. POLEA BANDA DE TIEMPO SERPENTIN SERPENTIN TAPON DE ACEITE TAPON DE GASOLINA TAPON DE RADIADOR SENSOR ARBOL DE LEVAS TERMOSTATO	SIN LLAVE REGULAR (16 lbs) Sin Palanca 180°F	4 CIL, 2.0 L	2006	T167 T201 T168 22720 22887 22888 22988 K050425 K060705 K040305 31085 31832 31336 T41038 33945	BANDA ARBOL DE LEVAS BANDA ARBOL DE LEVAS BANDA ARBOL DE LEVAS MANG. INF. MANG. INF. MANG. SUP. MANG. SUP. SERPENTIN SERPENTIN SERPENTIN TAPON DE ACEITE TAPON DE GASOLINA TAPON DE RADIADOR SENSOR ARBOL DE LEVAS TERMOSTATO	C/TURBO SIN TURBO {121 D x 29.0 mm} BALANCIN S/TURBO C/TRANS. AUTO C/TURBO C/TURBO S/TURBO D.H. S/TURBO C/TURBO ALT. S/TURBO  SIN LLAVE REGULAR (16 lbs) Sin Palanca BALANCIN 195°F
4 CIL, 2.4 L	2004	T168 K060744 31085 31836 31838 31412 T41038 33868	BANDA ARBOL DE LEVAS SERPENTIN TAPON DE ACEITE TAPON DE GASOLINA TAPON DE GASOLINA TAPON DE RADIADOR SENSOR ARBOL DE LEVAS TERMOSTATO	CON LLAVE REGULAR SIN LLAVE REGULAR (16 lbs) Sin Palanca 180°F	4 CIL, 2.4 L	2006	T332 T168 22987 22986 22985 K060739 31085 31832 31336 33868	BANDA ARBOL DE LEVAS BANDA ARBOL DE LEVAS MANG. INF. MANG. INF. MANG. SUP. MANG. SUP. SERPENTIN SERPENTIN TAPON DE ACEITE TAPON DE GASOLINA TAPON DE RADIADOR TERMOSTATO	{122 D x 20 mm}  BALANCIN C/TURBO C/TURBO S/TURBO C/TRANS. AUTO C/TURBO C/TURBO ALT. S/TURBO S/TURBO D.H. S/TURBO  SIN LLAVE REGULAR (16 lbs) Sin Palanca 180°F
V-6, 3.8 L	2004	T287 TCK287 T42018 K040358 K060470 31085 31836 31838 31412 T41039 33878	BANDA ARBOL DE LEVAS KIT DE DISTRIBUCION POLEA BANDA DE TIEMPO SERPENTIN SERPENTIN TAPON DE ACEITE TAPON DE GASOLINA TAPON DE GASOLINA TAPON DE RADIADOR SENSOR ARBOL DE LEVAS TERMOSTATO	CON LLAVE REGULAR SIN LLAVE REGULAR (16 lbs) Sin Palanca 180°F	4 CIL, 2.4 L	2006	T332 T168 22987 22986 22985 K060739 31085 31832 31336 33868	BANDA ARBOL DE LEVAS BANDA ARBOL DE LEVAS MANG. INF. MANG. INF. MANG. SUP. MANG. SUP. SERPENTIN SERPENTIN TAPON DE ACEITE TAPON DE GASOLINA TAPON DE RADIADOR TERMOSTATO	{122 D x 20 mm} BALANCIN C/TRANS MANUAL C/TRANS AUTO  SIN LLAVE REGULAR (16 lbs) Sin Palanca 180°F
<b>GRANDIS</b>									
4 CIL, 2.4 L	2008	T168 T332 K060739 38413	BANDA ARBOL DE LEVAS BANDA ARBOL DE LEVAS SERPENTIN SENSOR	BALANCIN {122 D x 20 mm}	4 CIL, 2.0 L	2005	T167 T168 22887 22720 22988 22888 T42017 K040305 K060705 K050425 31085 31832 31336 33868	BANDA ARBOL DE LEVAS BANDA ARBOL DE LEVAS MANG. INF. MANG. INF. MANG. SUP. MANG. SUP. POLEA BANDA DE TIEMPO SERPENTIN SERPENTIN SERPENTIN TAPON DE ACEITE TAPON DE GASOLINA TAPON DE RADIADOR TERMOSTATO	C/TURBO BALANCIN C/TURBO S/TURBO C/TRANS. AUTO S/TURBO C/TURBO ALT. S/TURBO S/TURBO D.H. S/TURBO  SIN LLAVE REGULAR (16 lbs) Sin Palanca 180°F
4 CIL, 2.4 L	2007	T332 T168 K060739 38413	BANDA ARBOL DE LEVAS BANDA ARBOL DE LEVAS SERPENTIN SENSOR	{122 D x 20 mm} BALANCIN{65 D x 12.7 mm}					
<b>L200</b>									
4 CIL, 2.5 L	2009	T724 5641XS K060588	BALANCIN BANDA ARBOL DE LEVAS SERPENTIN	99 D X 19MM  ALT. / D.H.					

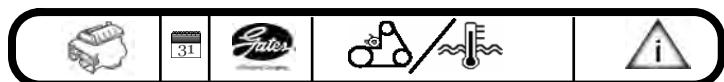

4 CIL, 2.0 L	2005	T41038 T41212 33945	TENSOR ARBOL DE LEVAS TENSOR ARBOL DE LEVAS THERMOSTATO	195°F
4 CIL, 2.4 L	2005	T168 T332 22986 22987 22985 K060739 31085 31832 31336 T41038 33868	BANDA ARBOL DE LEVAS BANDA ARBOL DE LEVAS MANG. INF. MANG. INF. MANG. SUP. SERPENTIN TAPON DE ACEITE TAPON DE GASOLINA TAPON DE RADIADOR TENSOR ARBOL DE LEVAS THERMOSTATO	BALANCIN {122 D x 20 mm} C/TRANS AUTO C/TRANS MANUAL
4 CIL, 2.0 L	2004	T201 22887 22720 22888 T42017 K060705 31085 31832 31780 31336 T41038 T41212 33945	BANDA ARBOL DE LEVAS MANGUERA INF. MANGUERA INF. MANGUERA SUP. POLEA BANDA DE TIEMPO SERPENTIN TAPON DE ACEITE TAPON DE GASOLINA TAPON DE GASOLINA TAPON DE RADIADOR TENSOR ARBOL DE LEVAS TENSOR ARBOL DE LEVAS THERMOSTATO	SIN LLAVE REGULAR (16 lbs) Sin Palanca  180°F {121 D x 29.0 mm}
4 CIL, 2.4 L	2004	T332 T168 22986 22987 22985 K060739 31085 31832 31780 31336 T41038 33868	BANDA ARBOL DE LEVAS BANDA ARBOL DE LEVAS MANG. INF. MANG. INF. MANG. SUP. SERPENTIN TAPON DE ACEITE TAPON DE GASOLINA TAPON DE GASOLINA TAPON DE RADIADOR TENSOR ARBOL DE LEVAS TENSOR ARBOL DE LEVAS THERMOSTATO	195°F {122 D x 20 mm} BALANCIN C/TRANS AUTO C/TRANS MANUAL  SIN LLAVE REGULAR CON LLAVE REGULAR (16 lbs) Sin Palanca  180°F



T42018 K070951 31085 31780 31336 T41039 33878	POLEA BANDA DE TIEMPO SERPENTIN TAPON DE ACEITE TAPON DE GASOLINA TAPON DE RADIADOR TENSOR ARBOL DE LEVAS THERMOSTATO	180°F
---	---	-------

**MONTERO SPORT**

V-6, 3.5 L	2004	TCK287 22658 21744 T42018 K040395 K050446 31085 31780 31412 T41039 33878 A33	KIT DE DISTRIBUCION MANGUERA INF. MANGUERA SUP. POLEA BANDA DE TIEMPO SERPENTIN SERPENTIN TAPON DE ACEITE TAPON DE GASOLINA TAPON DE RADIADOR TENSOR ARBOL DE LEVAS THERMOSTATO TRANSMISION DE ACCESORIOS	180°F A.A.
------------	------	---	--	---------------

**OUTLANDER**

V-6, 3.0 L	2008	T339 19520 19519 23412 23425 23424 K060468 K040388 31118 31832 31780 31534 T43189 33878	BANDA ARBOL DE LEVAS MANGUERA CALEFACCION MANGUERA CALEFACCION MANGUERA INF. MANGUERA SUP. MANGUERA SUP. SERPENTIN SERPENTIN TAPON DE ACEITE TAPON DE GASOLINA TAPON DE GASOLINA TAPONES DE RADIADOR TENSOR THERMOSTATOS	179 D X 20MM ENTRADA SALIDA LADO IZQ. LADO DER. ALT. / A.A. D.H.  CON LLAVE 16 LBS. 180°
V-6, 3.0 L	2007	T339 19520 23412 23424 23425 K040388 K060468 31118 31832 31780 31534 T43189 33878	BANDA ARBOL DE LEVAS MANGUERA CALEFACCION MANGUERA CALEFACCION MANGUERA INF. MANGUERA SUP. MANGUERA SUP. SERPENTIN SERPENTIN TAPON DE ACEITE TAPON DE GASOLINA TAPON DE GASOLINA TAPONES DE RADIADOR TENSOR THERMOSTATOS	179 D X 20MM SALIDA ENTRADA LADO DER. LADO IZQ. D.H. ALT. / A.A.  CON LLAVE 16 LBS. 180°
4 CIL, 2.4 L	2006	T168 T332 22871 K060744 31085 31832 31336 T41038 33868	BANDA ARBOL DE LEVAS BANDA ARBOL DE LEVAS MANG. SUP. SERPENTIN TAPON DE ACEITE TAPON DE GASOLINA TAPON DE RADIADOR TENSOR ARBOL DE LEVAS THERMOSTATO	BALANCIN {122 D x 20 mm}
4 CIL, 2.4 L	2005	T332 T168 23064 22871 K060744 31085 31832 31336 T41038 33868	BANDA ARBOL DE LEVAS BANDA ARBOL DE LEVAS MANG. INF. MANG. SUP. SERPENTIN TAPON DE ACEITE TAPON DE GASOLINA TAPON DE RADIADOR TENSOR ARBOL DE LEVAS THERMOSTATO	BALANCIN {122 D x 20 mm}
4 CIL, 2.4 L	2004	T332 T168 22871 K060744	BANDA ARBOL DE LEVAS BANDA ARBOL DE LEVAS MANG. SUP. SERPENTIN	BALANCIN {122 D x 20 mm}

**MONTERO**

V-6, 3.8 L	2007	T320 22657 22656 T42018 K070951 31085 31832 31336 T41039 33878	BANDA ARBOL DE LEVAS MANG. INF. MANG. SUP. POLEA BANDA DE TIEMPO SERPENTIN TAPON DE ACEITE TAPON DE GASOLINA TAPON DE RADIADOR TENSOR ARBOL DE LEVAS THERMOSTATO	CORTAR A MEDIDA  SIN LLAVE REGULAR (16 lbs) Sin Palanca  180°F
V-6, 3.8 L	2006	T320 22657 22656 T42018 K070951 31085 31832 31336 T41039 33878	BANDA ARBOL DE LEVAS MANG. INF. MANG. SUP. POLEA BANDA DE TIEMPO SERPENTIN TAPON DE ACEITE TAPON DE GASOLINA TAPON DE RADIADOR TENSOR ARBOL DE LEVAS THERMOSTATO	{201 D x 32 mm} CORTAR A MEDIDA  SIN LLAVE REGULAR (16 lbs) Sin Palanca  180°F
V-6, 3.8 L	2005	T320 22657 22656 T42018 K070951 31085 31832 31336 T41039 33878	BANDA ARBOL DE LEVAS MANG. INF. MANG. SUP. POLEA BANDA DE TIEMPO SERPENTIN TAPON DE ACEITE TAPON DE GASOLINA TAPON DE RADIADOR TENSOR ARBOL DE LEVAS THERMOSTATO	{201 D x 32 mm} CORTAR A MEDIDA  SIN LLAVE REGULAR (16 lbs) Sin Palanca  180°F
V-6, 3.8 L	2004	T320 22657 22656	BANDA ARBOL DE LEVAS MANGUERA INF. MANGUERA SUP.	180°F

4 CIL, 2.4 L	2004	31085 31780 31336 T41038 33868	TAPON DE ACEITE TAPON DE GASOLINA TAPON DE RADIADOR SENSOR ARBOL DE LEVAS TERMOSTATO	CON LLAVE REGULAR (16 lbs) Sin Palanca  180°F

V-6, 3.5 L	2005	22968 22967 K060465 K040372 31115 31838 31533	MANG. INF. MANG. SUP. SERPENTIN SERPENTIN TAPON DE ACEITE TAPON DE GASOLINA TAPON DE RADIADOR	ALT. VENT. & D.H. A.A.  SIN LLAVE REGULAR (13 lbs) Con palanca
V-6, 3.5 L	2004	22968 22967 K040372 K060465 31115 31838 31533	MANG. INF. MANG. SUP. SERPENTIN SERPENTIN TAPON DE ACEITE TAPON DE GASOLINA TAPON DE RADIADOR	A.A. ALT. VENT. & D.H.  SIN LLAVE REGULAR (13 lbs) Con palanca
V-6, 3.5 L	2003	22968 22967 K040372 K060465 31115 31838 31533 31533	MANG. INF. MANG. SUP. SERPENTIN SERPENTIN TAPON DE ACEITE TAPON DE GASOLINA TAPON DE RADIADOR TAPON DE RADIADOR	SIN LLAVE REGULAR (13 lbs) Con palanca  A.A. ALTERNADOR  SIN LLAVE REGULAR (13 lbs) Sin palanca (13 lbs) Con palanca

**NISSAN**

**240SX**

4 CIL, 2.4 L	1998	K040355 K040305 K030395 91855 21921 22197 31115 31748 31333 31533 33747	A.A. ALT. D.H. EDH MANGUERA INF. MANGUERA SUP. TAPON DE ACEITE TAPON DE GASOLINA TAPON DE RADIADOR TAPON DE RADIADOR TERMOSTATO	PRESION  SIN LLAVE REGULAR (13 lbs) Sin palanca (13 lbs) Con palanca 170°F
4 CIL, 2.4 L	1997	K040355 K040305 K030395 91855 21921 22197 31115 31748 31333 31533 33747	A.A. ALT. D.H. EDH MANGUERA INF. MANGUERA SUP. TAPON DE ACEITE TAPON DE GASOLINA TAPON DE RADIADOR TAPON DE RADIADOR TERMOSTATO	PRESION  SIN LLAVE REGULAR (13 lbs) Sin palanca (13 lbs) Con palanca 170°F

**370Z**

V-6, 3.7 L	2009	23340 23339 36305 K070795 31115 31836 31838 33912	MANGUERA INF. MANGUERA SUP. POLEA SERPENTIN TAPON DE ACEITE TAPON DE GASOLINA TAPON DE GASOLINA TERMOSTATOS	CON LLAVE     180°
------------	------	--	--	-----------------------------------

**ALMERA**

4 CIL, 1.8 L	2006	K060433 K060325 K040335	SERPENTIN SERPENTIN SERPENTIN	A.A. ALTERNADOR D.H.
4 CIL, 1.8 L	2005	K040335 K060433 K060325	SERPENTIN SERPENTIN SERPENTIN	D.H. A.A. ALTERNADOR
4 CIL, 1.8 L	2004	K060325 K060433 K040335	SERPENTIN SERPENTIN SERPENTIN	ALTERNADOR A.A. D.H.
4 CIL, 1.8 L	2003	K040335 K060325 K060433	SERPENTIN SERPENTIN SERPENTIN	D.H. ALTERNADOR A.A.

**350Z**

V-6, 3.5 L	2009	23344 23343 36305 36306 K070810 K040220 31115 31838 31836 31534	MANGUERA INF. MANGUERA SUP. POLEA POLEA SERPENTIN SERPENTIN TAPON DE ACEITE TAPON DE GASOLINA TAPON DE GASOLINA TAPONES DE RADIADOR	RANURADA LISA SUPERCARGADO  CON LLAVE 16 LBS.
V-6, 3.5 L	2008	23344 23343 36305 36306 K070810 K040220 31115 31838 31836 31534	MANGUERA INF. MANGUERA SUP. POLEA POLEA SERPENTIN SERPENTIN TAPON DE ACEITE TAPON DE GASOLINA TAPON DE GASOLINA TAPONES DE RADIADOR	RANURADA LISA SUPERCARGADO  CON LLAVE 16 LBS.
V-6, 3.5 L	2007	23344 23343 36306 36305 K040220 K070810 31115 31838 31836 31534	MANGUERA INF. MANGUERA SUP. POLEA POLEA SERPENTIN SERPENTIN TAPON DE ACEITE TAPON DE GASOLINA TAPON DE GASOLINA TAPONES DE RADIADOR	LISA RANURADA SUPERCARGADO  CON LLAVE 16 LBS.
V-6, 3.5 L	2006	22968 22967 K060465 K040372 31115 31838 31533 33940	MANG. INF. MANG. SUP. SERPENTIN SERPENTIN TAPON DE ACEITE TAPON DE GASOLINA TAPON DE RADIADOR TERMOSTATO	ALT. VENT. & D.H. A.A.  SIN LLAVE REGULAR (13 lbs) Con palanca 170°F

**ALTIMA**





4 CIL, 2.5 L	2010	K060878 31115 31836 31838 31551 33941	SERPENTIN TAPON DE ACEITE TAPON DE GASOLINA TAPON DE GASOLINA TAPONES DE RADIADOR TERMOSTATOS	CON LLAVE   20LBS. 180°
4 CIL, 2.5 L	2009	23345 23353 23348 K060878 31115 31838 31836 31551 33941	MANGUERA INF. MANGUERA SUP. MANGUERA SUP. SERPENTIN TAPON DE ACEITE TAPON DE GASOLINA TAPON DE GASOLINA TAPONES DE RADIADOR TERMOSTATOS	RADIADOR AL TANQUE TANQUE A MOTOR   CON LLAVE 20LBS. 180°
V-6, 3.5 L	2009	19810 19722 23351 23352 23350 23353 K070669 31115 31836 31838	MANGUERA CALEFACCION MANGUERA CALEFACCION MANGUERA INF. MANGUERA INF. MANGUERA SUP. MANGUERA SUP. SERPENTIN TAPON DE ACEITE TAPON DE GASOLINA TAPON DE GASOLINA	LADO DER. LADO IZQ. RADIADOR AL TUBO TUBO A MOTOR TANQUE A MOTOR RADIADOR AL TANQUE  CON LLAVE













				
V-8, 5.6 L	2006	K070971 31115 31836 31838Y 31838 31534 38340 33878	SERPENTIN TAPON DE ACEITE TAPON DE GASOLINA TAPON DE GASOLINA TAPON DE GASOLINA TAPONES DE RADIADOR TENSOR TERMOSTATOS	CON LLAVE FLEX FUEL  16 LBS. 180°

				
4 CIL, 2.4 L	1999	CH-180031 6366L 8452L CH-180202 CH-180042 CH-180031	MANGUERA SUP. ALT. D.H. MANGUERA INF. MANGUERA INF. MANGUERA SUP.	S/AA, S/DH   S/AA, S/DH S/AA, S/DH
4 CIL, 2.4 L	1998	6366L 8452L CH-180202 CH-180042 CH-180031	ALT. D.H. MANGUERA INF. MANGUERA INF. MANGUERA SUP.	S/AA, S/DH S/AA, S/DH
4 CIL, 2.4 L	1997	6366L 8452L CH-180202	ALT. D.H. MANGUERA INF.	S/AA, S/DH

**CHASIS**

4 CIL, 2.4 L	2001	6366L 8452L CH-180042 CH-180031	ALT. D.H. MANGUERA INF. MANGUERA SUP.	S/AA, C/DH, 65 A S/AA, C/DH, 65 A
4 CIL, 2.4 L	2000	6366L 8452L CH-180042 CH-180031	ALT. D.H. MANGUERA INF. MANGUERA SUP.	S/AA, C/DH, 65 A S/AA, C/DH, 65 A
4 CIL, 2.4 L	1999	6366L 8452L CH-180042 CH-180031	ALT. D.H. MANGUERA INF. MANGUERA SUP.	S/AA, C/DH, 65 A S/AA, C/DH, 65 A
4 CIL, 2.4 L	1998	6366L 8452L CH-180042 CH-180031	ALT. D.H. MANGUERA INF. MANGUERA SUP.	S/AA, C/DH, 65 A S/AA, C/DH, 65 A
4 CIL, 2.4 L	1997	6366L 8452L	ALT. D.H.	S/AA, C/DH, 65 A S/AA, C/DH, 65 A

**FRONTIER**











V6, 4.0 L	2008	23252 23251 K070873 31115 31836 31336 38378 33940	MANGUERA INF. MANGUERA SUP. SERPENTIN TAPON DE ACEITE TAPON DE GASOLINA TAPONES DE RADIADOR TENSOR TERMOSTATOS	CON LLAVE 16 LIBRAS
4 CIL, 2.5 L	2007	23347 23346 K060815 31115 31838 31836 31336 38378 33940	MANGUERA INF. MANGUERA SUP. SERPENTIN TAPON DE ACEITE TAPON DE GASOLINA TAPON DE GASOLINA TAPON DE RADIADOR TENSOR MICRO-V TERMOSTATO	170°F
V-6, 4.0 L	2007	K060815 31115 31838 31336 K070873 31115 31838 31836 31336 38378 33940	SERPENTIN TAPON DE ACEITE TAPON DE GASOLINA TAPON DE RADIADOR SERPENTIN TAPON DE ACEITE TAPON DE GASOLINA TAPON DE GASOLINA TAPON DE RADIADOR TENSOR MICRO-V TERMOSTATO	SIN LLAVE REGULAR (16 lbs) Sin Palanca
4 CIL, 2.5 L	2006	K060815 31115 31838 31336	SERPENTIN TAPON DE ACEITE TAPON DE GASOLINA TAPON DE RADIADOR	SIN LLAVE REGULAR (16 lbs) Sin Palanca
V-6, 4.0 L	2006	K070873 31115 31838 31336 38378	SERPENTIN TAPON DE ACEITE TAPON DE GASOLINA TAPON DE RADIADOR TENSOR MICRO-V	SIN LLAVE REGULAR (16 lbs) Sin Palanca
4 CIL, 2.5 L	2005	K060815 31115 31838 31336	SERPENTIN TAPON DE ACEITE TAPON DE GASOLINA TAPON DE RADIADOR	SIN LLAVE REGULAR (16 lbs) Sin Palanca
V-6, 4.0 L	2005	K070873 31115 31838 31336	SERPENTIN TAPON DE ACEITE TAPON DE GASOLINA TAPON DE RADIADOR	SIN LLAVE REGULAR (16 lbs) Sin Palanca
4 CIL, 2.4 L	2004	8497 GS 9365 7355 22416 22185 38037 31115 31838 31336 31533 33748	BANDA BANDA BANDA MANG. INF. MANG. SUP. POLEA TAPON DE ACEITE TAPON DE GASOLINA TAPON DE RADIADOR TAPON DE RADIADOR TERMOSTATO	D.H. A.A. ALT. & VENT. RAD A TUBO  D.H.
V-6, 3.3 L	2004	T249 TCK249 22518 22516 22478 22517	BANDA ARBOL DE LEVAS KIT DE DISTRIBUCION MANG. DE PASO MANG. INF. MANG. INF. MANG. SUP.	SIN LLAVE REGULAR (13 lbs) Sin palanca (13 lbs) Con palanca 180°F {133 D x 25.4 mm}
4 CIL, 2.4 L	2000	6366L 8452L CH-180202 CH-180042 CH-180031	ALT. D.H. MANGUERA INF. MANGUERA INF. MANGUERA SUP.	TUBO A TERMOSTATO RAD A TUBO











**ESTACAS - NP300**

4 CIL, 2.4 L	2010	9490L 9365L 6366L	BANDA V BANDA V BANDA V	D.H. COMPRESOR ALTERNADOR
4 CIL, 2.4 L	2009	9490L 9365L 6366L	BANDA V BANDA V BANDA V	D.H. COMPRESOR ALTERNADOR
4 CIL, 2.4 L	2008	9490L 9365L 6366L	BANDA V BANDA V BANDA V	D.H. COMPRESOR ALTERNADOR

**ESTAQUITAS**

4 CIL, 2.4 L	2007	6366L 9365 9455 CH-180202	ALT. COMPRESOR D.H. MANG. INF.	
4 CIL, 2.4 L	2006	6366L 9365 9455 CH-180202	ALT. COMPRESOR D.H. MANG. INF.	
4 CIL, 2.4 L	2005	6366L 9365 9455 CH-180202	ALT. COMPRESOR D.H. MANG. INF.	
4 CIL, 2.4 L	2004	6366L 9365 9455 CH-180202	ALT. COMPRESOR D.H. MANG. INF.	
4 CIL, 2.4 L	2003	6366L 9365 9455 CH-180202	ALT. COMPRESOR D.H. MANG. INF.	
4 CIL, 2.4 L	2002	6366L 9365 9455 CH-180202	ALT. COMPRESOR D.H. MANG. INF.	
4 CIL, 2.4 L	2001	6366L 8452L CH-180202 CH-180042 CH-180031	ALT. D.H. MANGUERA INF. MANGUERA INF. MANGUERA SUP.	S/AA, S/DH S/AA, S/DH
4 CIL, 2.4 L	2000	6366L 8452L CH-180202 CH-180042	ALT. D.H. MANGUERA INF. MANGUERA INF.	S/AA, S/DH

									
V-6, 3.3 L	2004	K060733 K050316 K050486 K040529 31115 31838 31333 31533 T41059 33738	SERPENTIN SERPENTIN SERPENTIN SERPENTIN TAPON DE ACEITE TAPON DE GASOLINA TAPON DE RADIADOR TAPON DE RADIADOR TENSOR ARBOL DE LEVAS TERMOSTATO	AA, C/SUPERCARGADOR ALT. VENT & ALT. AA, S/SUPERCARGADOR SIN LLAVE REGULAR (13 lbs) Sin palanca (13 lbs) Con palanca 180°F	4 CIL, 2.4 L	2001	7306 GS 19212 19213 8497 GS 22416 22185 19607 38037 36116 31115 31838 31836 31533 31333 33738 6362 GS K040529 K040530 K060733 K050316 K050317	A.A. CALEF. A MOTOR CALEF. A TUBO D.H. INF. - RADIADOR A TUBO MANGUERA SUP. PASO POLEA POLEA TAPON DE ACEITE TAPON DE GASOLINA TAPON DE GASOLINA TAPON DE RADIADOR TAPON DE RADIADOR TERMOSTATO VENT & ALT A.A. A.A. A.A. ALT. ALT.	D.H. A.A. SIN LLAVE REGULAR CON LLAVE REGULAR (13 lbs) Sin palanca (13 lbs) Sin palanca 180°F
4 CIL, 2.4 L	2003	7355 9365 8497GS 22416 22185 38037 31115 31838 31333 31533 33748	BANDA ALT. & VENT. BANDA A.A. BANDA D.H. MANG. INF. MANG. SUP. POLEA TAPON DE ACEITE TAPON DE GASOLINA TAPON DE RADIADOR TAPON DE RADIADOR TERMOSTATO	RAD A TUBO D.H. SIN LLAVE REGULAR (13 lbs) Sin palanca (13 lbs) Con palanca 180°F	V-6, 3.3 L	2001	K060733 K050316 K050317 T249 K050486 22478 22516 TCK249 22517 22518 38005 31115 31838 31836 31333 31533 T41059 33738	A.A. A.A. A.A. ALT. ALT. BANDA ARBOL DE LEVAS D.H. INF. - RADIADOR A TUBO INF. - TUBO A TERMOSTATO KIT DE DISTRIBUCION MANGUERA SUP. PASO POLEA TAPON DE ACEITE TAPON DE GASOLINA TAPON DE GASOLINA TAPON DE RADIADOR TAPON DE RADIADOR TAPON DE RADIADOR TENSOR ARBOL DE LEVAS TERMOSTATO	S/Supercargador C/DH C/Supercargador C/AA, C/DH {133 D x 25.4 mm} C/AA, C/DH
V-6, 3.3 L	2003	T249 TCK249 22478 22517 K050316 K060733 K050486 K040529 31115 31838 31533 31333 T41059	BANDA ARBOL DE LEVAS KIT DE DISTRIBUCION MANG. INF. MANG. SUP. SERPENTIN SERPENTIN SERPENTIN SERPENTIN TAPON DE ACEITE TAPON DE GASOLINA TAPON DE RADIADOR TAPON DE RADIADOR TENSOR ARBOL DE LEVAS	{133 D x 25.4 mm} RAD A TUBO ALT. AA, C/SUPERCARGADOR VENT & D.H. AA, S/SUPERCARGADOR SIN LLAVE REGULAR (13 lbs) Con palanca (13 lbs) Sin palanca	V-6, 3.3 L	2003	T249 K050486 22478 22516 TCK249 22517 22518 38005 31115 31838 31836 31333 31533 T41059 33738	BANDA ARBOL DE LEVAS D.H. INF. - RADIADOR A TUBO INF. - TUBO A TERMOSTATO KIT DE DISTRIBUCION MANGUERA SUP. PASO POLEA TAPON DE ACEITE TAPON DE GASOLINA TAPON DE GASOLINA TAPON DE RADIADOR TAPON DE RADIADOR TAPON DE RADIADOR TENSOR ARBOL DE LEVAS TERMOSTATO	C/AA, C/DH {133 D x 25.4 mm} C/AA, C/DH VENTILADOR Y D.H. SIN LLAVE REGULAR CON LLAVE REGULAR (13 lbs) Sin palanca (13 lbs) Con palanca 180°F
4 CIL, 2.4 L	2002	7306 GS 9365 7355 19212 19213 8497 GS 9495 19607 CHARTER 1 22416 22185 38037 31115 31838 31333 31533 33747 6362 GS	A.A. A.A. ALT., VENTILADOR CALEF. A MOTOR CALEF. A TUBO D.H. D.H. MANGUERA DE PASO MANGUERA INF. MANGUERA INF. MANGUERA SUP. POLEA TAPON DE ACEITE TAPON DE GASOLINA TAPON DE RADIADOR TAPON DE RADIADOR TERMOSTATO VENT & ALT	TUBO A MOTOR RADIADOR A TUBO D.H. SIN LLAVE REGULAR (13 lbs) Sin palanca (13 lbs) Con palanca 170°F	4 CIL, 2.4 L	2000	7306 GS 19212 19213 8497 GS 22416 22185 19607 38037 36116 31115 31778 31748 31333 31533 33738 6362 GS K040529 K050316 T249 22478 22516 TCK249 22517 22518 38005 31115 31748 31778 31533 31333 33738	A.A. CALEF. A MOTOR CALEF. A TUBO D.H. INF. - RADIADOR A TUBO MANGUERA SUP. PASO POLEA POLEA TAPON DE ACEITE TAPON DE GASOLINA TAPON DE GASOLINA TAPON DE RADIADOR TAPON DE RADIADOR TAPON DE RADIADOR TERMOSTATO VENT & ALT A.A. ALT. BANDA ARBOL DE LEVAS INF. - RADIADOR A TUBO INF. - TUBO A TERMOSTATO KIT DE DISTRIBUCION MANGUERA SUP. PASO POLEA TAPON DE ACEITE TAPON DE GASOLINA TAPON DE GASOLINA TAPON DE RADIADOR TAPON DE RADIADOR TAPON DE RADIADOR TENSOR ARBOL DE LEVAS TERMOSTATO	D.H. A.A. CON LLAVE REGULAR SIN LLAVE REGULAR (13 lbs) Sin palanca (13 lbs) Con palanca 180°F
V-6, 3.3 L	2002	K040529 K060733 K050316 T249 19203 19203 TCK249 22518 22516 22478 22517 35B 1/2" 18462 31115 31838 31533 31333 T41059 33738 18461 35B 1/2" 18460 K050486	A.A. A.A. ALT. BANDA ARBOL DE LEVAS CALEF. A "T"-1 CALEF. A "T"-2 KIT DE DISTRIBUCION MANGUERA DE PASO MANGUERA INF. MANGUERA INF. MANGUERA SUP. T-1 A TUBO-2 T-2 A TUBO-3 TAPON DE ACEITE TAPON DE GASOLINA TAPON DE RADIADOR TAPON DE RADIADOR TENSOR ARBOL DE LEVAS TERMOSTATO TUBO-2 A TUBO-4 TUBO-5 A VALV. REG. DE AIRE VALV. REG. DE AIRE A MULT. VENTILADOR, D. H.	S/Supercargador C/Supercargador {133 D x 25.4 mm} TUBO A TERMOSTATO RADIADOR A TUBO SIN LLAVE REGULAR (13 lbs) Con palanca (13 lbs) Sin palanca 180°F	V-6, 3.3 L	2000	K040529 K050316 T249 22478 22516 TCK249 22517 22518 38005 31115 31748 31778 31533 31333 33738 6362 GS K040529 K050316 T249 22478 22516 TCK249 22517 22518 38005 31115 31748 31778 31533 31333 33738	A.A. ALT. BANDA ARBOL DE LEVAS INF. - RADIADOR A TUBO INF. - TUBO A TERMOSTATO KIT DE DISTRIBUCION MANGUERA SUP. PASO POLEA TAPON DE ACEITE TAPON DE GASOLINA TAPON DE GASOLINA TAPON DE RADIADOR TAPON DE RADIADOR TAPON DE RADIADOR TENSOR ARBOL DE LEVAS TERMOSTATO VENT & D.H. A.A. CALEF. A MOTOR CALEF. A TUBO D.H. INF. - RADIADOR A TUBO MANGUERA SUP.	{133 D x 25.4 mm} VENTILADOR Y D.H. SIN LLAVE REGULAR CON LLAVE REGULAR (13 lbs) Sin palanca (13 lbs) Sin palanca 180°F
V-6, 3.3 L	1999	7306 GS 19212 19213 8497 GS 22416 22185	A.A. CALEF. A MOTOR CALEF. A TUBO D.H. INF. - RADIADOR A TUBO MANGUERA SUP.	4 CIL, 2.4 L	1999	7306 GS 19212 19213 8497 GS 22416 22185	A.A. CALEF. A MOTOR CALEF. A TUBO D.H. INF. - RADIADOR A TUBO MANGUERA SUP.		

    				    											
4 CIL, 2.4 L	1999	19607	PASO	D.H. A.A.  CON LLAVE REGULAR SIN LLAVE REGULAR (13 lbs) Sin palanca (13 lbs) Con palanca 180°F	V-6, 3.5 L	2007	22964	MANGUERA INF.	D.H. ALTERNADOR Y A.A.						
		38037	POLEA												
		36116	POLEA												
		31115	TAPON DE ACEITE												
		31778	TAPON DE GASOLINA												
		31748	TAPON DE GASOLINA												
		31333	TAPON DE RADIADOR												
		31533	TAPON DE RADIADOR												
		33738	TERMOSTATO												
		6362 GS	VENT & ALT												
		V-6, 3.3 L	1999				K040529	A.A.		{133 D x 25.4 mm}	V-6, 3.5 L	2006	22964	MANG. INF.	ALT. & A.A. D.H.
							K050316	ALT.							
							T249	BANDA ARBOL DE LEVAS							
							22478	INF. - RADIADOR A TUBO							
22516	INF. - TUBO A TERMOSTATO														
TCK249	KIT DE DISTRIBUCION														
22517	MANGUERA SUP.														
22518	PASO														
38005	POLEA			VENTILADOR Y D.H.											
31115	TAPON DE ACEITE			SIN LLAVE REGULAR											
4 CIL, 2.4 L	2001	6366L	ALT.	C/AA C/AA C/AA, C/DH C/AA, C/DH C/AA C/AA C/AA, C/DH C/AA, C/DH C/AA C/AA C/AA, C/DH C/AA, C/DH C/AA C/AA, C/DH C/AA, C/DH C/AA C/AA, C/DH C/AA, C/DH C/AA C/AA	V-6, 3.0 L	2004	T104	BANDA ARBOL DE LEVAS	SOHC SOHC PRES. DESDE LA BOMBA, DC DOHC SOHC DOHC SOHC B.A. & D.H. SOHC B.A. & D.H. SOHC A.A. ALT. SOHC ALT. DOHC B.A. & D.H. DOHC						
		8452L	D.H.												
		CH-180042	MANGUERA INF.												
		CH-180031	MANGUERA SUP.												
		6366L	ALT.												
		8452L	D.H.												
		CH-180042	MANGUERA INF.												
		CH-180031	MANGUERA SUP.												
		6366L	ALT.												
		8452L	D.H.												
		CH-180042	MANGUERA INF.												
		CH-180031	MANGUERA SUP.												
		6366L	ALT.												
		8452L	D.H.												
4 CIL, 2.0 L	1998	K060408	ALT.	C/AA	V-6, 3.5 L	2004	22970	MANG. INF.	ALT. & A.A. D.H. ALT. & A.A.						
		K040335	D.H.												
		31115	TAPON DE ACEITE												
V-6, 3.5 L	2009	19810	MANGUERA CALEFACCION	LADO DER. LADO IZQ. TUBO A MOTOR RADIADOR AL TUBO RADIADOR AL TANQUE TANQUE A MOTOR	V-6, 3.5 L	2003	22970	MANG. INF.	ALT. Y A.A. D.H. ALT. & A.A.						
		19722	MANGUERA CALEFACCION												
		23352	MANGUERA INF.												
		23351	MANGUERA INF.												
		23353	MANGUERA SUP.												
		23350	MANGUERA SUP.												
		K070669	SERPENTIN												
		31115	TAPON DE ACEITE												
		31838	TAPON DE GASOLINA												
		31836	TAPON DE GASOLINA												
		31551	TAPONES DE RADIADOR												
		V-6, 3.5 L	2008				22964	MANGUERA INF.		CON LLAVE 20LBS.	V-6, 3.5 L	2002	K060431	ALT., A.A.	ALT. Y A.A.
							22963	MANGUERA SUP.							
							K040305	SERPENTIN							
K060418	SERPENTIN														
31115	TAPON DE ACEITE														
31836	TAPON DE GASOLINA														
31838	TAPON DE GASOLINA														
31551	TAPONES DE RADIADOR														
20LBS.															
20LBS.															
V-6, 3.5 L	2001	19810	MANGUERA CALEFACCION	LADO DER. LADO IZQ. TUBO A MOTOR RADIADOR AL TUBO RADIADOR AL TANQUE TANQUE A MOTOR	V-6, 3.5 L	2003	22970	MANG. INF.	ALT. Y A.A. D.H. ALT. & A.A.						
		19722	MANGUERA CALEFACCION												
		23352	MANGUERA INF.												
		23351	MANGUERA INF.												
		23353	MANGUERA SUP.												
		23350	MANGUERA SUP.												
		K070669	SERPENTIN												
		31115	TAPON DE ACEITE												
		31838	TAPON DE GASOLINA												
		31836	TAPON DE GASOLINA												
		31551	TAPONES DE RADIADOR												
		V-6, 3.5 L	2008				22964	MANGUERA INF.		CON LLAVE 20LBS.	V-6, 3.5 L	2002	K060431	ALT., A.A.	ALT. Y A.A.
							22963	MANGUERA SUP.							
							K040305	SERPENTIN							
K060418	SERPENTIN														
31115	TAPON DE ACEITE														
31836	TAPON DE GASOLINA														
31838	TAPON DE GASOLINA														
31551	TAPONES DE RADIADOR														
20LBS.															
20LBS.															
V-6, 3.5 L	2001	19810	MANGUERA CALEFACCION	LADO DER. LADO IZQ. TUBO A MOTOR RADIADOR AL TUBO RADIADOR AL TANQUE TANQUE A MOTOR	V-6, 3.5 L	2003	22970	MANG. INF.	ALT. Y A.A. D.H. ALT. & A.A.						
		19722	MANGUERA CALEFACCION												
		23352	MANGUERA INF.												
		23351	MANGUERA INF.												
		23353	MANGUERA SUP.												
		23350	MANGUERA SUP.												
		K070669	SERPENTIN												
		31115	TAPON DE ACEITE												
		31838	TAPON DE GASOLINA												
		31836	TAPON DE GASOLINA												
		31551	TAPONES DE RADIADOR												
		V-6, 3.5 L	2008				22964	MANGUERA INF.		CON LLAVE 20LBS.	V-6, 3.5 L	2002	K060431	ALT., A.A.	ALT. Y A.A.
							22963	MANGUERA SUP.							
							K040305	SERPENTIN							
K060418	SERPENTIN														
31115	TAPON DE ACEITE														
31836	TAPON DE GASOLINA														
31838	TAPON DE GASOLINA														
31551	TAPONES DE RADIADOR														
20LBS.															
20LBS.															

**KING CAB**

**LUCCINO**

**MAXIMA**

V-6, 3.0 L	2001	K040305 92037 22184 22183 31115 31615 31748 31778 31832 31333 31533 33912 22519	D.H. EDH MANGUERA INF. MANGUERA SUP. TAPON DE ACEITE TAPON DE GASOLINA TAPON DE GASOLINA TAPON DE GASOLINA TAPON DE GASOLINA TAPON DE RADIADOR TAPON DE RADIADOR TAPON DE RADIADOR TERMOSTATO TERMOSTATO A MOTOR	PRESION 4 CIL, 1.4 L SIN LLAVE C/CONT. DE EMIS 4 CIL, 1.4 L CON LLAVE REGULAR CON LLAVE REGULAR SIN LLAVE REGULAR (13 lbs) Sin palanca (13 lbs) Con palanca 180°F
V-6, 3.0 L	2000	K060435 K060433 K040305 92037 28474 22184 22183 31115 31778 31734 31748 31615 31533 31333 33912 22519	ALT & A.A. ALT. D.H. EDH MANGUERA DE PASO MANGUERA INF. MANGUERA SUP. TAPON DE ACEITE TAPON DE GASOLINA TAPON DE GASOLINA TAPON DE GASOLINA TAPON DE GASOLINA TAPON DE RADIADOR TAPON DE RADIADOR TERMOSTATO TERMOSTATO A MOTOR	PRESION V-6, 3.5 L CON LLAVE REGULAR CON LLAVE C/CONT. DE EMIS SIN LLAVE REGULAR SIN LLAVE C/CONT. DE EMIS (13 lbs) Con palanca (13 lbs) Sin palanca 180°F
V-6, 3.0 L	1999	K060431 K060433 19756 K040305 92037 28474 22184 22183 31115 31615 31778 31748 31734 31533 31333 33912	ALT & A.A. ALT. CALEF. A TUBO-1 D.H. EDH MANGUERA DE PASO MANGUERA INF. MANGUERA SUP. TAPON DE ACEITE TAPON DE GASOLINA TAPON DE GASOLINA TAPON DE GASOLINA TAPON DE GASOLINA TAPON DE RADIADOR TAPON DE RADIADOR TERMOSTATO	PRESION V-6, 3.5 L SIN LLAVE C/CONT. DE EMIS CON LLAVE REGULAR SIN LLAVE REGULAR CON LLAVE C/CONT. DE EMIS (13 lbs) Con palanca (13 lbs) Sin palanca 180°F
V-6, 3.0 L	1998	K060427 K040305 80101 28474 22184 22183 31115 31748 31333 31533 33912	ALT. D.H. EDH MANGUERA DE PASO MANGUERA INF. MANGUERA SUP. TAPON DE ACEITE TAPON DE GASOLINA TAPON DE RADIADOR TAPON DE RADIADOR TAPON DE RADIADOR TERMOSTATO	PRESION 6 CIL, 3.5 L SIN LLAVE REGULAR (13 lbs) Sin palanca (13 lbs) Con palanca 180°F
V-6, 3.0 L	1997	K060427 K040305 80101 22184 22183 31115 31748 31533 31333 33912	ALT. D.H. EDH MANG. INF. MANG. SUP. TAPON DE ACEITE TAPON DE GASOLINA TAPON DE RADIADOR TAPON DE RADIADOR TERMOSTATO	PRESION C/DOHC V-6, 3.5 L SIN LLAVE REGULAR (13 lbs) Con palanca (13 lbs) Sin palanca 180°F

	2006	K040328 K040420 K030267	ALT. ALT. B.A.	SIN A.A. CON A.A.
	2005	K040420 K040328 K030267	ALT. ALT. B.A.	CON A.A. SIN A.A.
	2004	K040328 K040420 K030267	ALT. ALT. B.A.	SIN A.A. CON A.A.

**MURANO**

V-6, 3.5 L	2010	23406 20776 K070669 31115 31838 31836 31551 33951	MANGUERA INF. MANGUERA SUP. SERPENTIN TAPON DE ACEITE TAPON DE GASOLINA TAPON DE GASOLINA TAPONES DE RADIADOR TERMOSTATOS	RADIADOR A TUBO RADIADOR A TANQUE CON LLAVE 20LBS. 180°
V-6, 3.5 L	2009	23406 20776 K070673 31115 31836 31838 31551 33951	MANGUERA INF. MANGUERA SUP. SERPENTIN TAPON DE ACEITE TAPON DE GASOLINA TAPON DE GASOLINA TAPONES DE RADIADOR TERMOSTATOS	RADIADOR A TUBO CON LLAVE 20LBS. 180°
V-6, 3.5 L	2008	23288 23289 K060420 K040305 31115 31838 31836 31333 14778	MANGUERA INF. MANGUERA SUP. SERPENTIN SERPENTIN TAPON DE ACEITE TAPON DE GASOLINA TAPON DE GASOLINA TAPONES DE RADIADOR TERMOSTATOS	ALTERNADOR Y A.A. D.H. CON LLAVE
V-6, 3.5 L	2007	23288 23289 K040305 K060420 31115 31838 31836 31333 14778	MANGUERA INF. MANGUERA SUP. SERPENTIN SERPENTIN TAPON DE ACEITE TAPON DE GASOLINA TAPON DE GASOLINA TAPON DE RADIADOR TERMOSTATO	D.H. ALTERNADOR Y A.A. CON LLAVE 180°F
V-6, 3.5 L	2006	36087 K060418 K040305 31115 31838 31333 31533 14778	POLEA SERPENTIN SERPENTIN TAPON DE ACEITE TAPON DE GASOLINA TAPON DE RADIADOR TAPON DE RADIADOR TERMOSTATO	ALT. & A.A. D.H. SIN LLAVE REGULAR (13 lbs) Sin palanca (13 lbs) Con palanca 180°F
V-6, 3.5 L	2006	23288 23289	MANGUERA INF. MANGUERA SUP.	
V-6, 3.5 L	2005	K060418 K040305 31115 31838 31533 31333 14778	SERPENTIN SERPENTIN TAPON DE ACEITE TAPON DE GASOLINA TAPON DE RADIADOR TAPON DE RADIADOR TERMOSTATO	ALT. & A.A. D.H. SIN LLAVE REGULAR (13 lbs) Con palanca (13 lbs) Sin palanca 180°F
V-6, 3.5 L	2005	23288 23289	MANGUERA INF. MANGUERA SUP.	
V-6, 3.5 L	2004	22535 22534 K060418 K040305 31115 31838 31533 31333 14778	MANGUERA INF. MANGUERA SUP. SERPENTIN SERPENTIN TAPON DE ACEITE TAPON DE GASOLINA TAPON DE RADIADOR TAPON DE RADIADOR TERMOSTATO	ALT. & A.A. D.H. SIN LLAVE REGULAR (13 lbs) Con palanca (13 lbs) Sin palanca 180°F
V-6, 3.5 L	2004	36087	POLEA	ALT. Y A.A.

**MICRA**

4 CIL, 1.4 L	2008	K040328 K040420 K030267	ALT. ALT. B.A.	SIN A.A. CON A.A.
4 CIL, 1.4 L	2007	K040420 K040328 K030267	ALT. ALT. B.A.	CON A.A. SIN A.A.



V-6, 3.5 L		2003 36087		POLEA	ALT. Y A.A.	V-6, 3.5 L		2001		31838 TAPON DE GASOLINA		SIN LLAVE REGULAR
<b>PATHFINDER</b>												
V-6, 4.0 L	2010	23252	MANGUERA INF.			V-6, 3.5 L	2001	31333	TAPON DE RADIADOR	(13 lbs) Sin palanca		
		23251	MANGUERA SUP.					31533	TAPON DE RADIADOR	(13 lbs) Con palanca		
		36222	POLEA					33940	TERMOSTATO	170°F		
		K070873	SERPENTIN					19769	TUBO-1 A CALEF.			
		31115	TAPON DE ACEITE					19770	TUBO-3 A TUBO-4			
		31838	TAPON DE GASOLINA					30T 3/4"	TUBO-5 A TUBO-1			
		31836	TAPON DE GASOLINA	CON LLAVE				K040372	A.A.	C/DH		
		38378	TENSOR					K060465	ALT.	C/AA, C/DH		
		34041	TERMOSTATOS	180°				19768	CALEF. A TUBO-3			
V-6, 4.0 L	2009	23252	MANGUERA INF.					22532	MANGUERA INF.			
		23251	MANGUERA SUP.					22531	MANGUERA SUP.			
		36222	POLEA					31115	TAPON DE ACEITE			
		K070873	SERPENTIN					31838	TAPON DE GASOLINA	SIN LLAVE REGULAR		
		31115	TAPON DE ACEITE					31836	TAPON DE GASOLINA	CON LLAVE REGULAR		
		31838	TAPON DE GASOLINA					31533	TAPON DE RADIADOR	(13 lbs) Con palanca		
		31836	TAPON DE GASOLINA	CON LLAVE		V-6, 3.3 L	2000	31333	TAPON DE RADIADOR	(13 lbs) Sin palanca		
		38378	TENSOR					33940	TERMOSTATO	170°F		
		34041	TERMOSTATOS	180°				19769	TUBO-1 A CALEF.			
V-6, 4.0 L	2008	23252	MANGUERA INF.					K050505	A.A.	C/DH		
		23251	MANGUERA SUP.					K060420	ALT.	C/AA, C/DH		
		36222	POLEA					T249	BANDA ARBOL DE LEVAS	{133 D x 25.4 mm}		
		K070873	SERPENTIN					19752	CALEF. A "T"-1			
		31115	TAPON DE ACEITE					19751	CALEF. A "T"-2			
		31838	TAPON DE GASOLINA					9350	D.H.			
		31836	TAPON DE GASOLINA	CON LLAVE				22276	INF. - MOTOR A TUBO			
		38378	TENSOR					22275	INF. - TUBO A RADIADOR			
		34041	TERMOSTATOS	180°				TCK249	KIT DE DISTRIBUCION			
V-6, 4.0 L	2007	23252	MANGUERA INF.					20940	MANGUERA SUP.			
		23251	MANGUERA SUP.					22518	PASO			
		K070873	SERPENTIN					31115	TAPON DE ACEITE			
		31115	TAPON DE ACEITE					31748	TAPON DE GASOLINA	SIN LLAVE REGULAR		
		31838	TAPON DE GASOLINA					31615	TAPON DE GASOLINA	SIN LLAVE C/CONT. DE EMIS		
		31836	TAPON DE GASOLINA	CON LLAVE				31734	TAPON DE GASOLINA	CON LLAVE C/CONT. DE EMIS		
		31336	TAPON DE RADIADOR					31778	TAPON DE GASOLINA	CON LLAVE REGULAR		
		38378	TENSOR MICRO-V					31533	TAPON DE RADIADOR	(13 lbs) Con palanca		
		33940	TERMOSTATO	170°F				31333	TAPON DE RADIADOR	(13 lbs) Sin palanca		
V-6, 4.0 L	2006	K070873	SERPENTIN			V-6, 3.3 L	1999	T41059	TENSOR ARBOL DE LEVAS			
		31115	TAPON DE ACEITE					33737	TERMOSTATO	170°F		
		31838	TAPON DE GASOLINA	SIN LLAVE REGULAR				K050505	A.A.	C/DH		
		31336	TAPON DE RADIADOR	(16 lbs) Sin Palanca				K060420	ALT.	C/AA, C/DH		
		38378	TENSOR MICRO-V					T249	BANDA ARBOL DE LEVAS	{133 D x 25.4 mm}		
		33940	TERMOSTATO	170°F				19752	CALEF. A "T"-1			
V-6, 4.0 L	2005	K070873	SERPENTIN					19751	CALEF. A "T"-2			
		31115	TAPON DE ACEITE					22276	INF. - MOTOR A TUBO			
		31838	TAPON DE GASOLINA	SIN LLAVE REGULAR				22275	INF. - TUBO A RADIADOR			
		31336	TAPON DE RADIADOR	(16 lbs) Sin Palanca				TCK249	KIT DE DISTRIBUCION			
		38378	TENSOR MICRO-V					20940	MANGUERA SUP.			
		33940	TERMOSTATO	170°F				22518	PASO			
V-6, 3.5 L	2004	22532	MANG. INF.					31115	TAPON DE ACEITE			
		22531	MANG. SUP.					31748	TAPON DE GASOLINA	SIN LLAVE REGULAR		
		K040372	SERPENTIN					31615	TAPON DE GASOLINA	SIN LLAVE C/CONT. DE EMIS		
		K060465	SERPENTIN	A.A.				31778	TAPON DE GASOLINA	CON LLAVE REGULAR		
		31115	TAPON DE ACEITE	VENT & ALT. & D.H.				31734	TAPON DE GASOLINA	CON LLAVE C/CONT. DE EMIS		
		31838	TAPON DE GASOLINA	SIN LLAVE REGULAR				31333	TAPON DE RADIADOR	(13 lbs) Sin palanca		
		31533	TAPON DE RADIADOR	(13 lbs) Con palanca				31533	TAPON DE RADIADOR	(13 lbs) Con palanca		
		31333	TAPON DE RADIADOR	(13 lbs) Sin palanca		V-6, 3.0 L	1998	T41059	TENSOR ARBOL DE LEVAS			
V-6, 3.5 L	2003	22532	MANG. INF.					33737	TERMOSTATO	170°F		
		22531	MANG. SUP.					33737	TERMOSTATO	170°F		
		K040372	SERPENTIN	A.A.				BDH-5155	BOMBA DE DIR. HIDR.			
		K060465	SERPENTIN	ALT. & D.H.				31115	TAPON DE ACEITE			
		31115	TAPON DE ACEITE					33737	TERMOSTATO	170°F		
		31838	TAPON DE GASOLINA	SIN LLAVE REGULAR				33737	TERMOSTATO	170°F		
		31533	TAPON DE RADIADOR	(13 lbs) Con palanca				K050505	A.A.	C/DH		
		31333	TAPON DE RADIADOR	(13 lbs) Sin palanca		V-6, 3.3 L	1998	K060420	ALT.	C/AA, C/DH		
V-6, 3.5 L	2002	K040372	A.A.					T249	BANDA ARBOL DE LEVAS	{133 D x 25.4 mm}		
		K060465	ALT., D.H.					BDH-5155	BOMBA DE DIR. HIDR.			
		19768	CALEF. A TUBO-3					8354 GS	D.H.	C/AA, C/DH		
		22532	MANGUERA INF.					TCK249	KIT DE DISTRIBUCION			
		22531	MANGUERA SUP.					22276	MANG. INF.	MOTOR A TUBO		
		31115	TAPON DE ACEITE					22275	MANG. INF.	TUBO A RAD		
		31836	TAPON DE GASOLINA	CON LLAVE REGULAR				20940	MANG. SUP.			
								31115	TAPON DE ACEITE			
								31748	TAPON DE GASOLINA	SIN LLAVE REGULAR		
								31333	TAPON DE RADIADOR	(13 lbs) Sin palanca		

V-6, 3.3 L	1998	31533 T41059 33737	TAPON DE RADIADOR TENSOR ARBOL DE LEVAS TERMOSTATO
V-6, 3.5 L	1998	BDH-5155	BOMBA DE DIR. HIDR.
V-6, 3.0 L	1997	BDH-5155 31115 33737 33737	BOMBA DE DIR. HIDR. TAPON DE ACEITE TERMOSTATO TERMOSTATO
V-6, 3.3 L	1997	BDH-5155 TCK249 31115 T41059	BOMBA DE DIR. HIDR. KIT DE DISTRIBUCION TAPON DE ACEITE TENSOR ARBOL DE LEVAS
V-6, 3.5 L	1997	BDH-5155 31115	BOMBA DE DIR. HIDR. TAPON DE ACEITE

4 CIL, 2.4 L	1997	CH-180202 6366L BDH-5155 8452L	MANGUERA INF. ALT. BOMBA DE DIR. HIDR. D.H.
		CH-180202 38036 33747 33747	MANGUERA INF. POLEA TERMOSTATO TERMOSTATO

**PATHFINDER LE 4X2**

V-6, 3.3 L	2000	20568 22275 20940 K060465 K040372	MANGUERA DE PASO MANGUERA INF. MANGUERA SUP. SERPENTIN SERPENTIN
V-6, 3.3 L	1999	20568 22275 20940 K040372 K060465	MANGUERA DE PASO MANGUERA INF. MANGUERA SUP. SERPENTIN SERPENTIN
V-6, 3.3 L	1998	20568 22275 20940 K040372 K060465	MANGUERA DE PASO MANGUERA INF. MANGUERA SUP. SERPENTIN SERPENTIN
V-6, 3.3 L	1997	20568 22275 20940 K040372 K060465	MANGUERA DE PASO MANGUERA INF. MANGUERA SUP. SERPENTIN SERPENTIN

**PICK-UP - NP300**

4 CIL, 2.4 L	2010	6366L 9365L 9490L	BANDA V BANDA V BANDA V	ALTERNADOR COMPRESOR D.H.
4 CIL, 2.4 L	2009	6366L 9490L 9365L	BANDA V BANDA V BANDA V	ALTERNADOR D.H. COMPRESOR
4 CIL, 2.4 L	2008	9490L 9365L 6366L	BANDA V BANDA V BANDA V	D.H. COMPRESOR ALTERNADOR

**PICK-UP DOBLE CABINA**











4 CIL, 2.4 L	2001	6366L 8452L CH-180042 CH-180031	ALT. D.H. MANGUERA INF. MANGUERA SUP.	S/AA, C/DH, 65 A S/AA, C/DH, 65 A C/AA, C/DH C/AA, C/DH
4 CIL, 2.4 L	2000	6366L 8452L CH-180042 CH-180031	ALT. D.H. MANGUERA INF. MANGUERA SUP.	S/AA, C/DH, 65 A S/AA, C/DH, 65 A C/AA, C/DH C/AA, C/DH
4 CIL, 2.4 L	1999	6366L 8452L CH-180042 CH-180031	ALT. D.H. MANGUERA INF. MANGUERA SUP.	S/AA, C/DH, 65 A S/AA, C/DH, 65 A C/AA, C/DH C/AA, C/DH
4 CIL, 2.4 L	1998	6366L 8452L CH-180042 CH-180031	ALT. D.H. MANGUERA INF. MANGUERA SUP.	S/AA, C/DH, 65 A S/AA, C/DH, 65 A C/AA, C/DH C/AA, C/DH
4 CIL, 2.4 L	1997	6366L 8452L	ALT. D.H.	S/AA, C/DH, 65 A S/AA, C/DH, 65 A

**PICK-UP**

4 CIL, 2.4 L	2007	6366L 9365 9455 CH-180202	ALT. COMPRESOR D.H. MANGUERA INF.
4 CIL, 2.4 L	2006	6366L 9365 9455 CH-180202	ALT. COMPRESOR D.H. MANGUERA INF.
4 CIL, 2.4 L	2005	6366L 9365 9455 CH-180202	ALT. COMPRESOR D.H. MANGUERA INF.
4 CIL, 2.4 L	2004	6366L 9365 9455 CH-180202	ALT. COMPRESOR D.H. MANGUERA INF.
4 CIL, 2.4 L	2003	6366L 9365 9455 CH-180202	ALT. COMPRESOR D.H. MANGUERA INF.
4 CIL, 2.4 L	2002	6366L 9365 9455 CH-180202	ALT. COMPRESOR D.H. MANGUERA INF.
4 CIL, 2.4 L	2001	6366L 8452L CH-180202	BANDA ALT. BANDA D.H. MANGUERA INF.
4 CIL, 2.4 L	2000	6366L 8452L CH-180202	ALT. D.H. MANGUERA INF.
4 CIL, 2.4 L	1999	6366L 8452L CH-180202	ALT. D.H. MANGUERA INF.
4 CIL, 2.4 L	1998	6366L 8452L	ALT. D.H.

**PLATINA**

4 CIL, 1.6 L	2010	T1095 TCK1095 CH-180182 CH-180191 T41237 K050688 K050435 T38484 T38456 T43064 TH23389G1	BANDA ARBOL DE LEVAS KIT DE DISTRIBUCION MANGUERA INF. MANGUERA SUP. POLEA DE DISTRIBUCION SERPENTIN SERPENTIN TENSOR TENSOR TENSOR TERMOSTATOS	132 D X 27MM
4 CIL, 1.6 L	2009	T1095 TCK1095 CH-180182 CH-180191 T41237 K050435 K050688 T43064 T38484 T38456 TH23389G1	BANDA ARBOL DE LEVAS KIT DE DISTRIBUCION MANGUERA INF. MANGUERA SUP. POLEA DE DISTRIBUCION SERPENTIN SERPENTIN TENSOR TENSOR TENSOR TERMOSTATOS	132 D X 27MM
4 CIL, 1.6 L	2008	T1095 TCK1095 CH-180182 CH-180191 T41237 K050688 K050435 T38456 T38484 T43064	BANDA ARBOL DE LEVAS KIT DE DISTRIBUCION MANGUERA INF. MANGUERA SUP. POLEA DE DISTRIBUCION SERPENTIN SERPENTIN TENSOR TENSOR TENSOR TENSOR ARBOL DE LEVAS	{132 D x 27 mm}

    				    					
4 CIL, 1.6 L	2008	TH23389G1	TERMOSTATO	190°F			31838	TAPON DE GASOLINA	
4 CIL, 1.6 L	2007	T1095	BANDA ARBOL DE LEVAS	{132 D x 27 mm}			31534	TAPONES DE RADIADOR	16 LBS.
		TCK1095	KIT DE DISTRIBUCION				36087	TENSOR	
		CH-180182	MANGUERA INF.		V-6, 3.5 L		22964	MANGUERA INF.	
		CH-180191	MANGUERA SUP.			2008	23288	MANGUERA SUP.	
		T41237	POLEA DE DISTRIBUCION				K040305	SERPENTIN	D.H.
		K050435	SERPENTIN	SIN A.A.			K060418	SERPENTIN	ALT. / A.A.
		K050688	SERPENTIN	CON A.A.			31115	TAPON DE ACEITE	
		T38484	TENSOR	SIN A.A.			31836	TAPON DE GASOLINA	CON LLAVE
		T38456	TENSOR	CON A.A.			31838	TAPON DE GASOLINA	
		T43064	TENSOR ARBOL DE LEVAS				31534	TAPONES DE RADIADOR	16 LBS.
4 CIL, 1.6 L	2006	TH23389G1	TERMOSTATO	190°F			36087	TENSOR	
		T1095	BANDA ARBOL DE LEVAS	{132 D x 27 mm}	V-6, 3.5 L	2007	22964	MANGUERA INF.	
		TCK1095	KIT DE DISTRIBUCION				36087	POLEA	
		CH-180182	MANG. INF.				K060418	SERPENTIN	ALTERNADOR Y A.A.
		CH-180191	MANG. SUP.				K040305	SERPENTIN	D.H.
		T41237	POLEA DE DISTRIBUCION				31115	TAPON DE ACEITE	
		K050688	SERPENTIN	C/AA			31836	TAPON DE GASOLINA	CON LLAVE
		K050435	SERPENTIN				31838	TAPON DE GASOLINA	
		T38456	TENSOR	CON A.A.			31333	TAPON DE RADIADOR	
		T38484	TENSOR	SIN A.A.			33951	TERMOSTATO	180 °F
		T43064	TENSOR ARBOL DE LEVAS		6 CIL, 3.5 L	2006	36087	POLEA LOCA	ALT. & A.A.
4 CIL, 1.6 L	2005	TH23389G1	TERMOSTATO	190°F			K040305	SERPENTIN	D.H.
		T1095	BANDA ARBOL DE LEVAS	{132 D x 27 mm}			K060418	SERPENTIN	ALT. & A.A.
		TCK1095	KIT DE DISTRIBUCION				31115	TAPON DE ACEITE	
		CH-180182	MANG. INF.				31533	TAPON DE RADIADOR	(13 lbs) Con palanca
		CH-180191	MANGUERA SUP.				31333	TAPON DE RADIADOR	(13 lbs) Sin palanca
		T41237	POLEA DE DISTRIBUCION				33951	TERMOSTATO	180°F
		K050688	SERPENTIN	C/AA	6 CIL, 3.5 L	2005	K060418	SERPENTIN	ALT. & A.A.
		T38484	TENSOR	SIN A.A.			K040305	SERPENTIN	D.H.
		T38456	TENSOR	CON A.A.			31115	TAPON DE ACEITE	
		T43064	TENSOR ARBOL DE LEVAS				31838	TAPON DE GASOLINA	SIN LLAVE REGULAR
4 CIL, 1.6 L	2004	TH23389G1	TERMOSTATO	190°F			31533	TAPON DE RADIADOR	(13 lbs) Con palanca
		T1095	BANDA ARBOL DE LEVAS	{132 D x 27 mm}			31333	TAPON DE RADIADOR	(13 lbs) Sin palanca
		TCK1095	KIT DE DISTRIBUCION		6 CIL, 3.5 L	2004	33951	TERMOSTATO	180°F
		CH-180182	MANG. INF.				K060418	SERPENTIN	ALT. & A.A.
		CH-180191	MANGUERA SUP.				K040305	SERPENTIN	D.H.
		T41237	POLEA DE DISTRIBUCION				31115	TAPON DE ACEITE	
		K050435	SERPENTIN	S/AA			31836	TAPON DE GASOLINA	CON LLAVE REGULAR
		K050688	SERPENTIN	C/AA			31533	TAPON DE RADIADOR	(13 lbs) Con palanca
		T38484	TENSOR	SIN A.A.			31333	TAPON DE RADIADOR	(13 lbs) Sin palanca
		T38456	TENSOR	CON A.A.			33951	TERMOSTATO	180°F
		T43064	TENSOR ARBOL DE LEVAS		6 CIL, 3.5 L	2003	K040305	SERPENTIN	ALT.
4 CIL, 1.6 L	2003	TH23389G1	TERMOSTATO	190°F			T249	BANDA ARBOL DE LEVAS	{133 D x 25.4 mm}
		T1095	BANDA ARBOL DE LEVAS	{132 D x 27 mm}	6 CIL, 3.3 L	2002	92014	EDH	PRES. A LA CAJA DE DIR
		TCK1095	KIT DE DISTRIBUCION				TCK249	KIT DE DISTRIBUCION	
		CH-180182	MANG. INF.				22063	MANG. DE PASO	
		CH-180191	MANGUERA SUP.				22147	MANG. INF.	
		T41237	POLEA DE DISTRIBUCION				22028	MANG. SUP.	
		K050435	SERPENTIN	S/AA			K040460	SERPENTIN	A.A.
		K050688	SERPENTIN	C/AA			K040405	SERPENTIN	B.A. & D.H.
		T38456	TENSOR	CON A.A.			K050335	SERPENTIN	ALT.
		T38484	TENSOR	SIN A.A.			31115	TAPON DE ACEITE	
		T43064	TENSOR ARBOL DE LEVAS				31533	TAPON DE RADIADOR	(13 lbs) Con palanca
4 CIL, 1.6 L	2002	TH23389G1	TERMOSTATO	190°F			31333	TAPON DE RADIADOR	(13 lbs) Sin palanca
		T1095	BANDA ARBOL DE LEVAS	{132 D x 27 mm}			33738	TERMOSTATO	180°F
		TCK1095	KIT DE DISTRIBUCION		V-6, 3.3 L	2001	K040460	A.A.	
		CH-180191	MANG. INF.				K050335	ALT.	
		CH-180182	MANG. INF.				K040405	BA Y D.H.	
		T41237	POLEA DE DISTRIBUCION				T249	BANDA ARBOL DE LEVAS	{133 D x 25.4 mm}
		K050435	SERPENTIN	S/AA			92014	EDH	PRES. A LA CAJA DE DIR
		K050688	SERPENTIN	C/AA			TCK249	KIT DE DISTRIBUCION	
		T38484	TENSOR	SIN A.A.			22147	MANGUERA INF.	
		T38456	TENSOR	CON A.A.			22028	MANGUERA SUP.	
		T43064	TENSOR ARBOL DE LEVAS				22063	PASO	
		TH23389G1	TERMOSTATO	190°F			31115	TAPON DE ACEITE	
							31836	TAPON DE GASOLINA	CON LLAVE REGULAR
							31533	TAPON DE RADIADOR	(13 lbs) Con palanca
							31333	TAPON DE RADIADOR	(13 lbs) Sin palanca
							T41059	TENSOR ARBOL DE LEVAS	
							33738	TERMOSTATO	180°F
							33737	TERMOSTATO	170°F
							K040470	A.A.	C/DH
							K040460	A.A.	
							K050336	ALT.	C/AA, C/DH

**QUEST**

V-6, 3.5 L	2009	22964	MANGUERA INF.						
		23288	MANGUERA SUP.						
		K060418	SERPENTIN	ALT. / A.A.					
		K040305	SERPENTIN	D.H.					
		31115	TAPON DE ACEITE		V-6, 3.3 L	2000	K040470	A.A.	
		31836	TAPON DE GASOLINA	CON LLAVE			K040460	A.A.	
							K050336	ALT.	













V-6, 3.3 L	2000	K050335 T249 BDH-5155 K040405 92014 TCK249 22147 22028 22063 38044 31115 31836 31333 31533 T41059 33737 33738	ALT. BANDA ARBOL DE LEVAS BOMBA DE DIR. HIDR. D.H. EDH KIT DE DISTRIBUCION MANGUERA INF. MANGUERA SUP. PASO POLEA TAPON DE ACEITE TAPON DE GASOLINA TAPON DE RADIADOR TAPON DE RADIADOR TENSOR ARBOL DE LEVAS TERMOSTATO TERMOSTATO	{133 D x 25.4 mm}  C/AA, C/DH PRES. A LA CAJA DE DIR   A.A.  CON LLAVE REGULAR (13 lbs) Sin palanca (13 lbs) Con palanca  170°F 180°F C/DH	4 CIL, 2.5 L
V-6, 3.3 L	1999	K040470 K040460 K050335 K050336 T249 K040405 92014 TCK249 22147 22028 22063 38044 31115 31778 31533 31333 T41059 33737 33737	A.A. A.A. ALT. ALT. BANDA ARBOL DE LEVAS D.H. EDH KIT DE DISTRIBUCION MANGUERA INF. MANGUERA SUP. PASO POLEA TAPON DE ACEITE TAPON DE GASOLINA TAPON DE RADIADOR TAPON DE RADIADOR TENSOR ARBOL DE LEVAS TERMOSTATO TERMOSTATO	C/AA, C/DH {133 D x 25.4 mm} C/AA, C/DH PRES. A LA CAJA DE DIR   A.A.  CON LLAVE REGULAR (13 lbs) Con palanca (13 lbs) Sin palanca  170°F 170°F C/AA, C/DH {133 D x 25.4 mm} PRES. A LA CAJA DE DIR	4 CIL, 2.5 L
V-6, 3.0 L	1998	K040470 T249 92014 TCK249 22063 22147 22028 38044 K040460 K050336 K040405 31115 31748 31333 31533 T41059 33737	BANDA A.A. BANDA ARBOL DE LEVAS EDH KIT DE DISTRIBUCION MANGUERA DE PASO MANGUERA INF. MANGUERA SUP. POLEA SERPENTIN SERPENTIN SERPENTIN TAPON DE ACEITE TAPON DE GASOLINA TAPON DE RADIADOR TAPON DE RADIADOR TENSOR ARBOL DE LEVAS TERMOSTATO	C/AA, C/DH {133 D x 25.4 mm} PRES. A LA CAJA DE DIR   A.A. A.A. ALT., C/AA, C/DH C/AA, C/DH  SIN LLAVE REGULAR (13 lbs) Sin palanca (13 lbs) Con palanca  170°F C/DH C/AA, C/DH {133 D x 25.4 mm} C/AA, C/DH	4 CIL, 2.5 L
V-6, 3.3 L	1998	K040470 K050336 T249 K040405 31115	A.A. ALT. BANDA ARBOL DE LEVAS D.H. TAPON DE ACEITE	C/AA, C/DH {133 D x 25.4 mm} C/AA, C/DH	4 CIL, 2.0 L
V-6, 3.0 L	1997	K040470 T249 92018 TCK249 22063 22147 22028 38044 K050336 K040405 31115 31748 31333 31533 T41059 33737	BANDA A.A. BANDA ARBOL DE LEVAS EDH KIT DE DISTRIBUCION MANGUERA DE PASO MANGUERA INF. MANGUERA SUP. POLEA SERPENTIN SERPENTIN TAPON DE ACEITE TAPON DE GASOLINA TAPON DE RADIADOR TAPON DE RADIADOR TENSOR ARBOL DE LEVAS TERMOSTATO	C/AA, C/DH {133 D x 25.4 mm} PRES. A LA CAJA DE DIR   A.A. ALT., C/AA, C/DH C/AA, C/DH  SIN LLAVE REGULAR (13 lbs) Sin palanca (13 lbs) Con palanca  170°F	4 CIL, 2.0 L

**ROGUE**











4 CIL, 2.5 L	2010	23480 23479 K060711 31115 31838 31836 33941	MANGUERA INF. MANGUERA SUP. SERPENTIN TAPON DE ACEITE TAPON DE GASOLINA TAPON DE GASOLINA TERMOSTATOS	CON LLAVE 180°
4 CIL, 2.5 L	2009	23480 23479 K060711 31115 31836 31838 33941	MANGUERA INF. MANGUERA SUP. SERPENTIN TAPON DE ACEITE TAPON DE GASOLINA TAPON DE GASOLINA TERMOSTATOS	CON LLAVE 180°
4 CIL, 2.5 L	2008	23480 23479 K060711 31115 31836 31838 33941	MANGUERA INF. MANGUERA SUP. SERPENTIN TAPON DE ACEITE TAPON DE GASOLINA TAPON DE GASOLINA TERMOSTATO	CON LLAVE 180 ° F

**SENTRA**

4 CIL, 2.0 L	2010	23286 23285 K060478 31115 31836 31838 31533 31333	MANGUERA INF. MANGUERA SUP. SERPENTIN TAPON DE ACEITE TAPON DE GASOLINA TAPON DE GASOLINA TAPONES DE RADIADOR TAPONES DE RADIADOR	CON LLAVE 13 LBS. 13 LBS.
4 CIL, 2.5 L	2010	22972 22971 K060711 31115 31838 31836 31333 31533 31333	MANGUERA INF. MANGUERA SUP. SERPENTIN TAPON DE ACEITE TAPON DE GASOLINA TAPON DE GASOLINA TAPONES DE RADIADOR TAPONES DE RADIADOR	13 LBS. 13 LBS.
4 CIL, 2.5 L	2009	22972 22971 K060711 31115 31838 31836 31533 31333 33941	MANGUERA INF. MANGUERA SUP. SERPENTIN TAPON DE ACEITE TAPON DE GASOLINA TAPON DE GASOLINA TAPONES DE RADIADOR TAPONES DE RADIADOR	CON LLAVE 13 LBS. 13 LBS. 180°
4 CIL, 2.0 L	2009	23286 23285 K060478 31115 31836 31838 31533 31333	MANGUERA INF. MANGUERA SUP. SERPENTIN TAPON DE ACEITE TAPON DE GASOLINA TAPON DE GASOLINA TAPONES DE RADIADOR TAPONES DE RADIADOR	CON LLAVE 13 LBS. 13 LBS. 180°
4 CIL, 2.0 L	2008	23286 23285 K060478 31115 31836 31838 31333 33941	MANGUERA INF. MANGUERA SUP. SERPENTIN TAPON DE ACEITE TAPON DE GASOLINA TAPON DE GASOLINA TAPONES DE RADIADOR TAPONES DE RADIADOR	CON LLAVE 13 LBS. 13 LBS. 180°
4 CIL, 2.5 L	2008	22972 22971 K060711 31115 31836 31838 31333	MANGUERA INF. MANGUERA SUP. SERPENTIN TAPON DE ACEITE TAPON DE GASOLINA TAPON DE GASOLINA TAPONES DE RADIADOR	CON LLAVE 13 LBS. 13 LBS.











    				    					
4 CIL, 2.5 L	2008	33941	TERMOSTATOS	180°			CH-180062	MANG. INF.	
4 CIL, 2.0 L	2007	23286	MANGUERA INF.				CH-180051	MANG. SUP.	
		23285	MANGUERA SUP.				K060435	SERPENTIN	ALT. & A.A.
		K060478	SERPENTIN				K040330	SERPENTIN	B.A. & D.H.
		31115	TAPON DE ACEITE				31115	TAPON DE ACEITE	
		31838	TAPON DE GASOLINA				31838	TAPON DE GASOLINA	SIN LLAVE REGULAR
		31836	TAPON DE GASOLINA	CON LLAVE			31836	TAPON DE GASOLINA	CON LLAVE REGULAR
		31333	TAPON DE RADIADOR				31533	TAPON DE RADIADOR	(13 lbs) Con palanca
4 CIL, 1.8 L	2006	22537	MANG. INF.				31333	TAPON DE RADIADOR	(13 lbs) Sin palanca
		22536	MANG. SUP.		4 CIL, 2.0 L	2002	BDH-5104	BOMBA DE DIR. HIDR.	
		36142	POLEA LOCA	ALT., C/AA			CH-180062	MANG. INF.	C/AA, C/DH, DOHC
		K060325	SERPENTIN	S/AA			22535	MANG. INF.	
		K040330	SERPENTIN	B.A. & D.H.			CH-180051	MANG. SUP.	C/AA, C/DH, DOHC
		K060435	SERPENTIN	C/AA			22534	MANG. SUP.	
		31115	TAPON DE ACEITE				K040335	SERPENTIN	B.A. & D.H.
		31333	TAPON DE RADIADOR	(13 lbs) Sin palanca			K060405	SERPENTIN	ALT. & A.A.
		31533	TAPON DE RADIADOR	(13 lbs) Con palanca			31115	TAPON DE ACEITE	
4 CIL, 2.5 L	2006	22972	MANG. INF.				31836	TAPON DE GASOLINA	CON LLAVE REGULAR
		22971	MANG. SUP.				31838	TAPON DE GASOLINA	SIN LLAVE REGULAR
		K060883	SERPENTIN				31533	TAPON DE RADIADOR	(13 lbs) Con palanca
		31115	TAPON DE ACEITE				31333	TAPON DE RADIADOR	(13 lbs) Sin palanca
		31838	TAPON DE GASOLINA	SIN LLAVE REGULAR	4 CIL, 1.8 L	2001	K060435	ALT & A.A.	
		38284	SENSOR MICRO-V				K040330	BA Y D.H.	
		33941	TERMOSTATO	180°F			19214	CALEF. A MOTOR	Lado del conductor
4 CIL, 1.8 L	2005	22537	MANG. INF.				CH-180062	MANGUERA INF.	S/AA, C/DH
		22536	MANG. SUP.				22537	MANGUERA INF.	
		K060325	SERPENTIN	S/AA			CH-180051	MANGUERA SUP.	S/AA, C/DH
		K040330	SERPENTIN	B.A. & D.H.			22536	MANGUERA SUP.	
		K060435	SERPENTIN				31115	TAPON DE ACEITE	
		31115	TAPON DE ACEITE				31838	TAPON DE GASOLINA	SIN LLAVE REGULAR
		31333	TAPON DE RADIADOR	(13 lbs) Sin palanca			31836	TAPON DE GASOLINA	CON LLAVE REGULAR
		31533	TAPON DE RADIADOR	(13 lbs) Con palanca			31533	TAPON DE RADIADOR	(13 lbs) Con palanca
4 CIL, 2.5 L	2005	22972	MANG. INF.				31333	TAPON DE RADIADOR	(13 lbs) Sin palanca
		22971	MANG. SUP.		4 CIL, 2.0 L	2001	K060405	ALT & A.A.	
		K060883	SERPENTIN				K060408	ALT.	C/AA, C/DH
		31115	TAPON DE ACEITE				K060436	ALT.	C/AA, C/DH
		31838	TAPON DE GASOLINA	SIN LLAVE REGULAR			BDH-5104	BOMBA DE DIR. HIDR.	
		38284	SENSOR MICRO-V				K040335	D.H.	C/AA, C/DH
		33941	TERMOSTATO	180°F			K040330	D.H.	C/AA, C/DH
4 CIL, 1.8 L	2004	22537	MANG. INF.				CH-180062	MANGUERA INF.	C/AA, C/DH
		22536	MANG. SUP.				22535	MANGUERA INF.	
		K060434	SERPENTIN				CH-180051	MANGUERA SUP.	C/AA, C/DH
		K060435	SERPENTIN	S/AA, S/DH			22534	MANGUERA SUP.	
		31115	TAPON DE ACEITE				31115	TAPON DE ACEITE	
		31333	TAPON DE RADIADOR	(13 lbs) Sin palanca			31836	TAPON DE GASOLINA	CON LLAVE REGULAR
		31533	TAPON DE RADIADOR	(13 lbs) Con palanca			31533	TAPON DE RADIADOR	(13 lbs) Con palanca
		K040330	TRANSMISION DE ACCESORIOS	D.H.			31333	TAPON DE RADIADOR	(13 lbs) Sin palanca
4 CIL, 2.5 L	2004	22972	MANG. INF.				33747	TERMOSTATO	170°F
		22971	MANG. SUP.				33747	TERMOSTATO	170°F
		K060434	SERPENTIN		4 CIL, 1.8 L	2000	K060435	ALT & A.A.	
		K060883	SERPENTIN				K040330	BA Y D.H.	
		31115	TAPON DE ACEITE				19214	CALEF. A MOTOR	Lado del conductor
		31838	TAPON DE GASOLINA	SIN LLAVE REGULAR			CH-180062	MANGUERA INF.	S/AA, C/DH
		31533	TAPON DE RADIADOR	(13 lbs) Con palanca			22537	MANGUERA INF.	
		31333	TAPON DE RADIADOR	(13 lbs) Sin palanca			CH-180051	MANGUERA SUP.	S/AA, C/DH
		38284	SENSOR MICRO-V				22536	MANGUERA SUP.	
		33941	TERMOSTATO	180°F			31115	TAPON DE ACEITE	
		K040330	TRANSMISION DE ACCESORIOS	D.H.			31615	TAPON DE GASOLINA	SIN LLAVE C/CONT. DE EMIS
4 CIL, 1.8 L	2003	K060330	D.H.				31778	TAPON DE GASOLINA	CON LLAVE REGULAR
		CH-180062	MANGUERA INF.				31734	TAPON DE GASOLINA	CON LLAVE C/CONT. DE EMIS
		22537	MANGUERA INF.				31748	TAPON DE GASOLINA	SIN LLAVE REGULAR
		CH-180051	MANGUERA SUP.				31533	TAPON DE RADIADOR	(13 lbs) Con palanca
		22536	MANGUERA SUP.				31333	TAPON DE RADIADOR	(13 lbs) Sin palanca
		K060435	SERPENTIN	S/AA, S/DH	4 CIL, 2.0 L	2000	K060405	ALT & A.A.	
		31115	TAPON DE ACEITE				K060436	ALT.	C/AA, C/DH
		31838	TAPON DE GASOLINA	SIN LLAVE REGULAR			K060408	ALT.	C/AA, C/DH
		31333	TAPON DE RADIADOR	(13 lbs) Sin palanca			BDH-5104	BOMBA DE DIR. HIDR.	
		31533	TAPON DE RADIADOR	(13 lbs) Con palanca			K040330	D.H.	C/AA, C/DH
4 CIL, 2.5 L	2003	K060883	SERPENTIN				K040335	D.H.	C/AA, C/DH
		31115	TAPON DE ACEITE				CH-180062	MANGUERA INF.	C/AA, C/DH
		31838	TAPON DE GASOLINA	SIN LLAVE REGULAR			22535	MANGUERA INF.	
		31333	TAPON DE RADIADOR	(13 lbs) Sin palanca			CH-180051	MANGUERA SUP.	C/AA, C/DH
		31533	TAPON DE RADIADOR	(13 lbs) Con palanca			22534	MANGUERA SUP.	
		38284	SENSOR MICRO-V				31115	TAPON DE ACEITE	
4 CIL, 1.8 L	2002	19214	MANG. CALEF. A MOTOR	LADO DEL CONDUCTOR			31734	TAPON DE GASOLINA	CON LLAVE C/CONT. DE EMIS



									
4 CIL, 2.0 L	2000	31748 31615 31778 31533 31333	TAPON DE GASOLINA TAPON DE GASOLINA TAPON DE GASOLINA TAPON DE RADIADOR TAPON DE RADIADOR	SIN LLAVE REGULAR SIN LLAVE C/CONT. DE EMIS CON LLAVE REGULAR (13 lbs) Con palanca (13 lbs) Sin palanca	CH-180011 K040320 K040285 31115 31778 31748 31615 31734 31333 31533		MANGUERA SUP. SERPENTIN SERPENTIN B.A. TAPON DE ACEITE TAPON DE GASOLINA TAPON DE GASOLINA TAPON DE GASOLINA TAPON DE RADIADOR TAPON DE RADIADOR	B.A. & D.H. C/AA, S/DH  CON LLAVE REGULAR SIN LLAVE REGULAR SIN LLAVE C/CONT. DE EMIS CON LLAVE C/CONT. DE EMIS (13 lbs) Sin palanca	
4 CIL, 1.6 L	1999	K060325 K060441 19187 19188 K040319 21793 CH-180062 CH-180082 CH-180071 CH-180051 21918 K040285 12T150 12T120 31748 31615 31734 31778 31533 31333	ALT. ALT. CALEF. A MULTIPLE CALEF. A TUBO-1 D.H. INF. - RADIADOR A TUBO MANGUERA INF. MANGUERA INF. MANGUERA SUP. MANGUERA SUP. MANGUERA SUP. SERPENTIN B.A. SUP. FLEXIBLE SUP. FLEXIBLE TAPON DE GASOLINA TAPON DE GASOLINA TAPON DE GASOLINA TAPON DE GASOLINA TAPON DE RADIADOR TAPON DE RADIADOR	S/AA, C/DH C/AA, C/DH C/AA, C/DH S/AA, C/DH C/AA, C/DH C/AA, C/DH S/AA, S/DH C/AA, C/DH C/AA, C/DH S/AA, S/DH C/AA, S/DH  SIN LLAVE REGULAR SIN LLAVE C/CONT. DE EMIS CON LLAVE C/CONT. DE EMIS (13 lbs) Con palanca (13 lbs) Sin palanca	4 CIL, 1.8 L	2010	23307 23306 K060473 31115 31836 31838 31533 31333	MANGUERA INF. MANGUERA SUP. SERPENTIN TAPON DE ACEITE TAPON DE GASOLINA TAPON DE GASOLINA TAPONES DE RADIADOR TAPONES DE RADIADOR	CON LLAVE   13 LBS. 13 LBS.
4 CIL, 2.0 L	1999	K060408 BDH-5104 19186 K040335 CH-180062 21837 22167 CH-180051 21763 31748 31615 31734 31778 31533 31333	ALT. BOMBA DE DIR. HIDR. CALEF. A TUBO-2 D.H. MANGUERA INF. MANGUERA INF. MANGUERA INF. MANGUERA SUP. MANGUERA SUP. TAPON DE GASOLINA TAPON DE GASOLINA TAPON DE GASOLINA TAPON DE GASOLINA TAPON DE RADIADOR TAPON DE RADIADOR	S/AA, C/DH C/AA, C/DH C/AA, C/DH C/AA, C/DH C/AA, C/DH C/AA, C/DH SIN LLAVE REGULAR SIN LLAVE C/CONT. DE EMIS CON LLAVE C/CONT. DE EMIS (13 lbs) Con palanca (13 lbs) Sin palanca	4 CIL, 1.8 L	2009	23307 23306 K060473 31115 31836 31838 31333 31533	MANGUERA INF. MANGUERA SUP. SERPENTIN TAPON DE ACEITE TAPON DE GASOLINA TAPON DE GASOLINA TAPONES DE RADIADOR TAPONES DE RADIADOR	CON LLAVE   13 LBS. 13 LBS.
4 CIL, 1.6 L	1998	K060325 K060441 K040319 CH-180082 CH-180062 CH-180071 CH-180051 K040285 31734 31778 31615 31734 31778 31533 31333 33747 33747	ALT. ALT. D.H. MANGUERA INF. MANGUERA INF. MANGUERA SUP. MANGUERA SUP. TAPON DE GASOLINA TAPON DE GASOLINA TAPON DE GASOLINA TAPON DE GASOLINA TAPON DE RADIADOR TAPON DE RADIADOR TERMOSTATO TERMOSTATO	S/AA, C/DH C/AA, C/DH C/AA, C/DH C/AA, C/DH S/AA, S/DH C/AA, C/DH C/AA, C/DH SIN LLAVE REGULAR SIN LLAVE C/CONT. DE EMIS CON LLAVE C/CONT. DE EMIS (13 lbs) Con palanca (13 lbs) Sin palanca 170°F 170°F	4 CIL, 1.8 L	2008	23307 23306 K060473 31115 31836 31838 31333 23307 23306 K060473 31115 31836 31838 31333	MANGUERA INF. MANGUERA SUP. SERPENTIN TAPON DE ACEITE TAPON DE GASOLINA TAPON DE GASOLINA TAPON DE RADIADOR MANGUERA INF. MANGUERA SUP. SERPENTIN TAPON DE ACEITE TAPON DE GASOLINA TAPON DE GASOLINA TAPON DE RADIADOR	CON LLAVE   13 LIBRAS  CON LLAVE 13 LIBRAS
4 CIL, 2.0 L	1998	K060408 BDH-5104 K040335 CH-180062 CH-180051 31115 31748 31615 31734 31778 31333 31533	ALT. BOMBA DE DIR. HIDR. D.H. MANGUERA INF. MANGUERA SUP. TAPON DE ACEITE TAPON DE GASOLINA TAPON DE GASOLINA TAPON DE GASOLINA TAPON DE GASOLINA TAPON DE RADIADOR TAPON DE RADIADOR	S/AA, C/DH C/AA, C/DH C/AA, C/DH C/AA, C/DH S/AA, S/DH C/AA, C/DH C/AA, C/DH SIN LLAVE REGULAR SIN LLAVE C/CONT. DE EMIS CON LLAVE C/CONT. DE EMIS (13 lbs) Sin palanca (13 lbs) Con palanca	4 CIL, 1.8 L	2007	23307 23306 K060473 31115 31836 31838 23307 23306 K060473 31115 31836 31838 31333	MANGUERA INF. MANGUERA INF. MANGUERA SUP. SERPENTIN TAPON DE ACEITE TAPON DE GASOLINA TAPON DE GASOLINA MANGUERA INF. MANGUERA SUP. SERPENTIN TAPON DE ACEITE TAPON DE GASOLINA TAPON DE GASOLINA TAPON DE RADIADOR	CON LLAVE   13 LIBRAS  CON LLAVE 13 LIBRAS
4 CIL, 2.0 L	1998	K060408 BDH-5104 K040335 CH-180062 CH-180051 31115 31748 31615 31734 31778 31333 31533	ALT. BOMBA DE DIR. HIDR. D.H. MANGUERA INF. MANGUERA SUP. TAPON DE ACEITE TAPON DE GASOLINA TAPON DE GASOLINA TAPON DE GASOLINA TAPON DE GASOLINA TAPON DE RADIADOR TAPON DE RADIADOR	S/AA, C/DH C/AA, C/DH C/AA, C/DH C/AA, C/DH S/AA, S/DH C/AA, C/DH C/AA, C/DH SIN LLAVE REGULAR SIN LLAVE C/CONT. DE EMIS CON LLAVE C/CONT. DE EMIS (13 lbs) Sin palanca (13 lbs) Con palanca	V-8, 5.6 L	2008	23281 21592 23280 36222 K070971 31115 31838 31838Y 31836 38340 33878 K070975 31115 31838 31836 31406 38340 33878 K070975 31115 31836 31406 38340 33878 K070975 31115 31838 31836 31406	MANGUERA INF. MANGUERA INF. MANGUERA SUP. POLEA SERPENTIN TAPON DE ACEITE TAPON DE GASOLINA TAPON DE GASOLINA TAPON DE GASOLINA TAPON DE RADIADOR TENSOR TERMOSTATOS SERPENTIN TAPON DE ACEITE TAPON DE GASOLINA TAPON DE GASOLINA TAPON DE RADIADOR TENSOR MICRO-V TERMOSTATO SERPENTIN TAPON DE ACEITE TAPON DE GASOLINA TAPON DE GASOLINA TAPON DE RADIADOR TENSOR MICRO-V TERMOSTATO SERPENTIN TAPON DE ACEITE TAPON DE GASOLINA TAPON DE GASOLINA TAPON DE RADIADOR	180°   FLEX FUEL CON LLAVE   180°  180° F  180° F  16 LIBRAS 16 LIBRAS 180° F  16 LIBRAS 16 LIBRAS 180° F  16 LIBRAS 16 LIBRAS CON LLAVE 16 LIBRAS
4 CIL, 1.6 L	1997	K040330 K040317 K060441 K060325 BDH-5157 K040319 360520(718) 19188 CH-180032	A.A. ALT. ALT. ALT. BOMBA DE DIR. HIDR. D.H. EDH MANG. CALEF. A TUBO-1 MANGUERA INF.	C/AA, C/DH S/AA, C/DH C/AA, C/DH S/AA, C/DH C/AA, C/DH C/AA, C/DH PRESION	V-8, 5.6 L	2006	K070975 31115 31838 31836 31406	MANGUERA INF. MANGUERA INF. MANGUERA SUP. TAPON DE GASOLINA TAPON DE GASOLINA TAPON DE GASOLINA TAPON DE RADIADOR TAPON DE RADIADOR	CON LLAVE   16 LIBRAS 16 LIBRAS CON LLAVE 16 LIBRAS





    				    						
4 CIL, 2.4 L	2002	31838	TAPON DE GASOLINA	SIN LLAVE REGULAR	V-6, 3.3 L	2000	19213	CALEF. A TUBO		
		31836	TAPON DE GASOLINA	CON LLAVE REGULAR			19213	CALEF. A TUBO		
		31533	TAPON DE RADIADOR	(13 lbs) Con palanca			PQ17490	D.H.		C/AA,C/DH
		31333	TAPON DE RADIADOR	(13 lbs) Sin palanca			8497 GS	D.H.		C/AA,C/DH
		33747	TERMOSTATO	170°F			8494 GS	D.H.		
		6362 GS	VENT & ALT				22416	INF. - RADIADOR A TUBO		
		K040529	A.A.	S/Supercargador			22185	MANGUERA SUP.		
		K060733	A.A.	C/Supercargador			19607	PASO		
		K050316	ALT.				38037	POLEA		D.H.
		T249	BANDA ARBOL DE LEVAS	{133 D x 25.4 mm}			36116	POLEA		A.A.
		19203	CALEF. A "T"-1				31115	TAPON DE ACEITE		
		19203	CALEF. A "T"-2				31734	TAPON DE GASOLINA		CON LLAVE C/CONT. DE EMI:
		TCK249	KIT DE DISTRIBUCION				31748	TAPON DE GASOLINA		SIN LLAVE REGULAR
		18460	MANG. VALV. DE AIRE A MULTII				31615	TAPON DE GASOLINA		SIN LLAVE C/CONT. DE EMIS
		22518	MANGUERA DE PASO				31778	TAPON DE GASOLINA		CON LLAVE REGULAR
22478	MANGUERA INF.		31533	TAPON DE RADIADOR	(13 lbs) Con palanca					
22516	MANGUERA INF.		31333	TAPON DE RADIADOR	(13 lbs) Sin palanca					
22517	MANGUERA SUP.		33747	TERMOSTATO	170°F					
35B 1/2"	T-1 A TUBO-2		33747	TERMOSTATO	170°F					
18462	T-2 A TUBO-3		6362 GS	VENT & ALT						
31115	TAPON DE ACEITE		K040529	A.A.						
31836	TAPON DE GASOLINA	CON LLAVE REGULAR	K040530	A.A.	C/DH					
31838	TAPON DE GASOLINA	SIN LLAVE REGULAR	K050316	ALT.						
31333	TAPON DE RADIADOR	(13 lbs) Sin palanca	K050317	ALT.	C/AA, C/DH					
31533	TAPON DE RADIADOR	(13 lbs) Con palanca	T249	BANDA ARBOL DE LEVAS	{133 D x 25.4 mm}					
T41059	SENSOR ARBOL DE LEVAS		K050486	D.H.	C/AA, C/DH					
33738	TERMOSTATO	180°F	22516	INF. - TUBO A TERMOSTATO						
18461	TUBO-2 A TUBO-4		TCK249	KIT DE DISTRIBUCION						
35B 1/2"	TUBO-5 A VALV. REG. DE AIRE		22478	MANGUERA SUP.	C/AA, C/DH					
K050486	VENTILADOR, D. H.		22517	MANGUERA SUP.						
4 CIL, 2.4 L	2001	7306 GS	A.A.		V-6, 3.3 L	2000	22518	PASO		
		3660 GS	BANDA	VENT & ALT.			38005	POLEA		VENTILADOR Y D.H.
		8365 GS	BANDA A.A.				31115	TAPON DE ACEITE		
		8494 GS	BANDA D.H.				31734	TAPON DE GASOLINA		CON LLAVE C/CONT. DE EMI:
		19212	CALEF. A MOTOR				31748	TAPON DE GASOLINA		SIN LLAVE REGULAR
		19213	CALEF. A TUBO				31615	TAPON DE GASOLINA		SIN LLAVE C/CONT. DE EMIS
		8497 GS	D.H.				31778	TAPON DE GASOLINA		CON LLAVE REGULAR
		22416	INF. - RADIADOR A TUBO				31333	TAPON DE RADIADOR		(13 lbs) Sin palanca
		22413	MANG. INF.				31533	TAPON DE RADIADOR		(13 lbs) Con palanca
		CHARTER 1	MANG. INF.	RAD A TUBO			T41059	SENSOR ARBOL DE LEVAS		
		22185	MANGUERA SUP.	TUBO A MOTOR			33737	TERMOSTATO		170°F
		19607	PASO				33737	TERMOSTATO		170°F
		36116	POLEA	A.A.						
		38037	POLEA LOCA							
		K060408	SERPENTIN							
31115	TAPON DE ACEITE									
31838	TAPON DE GASOLINA	SIN LLAVE REGULAR								
31836	TAPON DE GASOLINA	CON LLAVE REGULAR								
31533	TAPON DE RADIADOR	(13 lbs) Con palanca								
31333	TAPON DE RADIADOR	(13 lbs) Sin palanca								
33747	TERMOSTATO	170°F								
33747	TERMOSTATO	170°F								
6362 GS	VENT & ALT									
K040529	A.A.									
K050316	ALT.									
T249	BANDA ARBOL DE LEVAS	{133 D x 25.4 mm}								
22478	INF. - RADIADOR A TUBO									
22516	INF. - TUBO A TERMOSTATO									
TCK249	KIT DE DISTRIBUCION									
22517	MANGUERA SUP.									
22518	PASO									
38005	POLEA	VENTILADOR Y D.H.								
31115	TAPON DE ACEITE									
31838	TAPON DE GASOLINA	SIN LLAVE REGULAR								
31836	TAPON DE GASOLINA	CON LLAVE REGULAR								
31533	TAPON DE RADIADOR	(13 lbs) Con palanca								
31333	TAPON DE RADIADOR	(13 lbs) Sin palanca								
T41059	SENSOR ARBOL DE LEVAS									
33737	TERMOSTATO	170°F								
33737	TERMOSTATO	170°F								
K050486	VENT & D.H.									
7306 GS	A.A.									
9365	A.A.	C/AA,C/DH								
6352 GS	ALT.	C/AA,C/DH								
19212	CALEF. A MOTOR									

**X-TRAIL**

4 CIL, 2.5 L	2008	K060711	SERPENTIN		
		31115	TAPON DE ACEITE		
		31836	TAPON DE GASOLINA		CON LLAVE
		31838	TAPON DE GASOLINA		180 ° F
4 CIL, 2.4 L	2007	K060883	SERPENTIN		
		4 CIL, 2.4 L	2006		K060883
4 CIL, 2.4 L	2005	K060883	SERPENTIN		
		4 CIL, 2.4 L	2004		K060883
4 CIL, 2.4 L	2003	K060888	SERPENTIN	ALTERNADOR	

**OLDSMOBILE**

**EIGHTY EIGHT**

V-6, 3.8 L	1999	19724	CALEF. A MOTOR		
		19723	CALEF. A MOTOR		
		22139	MANGUERA INF.		
		22375	MANGUERA SUP.		
		38006	POLEA		
		38007	POLEA LOCA LISA		C/Supercargador
		38009	POLEA LOCA RANURADA		C/Supercargador
		K060938	SERPENTIN		TRANSMISION DE ACCESOR
		K060721	SERPENTIN		SUPERCARGADOR
		31103	TAPON DE ACEITE		
		31636	TAPON DE GASOLINA		SIN LLAVE REGULAR
		31523	TAPON DE RADIADOR		(16 lbs) Sin Palanca
38289	SENSOR MICRO-V				
33429	TERMOSTATO	195°F			

V-6, 3.8 L	1998	91781 19723 19724 22139 22375 38015 K060938 31103 31636 31523 38152 33429	EDH MANG. CALEF. A MOTOR INF. MANG. CALEF. A MOTOR SUP. MANG. INF. MANG. SUP. POLEA SERPENTIN TAPON DE ACEITE TAPON DE GASOLINA TAPON DE RADIADOR SENSOR MICRO-V TERMOSTATO	PREISION          SIN LLAVE REGULAR (16 lbs) Sin Palanca  195°F

4 CIL, 1.6 L		T1581 CH-230002 CH-230001 K060615	BANDA ARBOL DE LEVAS MANGUERA INF. MANGUERA SUP. SERPENTIN	{134 D x 25.4 mm}
4 CIL, 1.4 L	2002	T901 T901A TCK901A CH-230002 CH-230001 K060615 T43023	BANDA ARBOL DE LEVAS BANDA ARBOL DE LEVAS KIT DE DISTRIBUCION MANGUERA INF. MANGUERA SUP. SERPENTIN TENSOR ARBOL DE LEVAS	CON A/A
4 CIL, 1.6 L	2002	T1581 CH-230002 CH-230001 K060615	BANDA ARBOL DE LEVAS MANGUERA INF. MANGUERA SUP. SERPENTIN	{134 D x 25.4 mm}
4 CIL, 1.4 L	2001	T901 TCK901 CH-230002 CH-230001 K060570 K060615 T43023	BANDA ARBOL DE LEVAS KIT DE DISTRIBUCION MANGUERA INF. MANGUERA SUP. SERPENTIN SERPENTIN TENSOR ARBOL DE LEVAS	SIN A/A CON A/A
4 CIL, 1.6 L	2001	T1581 CH-230002 CH-230001 K060615	BANDA ARBOL DE LEVAS MANGUERA INF. MANGUERA SUP. SERPENTIN	{134 D x 25.4 mm}
4 CIL, 1.4 L	2000	T901 TCK901 CH-230002 CH-230001 K060570 K060615 T43023	BANDA ARBOL DE LEVAS KIT DE DISTRIBUCION MANGUERA INF. MANGUERA SUP. SERPENTIN SERPENTIN TENSOR ARBOL DE LEVAS	SIN A/A CON A/A
4 CIL, 1.6 L	2000	T1581 CH-230002 CH-230001 K060615 K060570	BANDA ARBOL DE LEVAS MANGUERA INF. MANGUERA SUP. SERPENTIN SERPENTIN	{134 D x 25.4 mm}
4 CIL, 1.4 L	1999	T901 TCK901 CH-230002 CH-230001 K060570 K060615 T43023	BANDA ARBOL DE LEVAS KIT DE DISTRIBUCION MANGUERA INF. MANGUERA SUP. SERPENTIN SERPENTIN TENSOR ARBOL DE LEVAS	SIN A/A CON A/A
4 CIL, 1.6 L	1999	T1581 CH-230002 CH-230001 K060615 K060570	BANDA ARBOL DE LEVAS MANGUERA INF. MANGUERA SUP. SERPENTIN SERPENTIN	{134 D x 25.4 mm}
4 CIL, 1.4 L	1998	T901 TCK901 CH-230002 CH-230001 K060570 K060615 T43023	BANDA ARBOL DE LEVAS KIT DE DISTRIBUCION MANGUERA INF. MANGUERA SUP. SERPENTIN SERPENTIN TENSOR ARBOL DE LEVAS	SIN A/A CON A/A

## PEUGEOT

### 206

4 CIL, 1.4 L	2008	T901A TCK901A CH-230002 CH-230001 K060615 T43023	BANDA ARBOL DE LEVAS KIT DE DISTRIBUCION MANGUERA INF. MANGUERA SUP. SERPENTIN TENSOR ARBOL DE LEVAS	CON A/A
4 CIL, 1.6 L	2008	T1581 CH-230002 CH-230001 K060615	BANDA ARBOL DE LEVAS MANGUERA INF. MANGUERA SUP. SERPENTIN	{134 D x 25.4 mm}
4 CIL, 1.4 L	2007	T901A TCK901A CH-230002 CH-230001 K060615 T43023	BANDA ARBOL DE LEVAS KIT DE DISTRIBUCION MANGUERA INF. MANGUERA SUP. SERPENTIN TENSOR ARBOL DE LEVAS	CON A/A
4 CIL, 1.6 L	2007	T1581 CH-230002 CH-230001 K060615	BANDA ARBOL DE LEVAS MANGUERA INF. MANGUERA SUP. SERPENTIN	{134 D x 25.4 mm}
4 CIL, 1.4 L	2006	T901A TCK901A CH-230002 CH-230001 K060615 T43023	BANDA ARBOL DE LEVAS KIT DE DISTRIBUCION MANGUERA INF. MANGUERA SUP. SERPENTIN TENSOR ARBOL DE LEVAS	{104 D x 17 mm}
4 CIL, 1.6 L	2006	T1581 CH-230002 CH-230001 K060615	BANDA ARBOL DE LEVAS MANGUERA INF. MANGUERA SUP. SERPENTIN	{134 D x 25.4 mm}
4 CIL, 1.4 L	2005	T901A TCK901A CH-230002 CH-230001 K060615 T43023	BANDA ARBOL DE LEVAS KIT DE DISTRIBUCION MANGUERA INF. MANGUERA SUP. SERPENTIN TENSOR ARBOL DE LEVAS	CON A/A
4 CIL, 1.6 L	2005	T1581 CH-230002 CH-230001 K060615	BANDA ARBOL DE LEVAS MANGUERA INF. MANGUERA SUP. SERPENTIN	{134 D x 25.4 mm}
4 CIL, 1.4 L	2004	T901A TCK901A CH-230002 CH-230001 K060615 T43023	BANDA ARBOL DE LEVAS KIT DE DISTRIBUCION MANGUERA INF. MANGUERA SUP. SERPENTIN TENSOR ARBOL DE LEVAS	CON A/A
4 CIL, 1.6 L	2004	T1581 CH-230002 CH-230001 K060615	BANDA ARBOL DE LEVAS MANGUERA INF. MANGUERA SUP. SERPENTIN	{134 D x 25.4 mm}
4 CIL, 1.4 L	2003	T901A TCK901A CH-230002 CH-230001 K060615 T43023	BANDA ARBOL DE LEVAS KIT DE DISTRIBUCION MANGUERA INF. MANGUERA SUP. SERPENTIN TENSOR ARBOL DE LEVAS	CON A/A

### 207

4 CIL, 1.6 L	2009	T1581 T42191 K060415 K060288 T43159 T38313	BANDA ARBOL DE LEVAS POLEA DE DISTRIBUCION SERPENTIN SERPENTIN TENSOR TENSOR	134 D X25.4 MM
4 CIL, 1.6 L TURBO	2009	K060355	SERPENTIN	
4 CIL, 1.6 L	2008	T1581 T42191 K060288	BANDA ARBOL DE LEVAS POLEA DE DISTRIBUCION SERPENTIN	134 D X25.4 MM SIN A.A.





4 CIL, 1.6 L	2008	K060415 T38313 T43159	SERPENTIN TENSOR TENSOR	CON A.A.
4 CIL, 1.6 L TURBO	2008	K060355	SERPENTIN	



**406**

4 CIL, 2.0 L	2004	T1504 K060630	BANDA ARBOL DE LEVAS SERPENTIN	
V-6, 3.0 L	2004	T1596 K060630	BANDA ARBOL DE LEVAS SERPENTIN	
4 CIL, 2.0 L	2003	T1504 K060630	BANDA ARBOL DE LEVAS SERPENTIN	
V-6, 3.0 L	2003	T1596 K060630	BANDA ARBOL DE LEVAS SERPENTIN	
4 CIL, 2.0 L	2002	T1504 K060630	BANDA ARBOL DE LEVAS SERPENTIN	
V-6, 3.0 L	2002	T1596 K060630	BANDA ARBOL DE LEVAS SERPENTIN	
4 CIL, 2.0 L	2001	T1504 K060630	BANDA ARBOL DE LEVAS SERPENTIN	
V-6, 3.0 L	2001	T1596 6PK1600	BANDA ARBOL DE LEVAS SERPENTIN	
4 CIL, 2.0 L	2000	T1504 K060630	BANDA ARBOL DE LEVAS SERPENTIN	
V-6, 3.0 L	2000	T1596 6PK1600	BANDA ARBOL DE LEVAS SERPENTIN	
V-6, 3.0 L	1999	T1596 6PK1600	BANDA ARBOL DE LEVAS SERPENTIN	

**306**

4 CIL, 1.8 L	2004	T1504 K060425 K060653	BANDA ARBOL DE LEVAS SERPENTIN SERPENTIN	SIN A.A. CON A.A.
4 CIL, 2.0 L	2004	T1504 K060630 K060458	BANDA ARBOL DE LEVAS SERPENTIN SERPENTIN	CON A.A. SIN A.A.
4 CIL, 1.8 L	2003	T1504 K060425 K060653	BANDA ARBOL DE LEVAS SERPENTIN SERPENTIN	{136 D x 25.4 mm} SIN A.A. CON A.A.
4 CIL, 2.0 L	2003	T1504 K060630 K060458	BANDA ARBOL DE LEVAS SERPENTIN SERPENTIN	CON A.A. SIN A.A.
4 CIL, 1.8 L	2002	T1504 K060653 K060425	BANDA ARBOL DE LEVAS SERPENTIN SERPENTIN	CON A.A. SIN A.A.
4 CIL, 2.0 L	2002	T1504 K060458 K060630	BANDA ARBOL DE LEVAS SERPENTIN SERPENTIN	SIN A.A. CON A.A.
4 CIL, 1.8 L	2001	T1504 K060653 K060425	BANDA ARBOL DE LEVAS SERPENTIN SERPENTIN	C/AA S/AA
4 CIL, 2.0 L	2001	T1504 K060458 K060630	BANDA ARBOL DE LEVAS SERPENTIN SERPENTIN	SIN A.A. CON A.A.
4 CIL, 1.8 L	2000	T1504 K060653 K060425	BANDA ARBOL DE LEVAS SERPENTIN SERPENTIN	C/AA S/AA
4 CIL, 2.0 L	2000	T1504 K060458 K060630	BANDA ARBOL DE LEVAS SERPENTIN SERPENTIN	SIN A.A. CON A.A.
4 CIL, 1.8 L	1999	T1504 K060653 K060425	BANDA ARBOL DE LEVAS SERPENTIN SERPENTIN	C/AA S/AA
4 CIL, 2.0 L	1999	T1504 K060458 K060630	BANDA ARBOL DE LEVAS SERPENTIN SERPENTIN	SIN A.A. CON A.A.

**407**

4 CIL, 2.2 L	2008	T1503 K060400	BANDA ARBOL DE LEVAS SERPENTIN	
V-6, 3.0 L	2008	T1596 K060630	BANDA ARBOL DE LEVAS SERPENTIN	
4 CIL, 2.2 L	2007	T1503 K060400	BANDA ARBOL DE LEVAS SERPENTIN	
V-6, 3.0 L	2007	T1596 K060630	BANDA ARBOL DE LEVAS SERPENTIN	{259 D x 32 mm}
4 CIL, 2.2 L	2006	T1503 K060400	BANDA ARBOL DE LEVAS SERPENTIN	
V-6, 3.0 L	2006	T1596 K060630	BANDA ARBOL DE LEVAS SERPENTIN	
4 CIL, 2.2 L	2005	T1503 K060400	BANDA ARBOL DE LEVAS SERPENTIN	
V-6, 3.0 L	2005	T1596 K060630	BANDA ARBOL DE LEVAS SERPENTIN	

**307**

4 CIL, 2.0 L	2009	T1503 T38320 T41235 K060672 T36109 T43022	BANDA ARBOL DE LEVAS POLEA POLEA DE DISTRIBUCION SERPENTIN TENSOR TENSOR DISTRIBUCION	153 D X 25.4 MM
4 CIL, 2.0 L	2008	T1503 T38320 T41235 K060672 T36109 T43022	BANDA ARBOL DE LEVAS POLEA POLEA DE DISTRIBUCION SERPENTIN TENSOR TENSOR DISTRIBUCION	
4 CIL, 2.0 L	2007	T1503 T38320 T41235 K060672 T36109 T43022	BANDA ARBOL DE LEVAS POLEA POLEA DE DISTRIBUCION SERPENTIN TENSOR TENSOR DISTRIBUCION	
4 CIL, 2.0 L	2006	T1503 T38320 T41235 K060672 T36109 T43022	BANDA ARBOL DE LEVAS POLEA POLEA DE DISTRIBUCION SERPENTIN TENSOR TENSOR DISTRIBUCION	
4 CIL, 2.0 L	2005	T1503 T38320 T41235 K060672 T36109 T43022	BANDA ARBOL DE LEVAS POLEA POLEA DE DISTRIBUCION SERPENTIN TENSOR TENSOR DISTRIBUCION	

**GRAND RAID**

4 CIL, 1.6 L	2008	T1581 CH-230002 CH-230001 T42066 K060615 T43157	BANDA ARBOL DE LEVAS MANGUERA INF. MANGUERA SUP. POLEA DE DISTRIBUCION SERPENTIN TENSOR DISTRIBUCION	{134 D x 25.4 mm} CON A.A.
4 CIL, 1.6 L	2007	T1581 CH-230002 CH-230001 T42066 K060615 T43157	BANDA ARBOL DE LEVAS MANGUERA INF. MANGUERA SUP. POLEA DE DISTRIBUCION SERPENTIN TENSOR DISTRIBUCION	{134 D x 25.4 mm} CON A.A.
4 CIL, 1.6 L	2006	T1581 CH-230002 CH-230001 T42066 K060615 T43157	BANDA ARBOL DE LEVAS MANGUERA INF. MANGUERA SUP. POLEA DE DISTRIBUCION SERPENTIN TENSOR DISTRIBUCION	{134 D x 25.4 mm} CON A.A.
4 CIL, 1.6 L	2005	T1581 CH-230002 CH-230001 T42066 K060615 T43157	BANDA ARBOL DE LEVAS MANGUERA INF. MANGUERA SUP. POLEA DE DISTRIBUCION SERPENTIN TENSOR DISTRIBUCION	{134 D x 25.4 mm} SIN A.A.
4 CIL, 1.6 L	2004	T1581 CH-230002 CH-230001 T42066 K060615	BANDA ARBOL DE LEVAS MANGUERA INF. MANGUERA SUP. POLEA DE DISTRIBUCION SERPENTIN	{134 D x 25.4 mm} CON A.A.



4 CIL, 1.6 L 2004 T43157 TENSOR DISTRIBUCION

**PARTNER**

4 CIL, 1.6 L	2008	T1581	BANDA ARBOL DE LEVAS	{134 D x 25.4 mm}
		CH-230002	MANGUERA INF.	
		CH-230001	MANGUERA SUP.	
		T42066	POLEA DE DISTRIBUCION	
		K060615	SERPENTIN	CON A.A.
4 CIL, 1.6 L	2007	T1581	BANDA ARBOL DE LEVAS	{134 D x 25.4 mm}
		CH-230002	MANGUERA INF.	
		CH-230001	MANGUERA SUP.	
		T42066	POLEA DE DISTRIBUCION	
		K060615	SERPENTIN	CON A.A.
4 CIL, 1.6 L	2006	T1581	BANDA ARBOL DE LEVAS	{134 D x 25.4 mm}
		CH-230002	MANGUERA INF.	
		CH-230001	MANGUERA SUP.	
		T42066	POLEA DE DISTRIBUCION	
		K060615	SERPENTIN	CON A.A.
4 CIL, 1.6 L	2005	T1581	BANDA ARBOL DE LEVAS	{134 D x 25.4 mm}
		CH-230002	MANGUERA INF.	
		CH-230001	MANGUERA SUP.	
		T42066	POLEA DE DISTRIBUCION	
		K060615	SERPENTIN	SIN A.A.
4 CIL, 1.6 L	2004	T1581	BANDA ARBOL DE LEVAS	{134 D x 25.4 mm}
		CH-230002	MANGUERA INF.	
		CH-230001	MANGUERA SUP.	
		T42066	POLEA DE DISTRIBUCION	
		K060615	SERPENTIN	CON A.A.

V-6, 3.4 L	2002	22557	MANGUERA INF.	
		22361	MANGUERA SUP.	
		38043	POLEA	
		38009	POLEA DEL TENSOR	
		38006	POLEA LOCA	
		35B 3/8"	RECUPERADOR	
		K060864	SERPENTIN	
		31103	TAPON DE ACEITE	
		31636	TAPON DE GASOLINA	SIN LLAVE REGULAR
		31523	TAPON DE RADIADOR	(16 lbs) Sin Palanca
		38104	TENSOR MICRO-V	
		33329	TERMOSTATO	195°F
		18020	TUBO-1 A VALV. REG. DE AIRE	
		35B 3/8"	VALV. REG. DE AIRE A TUBO 1	
		92034	EDH	PRESION, C/AWD
V-6, 3.4 L	2001	19026	MANGUERA DE PASO	
		22557	MANGUERA INF.	
		22361	MANGUERA SUP.	
		38009	POLEA DEL TENSOR	
		38006	POLEA LOCA	
		35B 3/8"	RECUPERADOR	
		K060864	SERPENTIN	
		31103	TAPON DE ACEITE	
		31636	TAPON DE GASOLINA	SIN LLAVE REGULAR
		31523	TAPON DE RADIADOR	(16 lbs) Sin Palanca
		38104	TENSOR MICRO-V	
		33329	TERMOSTATO	195°F
		18020	TUBO-1 A VALV. REG. DE AIRE	
		35B 3/8"	VALV. REG. DE AIRE A TUBO 1	
		92034	EDH	PRESION C/AWD
V-6, 3.4 L	2005	22557	MANGUERA INF.	
		22361	MANGUERA SUP.	
		38009	POLEA DEL TENSOR	
		38006	POLEA LOCA	
		K060864	SERPENTIN	
		K060863	SERPENTIN	C/AA
		31103	TAPON DE ACEITE	
		31636	TAPON DE GASOLINA	SIN LLAVE REGULAR
		31523	TAPON DE RADIADOR	(16 lbs) Sin Palanca
		38104	TENSOR MICRO-V	
		33329	TERMOSTATO	195°F











**PONTIAC**

**AZTEK**

V-6, 3.4 L	2005	92034	EDH	PRESION		
		19026	MANGUERA DE PASO	MANGUERA DE PASO		
		22557	MANGUERA INF.			
		22361	MANGUERA SUP.			
		38043	POLEA			
		38006	POLEA	LOCA		
		38009	POLEA			
		K060864	SERPENTIN			
		31103	TAPON DE ACEITE			
		31636	TAPON DE GASOLINA	SIN LLAVE REGULAR		
		31523	TAPON DE RADIADOR	(16 lbs) Sin Palanca		
		38104	TENSOR MICRO-V			
		33329	TERMOSTATO	195°F		
		V-6, 3.4 L	2004	19288	CALEF. A TUBO 1	
				19287	CALEFACTOR A TUBO 2	
28500	CONECTOR - CALEF. A TUBO 1					
28500	CONECTOR - CALEF. A TUBO 2					
19026	MANGUER DE PASO					
22557	MANGUERA INF.					
22361	MANGUERA SUP.					
38043	POLEA					
38009	POLEA DEL TENSOR					
38006	POLEA LOCA					
35B 3/8"	RADIADOR A TANQ. DE RECUP.					
K060864	SERPENTIN					
31103	TAPON DE ACEITE					
31636	TAPON DE GASOLINA			SIN LLAVE REGULAR		
31523	TAPON DE RADIADOR			(16 lbs) Sin Palanca		
V-6, 3.4 L	2003	38104	TENSOR MICRO-V			
		33329	TERMOSTATO	195°F		
		18020	TUBO 1 A VALV. REG. DE AIRE			
		35B 3/8"	VALV. REG. DE AIRE A TUBO 1			
		18250	VALVULA A TUBO - 3			
		19026	MANGUERA DE PASO			

**BONNEVILLE**

V-6, 3.8 L	2005	92055	EDH	PRESION		
		22329	MANG. INF.			
		22328	MANG. SUP.			
		38006	POLEA TENSORA			
		K060926	SERPENTIN			
		31103	TAPON DE ACEITE			
		31636	TAPON DE GASOLINA	SIN LLAVE REGULAR		
		31523	TAPON DE RADIADOR	(16 lbs) Sin Palanca		
		38271	TENSOR MICRO-V			
		33429	TERMOSTATO	195°F		
		92055	EDH	PRESION		
		V-6, 3.8 L	2004	22329	MANG. INF.	
				22328	MANG. SUP.	
				38006	POLEA TENSORA	
				K060926	SERPENTIN	
31103	TAPON DE ACEITE					
31636	TAPON DE GASOLINA			SIN LLAVE REGULAR		
31523	TAPON DE RADIADOR			(16 lbs) Sin Palanca		
38271	TENSOR MICRO-V					
33429	TERMOSTATO			195°F		
92055	EDH			PRESION		
V-6, 3.8 L	2003			22329	MANG. INF.	
				22328	MANG. SUP.	
				38009	POLEA LOCA	RANURADA, SUPER CARGA
				38007	POLEA LOCA	LISA, SUPER CARGADOR
				38006	POLEA TENSORA	
		K060926	SERPENTIN			
		K060725	SERPENTIN	C/SUPER CARGADOR		
		31103	TAPON DE ACEITE			
		31636	TAPON DE GASOLINA	SIN LLAVE REGULAR		

    				    					
V-6, 3.8 L	2003	31523 38271 33429	TAPON DE RADIADOR TENSOR MICRO-V TERMOSTATO	(16 lbs) Sin Palanca 195°F		31103 31636 31523	TAPON DE ACEITE TAPON DE GASOLINA TAPON DE RADIADOR	SIN LLAVE REGULAR (16 lbs) Sin Palanca	
V-6, 3.8 L	2002	92055 22329 22328 38007 38009 K060926 K060725	EDH MANGUERA INF. MANGUERA SUP. POLEA LOCA LISA POLEA LOCA RANURADA SERPENTIN SERPENTIN	PRESION		38152 33429	TENSOR MICRO-V TERMOSTATO	195°F	
<b>FIREBIRD TRANS AM</b>									
V-6, 3.8 L	2001	31103 31636 31523 33429 92055 22329 22328 38007 38009 K060926 K060725	TAPON DE ACEITE TAPON DE GASOLINA TAPON DE RADIADOR TERMOSTATO EDH MANGUERA INF. MANGUERA SUP. POLEA LOCA POLEA LOCA RANURADA SERPENTIN SERPENTIN	SIN LLAVE REGULAR (16 lbs) Sin Palanca 195°F PRESION	V-8, 5.7 L	2002	K040410 19673 80229 22354 22352 18125 38008 38006 K060790 21528 22353 31103 31636 31525 33910 18908	A.A. CALEF. A TUBO-1 EDH MANGUERA INF. MANGUERA SUP. PASO - RADIADOR A BA POLEA DEL TENSOR POLEA LOCA SERPENTIN SUP. - D.H. Cooler A MOTOR SUP. - RADIADOR A D.H. Cooler TAPON DE ACEITE TAPON DE GASOLINA TAPON DE RADIADOR TERMOSTATO TUBO-1 A MOTOR	PRESION S/Enfriador de DH S/Enfriador de Aceite de motor
V-6, 3.8 L	2000	31103 31636 31523 33429 92055 22139 22329 22375 22328 38007 38009 K060923 K060926 31103 31636 31523 33429 K060725	TAPON DE ACEITE TAPON DE GASOLINA TAPON DE RADIADOR TERMOSTATO EDH MANGUERA INF. MANGUERA SUP. MANGUERA SUP. POLEA LOCA POLEA LOCA RANURADA SERPENTIN SERPENTIN SERPENTIN SERPENTIN TAPON DE ACEITE TAPON DE GASOLINA TAPON DE RADIADOR TERMOSTATO TURBO	SIN LLAVE REGULAR (16 lbs) Sin Palanca 195°F PRESION	V-8, 5.7 L	2001	K040410 19673 80229 22354 22352 18125 38008 38006 K060790 21528 22353 31103 31636 31525 33910 18908	A.A. CALEF. A TUBO-1 EDH MANGUERA INF. MANGUERA SUP. PASO - RADIADOR A BA POLEA DEL TENSOR POLEA LOCA SERPENTIN SUP. - D.H. Cooler A MOTOR SUP. - RADIADOR A D.H. Cooler TAPON DE ACEITE TAPON DE GASOLINA TAPON DE RADIADOR TERMOSTATO TUBO-1 A MOTOR	SIN LLAVE REGULAR (18 lbs) Sin Palanca 180°F
V-6, 3.8 L	1999	19724 92055 22139 22375 38006 38007 38009 K060938 31103 31636 31523 33429 K060721	CALEF. A MOTOR EDH MANGUERA INF. MANGUERA SUP. POLEA DEL TENSOR POLEA LOCA POLEA LOCA RANURADA SERPENTIN SERPENTIN TAPON DE ACEITE TAPON DE GASOLINA TAPON DE RADIADOR TERMOSTATO TURBO	Superior PRESION	V-8, 5.7 L	2000	K040410 19673 80229 22354 22352 18125 38008 38006 K060790 21528 22353 31103 31636 31525 33910	A.A. CALEF. A TUBO-1 EDH MANGUERA INF. MANGUERA SUP. PASO - RADIADOR A BA POLEA DEL TENSOR POLEA LOCA SERPENTIN SUP. - D.H. Cooler A MOTOR SUP. - RADIADOR A D.H. Cooler TAPON DE ACEITE TAPON DE GASOLINA TAPON DE RADIADOR TERMOSTATO	SIN LLAVE REGULAR (18 lbs) Sin Palanca 180°F
V-6, 3.8 L	1998	92055 22139 22375 38009 38006 38015 38007 K060938 31103 31636 31523 38152 33429 K060721	EDH MANGUERA INF. MANGUERA SUP. POLEA POLEA POLEA DEL TENSOR POLEA LOCA SERPENTIN SERPENTIN TAPON DE ACEITE TAPON DE GASOLINA TAPON DE RADIADOR TENSOR MICRO-V TERMOSTATO TURBO	PRESION	V-8, 5.7 L	1999	K040410 19673 80229 22354 22352 18125 38008 38006 K060790 21528 22353 31103 31636 31525 33910	A.A. CALEF. A TUBO-1 EDH MANGUERA INF. MANGUERA SUP. PASO - RADIADOR A BA POLEA DEL TENSOR POLEA LOCA SERPENTIN SUP. - D.H. Cooler A MOTOR SUP. - RADIADOR A D.H. Cooler TAPON DE ACEITE TAPON DE GASOLINA TAPON DE RADIADOR TERMOSTATO	SIN LLAVE REGULAR (18 lbs) Sin Palanca 180°F
V-6, 3.8 L	1997	91781 22139 22375 38009 38006 38015 38007 K060938 K060721	EDH MANGUERA INF. MANGUERA SUP. POLEA POLEA POLEA DEL TENSOR POLEA LOCA SERPENTIN SERPENTIN	SUPER CARGADO (CON CAN) SUPER CARGADO	V-8, 5.7 L	1998	80229 38008 38006 K060790 21528 22353 31103 31636 31525 33910	EDH POLEA DEL TENSOR POLEA LOCA SERPENTIN SUP. - D.H. Cooler A MOTOR SUP. - RADIADOR A D.H. Cooler TAPON DE ACEITE TAPON DE GASOLINA TAPON DE RADIADOR TERMOSTATO	SIN LLAVE REGULAR (18 lbs) Sin Palanca 180°F
					V-8, 5.7 L		80229 38008 38006 K060790 K040410	EDH POLEA DEL TENSOR POLEA LOCA SERPENTIN SERPENTIN	PRESION A.A.

V-8, 5.7 L	1998	31103 31850 31525 33910	TAPON DE ACEITE TAPON DE GASOLINA TAPON DE RADIADOR TERMOSTATO	(18 lbs) Sin Palanca 180°F
V-8, 5.7 L	1997	71797 22263 21439 38001 K060642 31111 31633 31525 38145 33788	EDH MANG. INF. MANG. SUP. POLEA DEL TENSOR SERPENTIN TAPON DE ACEITE TAPON DE GASOLINA TAPON DE RADIADOR TENSOR MICRO-V TERMOSTATO	PRESION     SIN LLAVE REGULAR (18 lbs) Sin Palanca  180°F

		31843 31844 31532 38177 33943	TAPON DE GASOLINA TAPON DE GASOLINA TAPON DE RADIADOR TENSOR MICRO-V TERMOSTATO	CON LLAVE 15 LIBRAS  180 ° F

<b>G3</b>				
4 CIL, 1.6 L	2008	T335 21667 22918 21531 20942 38024 38015 K060739	BANDA ARBOL DE LEVAS MANGUERA INF. MANGUERA INF. MANGUERA SUP. MANGUERA SUP. POLEA POLEA SERPENTIN	{127 D x 25 mm} TUBO A BOMBA DE AGUA RADIADOR A TUBO CON A.A. SIN A.A. SIN A.A.
4 CIL, 1.6 L	2007	T335 21667 22918 20942 21531 38015 38024 K060739	BANDA ARBOL DE LEVAS MANGUERA INF. MANGUERA INF. MANGUERA SUP. MANGUERA SUP. POLEA POLEA SERPENTIN	{127 D x 25 mm} TUBO A BOMBA DE AGUA RADIADOR A TUBO SIN A.A. CON A.A. SIN A.A.
4 CIL, 1.6 L	2006	T335 21667 22918 20942 21531 38024 38015 K060739	BANDA ARBOL DE LEVAS MANGUERA INF. MANGUERA INF. MANGUERA SUP. MANGUERA SUP. POLEA POLEA SERPENTIN	{127 D x 25 mm} TUBO A BOMBA DE AGUA RADIADOR A TUBO SIN A.A. CON A.A. SIN A.A.

<b>G5</b>				
4 CIL, 2.2 L	2008	38011 K050400 K050345 31103 31844 31843 31532 38177 33943	POLEA SERPENTIN SERPENTIN TAPON DE ACEITE TAPON DE GASOLINA TAPON DE GASOLINA TAPON DE RADIADOR TENSOR MICRO-V TERMOSTATO	CON A.A. SIN A.A.  CON LLAVE 15 LIBRAS  180 ° F
4 CIL, 2.2 L	2007	38011 K050400 K050345 31103 31843 31844 31532 38177 33943	POLEA SERPENTIN SERPENTIN TAPON DE ACEITE TAPON DE GASOLINA TAPON DE GASOLINA TAPON DE RADIADOR TENSOR MICRO-V TERMOSTATO	CON A.A. SIN A.A.  CON LLAVE 15 LIBRAS  180 ° F
4 CIL, 2.4 L	2007	38011 K050400 K050345 31103 31843 31844 31532 38177 33943	POLEA SERPENTIN SERPENTIN TAPON DE ACEITE TAPON DE GASOLINA TAPON DE GASOLINA TAPON DE RADIADOR TENSOR MICRO-V TERMOSTATO	CON A.A. SIN A.A.  CON LLAVE 15 LIBRAS  180 ° F











<b>G4</b>				
4 CIL, 2.2 L	2006	23165 23166 38011 K050345 K050400 31103 31844 31843 31532 38177 33943	MANGUERA INF. MANGUERA SUP. POLEA SERPENTIN SERPENTIN TAPON DE ACEITE TAPON DE GASOLINA TAPON DE GASOLINA TAPON DE RADIADOR TENSOR MICRO-V TERMOSTATO	SIN A.A. CON A.A.  CON LLAVE 15 LIBRAS  180 ° F
4 CIL, 2.4 L	2006	23165 23166 38011 K050400 K050345 31103	MANGUERA INF. MANGUERA SUP. POLEA SERPENTIN SERPENTIN TAPON DE ACEITE	CON A.A. SIN A.A.  CON A.A. SIN A.A.

<b>G6</b>				
V-6, 3.5 L	2008	19768 23122 38009 38006 K061093 31103 31844 31843 38420	MANGUERA DE PASO MANGUERA SUP. POLEA POLEA SERPENTIN TAPON DE ACEITE TAPON DE GASOLINA TAPON DE GASOLINA TENSOR MICRO-V	REQUIERE 2  CON LLAVE 15 LIBRAS
V-6, 3.6 L	2008	K060935 31843 31844 31532 38397	SERPENTIN TAPON DE GASOLINA TAPON DE GASOLINA TAPON DE RADIADOR TENSOR MICRO-V	CON LLAVE 15 LIBRAS
V-6, 3.5 L	2007	19768 23124 23122 38006 38009 K061093 31103 31844 31843 38420	MANGUERA DE PASO MANGUERA INF. MANGUERA SUP. POLEA POLEA SERPENTIN TAPON DE ACEITE TAPON DE GASOLINA TAPON DE GASOLINA TENSOR MICRO-V	REQUIERE 2  CON LLAVE 15 LIBRAS
V-6, 3.6 L	2007	K060935 31843 31844 31532 38397	SERPENTIN TAPON DE GASOLINA TAPON DE GASOLINA TAPON DE RADIADOR TENSOR MICRO-V	CON LLAVE 15 LIBRAS





V-6, 3.4 L	2001	31532 38104 33828 33329	TAPON DE RADIADOR TENSOR MICRO-V TERMOSTATO TERMOSTATO	(15 lbs) Sin palanca 180°F 195°F		22094 21557 K060685	MANGUERA INF. MANGUERA SUP. SERPENTIN		
4 CIL, 2.4 L	2000	19739 80232 22397 22331 K050478 31103 31111 31636 31782 31532 33828	CALEF. A VALVULA EDH MANGUERA INF. MANGUERA SUP. SERPENTIN TAPON DE ACEITE TAPON DE ACEITE TAPON DE GASOLINA TAPON DE GASOLINA TAPON DE RADIADOR TERMOSTATO	PRES. A LA CAJA DE DIR  SIN LLAVE REGULAR CON LLAVE REGULAR (15 lbs) Sin palanca 180°F	V-6, 3.1 L	1997	360990(717) EDH 19026 22094 21557 38007 K060685 31103	TAPON DE GASOLINA TAPON DE GASOLINA TAPON DE RADIADOR TERMOSTATO MANGUERA DE PASO MANGUERA INF. MANGUERA SUP. POLEA SERPENTIN TAPON DE ACEITE	SIN LLAVE REGULAR CON LLAVE REGULAR (15 lbs) Sin palanca 195°F PRESION
V-6, 3.4 L	2000	19049 19048 365370(919) 22524 22332 19026 38009 38006 K060868 31103 31636 31782 31532 38104 33329	CALEF. A TUBO-1 CALEF. A TUBO-2 EDH MANGUERA INF. MANGUERA SUP. PASO POLEA DEL TENSOR POLEA LOCA SERPENTIN TAPON DE ACEITE TAPON DE GASOLINA TAPON DE GASOLINA TAPON DE RADIADOR TENSOR MICRO-V TERMOSTATO	PRESION S/ASISTENCIA			31636 31782 31405 38105 33329	TAPON DE GASOLINA TAPON DE GASOLINA TAPON DE RADIADOR TENSOR MICRO-V TERMOSTATO	SIN LLAVE REGULAR CON LLAVE REGULAR (15 lbs) Sin palanca 195°F
<b>GRAND PRIX</b>									
4 CIL, 2.4 L	1999	19739 80232 22397 22331 38011 K050474 K050478 31103 31111 31636 31782 31532 38146 33828	CALEF. A VALVULA EDH MANGUERA INF. MANGUERA SUP. POLEA DEL TENSOR SERPENTIN SERPENTIN TAPON DE ACEITE TAPON DE ACEITE TAPON DE GASOLINA TAPON DE GASOLINA TAPON DE RADIADOR TENSOR MICRO-V TERMOSTATO	SFI RAM AIR  SIN LLAVE REGULAR CON LLAVE REGULAR (15 lbs) Sin palanca 195°F PRES. A LA CAJA DE DIR	V-6, 3.8 L	2005	22373 22814 38009 38001 38006 K060905 K060670 31103 31843 31532 38271 33429	MANG. INF. MANG. SUP. POLEA LOCA POLEA LOCA POLEA TENSORA SERPENTIN SERPENTIN TAPON DE ACEITE TAPON DE GASOLINA TAPON DE RADIADOR TENSOR MICRO-V TERMOSTATO	RANURADA, SUPER CARGA LISA, SUPER CARGADOR ACCESORIOS ACCESORIOS SUPER CARGADOR  SIN LLAVE REGULAR (15 lbs) Sin palanca ACCESORIOS 195°F
V-6, 3.4 L	1999	19049 19048 92039 22334 22524 22332 19026 38009 38006 K060868 31103 31636 31782 31532 38104 33329	CALEF. A TUBO-1 CALEF. A TUBO-2 EDH MANGUERA INF. MANGUERA INF. MANGUERA SUP. PASO POLEA DEL TENSOR POLEA LOCA SERPENTIN TAPON DE ACEITE TAPON DE GASOLINA TAPON DE GASOLINA TAPON DE RADIADOR TENSOR MICRO-V TERMOSTATO	PRESION C/ASIST. VARIABLE 1er diseño 2do diseño	V-6, 3.8 L	2004	22373 22814 38001 38009 38006 K060905 K060670 31103 31636 31782 31523 38271 33429 91940 22373 22344 38009 38001 38006 K060670 K060905 31103 31636 31782 31523 31516 38271 33429	MANG. INF. MANG. SUP. POLEA LOCA POLEA LOCA POLEA TENSORA SERPENTIN SERPENTIN TAPON DE ACEITE TAPON DE GASOLINA TAPON DE GASOLINA TAPON DE RADIADOR TENSOR MICRO-V TERMOSTATO EDH MANG. INF. MANG. SUP. POLEA LOCA POLEA LOCA POLEA TENSORA SERPENTIN SERPENTIN TAPON DE ACEITE TAPON DE GASOLINA TAPON DE GASOLINA TAPON DE RADIADOR TENSOR MICRO-V TERMOSTATO	LISA, SUPER CARGADOR RANURADA, SUPER CARGA ACCESORIOS ACCESORIOS SUPER CARGADOR  SIN LLAVE REGULAR CON LLAVE REGULAR (16 lbs) Sin Palanca ACCESORIOS 195°F PRESION C/ASIST. VARIABLE
4 CIL, 2.4 L	1998	80041 360990(717) 22065 21347 K050474 K050478 31103 31111 31636 31782 31405 33828	EDH EDH MANG. INF. MANG. SUP. SERPENTIN SERPENTIN TAPON DE ACEITE TAPON DE ACEITE TAPON DE GASOLINA TAPON DE GASOLINA TAPON DE RADIADOR TERMOSTATO	PRES. A LA CAJA DE DIR PRESION C/TRANS AUTOMATICA Y MA	V-6, 3.1 L	2002	19211 92054 22345 22344 19026 38001 K060703 31103 31636 31782 31516 31523	CALEF. A TUBO-2 EDH MANGUERA INF. MANGUERA SUP. PASO POLEA DEL TENSOR SERPENTIN SERPENTIN TAPON DE ACEITE TAPON DE GASOLINA TAPON DE GASOLINA TAPON DE RADIADOR	PRESION  PRESION
V-6, 3.1 L	1998	80303 360990(717) 19026	EDH EDH MANGUERA DE PASO	PRES. DESDE LA BOMBA, C/ PRESION					SIN LLAVE REGULAR CON LLAVE REGULAR (16 lbs) Sin palanca (16 lbs) Sin Palanca

									
V-6, 3.1 L	2002	38105	TENSOR MICRO-V	195°F			31523	TAPON DE RADIADOR	(16 lbs) Sin Palanca
		33329	TERMOSTATO				33429	TERMOSTATO	195°F
V-6, 3.8 L	2002	19120	CALEF. A MOTOR	Superior	V-6, 3.1 L	1999	18446	CALEF. A TUBO-1	
		19121	CALEF. A MOTOR	Inferior			19054	CALEF. A TUBO-2	
		92041	EDH	PRESION S/ASISTENCIA			92054	EDH	PRESION
		22373	MANGUERA INF.				22345	MANGUERA INF.	
		22344	MANGUERA SUP.				22344	MANGUERA SUP.	
		38007	POLEA LOCA LISA	C/Supercargador			19026	PASO	
		38009	POLEA LOCA RANURADA	C/Supercargador			38001	POLEA DEL TENSOR	
		K060915	SERPENTIN	TRANSMISION DE ACCESOR			K060938	SERPENTIN	MODELO MEX, 6PK2385
		K060663	SERPENTIN	SUPERCARGADOR			K060703	SERPENTIN	
		31103	TAPON DE ACEITE				31103	TAPON DE ACEITE	
		31636	TAPON DE GASOLINA	SIN LLAVE REGULAR			31636	TAPON DE GASOLINA	SIN LLAVE REGULAR
		31782	TAPON DE GASOLINA	CON LLAVE REGULAR			31782	TAPON DE GASOLINA	CON LLAVE REGULAR
		31523	TAPON DE RADIADOR	(16 lbs) Sin Palanca			31516	TAPON DE RADIADOR	(16 lbs) Con palanca
		31516	TAPON DE RADIADOR	(16 lbs) Con palanca			31523	TAPON DE RADIADOR	(16 lbs) Sin Palanca
		33429	TERMOSTATO	195°F			38105	TENSOR MICRO-V	
V-6, 3.1 L	2001	19211	CALEF. A TUBO-2		V-6, 3.8 L	1999	33329	TERMOSTATO	195°F
		92054	EDH	PRESION			19120	CALEF. A MOTOR	Superior
		22345	MANGUERA INF.				19121	CALEF. A MOTOR	Inferior
		22344	MANGUERA SUP.				92041	EDH	PRESION S/ASISTENCIA
		19026	PASO				22373	MANGUERA INF.	
		38001	POLEA DEL TENSOR				22344	MANGUERA SUP.	
		K060703	SERPENTIN				38006	POLEA DEL TENSOR	
		31103	TAPON DE ACEITE				38007	POLEA LOCA LISA	C/Supercargador
		31636	TAPON DE GASOLINA	SIN LLAVE REGULAR			38009	POLEA LOCA RANURADA	C/Supercargador
		31782	TAPON DE GASOLINA	CON LLAVE REGULAR			K060915	SERPENTIN	TRANSMISION DE ACCESOR
		31523	TAPON DE RADIADOR	(16 lbs) Sin Palanca			K060938	SERPENTIN	MODELO MEXICO 6PK2385
		31516	TAPON DE RADIADOR	(16 lbs) Con palanca			K060663	SERPENTIN	SUPERCARGADOR
		38105	TENSOR MICRO-V				31103	TAPON DE ACEITE	
		33329	TERMOSTATO	195°F			31636	TAPON DE GASOLINA	SIN LLAVE REGULAR
V-6, 3.8 L	2001	19120	CALEF. A MOTOR	Superior			31782	TAPON DE GASOLINA	CON LLAVE REGULAR
		19121	CALEF. A MOTOR	Inferior			31523	TAPON DE RADIADOR	(16 lbs) Sin Palanca
		92041	EDH	PRESION S/ASISTENCIA			31516	TAPON DE RADIADOR	(16 lbs) Con palanca
		22373	MANGUERA INF.		V-6, 3.1 L	1998	33429	TERMOSTATO	195°F
		22344	MANGUERA SUP.				91935	EDH	PRESION
		38006	POLEA DEL TENSOR				22345	MANGUERA INF.	
		38007	POLEA LOCA LISA	C/Supercargador			22344	MANGUERA SUP.	
		38009	POLEA LOCA RANURADA	C/Supercargador			38001	POLEA DEL TENSOR	
		K060915	SERPENTIN				K060695	SERPENTIN	
		K060663	SERPENTIN	SUPERCARGADOR			31103	TAPON DE ACEITE	
		31103	TAPON DE ACEITE				31636	TAPON DE GASOLINA	SIN LLAVE REGULAR
		31636	TAPON DE GASOLINA	SIN LLAVE REGULAR			31782	TAPON DE GASOLINA	CON LLAVE REGULAR
		31782	TAPON DE GASOLINA	CON LLAVE REGULAR			31523	TAPON DE RADIADOR	(16 lbs) Sin Palanca
		31516	TAPON DE RADIADOR	(16 lbs) Con palanca			38105	TENSOR MICRO-V	
		31523	TAPON DE RADIADOR	(16 lbs) Sin Palanca			33329	TERMOSTATO	195°F
		33429	TERMOSTATO	195°F	V-6, 3.8 L	1998	92041	EDH	PRESION S/ASISTENCIA
V-6, 3.1 L	2000	19211	CALEF. A TUBO-2				91940	EDH	PRESION
		92054	EDH	PRESION			22373	MANGUERA INF.	
		22345	MANGUERA INF.				22344	MANGUERA SUP.	
		22344	MANGUERA SUP.				38006	POLEA DEL TENSOR	
		19026	PASO				38015	POLEA DEL TENSOR	
		38001	POLEA DEL TENSOR				38009	POLEA LOCA	
		K060703	SERPENTIN				38007	POLEA LOCA	
		31103	TAPON DE ACEITE				K060935	SERPENTIN	SEGUNDO DISEÑO
		31636	TAPON DE GASOLINA	SIN LLAVE REGULAR			K060930	SERPENTIN	SFI PRIMER DISEÑO
		31782	TAPON DE GASOLINA	CON LLAVE REGULAR			31103	TAPON DE ACEITE	
		31516	TAPON DE RADIADOR	(16 lbs) Con palanca			31636	TAPON DE GASOLINA	SIN LLAVE REGULAR
		31523	TAPON DE RADIADOR	(16 lbs) Sin Palanca			31782	TAPON DE GASOLINA	CON LLAVE REGULAR
		38105	TENSOR MICRO-V				31523	TAPON DE RADIADOR	(16 lbs) Sin Palanca
		33329	TERMOSTATO	195°F			38152	TENSOR MICRO-V	
V-6, 3.8 L	2000	19121	CALEF. A MOTOR	Inferior			33429	TERMOSTATO	195°F
		19120	CALEF. A MOTOR	Superior	V-6, 3.1 L	1997	K060663	TURBO	SFI PRIMER DISEÑO
		92041	EDH	PRESION S/ASISTENCIA			91935	EDH	PRESION
		22373	MANGUERA INF.				22345	MANGUERA INF.	
		22344	MANGUERA SUP.				22344	MANGUERA SUP.	
		38006	POLEA DEL TENSOR				38007	POLEA	
		38007	POLEA LOCA LISA	C/Supercargador			K060695	SERPENTIN	
		38009	POLEA LOCA RANURADA	C/Supercargador			31103	TAPON DE ACEITE	
		K060915	SERPENTIN				31636	TAPON DE GASOLINA	SIN LLAVE REGULAR
		K060663	SERPENTIN	SUPERCARGADOR			31734	TAPON DE GASOLINA	CON LLAVE C/CONT. DE EMI:
		31103	TAPON DE ACEITE				31523	TAPON DE RADIADOR	(16 lbs) Sin Palanca
		31636	TAPON DE GASOLINA	SIN LLAVE REGULAR			38105	TENSOR MICRO-V	
		31782	TAPON DE GASOLINA	CON LLAVE REGULAR			33329	TERMOSTATO	195°F
		31516	TAPON DE RADIADOR	(16 lbs) Con palanca	V-6, 3.8 L	1997	92041	EDH	PRESION S/ASISTENCIA



V-6, 3.8 L	1997	91940 22373 22344 38006 38015 38009 38007 K060930 K060935 31103 31636 31734 31523 38152 33429 K060663	EDH MANGUERA INF. MANGUERA SUP. POLEA DEL TENSOR POLEA DEL TENSOR POLEA LOCA POLEA LOCA SERPENTIN SERPENTIN TAPON DE ACEITE TAPON DE GASOLINA TAPON DE GASOLINA TAPON DE RADIADOR SENSOR MICRO-V TERMOSTATO TURBO	PRESION        SFI PRIMER DISEÑO SFI SEGUNDO DISEÑO  SIN LLAVE REGULAR CON LLAVE C/CONT. DE EMÍ: (16 lbs) Sin Palanca  195°F SFI PRIMER DISEÑO
------------	------	--	--	--



## MONTANA

V-6, 3.9 L	2008	19768 22090 23140 38009 38006 K061098 38420	MANGUERA DE PASO MANGUERA INF. MANGUERA SUP. POLEA POLEA SERPENTIN TENSOR MICRO-V	REQUIERE 2
V-6, 3.9 L	2007	19768 22090 23140 38006 38009 K061098 38420	MANGUERA DE PASO MANGUERA INF. MANGUERA SUP. POLEA POLEA SERPENTIN TENSOR MICRO-V	REQUIERE 2
V-6, 3.5 L	2006	19026 23079 23078 38043 38009 K060888 31103 31844 31843 31516 38104 33329	MANGUERA DE PASO MANGUERA INF. MANGUERA SUP. POLEA POLEA SERPENTIN TAPON DE ACEITE TAPON DE GASOLINA TAPON DE GASOLINA TAPON DE RADIADOR SENSOR MICRO-V TERMOSTATO	CON LLAVE 16 LIBRAS 195°
V-6, 3.9 L	2006	19768 22090 23140 38009 38006 K061098 38420	MANGUERA DE PASO MANGUERA INF. MANGUERA SUP. POLEA POLEA SERPENTIN TENSOR MICRO-V	REQUIERE 2

## MATIZ G2











4 CIL, 1.0 L	2009	T1570 CH-149102 CH-149101 K040285 K040262 K040378 K040310 T41267	BANDA ARBOL DE LEVAS MANGUERA INF. MANGUERA SUP. SERPENTIN SERPENTIN SERPENTIN SERPENTIN TENSOR	109 D X 25.4 mm   D.H. ALT. A.A. Y D.H. A.A.
4 CIL, 1.0 L	2008	K040310 K040262 T1570 K040285 CH-149102 CH-149101 K040378 T41267	A.A. ALT. BANDA ARBOL DE LEVAS D.H. MANGUERA INF. MANGUERA SUP. SERPENTIN TENSOR	{109 D x 25.4 mm}  A/A Y D/H
4 CIL, 1.0 L	2007	K040310 K040262 T1570 K040285 CH-149102 CH-149101 K040378 T41267	A.A. ALT. BANDA ARBOL DE LEVAS D.H. MANGUERA INF. MANGUERA SUP. SERPENTIN TENSOR	{109 D x 25.4 mm}
4 CIL, 1.0 L	2006	K040310 K040262 T1570 K040285 CH-149102 CH-149101 K040378 T41267	A.A. ALT. BANDA ARBOL DE LEVAS D.H. MANGUERA INF. MANGUERA SUP. SERPENTIN TENSOR	{109 D x 25.4 mm}
4 CIL, 1.0 L	2005	K040310 K040262 T1570 K040285 CH-149102 CH-149101 K040378 T41267	A.A. ALT. BANDA ARBOL DE LEVAS D.H. MANGUERA INF. MANGUERA SUP. SERPENTIN TENSOR	{109 D x 25.4 mm}
4 CIL, 1.0 L	2004	K040310 K040262 T1570 K040285 CH-149102 CH-149101 K040378 T41267	A.A. ALT. BANDA ARBOL DE LEVAS D.H. MANGUERA INF. MANGUERA SUP. SERPENTIN TENSOR	{109 D x 25.4 mm}
4 CIL, 1.0 L	2003	K040310 K040262 T1570 K040285 CH-149102 CH-149101 K040378 T41267	A.A. ALT. BANDA ARBOL DE LEVAS D.H. MANGUERA INF. MANGUERA SUP. SERPENTIN TENSOR	{109 D x 25.4 mm}





## SOLSTICE

4 CIL, 2.4 L	2008	K050402 K030310 38011 31103 31843 31844 31532 38177 33943	ALT. Y A/A D.H. POLEA TAPON DE ACEITE TAPON DE GASOLINA TAPON DE GASOLINA TAPON DE RADIADOR TENSOR MICRO-V TERMOSTATO	ALT. Y A/A   CON LLAVE 15 LIBRAS ALT. Y A/A 180 ° F
4 CIL, 2.4 L	2007	K050402 K030310 38011 31103 31843 31844 31532 38177 33943	ALT. Y A/A D.H. POLEA TAPON DE ACEITE TAPON DE GASOLINA TAPON DE GASOLINA TAPON DE RADIADOR TENSOR MICRO-V TERMOSTATO	ALT. Y A/A  ALT. Y A/A  CON LLAVE 15 LIBRAS ALT. Y A/A 180 ° F
4 CIL, 2.4 L	2006	K050402 K030310 38011 31103 31844 31843 31532 38177 33943	ALT. Y A/A D.H. POLEA TAPON DE ACEITE TAPON DE GASOLINA TAPON DE GASOLINA TAPON DE RADIADOR TENSOR MICRO-V TERMOSTATO	ALT. Y A/A  ALT. Y A/A  CON LLAVE 15 LIBRAS ALT. Y A/A 180 ° F

## SUNFIRE

4 CIL, 2.2 L	2005	71798 80301 35B 3/8" 35B 3/8" 22708 22345 38011	EDH EDH MANGUERA DE CALEFACCIÓN MANGUERA DE CALEFACCIÓN MANGUERA INF. MANGUERA SUP. POLEA	RETORNO PRES. A LA CAJA DE DIR
--------------	------	---	---	-----------------------------------

    				    						
4 CIL, 2.2 L	2005	K050400 31103 31636 31532 38177 33943	SERPENTIN TAPON DE ACEITE TAPON DE GASOLINA TAPON DE RADIADOR TENSOR MICRO-V TERMOSTATO	SIN LLAVE REGULAR (15 lbs) Sin palanca  180°F				38032 K050478 31111 31111 31636 31782 31782 31532 38247 33828	POLEA SERPENTIN TAPON DE ACEITE TAPON DE GASOLINA TAPON DE GASOLINA TAPON DE GASOLINA TAPON DE RADIADOR TENSOR MICRO-V TERMOSTATO	SIN LLAVE REGULAR CON LLAVE REGULAR CON LLAVE REGULAR (15 lbs) Sin palanca  180°F
4 CIL, 2.2 L	2004	19815 80301 22708 22345 19816 38011 35B 3/8" K050400 35B 3/8"	CALEF. A MOTOR EDH MANGUERA INF. MANGUERA SUP. MOTOR A CALEF. POLEA DEL TENSOR RADIADOR A TANQ.DE REC. SERPENTIN TANQUE DE RECUPERACIÓN A	PRES. A LA CAJA DE DIR		4 CIL, 2.2 L	2001	19811 91804 80051 22342 38015 38011 K050630 K050887 31121 31636 31636 31782 31532 38164 33828 20618	CALEF. A TUBO-1 EDH EDH MANGUERA SUP. POLEA DEL TENSOR POLEA LOCA SERPENTIN SERPENTIN TAPON DE ACEITE TAPON DE GASOLINA TAPON DE GASOLINA TAPON DE GASOLINA TAPON DE RADIADOR TENSOR MICRO-V TERMOSTATO TERMOSTATO A TUBO-3	RETORNO PRESION  S/AA C/AA  SIN LLAVE REGULAR SIN LLAVE REGULAR CON LLAVE REGULAR (15 lbs) Sin palanca  180°F
4 CIL, 2.3 L	2004	31636 31782	TAPON DE GASOLINA TAPON DE GASOLINA	SIN LLAVE REGULAR CON LLAVE REGULAR		4 CIL, 2.3 L	2001	31636 31782	TAPON DE GASOLINA TAPON DE GASOLINA	SIN LLAVE REGULAR CON LLAVE REGULAR
4 CIL, 2.4 L	2004	31636 31782	TAPON DE GASOLINA TAPON DE GASOLINA	SIN LLAVE REGULAR CON LLAVE REGULAR		4 CIL, 2.4 L	2001	80051 22148 22152 18242 38032	EDH MANGUERA INF. MANGUERA SUP. PASO - TUO A TANQUE POLEA	PRESION
4 CIL, 2.2 L	2003	80301 80301 22708 22345 38011 K050400 K050345 31103 31636 31782 31523 38177 33943	EDH EDH MANG. INF. MANG. SUP. POLEA SERPENTIN SERPENTIN TAPON DE ACEITE TAPON DE GASOLINA TAPON DE GASOLINA TAPON DE RADIADOR TENSOR MICRO-V TERMOSTATO	PRESION PRES. A LA CAJA DE DIR  C/AA S/AA  SIN LLAVE REGULAR CON LLAVE REGULAR (16 lbs) Sin Palanca  180°F		4 CIL, 2.2 L	2000	19811 80051 91804 22343 22342 38015 38011 K050887 K050630 31121 31636 31782 31532 38164 33828 20618	CALEF. A TUBO-1 EDH EDH MANGUERA INF. MANGUERA SUP. POLEA DEL TENSOR POLEA LOCA SERPENTIN SERPENTIN TAPON DE ACEITE TAPON DE GASOLINA TAPON DE GASOLINA TAPON DE RADIADOR TENSOR MICRO-V TERMOSTATO TERMOSTATO A TUBO-3	PRESION RETORNO S/AA S/AA  SIN LLAVE REGULAR CON LLAVE REGULAR (15 lbs) Sin palanca  180°F
4 CIL, 2.3 L	2003	31636 31782	TAPON DE GASOLINA TAPON DE GASOLINA	SIN LLAVE REGULAR CON LLAVE REGULAR		4 CIL, 2.2 L	2000	19811 80051 91804 22343 22342 38015 38011 K050887 K050630 31121 31636 31782 31532 38164 33828 20618	CALEF. A TUBO-1 EDH EDH MANGUERA INF. MANGUERA SUP. POLEA DEL TENSOR POLEA LOCA SERPENTIN SERPENTIN TAPON DE ACEITE TAPON DE GASOLINA TAPON DE GASOLINA TAPON DE RADIADOR TENSOR MICRO-V TERMOSTATO TERMOSTATO A TUBO-3	PRESION RETORNO S/AA S/AA  SIN LLAVE REGULAR CON LLAVE REGULAR (15 lbs) Sin palanca  180°F
4 CIL, 2.4 L	2003	31636 31782	TAPON DE GASOLINA TAPON DE GASOLINA	SIN LLAVE REGULAR CON LLAVE REGULAR		4 CIL, 2.4 L	2000	31636 31782	TAPON DE GASOLINA TAPON DE GASOLINA	SIN LLAVE REGULAR CON LLAVE REGULAR
4 CIL, 2.2 L	2002	19811 80051 22343 19611 22342 22345 38015 38011 28408 K050887 K050630 K050400 35B 3/8" 31103 31636 31782 31532 38164 38177 33828 20618 19736 28408 19810	CALEF. A TUBO-1 EDH MANGUERA INF. MANGUERA INF. MANGUERA SUP. MANGUERA SUP. POLEA POLEA DEL TENSOR RECUPERADOR SERPENTIN SERPENTIN SERPENTIN TANQUE DE RECUPERACION A TAPON DE ACEITE TAPON DE GASOLINA TAPON DE GASOLINA TAPON DE RADIADOR TENSOR MICRO-V TENSOR MICRO-V TERMOSTATO TERMOSTATO A TUBO-3 TUBO-1 A "T" TUBO-2 A TANQ. DE RECUP. TUBO-3 A CALEF.	Motor Numero de serie 4 PRESION Motor Numero de serie 4 Motor Numero de serie F; TUBI Motor Numero de serie F Motor Numero de serie 4 C/AA; Motor serie 4 S/AA; Motor número de serie 4 C/AA; Motor número de serie F4 CIL, 2.3 L Motor Numero de serie F		4 CIL, 2.4 L	2000	362810(8001 80051 22148 CH-140511 22152 18242 38032 K050478 31111 31636 31782 31532 38247 33828 19704 19741	EDH EDH MANGUERA INF. MANGUERA SUP. MANGUERA SUP. PASO - TUO A TANQUE POLEA SERPENTIN TAPON DE ACEITE TAPON DE GASOLINA TAPON DE GASOLINA TAPON DE RADIADOR TENSOR MICRO-V TERMOSTATO TERMOSTATO A TUBO-3 CALEF. A MOTOR CALEF. A TUBO-1	PRESION PRES. A LA CAJA DE DIR  S/AA S/AA  SIN LLAVE REGULAR CON LLAVE REGULAR (15 lbs) Sin palanca  180°F Re-usar el restrictor de flujo
4 CIL, 2.3 L	2002	31636 31782	TAPON DE GASOLINA TAPON DE GASOLINA	SIN LLAVE REGULAR CON LLAVE REGULAR		4 CIL, 2.4 L	1999	19704 19741	CALEF. A MOTOR CALEF. A TUBO-1	180°F Re-usar el restrictor de flujo

															
4 CIL, 2.2 L	1999	80051	EDH	PRESION	4 CIL, 2.3 L	1997	31636	TAPON DE GASOLINA	31636	TAPON DE GASOLINA	SIN LLAVE REGULAR				
		91804	EDH	RETORNO			31782	TAPON DE GASOLINA				CON LLAVE REGULAR			
		22343	MANGUERA INF.	S/AA			362810(800)	EDH				PRES. A LA CAJA DE DIR			
		22342	MANGUERA SUP.	S/AA			362810(800)	EDH				PRESION			
		38015	POLEA DEL TENSOR				22148	MANGUERA INF.							
		38011	POLEA LOCA				CH-140511	MANGUERA SUP.							
		K050887	SERPENTIN	C/AA			38011	POLEA DEL TENSOR							
		K050630	SERPENTIN	S/AA			K050474	SERPENTIN							
		31111	TAPON DE ACEITE				31120	TAPON DE ACEITE							
		31636	TAPON DE GASOLINA	SIN LLAVE REGULAR			31636	TAPON DE GASOLINA				SIN LLAVE REGULAR			
		31636	TAPON DE GASOLINA	SIN LLAVE REGULAR			31636	TAPON DE GASOLINA				SIN LLAVE REGULAR			
		31782	TAPON DE GASOLINA	CON LLAVE REGULAR			31782	TAPON DE GASOLINA				CON LLAVE REGULAR			
		31532	TAPON DE RADIADOR	(15 lbs) Sin palanca			31782	TAPON DE GASOLINA				CON LLAVE REGULAR			
		38164	TENSOR MICRO-V				31405	TAPON DE RADIADOR				(15 lbs) Sin palanca			
		33828	TERMOSTATO	180°F			38146	TENSOR MICRO-V							
31636	TAPON DE GASOLINA	SIN LLAVE REGULAR	33828	TERMOSTATO	180°F										
31782	TAPON DE GASOLINA	CON LLAVE REGULAR													
19704	CALEF. A MOTOR	Re-usar el restrictor de flujo													
80051	EDH	PRES. A LA CAJA DE DIR													
362810(800)	EDH	PRESION													
22148	MANGUERA INF.														
CH-140511	MANGUERA SUP.														
22152	MANGUERA SUP.														
38032	POLEA														
K050474	SERPENTIN														
K050478	SERPENTIN														
31111	TAPON DE ACEITE														
31636	TAPON DE GASOLINA	SIN LLAVE REGULAR													
31782	TAPON DE GASOLINA	CON LLAVE REGULAR													
31532	TAPON DE RADIADOR	(15 lbs) Sin palanca													
38247	TENSOR MICRO-V														
33828	TERMOSTATO	180°F													
80051	EDH	PRESION													
91804	EDH	RETORNO													
22343	MANGUERA INF.	S/AA													
22342	MANGUERA SUP.	S/AA													
38011	POLEA														
38015	POLEA DEL TENSOR														
K050887	SERPENTIN	C/AA													
K050630	SERPENTIN	S/AA													
31120	TAPON DE ACEITE														
31636	TAPON DE GASOLINA	SIN LLAVE REGULAR													
31636	TAPON DE GASOLINA	SIN LLAVE REGULAR													
31782	TAPON DE GASOLINA	CON LLAVE REGULAR													
31405	TAPON DE RADIADOR	(15 lbs) Sin palanca													
38164	TENSOR MICRO-V														
33828	TERMOSTATO	180°F													
31636	TAPON DE GASOLINA	SIN LLAVE REGULAR													
31782	TAPON DE GASOLINA	CON LLAVE REGULAR													
362810(800)	EDH	PRESION													
362810(800)	EDH	PRESION													
22148	MANGUERA INF.														
CH-140511	MANGUERA SUP.														
38011	POLEA														
K050474	SERPENTIN														
31111	TAPON DE ACEITE														
31636	TAPON DE GASOLINA	SIN LLAVE REGULAR													
31636	TAPON DE GASOLINA	SIN LLAVE REGULAR													
31782	TAPON DE GASOLINA	CON LLAVE REGULAR													
31405	TAPON DE RADIADOR	(15 lbs) Sin palanca													
38164	TENSOR MICRO-V														
33828	TERMOSTATO	180°F													
91804	EDH	RETORNO													
80051	EDH	PRESION													
38026	POLEA TENSORA														
K050835	SERPENTIN	C/AA													
K050705	SERPENTIN	S/AA													
31120	TAPON DE ACEITE														
31636	TAPON DE GASOLINA	SIN LLAVE REGULAR													
31636	TAPON DE GASOLINA	SIN LLAVE REGULAR													
31782	TAPON DE GASOLINA	CON LLAVE REGULAR													
31405	TAPON DE RADIADOR	(15 lbs) Sin palanca													
38110	TENSOR MICRO-V														
33828	TERMOSTATO	180°F													
<b>TORRENT</b>															
V-6, 3.4 L	2008	19026	MANGUERA DE PASO	V-6, 3.4 L	2007	19026	MANGUERA DE PASO	V-6, 3.4 L	2006	19026	MANGUERA DE PASO				
		23020	MANGUERA INF.			23020	MANGUERA INF.			23020	MANGUERA INF.				
		23137	MANGUERA SUP.			23137	MANGUERA SUP.			23137	MANGUERA SUP.				
		38009	POLEA			38009	POLEA			38009	POLEA				
		38043	POLEA			38043	POLEA			38043	POLEA				
		K060905	SERPENTIN			K060905	SERPENTIN			K060905	SERPENTIN				
		31103	TAPON DE ACEITE			31103	TAPON DE ACEITE			31103	TAPON DE ACEITE				
		31844	TAPON DE GASOLINA			31844	TAPON DE GASOLINA			31844	TAPON DE GASOLINA				
		31843	TAPON DE GASOLINA			31844	TAPON DE GASOLINA			31844	TAPON DE GASOLINA				
		31532	TAPON DE RADIADOR			31532	TAPON DE RADIADOR			31532	TAPON DE RADIADOR				
		38104	TENSOR MICRO-V			38104	TENSOR MICRO-V			38104	TENSOR MICRO-V				
		33329	TERMOSTATO			33329	TERMOSTATO			33329	TERMOSTATO				
		19026	MANGUERA DE PASO			19026	MANGUERA DE PASO			19026	MANGUERA DE PASO				
		23020	MANGUERA INF.			23020	MANGUERA INF.			23020	MANGUERA INF.				
		23137	MANGUERA SUP.			23137	MANGUERA SUP.			23137	MANGUERA SUP.				
38043	POLEA	38043	POLEA	38043	POLEA										
38009	POLEA	38009	POLEA	38009	POLEA										
K060905	SERPENTIN	K060905	SERPENTIN	K060905	SERPENTIN										
31103	TAPON DE ACEITE	31103	TAPON DE ACEITE	31103	TAPON DE ACEITE										
31844	TAPON DE GASOLINA	31844	TAPON DE GASOLINA	31844	TAPON DE GASOLINA										
31843	TAPON DE GASOLINA	31843	TAPON DE GASOLINA	31843	TAPON DE GASOLINA										
31532	TAPON DE RADIADOR	31532	TAPON DE RADIADOR	31532	TAPON DE RADIADOR										
38104	TENSOR MICRO-V	38104	TENSOR MICRO-V	38104	TENSOR MICRO-V										
33329	TERMOSTATO	33329	TERMOSTATO	33329	TERMOSTATO										
19026	MANGUERA DE PASO	19026	MANGUERA DE PASO	19026	MANGUERA DE PASO										
23020	MANGUERA INF.	23020	MANGUERA INF.	23020	MANGUERA INF.										
23137	MANGUERA SUP.	23137	MANGUERA SUP.	23137	MANGUERA SUP.										
38043	POLEA	38043	POLEA	38043	POLEA										
38009	POLEA	38009	POLEA	38009	POLEA										
K060905	SERPENTIN	K060905	SERPENTIN	K060905	SERPENTIN										
31103	TAPON DE ACEITE	31103	TAPON DE ACEITE	31103	TAPON DE ACEITE										
31844	TAPON DE GASOLINA	31844	TAPON DE GASOLINA	31844	TAPON DE GASOLINA										
31843	TAPON DE GASOLINA	31843	TAPON DE GASOLINA	31843	TAPON DE GASOLINA										
31532	TAPON DE RADIADOR	31532	TAPON DE RADIADOR	31532	TAPON DE RADIADOR										
38104	TENSOR MICRO-V	38104	TENSOR MICRO-V	38104	TENSOR MICRO-V										
33329	TERMOSTATO	33329	TERMOSTATO	33329	TERMOSTATO										
<b>TRANS AM FIREBIRD</b>															
V-8, 5.7 L	2001	K040410	A.A.	V-8, 5.7 L	2000	K040410	A.A.	V-8, 5.7 L	1999	K040410	A.A.				
		K060790	SERPENTIN			K060790	SERPENTIN			K060790	SERPENTIN				
		K040410	A.A.			K040410	A.A.			K040410	A.A.				
		22354	MANGUERA INF.			22354	MANGUERA INF.			22354	MANGUERA INF.				
		22353	MANGUERA SUP.			22353	MANGUERA SUP.			22353	MANGUERA SUP.				
		K060790	SERPENTIN			K060790	SERPENTIN			K060790	SERPENTIN				
		K040410	A.A.			K040410	A.A.			K040410	A.A.				
		22354	MANGUERA INF.			22354	MANGUERA INF.			22354	MANGUERA INF.				
		22353	MANGUERA SUP.			22353	MANGUERA SUP.			22353	MANGUERA SUP.				
		K060790	SERPENTIN			K060790	SERPENTIN			K060790	SERPENTIN				
		K040410	A.A.			K040410	A.A.			K040410	A.A.				
		22354	MANGUERA INF.			22354	MANGUERA INF.			22354	MANGUERA INF.				
		22353	MANGUERA SUP.			22353	MANGUERA SUP.			22353	MANGUERA SUP.				
		K060790	SERPENTIN			K060790	SERPENTIN			K060790	SERPENTIN				
		22263	MANGUERA INF.			22263	MANGUERA INF.			22263	MANGUERA INF.				
21439	MANGUERA SUP.	21439	MANGUERA SUP.	21439	MANGUERA SUP.										
K060642	SERPENTIN	K060642	SERPENTIN	K060642	SERPENTIN										





**PORSCHE**

**911**

6 CIL, 3.6 L	2002	K060832	SERPENTIN	
6 CIL, 3.4 L	2001	K060832	SERPENTIN	
6 CIL, 3.4 L	2000	37014P	POLEA DECOPLADORA	
		K060832	SERPENTIN	
6 CIL, 3.4 L	1999	K060832	SERPENTIN	
6 CIL, 3.6 L	1998	8430 GS	A.A.	
		7300	ALT.	
		T290	BANDA ARBOL DE LEVAS	{76 D x 25.0 mm}

**BOXSTER**

6 CIL, 2.7 L	2006	37014P	POLEA DECOPLADORA	
		K060760	SERPENTIN	SIN A.A.
		K060832	SERPENTIN	CON A.A.
		33950	TERMOSTATOS	180°
6 CIL, 3.2 L	2006	37014P	POLEA DECOPLADORA	
6 CIL, 2.7 L	2005	37014P	POLEA DECOPLADORA	
		K060832	SERPENTIN	CON A.A.
		K060760	SERPENTIN	SIN A.A.
		33950	TERMOSTATOS	180°
6 CIL, 3.2 L	2005	37014P	POLEA DECOPLADORA	
6 CIL, 2.7 L	2004	37014P	POLEA DECOPLADORA	
		K060832	SERPENTIN	CON A.A.
		K060760	SERPENTIN	SIN A.A.
		33950	TERMOSTATOS	180°
6 CIL, 3.2 L	2004	37014P	POLEA DECOPLADORA	
6 CIL, 2.7 L	2003	37014P	POLEA DECOPLADORA	
		K060760	SERPENTIN	SIN A.A.
		K060832	SERPENTIN	CON A.A.
		33950	TERMOSTATOS	180°
6 CIL, 3.2 L	2003	37014P	POLEA DECOPLADORA	
6 CIL, 2.7 L	2002	37014P	POLEA DECOPLADORA	
		K060760	SERPENTIN	S/AA
		K060832	SERPENTIN	C/AA
6 CIL, 3.2 L	2002	37014P	POLEA DECOPLADORA	
		K060760	SERPENTIN	S/AA
		K060832	SERPENTIN	C/AA
6 CIL, 2.7 L	2001	37014P	POLEA DECOPLADORA	
		K060832	SERPENTIN	C/AA
		K060760	SERPENTIN	S/AA
6 CIL, 3.2 L	2001	37014P	POLEA DECOPLADORA	
		K060760	SERPENTIN	S/AA
		K060832	SERPENTIN	C/AA
6 CIL, 2.5 L	2000	K060832	SERPENTIN	C/AA, C/DH
6 CIL, 2.7 L	2000	37014P	POLEA DECOPLADORA	
		K060832	SERPENTIN	C/AA
		K060760	SERPENTIN	S/AA
6 CIL, 3.2 L	2000	37014P	POLEA DECOPLADORA	
		K060760	SERPENTIN	S/AA
		K060832	SERPENTIN	C/AA
6 CIL, 2.5 L	1999	K060760	SERPENTIN	S/AA, C/DH
		K060832	SERPENTIN	C/AA, C/DH

**RENAULT**

**CLIO**

4 CIL, 1.6 L	2009	T1095	BANDA ARBOL DE LEVAS	132 D X 27MM
		TCK1095	KIT DE DISTRIBUCION	
		CH-180182	MANGUERA INF.	
		CH-180191	MANGUERA SUP.	
		T41237	POLEA DE DISTRIBUCION	
		K050435	SERPENTIN	SIN A.A.
		K050688	SERPENTIN	CON A.A.
		T38456	TENSOR	CON A.A.
		T43064	TENSOR	

4 CIL, 1.6 L	2008	T38484	TENSOR	SIN A.A.
		TH23389G1	TERMOSTATOS	
		T1095	BANDA ARBOL DE LEVAS	{132 D x 27 mm}
		TCK1095	KIT DE DISTRIBUCION	
		CH-180182	MANGUERA INF.	
		CH-180191	MANGUERA SUP.	
		T41237	POLEA DE DISTRIBUCION	
		K050435	SERPENTIN	SIN A.A.
		K050688	SERPENTIN	CON A.A.
		T38484	TENSOR	SIN A.A.
		T38456	TENSOR	CON A.A.
		T43064	TENSOR ARBOL DE LEVAS	
		TH23389G1	TERMOSTATO	190°F
		T1095	BANDA ARBOL DE LEVAS	{132 D x 27 mm}
		TCK1095	KIT DE DISTRIBUCION	
		CH-180182	MANGUERA INF.	
		CH-180191	MANGUERA SUP.	
		T41237	POLEA DE DISTRIBUCION	
		K050688	SERPENTIN	CON A.A.
		K050435	SERPENTIN	SIN A.A.
		T38484	TENSOR	SIN A.A.
		T38456	TENSOR	CON A.A.
		T43064	TENSOR ARBOL DE LEVAS	
		TH23389G1	TERMOSTATO	190°F
		T1095	BANDA ARBOL DE LEVAS	{132 D x 27 mm}
		TCK1095	KIT DE DISTRIBUCION	
		CH-180182	MANGUERA INF.	
		CH-180191	MANGUERA SUP.	
		T41237	POLEA DE DISTRIBUCION	
		K050435	SERPENTIN	SIN A.A.
		K050688	SERPENTIN	CON A.A.
		T38456	TENSOR	CON A.A.
		T38484	TENSOR	SIN A.A.
		T43064	TENSOR ARBOL DE LEVAS	
		TH23389G1	TERMOSTATO	190°F
		T1284	BANDA ARBOL DE LEVAS	{128 D x 27 mm}
		T42166	POLEA LOCA DISTRIBUCION	
		K060653	SERPENTIN	
		TPG-20001	TENSOR ARBOL DE LEVAS	
		TH23389G1	TERMOSTATO	190°F
		T1095	BANDA ARBOL DE LEVAS	{132 D x 27 mm}
		TCK1095	KIT DE DISTRIBUCION	
		CH-180182	MANGUERA INF.	
		CH-180191	MANGUERA SUP.	
		T41237	POLEA DE DISTRIBUCION	
		K050688	SERPENTIN	CON A.A.
		K050435	SERPENTIN	SIN A.A.
		T38484	TENSOR	SIN A.A.
		T38456	TENSOR	CON A.A.
		T43064	TENSOR ARBOL DE LEVAS	
		TH23389G1	TERMOSTATO	190°F
		T1284	BANDA ARBOL DE LEVAS	{128 D x 27 mm}
		T42166	POLEA LOCA DISTRIBUCION	
		K060653	SERPENTIN	
		TPG-20001	TENSOR ARBOL DE LEVAS	
		TH23389G1	TERMOSTATO	190°F
		T1095	BANDA ARBOL DE LEVAS	{132 D x 27 mm}
		TCK1095	KIT DE DISTRIBUCION	
		CH-180182	MANGUERA INF.	
		CH-180191	MANGUERA SUP.	
		T41237	POLEA DE DISTRIBUCION	
		K050688	SERPENTIN	CON A.A.
		K050435	SERPENTIN	SIN A.A.
		T38484	TENSOR	SIN A.A.
		T38456	TENSOR	CON A.A.
		T43064	TENSOR ARBOL DE LEVAS	
		TH23389G1	TERMOSTATO	190°F
		T1284	BANDA ARBOL DE LEVAS	{128 D x 27 mm}
		T42166	POLEA LOCA DISTRIBUCION	
		K060653	SERPENTIN	
		TPG-20001	TENSOR ARBOL DE LEVAS	
		TH23389G1	TERMOSTATO	190°F
		T1095	BANDA ARBOL DE LEVAS	{132 D x 27 mm}
		TCK1095	KIT DE DISTRIBUCION	
		CH-180182	MANGUERA INF.	

4 CIL, 1.6 L	2003	CH-180191 T41237 K050688 K050435 T38484 T38456 T43064 TH23389G1	MANGUERA SUP. POLEA DE DISTRIBUCION SERPENTIN SERPENTIN TENSOR TENSOR TENSOR ARBOL DE LEVAS TERMOSTATO	CON A.A. SIN A.A. SIN A.A. CON A.A.  190°F {128 D x 27 mm}
4 CIL, 2.0 L SPORT	2003	T1284 T42166 K060653 TPG-20001 TH23389G1	BANDA ARBOL DE LEVAS POLEA LOCA DISTRIBUCION SERPENTIN TENSOR ARBOL DE LEVAS TERMOSTATO	190°F    190°F

4 CIL, 1.6 L	2005	CH-180191 T41237 K050688 K050435 T38456 T38484 T43064 TH23389G1	MANGUERA SUP. POLEA DE DISTRIBUCION SERPENTIN SERPENTIN TENSOR TENSOR TENSOR ARBOL DE LEVAS TERMOSTATO	CON A.A. SIN A.A. SIN A.A. CON A.A. SIN A.A.  190°F {132 D x 27 mm}
4 CIL, 1.6 L	2004	T1095 TCK1095 CH-180182 CH-180191 T41237 K050688 K050435 T38484 T38456 T43064 TH23389G1	BANDA ARBOL DE LEVAS KIT DE DISTRIBUCION MANGUERA INF. MANGUERA SUP. POLEA DE DISTRIBUCION SERPENTIN SERPENTIN TENSOR TENSOR TENSOR ARBOL DE LEVAS TERMOSTATO	190°F        190°F
4 CIL, 1.6 L	2003	T41237 T38456 T38484 T41237 T38456 T38484	POLEA DE DISTRIBUCION TENSOR TENSOR POLEA DE DISTRIBUCION TENSOR TENSOR	CON A.A. SIN A.A. CON A.A. CON A.A. SIN A.A.

**EUROCLIO**

4 CIL, 1.6 L	2008	T1095 TCK1095 T41237 K060472 T43064	BANDA ARBOL DE LEVAS KIT DE DISTRIBUCION POLEA DE DISTRIBUCION SERPENTIN TENSOR	{132 D x 27 mm}
4 CIL, 1.6 L	2007	T1095 TCK1095 T41237 K060472 T43064	BANDA ARBOL DE LEVAS KIT DE DISTRIBUCION POLEA DE DISTRIBUCION SERPENTIN TENSOR	{132 D x 27 mm}

**KANGOO**

4 CIL, 1.6 L	2010	T1095 TCK1095 CH-180182 CH-180191 T41237 K050688 K050435 T43064 T38484 T38456 TH23389G1	BANDA ARBOL DE LEVAS KIT DE DISTRIBUCION MANGUERA INF. MANGUERA SUP. POLEA DE DISTRIBUCION SERPENTIN SERPENTIN TENSOR TENSOR TENSOR TERMOSTATOS	132 D X 27MM  CON A.A. SIN A.A.  SIN A.A. CON A.A. CON A.A.
4 CIL, 1.6 L	2009	T1095 TCK1095 CH-180182 CH-180191 T41237 K050435 K050688 T38456 T38484 T43064 TH23389G1	BANDA ARBOL DE LEVAS KIT DE DISTRIBUCION MANGUERA INF. MANGUERA SUP. POLEA DE DISTRIBUCION SERPENTIN SERPENTIN TENSOR TENSOR TENSOR TERMOSTATOS	132 D X 27MM  SIN A.A. CON A.A. CON A.A. SIN A.A.
4 CIL, 1.6 L	2008	T1095 TCK1095 CH-180182 CH-180191 T41237 K050688 K050435 T38484 T38456 T43064 TH23389G1	BANDA ARBOL DE LEVAS KIT DE DISTRIBUCION MANGUERA INF. MANGUERA SUP. POLEA DE DISTRIBUCION SERPENTIN SERPENTIN TENSOR TENSOR ARBOL DE LEVAS TERMOSTATO	{132 D x 27 mm}  CON A.A. SIN A.A. CON A.A.
4 CIL, 1.6 L	2007	T1095 TCK1095 CH-180182 CH-180191 T41237 K050435 K050688 T38456 T38484 T43064 TH23389G1	BANDA ARBOL DE LEVAS KIT DE DISTRIBUCION MANGUERA INF. MANGUERA SUP. POLEA DE DISTRIBUCION SERPENTIN SERPENTIN TENSOR TENSOR ARBOL DE LEVAS TERMOSTATO	190°F {132 D x 27 mm}  SIN A.A. CON A.A. CON A.A. SIN A.A.
4 CIL, 1.6 L	2006	T1095 TCK1095 CH-180182 CH-180191 T41237 K050435 K050688 T38456 T38484 T43064 TH23389G1	BANDA ARBOL DE LEVAS KIT DE DISTRIBUCION MANGUERA INF. MANGUERA SUP. POLEA DE DISTRIBUCION SERPENTIN SERPENTIN TENSOR TENSOR ARBOL DE LEVAS TERMOSTATO	190°F {132 D x 27 mm}

**KANGOO EXPRESS**

4 CIL, 1.6 L	2009	T1095 TCK1095 CH-180182 CH-180191 T41237 K050688 K050435 T43064 T38484 T38456 TH23389G1	BANDA ARBOL DE LEVAS KIT DE DISTRIBUCION MANGUERA INF. MANGUERA SUP. POLEA DE DISTRIBUCION SERPENTIN SERPENTIN TENSOR TENSOR TENSOR TERMOSTATOS	132 D X 27MM  CON A.A. SIN A.A.  SIN A.A. CON A.A. CON A.A.
4 CIL, 1.6 L	2008	T1095 TCK1095 CH-180182 CH-180191 T41237 K050435 K050688 T38456 T38484 T43064 TH23389G1	BANDA ARBOL DE LEVAS KIT DE DISTRIBUCION MANGUERA INF. MANGUERA SUP. POLEA DE DISTRIBUCION SERPENTIN SERPENTIN TENSOR TENSOR TENSOR ARBOL DE LEVAS TERMOSTATOS	{132 D x 27 mm}  SIN A.A. CON A.A. CON A.A. SIN A.A.
4 CIL, 1.6 L	2007	T1095 TCK1095 CH-180182 CH-180191 T41237 K050435 K050688 T38456 T38484 T43064 TH23389G1	BANDA ARBOL DE LEVAS KIT DE DISTRIBUCION MANGUERA INF. MANGUERA SUP. POLEA DE DISTRIBUCION SERPENTIN SERPENTIN TENSOR TENSOR ARBOL DE LEVAS TERMOSTATO	190°F {132 D x 27 mm}  SIN A.A. CON A.A. CON A.A. SIN A.A.
4 CIL, 1.6 L	2006	T1095 TCK1095 CH-180182 CH-180191 T41237 K050435 K050688 T38456 T38484 T43064 TH23389G1	BANDA ARBOL DE LEVAS KIT DE DISTRIBUCION MANGUERA INF. MANGUERA SUP. POLEA DE DISTRIBUCION SERPENTIN SERPENTIN TENSOR TENSOR ARBOL DE LEVAS TERMOSTATO	190°F {132 D x 27 mm}
4 CIL, 1.6 L	2005	T1095 TCK1095	BANDA ARBOL DE LEVAS KIT DE DISTRIBUCION	190°F {132 D x 27 mm}

4 CIL, 1.6 L	2005	CH-180182 CH-180191 T41237 K050688 K050435 T38484 T38456 T43064 TH23389G1	MANGUERA INF. MANGUERA SUP. POLEA DE DISTRIBUCION SERPENTIN SERPENTIN TENSOR TENSOR TENSOR ARBOL DE LEVAS TERMOSTATO	CON A.A. SIN A.A. CON A.A. 190°F

4 CIL, 2.0 L	2004	TPG-20001 TH23389G1 T42167 K070443 T38428 T1565 T42166 TPG-20001 TH23389G1	TENSOR ARBOL DE LEVAS TERMOSTATO POLEA DE DISTRIBUCION SERPENTIN TENSOR BANDA ARBOL DE LEVAS POLEA LOCA DISTRIBUCION TENSOR ARBOL DE LEVAS TERMOSTATO	190°F
4 CIL, 2.0 L	2004	T1565 T42166 TPG-20001 TH23389G1	BANDA ARBOL DE LEVAS POLEA LOCA DISTRIBUCION TENSOR ARBOL DE LEVAS TERMOSTATO	{126 D x 27 mm}
4 CIL, 2.0 L	2003	T1284 T42166 K050688 TPG-20001 TH23389G1	BANDA ARBOL DE LEVAS POLEA LOCA DISTRIBUCION SERPENTIN TENSOR ARBOL DE LEVAS TERMOSTATO	190°F {128 D x 27 mm}
4 CIL, 2.0 L	2002	T1284 T42166 K050688 TPG-20001 TH23389G1	BANDA ARBOL DE LEVAS POLEA LOCA DISTRIBUCION SERPENTIN TENSOR ARBOL DE LEVAS TERMOSTATO	190°F {128 D x 27 mm}
4 CIL, 2.0 L	2001	T1284 T42166 K050688 TPG-20001 TH23389G1	BANDA ARBOL DE LEVAS POLEA LOCA DISTRIBUCION SERPENTIN TENSOR ARBOL DE LEVAS TERMOSTATO	190°F {128 D x 27 mm}

**KOLEOS**

4 CIL, 2.5 L	2010	K060711 31115 31836 31838 33941	SERPENTIN TAPON DE ACEITE TAPON DE GASOLINA TAPON DE GASOLINA TERMOSTATOS	CON LLAVE 180°
4 CIL, 2.5 L	2009	K060711 31115 31838 31836 33941	SERPENTIN TAPON DE ACEITE TAPON DE GASOLINA TAPON DE GASOLINA TERMOSTATOS	CON LLAVE 180°

**LAGUNA**

V6, 2.4 L	2006	T1596 K060623 T43166	BANDA ARBOL DE LEVAS SERPENTIN TENSOR	
V6, 2.4 L	2005	T1596 K060623 T43166	BANDA ARBOL DE LEVAS SERPENTIN TENSOR	
4 CIL, 2.0 L	2004	TPG-20001	TENSOR ARBOL DE LEVAS	
V-6, 2.4 L	2004	K060623	SERPENTIN	C/AA
V6, 2.4 L	2004	T1596 T43166	BANDA ARBOL DE LEVAS TENSOR	
4 CIL, 2.0 L	2003	TPG-20001	TENSOR ARBOL DE LEVAS	
4 CIL, 2.0 L	2002	TPG-20001	TENSOR ARBOL DE LEVAS	
4 CIL, 2.0 L	2001	TPG-20001	TENSOR ARBOL DE LEVAS	

**SANDERO**

4 CIL, 1.6 L	2010	T1095 TKC1095 T41237 K060470 K060721 T43064	BANDA ARBOL DE LEVAS KIT DE DISTRIBUCION POLEA DE DISTRIBUCION SERPENTIN SERPENTIN TENSOR	132 D x 27MM SIN A.A. CON A.A.
--------------	------	--	--	--------------------------------------

**SCENIC**

4 CIL, 2.0 L	2009	T1565 T42166 T42167 K070443 T38428 TPG-20001 TH23389G1	BANDA ARBOL DE LEVAS POLEA DE DISTRIBUCION POLEA DE DISTRIBUCION SERPENTIN TENSOR TENSOR TERMOSTATOS	190°
4 CIL, 2.0 L	2008	T42167 K070443 T38428	POLEA DE DISTRIBUCION SERPENTIN TENSOR	
4 CIL, 2.0 L	2007	T42167 K070443 T38428	POLEA DE DISTRIBUCION SERPENTIN TENSOR	
4 CIL, 2.0 L	2007	T42167 K070443 T38428	POLEA DE DISTRIBUCION SERPENTIN TENSOR	
4 CIL, 2.0 L	2007	T42167 K070443 T38428	POLEA DE DISTRIBUCION SERPENTIN TENSOR	
4 CIL, 2.0 L	2006	T42167 K070443 T38428	POLEA DE DISTRIBUCION SERPENTIN TENSOR	
4 CIL, 2.0 L	2006	T1565 T42166 TPG-20001 TH23389G1	BANDA ARBOL DE LEVAS POLEA LOCA DISTRIBUCION TENSOR ARBOL DE LEVAS TERMOSTATO	{126 D x 27 mm}
4 CIL, 2.0 L	2006	T1565 T42166 TPG-20001 TH23389G1	BANDA ARBOL DE LEVAS POLEA LOCA DISTRIBUCION TENSOR ARBOL DE LEVAS TERMOSTATO	190°F
4 CIL, 2.0 L	2006	T1565 T42166 TPG-20001 TH23389G1	BANDA ARBOL DE LEVAS POLEA LOCA DISTRIBUCION TENSOR ARBOL DE LEVAS TERMOSTATO	{126 D x 27 mm}
4 CIL, 2.0 L	2005	T42167 K070443 T38428	POLEA DE DISTRIBUCION SERPENTIN TENSOR	
4 CIL, 2.0 L	2005	T1565 T42166 TPG-20001 TH23389G1	BANDA ARBOL DE LEVAS POLEA LOCA DISTRIBUCION TENSOR ARBOL DE LEVAS TERMOSTATO	{126 D x 27 mm}
4 CIL, 2.0 L	2005	T42167 K070443 T38428	POLEA DE DISTRIBUCION SERPENTIN TENSOR	
4 CIL, 2.0 L	2004	T42167 K070443 T38428	POLEA DE DISTRIBUCION SERPENTIN TENSOR	
4 CIL, 2.0 L	2004	T1565 T42166 TPG-20001 TH23389G1	BANDA ARBOL DE LEVAS POLEA LOCA DISTRIBUCION TENSOR ARBOL DE LEVAS TERMOSTATO	{126 D x 27 mm}
4 CIL, 2.0 L	2004	T1565 T42166 TPG-20001 TH23389G1	BANDA ARBOL DE LEVAS POLEA LOCA DISTRIBUCION TENSOR ARBOL DE LEVAS TERMOSTATO	190°F
4 CIL, 2.0 L	2003	T1284 T42166	BANDA ARBOL DE LEVAS POLEA LOCA DISTRIBUCION	{128 D x 27 mm}

**MEGANE**

4 CIL, 2.0 L	2009	T1565 T42167 T42166 K070443 TPG-20001 T38428 TH23389G1	BANDA ARBOL DE LEVAS POLEA DE DISTRIBUCION POLEA DE DISTRIBUCION SERPENTIN TENSOR TENSOR TERMOSTATOS	190°
4 CIL, 1.6 L	2008	T1095 K060472	BANDA ARBOL DE LEVAS SERPENTIN	{132 D x 27 mm}
4 CIL, 2.0 L	2008	T42167 K070443 T38428	POLEA DE DISTRIBUCION SERPENTIN TENSOR	
4 CIL, 2.0 L	2008	T1565 T42166 TPG-20001 TH23389G1	BANDA ARBOL DE LEVAS POLEA LOCA DISTRIBUCION TENSOR ARBOL DE LEVAS TERMOSTATO	{126 D x 27 mm}
4 CIL, 2.0 L	2007	T42167 K070443 T38428	POLEA DE DISTRIBUCION SERPENTIN TENSOR	190°F
4 CIL, 2.0 L	2007	T1565 T42166 TPG-20001 TH23389G1	BANDA ARBOL DE LEVAS POLEA LOCA DISTRIBUCION TENSOR ARBOL DE LEVAS TERMOSTATO	{126 D x 27 mm}
4 CIL, 2.0 L	2006	T42167 K070443 T38428	POLEA DE DISTRIBUCION SERPENTIN TENSOR	190°F
4 CIL, 2.0 L	2006	T1565 T42166 TPG-20001 TH23389G1	BANDA ARBOL DE LEVAS POLEA LOCA DISTRIBUCION TENSOR ARBOL DE LEVAS TERMOSTATO	{126 D x 27 mm}
4 CIL, 2.0 L	2005	T42167 K070443 T38428	POLEA DE DISTRIBUCION SERPENTIN TENSOR	190°F
4 CIL, 2.0 L	2005	T1565 T42166 TPG-20001 TH23389G1	BANDA ARBOL DE LEVAS POLEA LOCA DISTRIBUCION TENSOR ARBOL DE LEVAS TERMOSTATO	{126 D x 27 mm}

4 CIL, 2.0 L	2003	K050688 TPG-20001 TH23389G1	SERPENTIN TENSOR ARBOL DE LEVAS TERMOSTATO	190°F
4 CIL, 2.0 L	2002	T1284 T42166 K050688 TPG-20001 TH23389G1	BANDA ARBOL DE LEVAS POLEA LOCA DISTRIBUCION SERPENTIN TENSOR ARBOL DE LEVAS TERMOSTATO	{128 D x 27 mm}
4 CIL, 2.0 L	2001	T1284 T42166 K050688 TPG-20001 TH23389G1	BANDA ARBOL DE LEVAS POLEA LOCA DISTRIBUCION SERPENTIN TENSOR ARBOL DE LEVAS TERMOSTATO	190°F {128 D x 27 mm}
				190°F

4 CIL, 2.0 L	2003	K050405 38177 38177 33189	SERPENTIN TENSOR TENSOR MICRO-V TERMOSTATOS	195°F
				VIN K
				VIN S & Y
				VIN S & Y REQUIERE CONE
				VIN K
				MOTOR. VIN S, Y
				MOTOR. VIN S, Y
				MOTOR. VIN K

**STEPWAY**

4 CIL, 1.6 L	2010	T1095 TCK1095 T41237 K060721 K060470 T43064	BANDA ARBOL DE LEVAS KIT DE DISTRIBUCION POLEA DE DISTRIBUCION SERPENTIN SERPENTIN TENSOR	132 D X 27MM  CON A.A. SIN A.A.
--------------	------	--	--	--

**TRAFIC**

4 CIL, 1.9 L DIESEL	2010	T1558 K050446 K060708 T41240	BANDA ARBOL DE LEVAS SERPENTIN SERPENTIN TENSOR	132 D X 26 MM CON A.A. SIN A.A.
4 CIL, 1.9 L DIESEL	2009	T1558 K060708 K050446 T41240	BANDA ARBOL DE LEVAS SERPENTIN SERPENTIN TENSOR	132 D X 26 MM SIN A.A. CON A.A.
4 CIL, 1.9 L DIESEL	2008	T1558 K060708 K050446 T41240	BANDA ARBOL DE LEVAS SERPENTIN SERPENTIN TENSOR	{132 D x 26 mm} SIN A.A. CON A.A.

**SAAB**

**9 - 3**

4 CIL, 2.0 L	2007	22937 21591 K050405 38177 33189	MANGUERA INF. MANGUERA SUP. SERPENTIN TENSOR TERMOSTATOS	REQUIERE CONECTOR  195°F
V-6, 2.8 L	2007	K060837 31103 31852 31855 38397	SERPENTIN TAPON DE ACEITE TAPON DE GASOLINA TAPON DE GASOLINA TENSOR	CON LLAVE
4 CIL, 2.0 L	2006	22937 21591 38011 K050405 38177 38177 33189	MANGUERA INF. MANGUERA SUP. POLEA SERPENTIN TENSOR TENSOR MICRO-V TERMOSTATOS	REQUIERE CONECTOR  -
V-6, 2.8 L	2006	K060837 31103 31855 31852 38397	SERPENTIN TAPON DE ACEITE TAPON DE GASOLINA TAPON DE GASOLINA TENSOR	195°F
4 CIL, 2.0 L	2005	22937 21591 38011 K050405 38177 38177 33189	MANGUERA INF. MANGUERA SUP. POLEA SERPENTIN TENSOR TENSOR MICRO-V TERMOSTATOS	REQUIERE CONECTOR  -
4 CIL, 2.0 L	2004	22937 21591 38011	MANGUERA INF. MANGUERA SUP. POLEA	195°F REQUIERE CONECTOR -

**9 - 5**

4 CIL, 2.3 L	2007	22932 22936 36079 K060956 31297 31843 31844 31548 38226 33189	MANGUERA INF. MANGUERA SUP. POLEA SERPENTIN TAPON DE ACEITE TAPON DE GASOLINA TAPON DE GASOLINA TAPONES DE RADIADOR TENSOR TERMOSTATOS	CON LLAVE
4 CIL, 2.3 L	2006	22932 22936 36079 K060956	MANGUERA INF. MANGUERA SUP. POLEA SERPENTIN	195°F



4 CIL, 2.3 L	2006	31297	TAPON DE ACEITE	
		31844	TAPON DE GASOLINA	CON LLAVE
		31843	TAPON DE GASOLINA	
		31548	TAPONES DE RADIADOR	
		38226	SENSOR	
		38226	SENSOR MICRO-V	-
		33189	TERMOSTATOS	195°F
4 CIL, 2.3 L	2005	22932	MANGUERA INF.	
		22936	MANGUERA SUP.	
		36079	POLEA	
		K060956	SERPENTIN	
		31297	TAPON DE ACEITE	
		31844	TAPON DE GASOLINA	CON LLAVE
		31843	TAPON DE GASOLINA	
		31548	TAPONES DE RADIADOR	
		38226	SENSOR	
		38226	SENSOR MICRO-V	-
		33189	TERMOSTATOS	195°F
4 CIL, 2.3 L	2004	22932	MANGUERA INF.	
		22936	MANGUERA SUP.	
		36079	POLEA	
		K060956	SERPENTIN	
		31297	TAPON DE ACEITE	
		31844	TAPON DE GASOLINA	CON LLAVE
		31843	TAPON DE GASOLINA	
		31548	TAPONES DE RADIADOR	
		38226	SENSOR	
		38226	SENSOR MICRO-V	-
		33189	TERMOSTATOS	195°F
4 CIL, 2.3 L	2003	38226	SENSOR MICRO-V	-
V-6, 3.0 L	2003	T285	BANDA ARBOL DE LEVAS	225 DIENTES X 30.0 MM
		TCK285	KIT DE DISTRIBUCION	-
		TCK285	KIT DE DISTRIBUCION	-
		TCK285	KIT DE DISTRIBUCION	-
		22932	MANGUERA INF.	
		22936	MANGUERA SUP.	
		38009	POLEA	
		38009	POLEA	
		36079	POLEA	
		31546	TAPONES DE RADIADOR	20 LIBRAS
		38226	SENSOR	
		38179	SENSOR MICRO-V	-
4 CIL, 2.3 L	2002	22932	MANGUERA INF.	
		22936	MANGUERA SUP.	
		36079	POLEA	
		K061031	SERPENTIN	
		31297	TAPON DE ACEITE	
		31832	TAPON DE GASOLINA	
		31780	TAPON DE GASOLINA	CON LLAVE
		31546	TAPONES DE RADIADOR	20 LIBRAS
		38226	SENSOR	
		38226	SENSOR MICRO-V	-
		33189	TERMOSTATOS	195°F
V-6, 3.0 L	2002	T285	BANDA ARBOL DE LEVAS	225 DIENTES X 30.0 MM
		TCK285	KIT DE DISTRIBUCION	-
		TCK285	KIT DE DISTRIBUCION	-
		22934	MANGUERA INF.	
		38009	POLEA	
		38009	POLEA	
		K060795	SERPENTIN	
		31832	TAPON DE GASOLINA	
		31780	TAPON DE GASOLINA	CON LLAVE
		38179	SENSOR	
		38179	SENSOR MICRO-V	-
		33189	TERMOSTATOS	195°F
4 CIL, 2.3 L	2001	38226	SENSOR MICRO-V	-
V-6, 3.0 L	2001	TCK285	KIT DE DISTRIBUCION	-
		38009	POLEA	-
		38179	SENSOR MICRO-V	-
4 CIL, 2.3 L	2000	38083	POLEA	Chassis No. X3022043 & ANTE
		38226	SENSOR MICRO-V	-
V-6, 3.0 L	2000	TCK285	KIT DE DISTRIBUCION	-
		38009	POLEA	-
		38179	SENSOR MICRO-V	-



## SEAT

## AHLAMBRA

4 CIL, 1.8 L	2007	T306	BANDA ARBOL DE LEVAS	
		6DPK1200	SERPENTIN	
		T43017	SENSOR ARBOL DE LEVAS	CON TORNILLO
		T43016	SENSOR ARBOL DE LEVAS	
		38148	SENSOR MICRO-V	
4 CIL, 1.8 L	2006	T306	BANDA ARBOL DE LEVAS	
		6DPK1200	SERPENTIN	
		T43017	SENSOR ARBOL DE LEVAS	CON TORNILLO
		T43016	SENSOR ARBOL DE LEVAS	
		38148	SENSOR MICRO-V	
4 CIL, 1.8 L	2005	T306	BANDA ARBOL DE LEVAS	
		6DPK1200	SERPENTIN	
		T43016	SENSOR ARBOL DE LEVAS	CON TORNILLO
		T43017	SENSOR ARBOL DE LEVAS	
		38148	SENSOR MICRO-V	
4 CIL, 1.8 L	2004	T306	BANDA ARBOL DE LEVAS	
		6DPK1200	SERPENTIN	
		T43016	SENSOR ARBOL DE LEVAS	CON TORNILLO
		T43017	SENSOR ARBOL DE LEVAS	
		38148	SENSOR MICRO-V	
4 CIL, 1.8 L	2003	T306	BANDA ARBOL DE LEVAS	
		6DPK1200	SERPENTIN	
		T43017	SENSOR ARBOL DE LEVAS	CON TORNILLO
		T43016	SENSOR ARBOL DE LEVAS	
		38148	SENSOR MICRO-V	

## ALTEA





4 CIL, 2.0 L	2008	T334	BANDA ARBOL DE LEVAS	
		T42019	POLEA LOCA DISTRIBUCION	
		K060380	SERPENTIN	SIN A.A.
		K060415	SERPENTIN	CON A.A.
		T43142	SENSOR ARBOL DE LEVAS	
4 CIL, 2.0 L	2007	T334	BANDA ARBOL DE LEVAS	
		T42019	POLEA LOCA DISTRIBUCION	
		K060415	SERPENTIN	CON A.A.
		K060380	SERPENTIN	SIN A.A.
		T43142	SENSOR ARBOL DE LEVAS	
4 CIL, 2.0 L	2006	T334	BANDA ARBOL DE LEVAS	
		T42019	POLEA LOCA DISTRIBUCION	
		K060415	SERPENTIN	CON A.A.
		K060380	SERPENTIN	SIN A.A.
		T43142	SENSOR ARBOL DE LEVAS	



## CORDOBA

4 CIL, 1.6 L	2008	T1548	BANDA ARBOL DE LEVAS	
		TCK1548	KIT DE DISTRIBUCION	
		CH-220782	MANGUERA INF.	
		CH-220871	MANGUERA SUP.	
		K060295	SERPENTIN	
		K060424	SERPENTIN	
		TMV-23001	SENSOR	
		TPG-23001	SENSOR	
4 CIL, 1.6 L	2007	T1548	BANDA ARBOL DE LEVAS	
		TCK1548	KIT DE DISTRIBUCION	
		CH-220782	MANGUERA INF.	
		CH-220871	MANGUERA SUP.	
		TMV-23001	SERPENTIN	
		K060295	SERPENTIN	SIN A.A.
		TPG-23001	SENSOR ARBOL DE LEVAS	
4 CIL, 2.0 L	2007	T296	BANDA ARBOL DE LEVAS	138 D X 23MM
		TCK296	KIT DE DISTRIBUCION	
		K060363	SERPENTIN	SIN A.A.
		K060406	SERPENTIN	CON A.A.
		T43010	SENSOR	
		38148	SENSOR	
4 CIL, 1.6 L	2006	T1548	BANDA ARBOL DE LEVAS	
		TCK1548	KIT DE DISTRIBUCION	





				
4 CIL, 2.0 L	2003	K060406 K060363 T43010 38148	SERPENTIN SERPENTIN TENSOR TENSOR	CON A.A. SIN A.A.

				
6 CIL, 3.0 L	2007	23172 21404 23174 K060637 31119 31838 31411 33478	MANG. INF. MANG. SUP. MANG. SUP. SERPENTIN TAPON DE ACEITE TAPON DE GASOLINA TAPON DE RADIADOR TERMOSTATO	LADO PASAJERO LADO CONDUCTOR  SIN LLAVE REGULAR (13 lbs) Sin palanca 180°F
6 CIL, 3.0 L	2006	23172 21404 23174 K060637 31119 31838 31411 33478	MANG. INF. MANG. SUP. MANG. SUP. SERPENTIN TAPON DE ACEITE TAPON DE GASOLINA TAPON DE RADIADOR TERMOSTATO	LADO PASAJERO LADO CONDUCTOR  SIN LLAVE REGULAR (13 lbs) Sin palanca 180°F

**LEON**

4 CIL, 2.0 L	2007	T334 T42019 K060380 K060415 T43142	BANDA ARBOL DE LEVAS POLEA LOCA DISTRIBUCION SERPENTIN SERPENTIN TENSOR ARBOL DE LEVAS	SIN A.A. CON A.A.
4 CIL, 2.0 L	2006	T334 T42019 K060380 K060415 T43142	BANDA ARBOL DE LEVAS POLEA LOCA DISTRIBUCION SERPENTIN SERPENTIN TENSOR ARBOL DE LEVAS	SIN A.A. CON A.A.
4 CIL, 1.8 L	2005	T306 6DPK1200 K060445 T43017 38148	BANDA ARBOL DE LEVAS SERPENTIN SERPENTIN TENSOR ARBOL DE LEVAS TENSOR MICRO-V	CON A.A. SIN A.A.
4 CIL, 1.8 L	2004	T306 6DPK1200 K060445 T43017 38148	BANDA ARBOL DE LEVAS SERPENTIN SERPENTIN TENSOR ARBOL DE LEVAS TENSOR MICRO-V	CON A.A. SIN A.A.
4 CIL, 1.8 L	2003	T306 T43017 38148	BANDA ARBOL DE LEVAS TENSOR ARBOL DE LEVAS TENSOR MICRO-V	

**FORESTER**

4 CIL, 2.5 L	2007	T328 T304 22498 22553 20953 38030 K050345 K040353 31119 31832 31336	BANDA ARBOL DE LEVAS BANDA ARBOL DE LEVAS MANG. INF. MANG. INF. MANG. SUP. POLEA LOCA SERPENTIN SERPENTIN TAPON DE ACEITE TAPON DE GASOLINA TAPON DE RADIADOR	DOHC SOCH DOHC SOCH  A.A. ALT. / D.H. A.A.
4 CIL, 2.5 L	2006	T304 T328 22498 22553 20953 38030 T42024 T42023 K050345 K040353 31119 31832 31336	BANDA ARBOL DE LEVAS BANDA ARBOL DE LEVAS MANG. INF. MANG. INF. MANG. SUP. POLEA POLEA BANDA DE TIEMPO POLEA BANDA DE TIEMPO SERPENTIN SERPENTIN TAPON DE ACEITE TAPON DE GASOLINA TAPON DE RADIADOR	SIN LLAVE REGULAR (16 lbs) Sin Palanca SOCH DOHC (281 D x 29 mm) DOHC SOCH  A.A. INFERIOR MANO IZQUIERDA ALT. / D.H. A.A. SIN LLAVE REGULAR (16 lbs) Sin Palanca

**TOLEDO**

4 CIL, 2.0 L	2007	T334 T42019 K060380 K060415 T43142	BANDA ARBOL DE LEVAS POLEA LOCA DISTRIBUCION SERPENTIN SERPENTIN TENSOR ARBOL DE LEVAS	SIN A.A. CON A.A.
4 CIL, 2.0 L	2006	T334 T42019 K060380 K060415 T43142	BANDA ARBOL DE LEVAS POLEA LOCA DISTRIBUCION SERPENTIN SERPENTIN TENSOR ARBOL DE LEVAS	SIN A.A. CON A.A.
4 CIL, 1.8 L	2005	T306 6DPK1200 K060445 T43017 38148	BANDA ARBOL DE LEVAS SERPENTIN SERPENTIN TENSOR ARBOL DE LEVAS TENSOR MICRO-V	CON A.A. SIN A.A.
4 CIL, 1.8 L	2004	T306 6DPK1200 K060445 T43017 38148	BANDA ARBOL DE LEVAS SERPENTIN SERPENTIN TENSOR ARBOL DE LEVAS TENSOR MICRO-V	CON A.A. SIN A.A.
4 CIL, 1.8 L	2003	T306 T43017 38148	BANDA ARBOL DE LEVAS TENSOR ARBOL DE LEVAS TENSOR MICRO-V	

**SMART****FORTWO**

3 CIL, 0.8 L	2006	K030335 K040300	SERPENTIN SERPENTIN	SIN A.A. CON A.A.
3 CIL, 0.8 L	2005	K030335 K040300	SERPENTIN SERPENTIN	SIN A.A. CON A.A.
3 CIL, 0.8 L	2004	K030335 K040300	SERPENTIN SERPENTIN	SIN A.A. CON A.A.

**SUBARU****IMPREZA**

4 CIL, 2.5 L	2007	T304 T328 22885 22494 22886 22886 T42024 T42023 38030 K050345 K040353 31119 31832 31336 33857	BANDA ARBOL DE LEVAS BANDA ARBOL DE LEVAS MANG. INF. MANG. INF. MANG. SUP. MANG. SUP. POLEA LOCA SERPENTIN SERPENTIN TAPON DE ACEITE TAPON DE GASOLINA TAPON DE RADIADOR TERMOSTATO	SOCH DOHC DOHC SOCH  A.A. D.H. A.A.
4 CIL, 2.5 L	2006	T304 T328 22494 22885 22885 22886 T42024 T42023 38030 K050345 K040353 31119 31832 31336 33857	BANDA ARBOL DE LEVAS BANDA ARBOL DE LEVAS MANG. INF. MANG. INF. MANG. SUP. MANG. SUP. POLEA BANDA DE TIEMPO POLEA BANDA DE TIEMPO POLEA LOCA SERPENTIN SERPENTIN TAPON DE ACEITE TAPON DE GASOLINA TAPON DE RADIADOR TERMOSTATO	SIN LLAVE REGULAR (16 lbs) Sin Palanca 170°F SOCH (223 D x 27.0 mm) DOHC SOCH DOHC  INFERIOR MANO IZQUIERDA A.A. D.H. A.A.

**LEGACY**

4 CIL, 2.5 L	2007	T307	BANDA ARBOL DE LEVAS	SOCH
--------------	------	------	----------------------	------

**B9 TRIBECA**

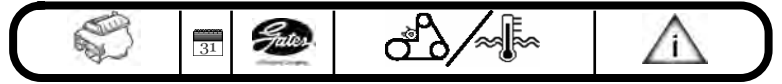

4 CIL, 2.5 L	2007	T328	BANDA ARBOL DE LEVAS	DOHC
		20473	MANG. INF.	DOHC
		22494	MANG. INF.	SOCH
		22886	MANG. SUP.	
		38030	POLEA LOCA	A.A.
		K040332	SERPENTIN	A.A.
		K050345	SERPENTIN	ALT. / D.H.
		31119	TAPON DE ACEITE	
		31838	TAPON DE GASOLINA	SIN LLAVE REGULAR
		31336	TAPON DE RADIADOR	(16 lbs) Sin Palanca
4 CIL, 2.5 L	2006	T328	BANDA ARBOL DE LEVAS	DOHC
		T307	BANDA ARBOL DE LEVAS	SOCH
		20473	MANG. INF.	DOHC
		22494	MANG. INF.	SOCH
		22886	MANG. SUP.	
		T42024	POLEA BANDA DE TIEMPO	
		T42023	POLEA BANDA DE TIEMPO	SUPERIOR MANO IZQUIERD/
		38030	POLEA LOCA	A.A.
		K050345	SERPENTIN	ALT. / D.H.
		K040332	SERPENTIN	A.A.
4 CIL, 2.5 L	2006	31119	TAPON DE ACEITE	
		31838	TAPON DE GASOLINA	SIN LLAVE REGULAR
		31336	TAPON DE RADIADOR	(16 lbs) Sin Palanca

33920	TERMOSTATO	180°F
-------	------------	-------

**GRAND VITARA**

4 CIL, 2.4 L	2010	18769	MANGUERA CALEFACCION	SALIDA		
		18769	MANGUERA CALEFACCION	ENTRADA		
		23583	MANGUERA INF.			
		21461	MANGUERA SUP.	RADIADOR A TANQUE		
		21551	MANGUERA SUP.	TANQUE A MOTOR		
		K060806	SERPENTIN			
		31412	TAPONES DE RADIADOR	16 LBS.		
		19545	MANGUERA CALEFACCION	SALIDA		
		18937	MANGUERA CALEFACCION	ENTRADA		
		23586	MANGUERA INF.			
V-6, 3.2 L	2010	23584	MANGUERA SUP.			
		K060854	SERPENTIN			
		31780	TAPON DE GASOLINA	CON LLAVE		
		31832	TAPON DE GASOLINA			
		38397	SENSOR			
		4 CIL, 2.4 L	2009	18769	MANGUERA CALEFACCION	SALIDA
				18769	MANGUERA CALEFACCION	ENTRADA
				23583	MANGUERA INF.	
				21551	MANGUERA SUP.	TANQUE A MOTOR
				21461	MANGUERA SUP.	RADIADOR A TANQUE
K060806	SERPENTIN					
31412	TAPONES DE RADIADOR			16 LBS.		
18937	MANGUERA CALEFACCION			ENTRADA		
19545	MANGUERA CALEFACCION			SALIDA		
23586	MANGUERA INF.					
V-6, 3.2 L	2009	23584	MANGUERA SUP.			
		K060854	SERPENTIN			
		31832	TAPON DE GASOLINA			
		31780	TAPON DE GASOLINA	CON LLAVE		
		38397	SENSOR			
		V-6, 2.7 L	2008	23158	MANGUERA INF.	
				23157	MANGUERA SUP.	
				K040430	SERPENTIN	A.A.
				K040372	SERPENTIN	ALTERNADOR
				31284	TAPON DE ACEITE	
31832	TAPON DE GASOLINA					
31780	TAPON DE GASOLINA			CON LLAVE		
31336	TAPONES DE RADIADOR			16 LIBRAS		
23158	MANGUERA INF.					
23157	MANGUERA SUP.					
V-6, 2.7 L	2007	K040430	SERPENTIN	D.H. C/AA		
		K040372	SERPENTIN	ALT.		
		31284	TAPON DE ACEITE			
		31780	TAPON DE GASOLINA	CON LLAVE		
		31832	TAPON DE GASOLINA			
		31336	TAPONES DE RADIADOR	16 LIBRAS		
		23158	MANGUERA INF.			
		23157	MANGUERA SUP.			
		K040372	SERPENTIN	ALT.		
		K040430	SERPENTIN	D.H. C/AA		
V-6, 2.7 L	2006	31284	TAPON DE ACEITE			
		31780	TAPON DE GASOLINA	CON LLAVE		
		31832	TAPON DE GASOLINA			
		31336	TAPONES DE RADIADOR	16 LIBRAS		
		23158	MANGUERA INF.			
		23157	MANGUERA SUP.			
		K040372	SERPENTIN	ALT.		
		K040430	SERPENTIN	D.H. C/AA		
		31284	TAPON DE ACEITE			
		31780	TAPON DE GASOLINA	CON LLAVE		
V-6, 2.5 L	2005	22048	MANG. INF.			
		20661	MANG. SUP.			
		K040365	SERPENTIN	ALT.		
		K040425	SERPENTIN	D.H., C/AA		
		K040400	SERPENTIN	D.H., S/AA		
		V-6, 2.5 L	2004	22048	MANG. INF.	
				20661	MANG. SUP.	
				K040365	SERPENTIN	ALT.
				K040400	SERPENTIN	D.H., S/AA
				K040425	SERPENTIN	D.H. C/AA

**OUTBACK**

4 CIL, 2.5 L	2007	T328	BANDA ARBOL DE LEVAS	DOHC
		T307	BANDA ARBOL DE LEVAS	SOCH
		20473	MANG. INF.	VIN 4TH DIGIT B
		22885	MANG. INF.	VIN 4TH DIGIT 6
		22886	MANG. SUP.	
		K050345	SERPENTIN	ALT. / D.H.
		K040353	SERPENTIN	A.A. VIN 4TH DIGIT
		K040332	SERPENTIN	A.A. VIN 4TH DIGIT 3
		31119	TAPON DE ACEITE	
		31838	TAPON DE GASOLINA	SIN LLAVE REGULAR
4 CIL, 2.5 L	2006	31336	TAPON DE RADIADOR	(16 lbs) Sin Palanca
		T307	BANDA ARBOL DE LEVAS	SOCH
		T328	BANDA ARBOL DE LEVAS	DOHC
		20473	MANG. INF.	VIN 4TH DIGIT B
		22885	MANG. INF.	VIN 4TH DIGIT 6
		22886	MANG. SUP.	
		38030	POLEA	A.A.
		T42024	POLEA BANDA DE TIEMPO	
		T42023	POLEA BANDA DE TIEMPO	SUPERIOR MANO IZQUIERD/
		K040332	SERPENTIN	A.A. VIN 4TH DIGIT 3
4 CIL, 2.5 L	2006	K040353	SERPENTIN	A.A. VIN 4TH DIGIT
		K050345	SERPENTIN	ALT. / D.H.
		31119	TAPON DE ACEITE	
		31838	TAPON DE GASOLINA	SIN LLAVE REGULAR
		31336	TAPON DE RADIADOR	(16 lbs) Sin Palanca

**SUZUKI**

**AERIO**

4 CIL, 2.3 L	2006	22557	MANG. INF.	
		22730	MANG. SUP.	
		38010	POLEA	
		K050660	SERPENTIN	
		31109	TAPON DE ACEITE	
		31612	TAPON DE GASOLINA	SIN LLAVE REGULAR
		31412	TAPON DE RADIADOR	(16 lbs) Sin Palanca
		38156	SENSOR MICRO-V	
		33920	TERMOSTATO	180°F
		4 CIL, 2.3 L	2005	22557
22730	MANG. SUP.			
38010	POLEA			
K050660	SERPENTIN			
31109	TAPON DE ACEITE			
31612	TAPON DE GASOLINA			SIN LLAVE REGULAR
31412	TAPON DE RADIADOR			(16 lbs) Sin Palanca
38156	SENSOR MICRO-V			











**KIZASHI**

4 CIL, 2.4 L	2010	K060705	SERPENTIN
--------------	------	---------	-----------

**SWIFT**

4 CIL, 1.6 L	2009	T338	BANDA ARBOL DE LEVAS	146 D X 24 MM
--------------	------	------	----------------------	---------------



									
V-8, 4.7 L	2004	36026 36119 T42031 K060882 31081 31839 31412 T43097 T41078 38173 33878	POLEA POLEA POLEA BANDA DE TIEMPO SERPENTIN TAPON DE ACEITE TAPON DE GASOLINA TAPON DE RADIADOR TENSOR ARBOL DE LEVAS TENSOR ARBOL DE LEVAS TENSOR MICRO-V TERMOSTATO	ALTERNADOR  SIN LLAVE REGULAR (16 lbs) Sin Palanca  180°F	4 CIL, 2.4 L	2009	19467 19466 23179 23178 37017P K070750 38453	MANGUERA CALEFACCION MANGUERA CALEFACCION MANGUERA INF. MANGUERA SUP. POLEA DECOPLADORA SERPENTIN TENSOR	ABAJO ARRIBA
V-8, 4.7 L	2003	T298 38001 36119 36026 T42031 K060882 31081 31840 31412 T43097 T41078 38173 33878	BANDA ARBOL DE LEVAS POLEA POLEA POLEA POLEA BANDA DE TIEMPO SERPENTIN TAPON DE ACEITE TAPON DE GASOLINA TAPON DE RADIADOR TENSOR ARBOL DE LEVAS TENSOR ARBOL DE LEVAS TENSOR MICRO-V TERMOSTATO	ALTERNADOR  CON LLAVE REGULAR (16 lbs) Sin Palanca  180°F	V-6, 3.5 L	2009	19468 19469 23154 23153 36173 37026P K070822 38410	MANGUERA CALEFACCION MANGUERA CALEFACCION MANGUERA INF. MANGUERA SUP. POLEA POLEA DECOPLADORA SERPENTIN TENSOR	ENTRADA SALIDA
V-6, 3.4 L	2002	K040343 T271 19130 K040420 TCK271 21534 21534 38031 31081 31832 31412 T41204 33868 K040413	A.A. BANDA ARBOL DE LEVAS CALEF. A TUBO-1 D.H. KIT DE DISTRIBUCION MANG. INF. MANG. SUP. POLEA TAPON DE ACEITE TAPON DE GASOLINA TAPON DE RADIADOR TENSOR ARBOL DE LEVAS TERMOSTATO VENT & ALT	{191 D x 36.0 mm} S/Calef. Auxiliar  CORTAR A MEDIDA CORTAR A MEDIDA A.A. SIN LLAVE REGULAR (16 lbs) Sin Palanca  180°F	V-6, 3.5 L	2008	19469 19468 23154 23153 K070825 31285 31780 31832 31412 19467 23179 23178 37017P K070750 31285 31832 31780 31412	MANGUERA CALEFACCION MANGUERA CALEFACCION MANGUERA INF. MANGUERA SUP. SERPENTIN TAPON DE ACEITE TAPON DE GASOLINA TAPON DE GASOLINA TAPON DE RADIADOR MANGUERA CALEFACCION MANGUERA INF. MANGUERA SUP. POLEA DECOPLADORA SERPENTIN TAPON DE ACEITE TAPON DE GASOLINA TAPON DE GASOLINA TAPON DE RADIADOR	CON LLAVE  180°F
4 CIL, 1.5 L	2010	K060740	SERPENTIN						
4 CIL, 1.5 L	2009	K060740	SERPENTIN						
4 CIL, 1.5 L	2008	K060740	SERPENTIN						
4 CIL, 1.5 L	2007	K060740	SERPENTIN						











**AVANZA**

4 CIL, 1.5 L	2010	K060740	SERPENTIN	
4 CIL, 1.5 L	2009	K060740	SERPENTIN	
4 CIL, 1.5 L	2008	K060740	SERPENTIN	
4 CIL, 1.5 L	2007	K060740	SERPENTIN	

**CAMRY**

4 CIL, 2.5 L	2011	23178 38018 36156 38025 K030471 K040488	MANGUERA SUP. POLEA POLEA POLEA SERPENTIN SERPENTIN	D.H. ALT. B.A. Y A.A. ENTRADA SALIDA	V-6, 3.5 L	2007	19468 19469 23154 23153 K070825 31285 31780 31832 31412	MANGUERA CALEFACCION MANGUERA CALEFACCION MANGUERA INF. MANGUERA SUP. SERPENTIN TAPON DE ACEITE TAPON DE GASOLINA TAPON DE GASOLINA TAPON DE RADIADOR	CON LLAVE
V-6, 3.5 L	2011	19468 19469 23154 23153 36173 37026P K070822 38410	MANGUERA CALEFACCION MANGUERA CALEFACCION MANGUERA INF. MANGUERA SUP. POLEA POLEA DECOPLADORA SERPENTIN TENSOR		4 CIL, 2.4 L	2006	22826 22827 K070763 31285 31839 31412 38216 33868	MANG. INF. MANG. SUP. SERPENTIN TAPON DE ACEITE TAPON DE GASOLINA TAPON DE RADIADOR TENSOR MICRO-V TERMOSTATO	SIN LLAVE REGULAR (16 lbs) Sin Palanca
4 CIL, 2.5 L	2010	23178 38018 36156 38025 K030471 K040488	MANGUERA SUP. POLEA POLEA POLEA SERPENTIN SERPENTIN	D.H. ALT. B.A. Y A.A. ENTRADA SALIDA	V-6, 3.0 L	2006	T257 22825 22309 T42030 K040347 K060408	BANDA ARBOL DE LEVAS MANG. INF. MANG. SUP. POLEA BANDA DE TIEMPO SERPENTIN SERPENTIN	180°F
V-6, 3.5 L	2010	19468 19469 23154 23153 36173 37026P K070822 38410	MANGUERA CALEFACCION MANGUERA CALEFACCION MANGUERA INF. MANGUERA SUP. POLEA POLEA DECOPLADORA SERPENTIN TENSOR	D.H. ALT. & A.A.	4 CIL, 2.4 L	2005	31279 31839 31336 T43098 33868 22826	TAPON DE ACEITE TAPON DE GASOLINA TAPON DE RADIADOR TENSOR ARBOL DE LEVAS TERMOSTATO MANG. INF.	SIN LLAVE REGULAR (16 lbs) Sin Palanca  180°F



    		    									
4 CIL, 2.4 L	2005	22827 K070763 31285 31839 31412 38216 33868	MANG. SUP. SERPENTIN TAPON DE ACEITE TAPON DE GASOLINA TAPON DE RADIADOR SENSOR MICRO-V TERMOSTATO	SIN LLAVE REGULAR (16 lbs) Sin Palanca	4 CIL, 2.2 L	2001	T43098 33868 28408 28408 BDH-5459 TCK199 T42025 31081 31780 31832 31411 T41067 33708 BDH-5459 TCK257 T42030 31780 31832 31336 T43096 T41075 33868	TENSOR ARBOL DE LEVAS TERMOSTATO TUBO-1 A VALV. REG. DE AIRE VALV. REG. DE AIRE A MULTIPL BOMBA DE DIR. HIDR. KIT DE DISTRIBUCION POLEA BANDA DE TIEMPO TAPON DE ACEITE TAPON DE GASOLINA TAPON DE GASOLINA TAPON DE RADIADOR TENSOR ARBOL DE LEVAS TERMOSTATO BOMBA DE DIR. HIDR. KIT DE DISTRIBUCION POLEA BANDA DE TIEMPO TAPON DE GASOLINA TAPON DE GASOLINA TAPON DE RADIADOR SENSOR ARBOL DE LEVAS TERMOSTATO	180°F	CON LLAVE REGULAR SIN LLAVE REGULAR (13 lbs) Sin palanca	
V-6, 3.0 L	2005	T257 22825 22309 T42030 K060408 K040347 31279 31839 31336 T43098 33868	BANDA ARBOL DE LEVAS MANG. INF. MANG. SUP. POLEA BANDA DE TIEMPO SERPENTIN SERPENTIN TAPON DE ACEITE TAPON DE GASOLINA TAPON DE RADIADOR TENSOR ARBOL DE LEVAS TERMOSTATO	SIN LLAVE REGULAR (16 lbs) Sin Palanca	V-6, 3.0 L	2001	BDH-5459 TCK257 T42030 31780 31832 31336 T43096 T41075 33868	BOMBA DE DIR. HIDR. KIT DE DISTRIBUCION POLEA BANDA DE TIEMPO TAPON DE GASOLINA TAPON DE GASOLINA TAPON DE RADIADOR SENSOR ARBOL DE LEVAS TERMOSTATO	180°F	CON LLAVE REGULAR SIN LLAVE REGULAR (16 lbs) Sin Palanca	
4 CIL, 2.4 L	2004	22826 22827 K070763 31285 31839 31412 38216 33868	MANG. INF. MANG. SUP. SERPENTIN TAPON DE ACEITE TAPON DE GASOLINA TAPON DE RADIADOR SENSOR MICRO-V TERMOSTATO	SIN LLAVE REGULAR (16 lbs) Sin Palanca							
V-6, 3.0 L	2004	T257 22825 22309 T42030 K060408 K040347 31279 31839 31336 T43098 33868	BANDA ARBOL DE LEVAS MANG. INF. MANG. SUP. POLEA BANDA DE TIEMPO SERPENTIN SERPENTIN TAPON DE ACEITE TAPON DE GASOLINA TAPON DE RADIADOR TENSOR ARBOL DE LEVAS TERMOSTATO	ALT. & A.A. D.H. SIN LLAVE REGULAR (16 lbs) Sin Palanca	4 CIL, 1.8 L	2010	37015P K060365 K060480 23529 23528 21461 37017P K070750 38453 37015P K060365 K060480 23529 23528 21461 37017P K070750 38453	POLEA DECOPLADORA SERPENTIN SERPENTIN MANGUERA INF. MANGUERA SUP. MANGUERA SUP. POLEA DECOPLADORA SERPENTIN TENSOR POLEA DECOPLADORA SERPENTIN SERPENTIN MANGUERA INF. MANGUERA SUP. MANGUERA SUP. POLEA DECOPLADORA SERPENTIN TENSOR	SIN A.A. CON A.A.	RADIADOR A T T A MOTOR	
4 CIL, 2.4 L	2003	22826 22827 K070763 31285 31839 31412 38216 33868	MANG. INF. MANG. SUP. SERPENTIN TAPON DE ACEITE TAPON DE GASOLINA TAPON DE RADIADOR SENSOR MICRO-V TERMOSTATO	SIN LLAVE REGULAR (16 lbs) Sin Palanca	4 CIL, 2.4 L	2009	37015P K060365 K060480 23529 23528 21461 37017P K070750 38453	POLEA DECOPLADORA SERPENTIN SERPENTIN MANGUERA INF. MANGUERA SUP. MANGUERA SUP. POLEA DECOPLADORA SERPENTIN TENSOR	SIN A.A. CON A.A.	RADIADOR A T T A MOTOR	
V-6, 3.0 L	2003	T257 22825 22309 T42030 K040347 K060408 31279 31839 31336 T43098 33868	BANDA ARBOL DE LEVAS MANG. INF. MANG. SUP. POLEA BANDA DE TIEMPO SERPENTIN SERPENTIN TAPON DE ACEITE TAPON DE GASOLINA TAPON DE RADIADOR TENSOR ARBOL DE LEVAS TERMOSTATO	D.H. ALT. & A.A. SIN LLAVE REGULAR (16 lbs) Sin Palanca	4 CIL, 1.8 L	2008	22758 22757 38018 K060605 K060739 31285 31839 31840 31411 38286 33868 22758 22757 38018 K060605 K060739	MANGUERA INF. MANGUERA SUP. POLEA SERPENTIN SERPENTIN TAPON DE ACEITE TAPON DE GASOLINA TAPON DE GASOLINA TAPON DE RADIADOR TENSOR MICRO-V TERMOSTATO MANGUERA INF. MANGUERA SUP. POLEA SERPENTIN SERPENTIN	SIN A.A. CON A.A.	CON LLAVE	
4 CIL, 2.2 L	2002	BDH-5459 31780 31832 31411	BOMBA DE DIR. HIDR. TAPON DE GASOLINA TAPON DE GASOLINA TAPON DE RADIADOR	CON LLAVE REGULAR SIN LLAVE REGULAR (13 lbs) Sin palanca	4 CIL, 1.8 L	2007	22758 22757 38018 K060605 K060739 31285 31839 31840 31411 38286 33868 22758 22757 38018 K060763 K060605 K060739	MANGUERA SUP. POLEA SERPENTIN SERPENTIN TAPON DE ACEITE TAPON DE GASOLINA TAPON DE GASOLINA TAPON DE RADIADOR TENSOR MICRO-V TERMOSTATO MANG. INF. MANG. SUP. POLEA SERPENTIN SERPENTIN SERPENTIN	SIN A.A. CON A.A.	CON LLAVE	
V-6, 3.0 L	2002	K060407 T257 BDH-5459 19092 K040347 TCK257 35B 1" 22306 22309 19093 T42030 31279 31780 31832 31336	BANDA ARBOL DE LEVAS BOMBA DE DIR. HIDR. CALEF. A TUBO-1 D.H. KIT DE DISTRIBUCION MANGUERA DE PASO MANGUERA INF. MANGUERA SUP. MULTIPLE A CALEF. POLEA BANDA DE TIEMPO TAPON DE ACEITE TAPON DE GASOLINA TAPON DE GASOLINA TAPON DE RADIADOR	SIN LLAVE REGULAR (16 lbs) Sin Palanca	4 CIL, 1.8 L	2006	22758 22757 38018 K060763 K060605 K060739 31285 31839 31840 31411 38286 33868 22758 22757 38018 K060763 K060605 K060739 31285 31839 31840 31411 38286	MANGUERA SUP. POLEA SERPENTIN SERPENTIN TAPON DE ACEITE TAPON DE GASOLINA TAPON DE GASOLINA TAPON DE RADIADOR TENSOR MICRO-V TERMOSTATO MANG. INF. MANG. SUP. POLEA SERPENTIN SERPENTIN SERPENTIN TAPON DE ACEITE TAPON DE GASOLINA TAPON DE GASOLINA TAPON DE RADIADOR TENSOR MICRO-V	180°F	S/A C/A SIN LLAVE REGULAR (13 lbs) Sin palanca	

## COROLLA

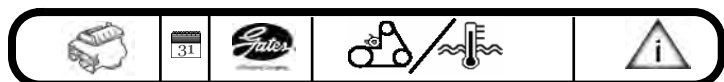

4 CIL, 1.8 L	2006	33868	TERMOSTATO	180°F
4 CIL, 1.8 L	2005	22758	MANGUERA INF.	
		22757	MANGUERA SUP.	
		38018	POLEA	
		K060763	SERPENTIN	C/AA
		K060605	SERPENTIN	
		K060739	SERPENTIN	
		31285	TAPON DE ACEITE	
		31839	TAPON DE GASOLINA	SIN LLAVE REGULAR
		31411	TAPON DE RADIADOR	(13 lbs) Sin palanca
		38286	SENSOR MICRO-V	
4 CIL, 1.8 L	2004	33868	TERMOSTATO	180°F
		22758	MANGUERA INF.	
		22757	MANGUERA SUP.	
		38018	POLEA	
		K060605	SERPENTIN	S/AA
		K060739	SERPENTIN	C/AA
		31081	TAPON DE ACEITE	
		31832	TAPON DE GASOLINA	SIN LLAVE REGULAR
		31411	TAPON DE RADIADOR	(13 lbs) Sin palanca
		38286	SENSOR MICRO-V	
4 CIL, 1.8 L	2003	33868	TERMOSTATO	180°F
		22758	MANGUERA INF.	
		22757	MANGUERA SUP.	
		38018	POLEA	
		K060739	SERPENTIN	C/AA
		K060605	SERPENTIN	S/AA
		31081	TAPON DE ACEITE	
		31832	TAPON DE GASOLINA	SIN LLAVE REGULAR
		31411	TAPON DE RADIADOR	(13 lbs) Sin palanca
		38286	SENSOR MICRO-V	
4 CIL, 1.8 L	2002	33868	TERMOSTATO	180°F
		19041	CALEF. A TUBO-1	
		18782	CALEF. A TUBO-2	
		22508	MANGUERA INF.	
		22335	MANGUERA SUP.	
		38018	POLEA DEL TENSOR	
		K060605	SERPENTIN	S/AA
		K060744	SERPENTIN	C/AA
		31081	TAPON DE ACEITE	
		31832	TAPON DE GASOLINA	SIN LLAVE REGULAR
		31411	TAPON DE RADIADOR	(13 lbs) Sin palanca
		38286	SENSOR MICRO-V	
		33868	TERMOSTATO	180°F
		28408	VALV. REG. DE AIRE A MULTIPL	

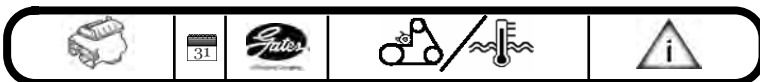

4 CIL, 2.7 L	2006	K070901	SERPENTIN	CON A.A.
		BDH-5587	BOMBA DE DIR. HIDR.	
		K070735	SERPENTIN	SIN A.A.
		K070901	SERPENTIN	CON A.A.

## HIGHLANDER

V-6, 3.5 L	2010	36173	POLEA	
		37026P	POLEA DECOPLADORA	
		K070610	SERPENTIN	
		38410	SENSOR	
V-6, 3.5 L	2009	23456	MANGUERA INF.	
		23455	MANGUERA SUP.	
		36173	POLEA	
		37026P	POLEA DECOPLADORA	
		K070610	SERPENTIN	
		31285	TAPON DE ACEITE	CON LLAVE
		31780	TAPON DE GASOLINA	
		31832	TAPON DE GASOLINA	
		31412	TAPONES DE RADIADOR	16 LBS.
		38410	SENSOR	
V-6, 3.5 L	2008	33983	TERMOSTATOS	180°
		23456	MANGUERA INF.	
		23455	MANGUERA SUP.	
		36173	POLEA	
		37026P	POLEA DECOPLADORA	
		K070610	SERPENTIN	
		31081	TAPON DE ACEITE	
		31832	TAPON DE GASOLINA	
		31780	TAPON DE GASOLINA	CON LLAVE
		38410	TENSOR	

## HILUX

4 CIL, 2.7L	2006	9470	BANDA V	S/AA
		K040430	SERPENTIN	D.H.
4 CIL, 2.7L	2005	9470	BANDA V	S/AA
		K040430	SERPENTIN	D.H.
4 CIL, 2.7L	2004	9470	BANDA V	S/AA
		K040430	SERPENTIN	D.H.
4 CIL, 2.7L	2003	9470	BANDA V	S/AA
		K040430	SERPENTIN	D.H.

## LAND CRUISER

V-8, 5.7 L	2010	23458	MANGUERA INF.	
		23457	MANGUERA SUP.	
		K080948	SERPENTIN	
		31412	TAPONES DE RADIADOR	16 LBS.
V-8, 5.7 L	2009	23458	MANGUERA INF.	
		23457	MANGUERA SUP.	
		K080948	SERPENTIN	
		31412	TAPONES DE RADIADOR	16 LBS.
V-8, 5.7 L	2008	23458	MANGUERA INF.	
		23457	MANGUERA SUP.	
		K080948	SERPENTIN	
		31412	TAPONES DE RADIADOR	16 LBS.
V-8, 4.7 L	2007	T298	BANDA ARBOL DE LEVAS	
		TCK298	KIT DE DISTRIBUCION	
		18201	MANGUERA DE PASO	
		22491	MANGUERA INF.	
		21660	MANGUERA SUP.	
		K060882	SERPENTIN	
		31081	TAPON DE ACEITE	
		31832	TAPON DE GASOLINA	
		31780	TAPON DE GASOLINA	CON LLAVE
		31336	TAPON DE RADIADOR	
		38173	TENSOR MICRO-V	
		33878	TERMOSTATO	180 ° F
V-8, 4.7 L	2006	T298	BANDA ARBOL DE LEVAS	(211 D x 34.0 mm)
		18201	MANG. DE PASO	
		22491	MANG. INF.	
		21660	MANG. SUP.	
		36119	POLEA	
		36026	POLEA	
		T42031	POLEA BANDA DE TIEMPO	

## FJ CRUISER

V-6, 4.0 L	2008	22845	MANGUERA INF.	
		22844	MANGUERA SUP.	
		K070834	SERPENTIN	
		31285	TAPON DE ACEITE	
		31832	TAPON DE GASOLINA	
		31780	TAPON DE GASOLINA	CON LLAVE
		31412	TAPON DE RADIADOR	16 LIBRAS
		38411	TENSOR MICRO-V	
V-6, 4.0 L	2007	22845	MANGUERA INF.	
		22844	MANGUERA SUP.	
		K070834	SERPENTIN	
		31285	TAPON DE ACEITE	
		31832	TAPON DE GASOLINA	
		31780	TAPON DE GASOLINA	CON LLAVE
		31412	TAPON DE RADIADOR	16 LIBRAS
		38411	TENSOR MICRO-V	

## HIACE

4 CIL, 2.7 L	2010	K070735	SERPENTIN	SIN A.A.
		K070901	SERPENTIN	CON A.A.
4 CIL, 2.7 L	2009	K070901	SERPENTIN	CON A.A.
		K070735	SERPENTIN	SIN A.A.
4 CIL, 2.7 L	2008	BDH-5587	BOMBA DE DIR. HIDR.	
		K070735	SERPENTIN	SIN A.A.
		K070901	SERPENTIN	CON A.A.
4 CIL, 2.7 L	2007	BDH-5587	BOMBA DE DIR. HIDR.	
		K070735	SERPENTIN	SIN A.A.

V-8, 4.7 L	2006	K060882	SERPENTIN	SIN LLAVE REGULAR (16 lbs) Sin Palanca	4 CIL, 1.8 L	38453	TENSOR	CON A.A. SIN A.A.	
		31081	TAPON DE ACEITE			22758	MANGUERA INF.		
		31832	TAPON DE GASOLINA			22757	MANGUERA SUP.		
		31336	TAPON DE RADIADOR			38018	POLEA		
		T41078	TENSOR ARBOL DE LEVAS			K060739	SERPENTIN		
		T43097	TENSOR ARBOL DE LEVAS			K060605	SERPENTIN		
		38173	TENSOR MICRO-V			31285	TAPON DE ACEITE		
		33878	TERMOSTATO			31839	TAPON DE GASOLINA		
		T298	BANDA ARBOL DE LEVAS			31840	TAPON DE GASOLINA		
		22491	MANG. INF.			31411	TAPON DE RADIADOR		
V-8, 4.7 L	2005	21660	MANG. SUP.	SIN LLAVE REGULAR (16 lbs) Sin Palanca	4 CIL, 1.8 L	38286	TENSOR MICRO-V	CON LLAVE  180°F	
		36119	POLEA			33868	TERMOSTATO		
		36026	POLEA			22758	MANGUERA INF.		
		T42031	POLEA BANDA DE TIEMPO			22757	MANGUERA SUP.		
		K060882	SERPENTIN			38018	POLEA		
		31081	TAPON DE ACEITE			K060605	SERPENTIN		
		31832	TAPON DE GASOLINA			K060739	SERPENTIN		
		31336	TAPON DE RADIADOR			31285	TAPON DE ACEITE		
		T41078	TENSOR ARBOL DE LEVAS			31839	TAPON DE GASOLINA		
		T43097	TENSOR ARBOL DE LEVAS			31840	TAPON DE GASOLINA		
V-8, 4.7 L	2004	38173	TENSOR MICRO-V	SIN LLAVE REGULAR (16 lbs) Sin Palanca	4 CIL, 1.8 L	31411	TAPON DE RADIADOR	CON LLAVE  180°F 2ZZGE 1ZZFE	
		33878	TERMOSTATO			38286	TENSOR MICRO-V		
		T298	BANDA ARBOL DE LEVAS			33868	TERMOSTATO		
		28466	ENTRADA			22759	MANG. INF.		
		18201	MANG. DE PASO			22758	MANG. INF.		
		22491	MANG. INF.			22757	MANG. SUP.		
		21660	MANG. SUP.			38018	POLEA		
		36026	POLEA			K060763	SERPENTIN		
		36119	POLEA			K060739	SERPENTIN		
		T42031	POLEA BANDA DE TIEMPO			31285	TAPON DE ACEITE		
V-8, 4.7 L	2003	28466	SALIDA	SIN LLAVE REGULAR (16 lbs) Sin Palanca	4 CIL, 1.8 L	31840	TAPON DE GASOLINA	CON LLAVE REGULAR (13 lbs) Sin palanca 1ZZFE MOTOR 1ZZFE MOTOR 2ZZGE	
		K060882	SERPENTIN			31411	TAPON DE RADIADOR		
		31081	TAPON DE ACEITE			38286	TENSOR MICRO-V		
		31832	TAPON DE GASOLINA			22759	MANG. INF.		
		31336	TAPON DE RADIADOR			22758	MANG. INF.		
		T43097	TENSOR ARBOL DE LEVAS			22757	MANG. SUP.		
		T41078	TENSOR ARBOL DE LEVAS			38018	POLEA		
		38173	TENSOR MICRO-V			K060739	SERPENTIN		
		33878	TERMOSTATO			K060763	SERPENTIN		
		T298	BANDA ARBOL DE LEVAS			31285	TAPON DE ACEITE		
4 CIL, 1.8 L	2010	37015P	POLEA DECOPLADORA	SIN LLAVE REGULAR (16 lbs) Sin Palanca	4 CIL, 1.8 L	31840	TAPON DE GASOLINA	CON LLAVE REGULAR (13 lbs) Sin palanca 1ZZFE MOTOR 1ZZFE MOTOR 2ZZGE	
		K060365	SERPENTIN			31411	TAPON DE RADIADOR		
		K060480	SERPENTIN			38286	TENSOR MICRO-V		
		23529	MANGUERA INF.			33868	TERMOSTATO		
		23528	MANGUERA SUP.			22759	MANGUERA INF.		
		21461	MANGUERA SUP.			22758	MANGUERA INF.		
		37017P	POLEA DECOPLADORA			22757	MANGUERA SUP.		
		K070750	SERPENTIN			38018	POLEA		
		38453	TENSOR			K060739	SERPENTIN		
		37015P	POLEA DECOPLADORA			K060763	SERPENTIN		
4 CIL, 2.4 L	2010	K060365	SERPENTIN	SIN LLAVE REGULAR (13 lbs) Sin palanca 1ZZFE 180°F	4 CIL, 2.5 L	2010	K060494	SERPENTIN	CON LLAVE  19 LBS.
		K060480	SERPENTIN			31285	TAPON DE ACEITE		
		23529	MANGUERA INF.			31780	TAPON DE GASOLINA		
		23528	MANGUERA SUP.			31832	TAPON DE GASOLINA		
		21461	MANGUERA SUP.			31832	TAPON DE GASOLINA		
		37017P	POLEA DECOPLADORA			31541	TAPONES DE RADIADOR		
		K070750	SERPENTIN						
		38453	TENSOR						
		37015P	POLEA DECOPLADORA						
		K060365	SERPENTIN						
4 CIL, 1.8 L	2009	K060480	SERPENTIN	SIN LLAVE REGULAR (16 lbs) Sin Palanca	4 CIL, 1.8 L	2009	K060494	SERPENTIN	CON LLAVE  19 LBS.
		23529	MANGUERA INF.			31285	TAPON DE ACEITE		
		23528	MANGUERA SUP.			31780	TAPON DE GASOLINA		
		21461	MANGUERA SUP.			31832	TAPON DE GASOLINA		
		37017P	POLEA DECOPLADORA			31541	TAPONES DE RADIADOR		
		K070750	SERPENTIN						
		38453	TENSOR						
		37015P	POLEA DECOPLADORA						
		K060365	SERPENTIN						
		K060480	SERPENTIN						
4 CIL, 2.4 L	2009	23529	MANGUERA INF.	SIN LLAVE REGULAR (16 lbs) Sin Palanca	4 CIL, 1.8 L	2009	K060494	SERPENTIN	CON LLAVE  19 LBS.
		23528	MANGUERA SUP.			31285	TAPON DE ACEITE		
		21461	MANGUERA SUP.			31780	TAPON DE GASOLINA		
		37017P	POLEA DECOPLADORA			31832	TAPON DE GASOLINA		
		K070750	SERPENTIN			31541	TAPONES DE RADIADOR		
		38453	TENSOR						
		37015P	POLEA DECOPLADORA						
		K060365	SERPENTIN						
		K060480	SERPENTIN						
		23529	MANGUERA INF.						

**MATRIX**

**RAV 4**

4 CIL, 2.5 L V-6, 3.5 L	2010	33983 23143 23301 36173 37026P K070610	TERMOSTATOS MANGUERA INF. MANGUERA SUP. POLEA POLEA DECOPLADORA SERPENTIN	180°
		31285 31832 31780 31541 38410 33868	TAPON DE ACEITE TAPON DE GASOLINA TAPON DE GASOLINA TAPONES DE RADIADOR TENSOR TERMOSTATOS	CON LLAVE 19 LBS. 180°
4 CIL, 2.5 L	2009	K060494	SERPENTIN	
		31285 31780 31832 31541 33983	TAPON DE ACEITE TAPON DE GASOLINA TAPON DE GASOLINA TAPONES DE RADIADOR TERMOSTATOS	CON LLAVE 19 LBS. 180°
V-6, 3.5 L	2009	23143 23301 36173 37026P K070610	MANGUERA INF. MANGUERA SUP. POLEA POLEA DECOPLADORA SERPENTIN	
		31285 31780 31832 31541 33868	TAPON DE ACEITE TAPON DE GASOLINA TAPON DE GASOLINA TAPONES DE RADIADOR TENSOR	CON LLAVE 19 LBS. 180°
4 CIL, 2.4 L	2008	33868 23142 23299 37017P K070750	TERMOSTATOS MANGUERA INF. MANGUERA SUP. POLEA DECOPLADORA SERPENTIN	180°
		31285 31832 31780 31541 33983	TAPON DE ACEITE TAPON DE GASOLINA TAPON DE GASOLINA TAPONES DE RADIADOR TERMOSTATOS	CON LLAVE 19 LBS. 180°
V-6, 3.5 L	2008	23143 23301 36173 37026P K070610	MANGUERA INF. MANGUERA SUP. POLEA POLEA DECOPLADORA SERPENTIN	
		31285 31832 31780 31541 38410 33868	TAPON DE ACEITE TAPON DE GASOLINA TAPON DE GASOLINA TAPONES DE RADIADOR TENSOR TERMOSTATOS	CON LLAVE 19 LBS. 180°
4 CIL, 2.4 L	2007	23142 23299 37017P K070750	MANGUERA INF. MANGUERA SUP. POLEA DECOPLADORA SERPENTIN	180°
		31285 31780 31832 31541 38216 33983	TAPON DE ACEITE TAPON DE GASOLINA TAPON DE GASOLINA TAPONES DE RADIADOR TENSOR MICRO-V TERMOSTATOS	CON LLAVE 19 LBS. 180°
4 CIL, 2.4 L	2006	22689 22688 K070750 K070763	MANG. INF. MANG. SUP. SERPENTIN SERPENTIN	180°
		31285 31832 31412 38216 33868	TAPON DE ACEITE TAPON DE GASOLINA TAPON DE RADIADOR TENSOR MICRO-V TERMOSTATO	SIN LLAVE REGULAR (16 lbs) Sin Palanca 180°F
V-6, 3.5 L 4 CIL, 2.4 L	2006 2005	K070610 22689 22688 K070763	SERPENTIN MANG. INF. MANG. SUP. SERPENTIN	
		31285 31832 31412	TAPON DE ACEITE TAPON DE GASOLINA TAPON DE RADIADOR	SIN LLAVE REGULAR (16 lbs) Sin Palanca

4 CIL, 2.4 L	2004	38216 33868 22688 22689 K070763	TENSOR MICRO-V TERMOSTATO MANGUERA INF. MANGUERA SUP. SERPENTIN	180°F ALTERNADOR Y VENTILADO
		31081 31832 31412 38216 33868	TAPON DE ACEITE TAPON DE GASOLINA TAPON DE RADIADOR TENSOR MICRO-V TERMOSTATO	SIN LLAVE REGULAR (16 lbs) Sin Palanca 180°F
4 CIL, 2.0 L	2003	22698 22688 K070763	MANG. INF. MANG. SUP. SERPENTIN	ALT. & VENT.
		31081 31832 31412 38216 33868	TAPON DE ACEITE TAPON DE GASOLINA TAPON DE RADIADOR TENSOR MICRO-V TERMOSTATO	SIN LLAVE REGULAR (16 lbs) Sin Palanca 180°F
4 CIL, 2.4 L	2003	22688 22689 K070763	MANGUERA INF. MANGUERA SUP. SERPENTIN	ALTERNADOR Y VENTILADO
		31081 31832 31412 33868	TAPON DE ACEITE TAPON DE GASOLINA TAPON DE RADIADOR TERMOSTATO	SIN LLAVE REGULAR (16 lbs) Sin Palanca 180°F

**RUSH**

4 CIL, 1.5 L	2010	K060739	SERPENTIN	CON A.A.
		K060721	SERPENTIN	SIN A.A.
4 CIL, 1.5 L	2009	K060739	SERPENTIN	CON A.A.
		K060721	SERPENTIN	SIN A.A.

**SEQUIOIA**

V-8, 5.7 L	2010	23310 23309 K080948	MANGUERA INF. MANGUERA SUP. SERPENTIN	
		31412	TAPONES DE RADIADOR	16 LBS.
V-8, 5.7 L	2009	23310 23309 K080948	MANGUERA INF. MANGUERA SUP. SERPENTIN	
		31412	TAPONES DE RADIADOR	16 LBS.
V-8, 4.7 L	2008	T298 T42031 36119 36026 K060882	BANDA ARBOL DE LEVAS POLEA POLEA POLEA SERPENTIN	
		31081 31839 31840 31411 T41078	TAPON DE ACEITE TAPON DE GASOLINA TAPON DE GASOLINA TAPON DE RADIADOR TENSOR ARBOL DE LEVAS	13 LIBRAS
		38173 33878	TENSOR MICRO-V TERMOSTATO	180 ° F
V-8, 4.7 L	2007	T298 T42031 36026 36119 K060882	BANDA ARBOL DE LEVAS POLEA POLEA POLEA SERPENTIN	
		31081 31839 31840 31411 T41078	TAPON DE ACEITE TAPON DE GASOLINA TAPON DE GASOLINA TAPON DE RADIADOR TENSOR ARBOL DE LEVAS	13 LIBRAS
		38173 33878	TENSOR MICRO-V TERMOSTATO	180 ° F

**SIENNA**

V-6, 3.5 L	2011	36173 37026P K070610	POLEA POLEA DECOPLADORA SERPENTIN	
		38410	TENSOR	
V-6, 3.5 L	2010	23284 23298	MANGUERA INF. MANGUERA SUP.	

V-6, 3.5 L	2010	36173 37026P K070822 31081 31780 31832 31412 38410 33983	POLEA POLEA DECOPLADORA SERPENTIN TAPON DE ACEITE TAPON DE GASOLINA TAPON DE GASOLINA TAPONES DE RADIADOR TENSOR TERMOSTATOS	CON LLAVE 16 LBS. 180°		T42030 K060408 K060374 K040347 31279 31839 31336 T43096 T41075 33868	POLEA BANDA DE TIEMPO SERPENTIN SERPENTIN SERPENTIN TAPON DE ACEITE TAPON DE GASOLINA TAPON DE RADIADOR TENSOR ARBOL DE LEVAS TENSOR ARBOL DE LEVAS TERMOSTATO	A.A. VENT & ALT. D.H. SIN LLAVE REGULAR (16 lbs) Sin Palanca 180°F	
V-6, 3.5 L	2009	23284 23298 36173 37026P K070822 31081 31832 31780 31412 38410 33983	MANGUERA INF. MANGUERA SUP. POLEA POLEA DECOPLADORA SERPENTIN TAPON DE ACEITE TAPON DE GASOLINA TAPON DE GASOLINA TAPONES DE RADIADOR TENSOR TERMOSTATOS	CON LLAVE 16 LBS. 180°	V-6, 3.0 L V-6, 3.0 L V-6, 3.0 L	2002 2001 2000	TCK257 T42030 T41075 T43096 TCK257 T42030 T41075 T43096 TCK257 T42030 T41075 T43096	KIT DE DISTRIBUCION POLEA BANDA DE TIEMPO TENSOR ARBOL DE LEVAS TENSOR ARBOL DE LEVAS KIT DE DISTRIBUCION POLEA BANDA DE TIEMPO TENSOR ARBOL DE LEVAS TENSOR ARBOL DE LEVAS KIT DE DISTRIBUCION POLEA BANDA DE TIEMPO TENSOR ARBOL DE LEVAS TENSOR ARBOL DE LEVAS	
V-6, 3.5 L	2008	23284 23298 36173 37026P K070825 31285 31832 31780 38410	MANGUERA INF. MANGUERA SUP. POLEA POLEA DECOPLADORA SERPENTIN TAPON DE ACEITE TAPON DE GASOLINA TAPON DE GASOLINA TENSOR	CON LLAVE 180°					
V-6, 3.5 L	2007	23284 23298 36173 37026P K070825 31285 31780 31832 38410	MANGUERA INF. MANGUERA SUP. POLEA POLEA DECOPLADORA SERPENTIN TAPON DE ACEITE TAPON DE GASOLINA TAPON DE GASOLINA TENSOR	CON LLAVE CON LLAVE	V-6, 3.3 L V-6, 3.3 L	2006 2005	T257 22825 22309 T42030 K060408 K040347 31279 31839 31336 T43098 33868 T257 22825 22309 T42030 K060408 K040347 31279 31839 31336 T43098 33868	BANDA ARBOL DE LEVAS MANG. INF. MANG. SUP. POLEA BANDA DE TIEMPO SERPENTIN SERPENTIN SERPENTIN TAPON DE ACEITE TAPON DE GASOLINA TAPON DE RADIADOR TENSOR ARBOL DE LEVAS TERMOSTATO BANDA ARBOL DE LEVAS MANG. INF. MANG. SUP. POLEA BANDA DE TIEMPO SERPENTIN SERPENTIN SERPENTIN TAPON DE ACEITE TAPON DE GASOLINA TAPON DE RADIADOR TENSOR ARBOL DE LEVAS TERMOSTATO	ALT. & A.A. D.H. SIN LLAVE REGULAR (16 lbs) Sin Palanca 180°F SIN LLAVE REGULAR (16 lbs) Sin Palanca 180°F
V-6, 3.3 L	2006	T257 22901 22902 T42030 K040347 K060408 31279 31839 31336 T43098 33868	BANDA ARBOL DE LEVAS MANG. INF. MANG. SUP. POLEA BANDA DE TIEMPO SERPENTIN SERPENTIN SERPENTIN TAPON DE ACEITE TAPON DE GASOLINA TAPON DE RADIADOR TENSOR ARBOL DE LEVAS TERMOSTATO	{211 D x 32.0 mm} D.H. ALT. & A.A. SIN LLAVE REGULAR (16 lbs) Sin Palanca 180°F					
V-6, 3.3 L	2005	T257 22901 22902 T42030 K060408 K040347 31279 31839 31336 T43098 33868	BANDA ARBOL DE LEVAS MANGUERA INF. MANGUERA SUP. POLEA BANDA DE TIEMPO SERPENTIN SERPENTIN TAPON DE ACEITE TAPON DE GASOLINA TAPON DE RADIADOR TENSOR ARBOL DE LEVAS TERMOSTATO	SIN LLAVE REGULAR (16 lbs) Sin Palanca 180°F	V-6, 4.0 L V-6, 4.0 L	2010 2009	22845 22844 36173 36174 K070834 38411 22845 22844 36174 36173 K070834 38411 22845 22844 K070834 31285 31840 31839 31412 34051 22845 22844 K070834 31285 31839 31840	MANGUERA INF. MANGUERA SUP. POLEA POLEA SERPENTIN TENSOR MANGUERA INF. MANGUERA SUP. POLEA POLEA SERPENTIN TENSOR MANGUERA INF. MANGUERA SUP. SERPENTIN TAPON DE ACEITE TAPON DE GASOLINA TAPON DE GASOLINA TAPON DE RADIADOR TERMOSTATO MANGUERA INF. MANGUERA SUP. SERPENTIN TAPON DE ACEITE TAPON DE GASOLINA TAPON DE GASOLINA	CON LLAVE 16 LIBRAS 180°F CON LLAVE 16 LIBRAS 180°F
V-6, 3.3 L	2004	T257 22901 22902 T42030 K060408 K040347 31279 31839 31336 T43098 33868	BANDA ARBOL DE LEVAS MANG. INF. MANG. SUP. POLEA BANDA DE TIEMPO SERPENTIN SERPENTIN TAPON DE ACEITE TAPON DE GASOLINA TAPON DE RADIADOR TENSOR ARBOL DE LEVAS TERMOSTATO	ALTERNADOR DIRECCIÓN HIDRÁULICA SIN LLAVE REGULAR (16 lbs) Sin Palanca 180°F	V-6, 4.0 L V-6, 4.0 L	2008 2007	22845 22844 K070834 31285 31840 31839 31412 34051 22845 22844 K070834 31285 31839 31840	MANGUERA INF. MANGUERA SUP. SERPENTIN TAPON DE ACEITE TAPON DE GASOLINA TAPON DE GASOLINA TAPON DE RADIADOR TERMOSTATO MANGUERA INF. MANGUERA SUP. SERPENTIN TAPON DE ACEITE TAPON DE GASOLINA TAPON DE GASOLINA	CON LLAVE 16 LIBRAS 180°F
V-6, 3.0 L	2003	TCK257 22306 22309	KIT DE DISTRIBUCION MANG. INF. MANG. SUP.	180°F	V-6, 4.0 L	2007	22845 22844 K070834 31285 31839 31840	MANGUERA INF. MANGUERA SUP. SERPENTIN TAPON DE ACEITE TAPON DE GASOLINA TAPON DE GASOLINA	CON LLAVE

**SOLARA**

**TACOMA**



V-6, 4.0 L	2007	31412	TAPON DE RADIADOR	16 LIBRAS
		34051	TERMOSTATO	180°F
V-6, 4.0 L	2006	22845	MANGUERA INF.	
		22844	MANGUERA SUP.	
		K070834	SERPENTIN	
		31285	TAPON DE ACEITE	
		31839	TAPON DE GASOLINA	
		31840	TAPON DE GASOLINA	CON LLAVE
		31412	TAPON DE RADIADOR	16 LIBRAS
		34051	TERMOSTATO	180°F

	2007	23146	MANGUERA INF.	
		22556	MANGUERA SUP.	DEPOSITO ANTICONGELANT
		23145	MANGUERA SUP.	RADIADOR AL DEPOSITO DE
		K040360	SERPENTIN	SIN A.A.
		K040465	SERPENTIN	CON A.A.
		31285	TAPON DE ACEITE	
		31780	TAPON DE GASOLINA	CON LLAVE
		31832	TAPON DE GASOLINA	
		31412	TAPON DE RADIADOR	
		33798	TERMOSTATO	180°F
	2006	23146	MANGUERA INF.	
		23145	MANGUERA SUP.	RADIADOR AL DEPOSITO DE
		22556	MANGUERA SUP.	DEPOSITO ANTICONGELANT
		K040360	SERPENTIN	SIN A.A.
		K040465	SERPENTIN	CON A.A.
		31285	TAPON DE ACEITE	
		31832	TAPON DE GASOLINA	
		31780	TAPON DE GASOLINA	CON LLAVE
		31412	TAPON DE RADIADOR	
		33798	TERMOSTATO	180°F
	2005	23146	MANGUERA INF.	
		22556	MANGUERA SUP.	DEPOSITO ANTICONGELANT
		23145	MANGUERA SUP.	RADIADOR AL DEPOSITO DE
		K040360	SERPENTIN	SIN A.A.
		K040465	SERPENTIN	CON A.A.
		31285	TAPON DE ACEITE	
		31780	TAPON DE GASOLINA	CON LLAVE
		31832	TAPON DE GASOLINA	
		31412	TAPON DE RADIADOR	
		33798	TERMOSTATO	180°F
	2004	K060696	SERPENTIN	ALTERNADOR Y VENTILADO
	2003	K060696	SERPENTIN	ALTERNADOR Y VENTILADO

**TUNDRA**

V-8, 5.7 L	2010	23310	MANGUERA INF.	
		23309	MANGUERA SUP.	
		K080948	SERPENTIN	
		31285	TAPON DE ACEITE	
		31832	TAPON DE GASOLINA	
		31780Y	TAPON DE GASOLINA	CON LLAVE FLEX FUEL
		31832Y	TAPON DE GASOLINA	FLEX FUEL
		31780	TAPON DE GASOLINA	CON LLAVE
		31412	TAPONES DE RADIADOR	16 LBS.
V-8, 5.7 L	2009	23310	MANGUERA INF.	
		23309	MANGUERA SUP.	
		K080948	SERPENTIN	
		31285	TAPON DE ACEITE	
		31780Y	TAPON DE GASOLINA	CON LLAVE FLEX FUEL
		31832	TAPON DE GASOLINA	
		31780	TAPON DE GASOLINA	CON LLAVE
		31832Y	TAPON DE GASOLINA	FLEX FUEL
		31412	TAPONES DE RADIADOR	16 LBS.
V-8, 4.7 L	2008	T298	BANDA ARBOL DE LEVAS	
		TCK298	KIT DE DISTRIBUCION	
		T42031	POLEA	
		36026	POLEA	
		K060878	SERPENTIN	
		31081	TAPON DE ACEITE	
		31832	TAPON DE GASOLINA	CON LLAVE
		31780	TAPON DE GASOLINA	16 LIBRAS
		31412	TAPON DE RADIADOR	
		T41078	TENSOR ARBOL DE LEVAS	
		38173	TENSOR MICRO-V	
V-8, 4.7 L	2007	T298	BANDA ARBOL DE LEVAS	
		TCK298	KIT DE DISTRIBUCION	
		T42031	POLEA	
		36026	POLEA	
		K060878	SERPENTIN	
		31081	TAPON DE ACEITE	
		31832	TAPON DE GASOLINA	CON LLAVE
		31780	TAPON DE GASOLINA	16 LIBRAS
		31412	TAPON DE RADIADOR	
		T41078	TENSOR ARBOL DE LEVAS	
		38173	TENSOR MICRO-V	











**VOLKSWAGEN**











**BEEBLE**





	2010	36105	POLEA	
		K050368	SERPENTIN	A.A.
		DK050610	SERPENTIN	ALT. B.A. Y D.H.
		31529	TAPONES DE RADIADOR	22 LBS.
		38314	TENSOR	A.A.
		38315	TENSOR	ALT. B.A. Y D.H.
	2009	36105	POLEA	
		K050368	SERPENTIN	A.A.
		DK050610	SERPENTIN	ALT. B.A. Y D.H.
		31529	TAPONES DE RADIADOR	22 LBS.
		38314	TENSOR	A.A.
		38315	TENSOR	ALT. B.A. Y D.H.
	2008	22615	MANGUERA INF.	
		22407	MANGUERA SUP.	
		38018	POLEA	
		6DPK1200	SERPENTIN	
		31100	TAPON DE ACEITE	
		31613	TAPON DE GASOLINA	
		31783	TAPON DE GASOLINA	CON LLAVE
		31529	TAPON DE RADIADOR	
		38148	TENSOR MICRO-V	
		33923	TERMOSTATO	190°F
	2008	DK050610	SERPENTIN	ALT. & D.H.
		K050368	SERPENTIN	CON A.A.
		31100	TAPON DE ACEITE	
		31708	TAPON DE GASOLINA	CON LLAVE
		31613	TAPON DE GASOLINA	
		31529	TAPON DE RADIADOR	
	2007	22615	MANGUERA INF.	
		22407	MANGUERA SUP.	
		38018	POLEA	
		6DPK1200	SERPENTIN	
		31100	TAPON DE ACEITE	
		31613	TAPON DE GASOLINA	
		31783	TAPON DE GASOLINA	CON LLAVE
		31529	TAPON DE RADIADOR	





**YARIS**

4 CIL, 1.5 L	2010	23146	MANGUERA INF.	
		22556	MANGUERA SUP.	TANQUE A MOTOR
		23145	MANGUERA SUP.	RADIADOR A TANQUE
		K040360	SERPENTIN	SIN A.A.
		K040465	SERPENTIN	CON A.A.
4 CIL, 1.5 L	2009	23146	MANGUERA INF.	
		22556	MANGUERA SUP.	TANQUE A MOTOR
		23145	MANGUERA SUP.	RADIADOR A TANQUE
		K040465	SERPENTIN	CON A.A.
		K040360	SERPENTIN	SIN A.A.
4 CIL, 1.5 L	2008	23146	MANGUERA INF.	
		23145	MANGUERA SUP.	RADIADOR AL DEPOSITO DE
		22556	MANGUERA SUP.	DEPOSITO ANTICONGELANT
		K040360	SERPENTIN	SIN A.A.
		K040465	SERPENTIN	CON A.A.
		31285	TAPON DE ACEITE	
		31832	TAPON DE GASOLINA	
		31780	TAPON DE GASOLINA	CON LLAVE
		31412	TAPON DE RADIADOR	
		33798	TERMOSTATO	180°F

    				    						
4 CIL, 2.0 L	2007	38148 33923	TENSOR MICRO-V TERMOSTATO	190°F				31529	TAPON DE RADIADOR	(22 lbs) Sin Palanca
5 CIL, 2.5 L	2007	K050368 DK050610	SERPENTIN SERPENTIN	CON A.A. ALT. & D.H.	4 CIL, 2.0 L			38148 33923	TENSOR MICRO-V TERMOSTATO	195°F
4 CIL, 2.0 L	2006	31100 31613 31708 31529 T296 22615 22407 38018 6DPK1200 K060441 31100 31613 31529 38148 33923	TAPON DE ACEITE TAPON DE GASOLINA TAPON DE GASOLINA TAPON DE RADIADOR BANDA ARBOL DE LEVAS MANG. INF. MANG. SUP. POLEA SERPENTIN SERPENTIN TAPON DE ACEITE TAPON DE GASOLINA TAPON DE RADIADOR TENSOR MICRO-V TERMOSTATO	CON LLAVE C/AA S/AA SIN LLAVE REGULAR (22 lbs) Sin Palanca	4 CIL, 1.8 L			TCK296 22615 22407 38018 37013P 6DPK1200 31100 31833 31529 T43010 38148 33923	KIT DE DISTRIBUCION MANGUERA INF. MANGUERA SUP. POLEA POLEA DECOPLADORA SERPENTIN TAPON DE ACEITE TAPON DE GASOLINA TAPON DE RADIADOR TENSOR ARBOL DE LEVAS TENSOR MICRO-V TERMOSTATO	ALTERNADOR C/AA SIN LLAVE REGULAR (22 lbs) Sin Palanca 195°F
5 CIL, 2.5 L	2006	DK050610 K050368 31100 31613 31708 31529	SERPENTIN SERPENTIN TAPON DE ACEITE TAPON DE GASOLINA TAPON DE GASOLINA TAPON DE RADIADOR	195°F ALT. & D.H. CON A.A.				T306 38018 37013P 6DPK1200 31100 31781 31833 31529 38148 33923	BANDA ARBOL DE LEVAS POLEA POLEA DECOPLADORA SERPENTIN TAPON DE ACEITE TAPON DE GASOLINA TAPON DE GASOLINA TAPON DE RADIADOR TENSOR MICRO-V TERMOSTATO	CON LLAVE REGULAR SIN LLAVE REGULAR (22 lbs) Sin Palanca 195°F
4 CIL, 1.8 L	2005	T306 22615 38018 6DPK1200 31100 31613 31529 38148 33923	BANDA ARBOL DE LEVAS MANGUERA INF. POLEA SERPENTIN TAPON DE ACEITE TAPON DE GASOLINA TAPON DE RADIADOR TENSOR MICRO-V TERMOSTATO	CON LLAVE SIN LLAVE REGULAR (22 lbs) Sin Palanca	4 CIL, 2.0 L			T296 TCK296 19705 19706 19077 19068 22615 22407 38018 37013P 6DPK1200 31100 31833 31781 31529 T43010 38148 33923	BANDA ARBOL DE LEVAS KIT DE DISTRIBUCION MANG. CALEF. A TUBO-1 MANG. CALEF. A TUBO-1 A CAL MANG. CALEF. A ENF. DE ACEIT MANG. DE CALEF. TUBO-1 A T1 MANG. INF. MANG. SUP. POLEA POLEA DECOPLADORA SERPENTIN TAPON DE ACEITE TAPON DE GASOLINA TAPON DE GASOLINA TAPON DE RADIADOR TENSOR ARBOL DE LEVAS TENSOR MICRO-V TERMOSTATO	S/AA, C/DH C/AA, C/DH 195°F
4 CIL, 2.0 L	2005	T296 TCK296 22615 22407 38018 6DPK1200 K060441 31100 31613 31529 T43010 38148 33923	BANDA ARBOL DE LEVAS KIT DE DISTRIBUCION MANGUERA INF. MANGUERA SUP. POLEA SERPENTIN SERPENTIN TAPON DE ACEITE TAPON DE GASOLINA TAPON DE RADIADOR TENSOR ARBOL DE LEVAS TENSOR MICRO-V TERMOSTATO	195°F	4 CIL, 1.8 L			T306 22615 38018 37013P 21532 31100 31781 31833 31529 38148 33923 19788 T296 TCK296 19705 19068 19077 19706 22408 22407 38018 37013P 6DPK1200 31100 31833 31781 31529 T43010 38148 33923	BANDA ARBOL DE LEVAS KIT DE DISTRIBUCION MANGUERA INF. MANGUERA SUP. POLEA SERPENTIN SERPENTIN TAPON DE ACEITE TAPON DE GASOLINA TAPON DE RADIADOR TENSOR ARBOL DE LEVAS TENSOR MICRO-V TERMOSTATO BANDA ARBOL DE LEVAS MANGUERA INF. POLEA POLEA DECOPLADORA SUP. - RADIADOR A T1 TAPON DE ACEITE TAPON DE GASOLINA TAPON DE GASOLINA TAPON DE RADIADOR TENSOR MICRO-V TENSOR MICRO-V TERMOSTATO TUBO-1 A CALEF. BANDA ARBOL DE LEVAS KIT DE DISTRIBUCION MANGUERA DE CALEF. MANGUERA DE CALEF. MANGUERA DE CALEF. MANGUERA DE CALEF. MANGUERA INF. MANGUERA SUP. POLEA POLEA DECOPLADORA SERPENTIN TAPON DE ACEITE TAPON DE GASOLINA TAPON DE GASOLINA TAPON DE RADIADOR TENSOR ARBOL DE LEVAS TENSOR MICRO-V TERMOSTATO	SIN LLAVE REGULAR CON LLAVE REGULAR (22 lbs) Sin Palanca 195°F SIN LLAVE REGULAR CON LLAVE REGULAR (22 lbs) Sin Palanca 195°F C/AA & S/AA, C/DH C/AA, & S/AA, C/DH C/AA & S/AA, C/DH C/AA & S/AA, C/DH C/AA, S/AA C/DH C/AA, S/AA C/DH
4 CIL, 1.8 L	2004	T296 TCK296 22615 22407 38018 6DPK1200 31100 31613 31529 38148 33923	BANDA ARBOL DE LEVAS MANGUERA INF. POLEA SERPENTIN TAPON DE ACEITE TAPON DE GASOLINA TAPON DE RADIADOR TENSOR MICRO-V TERMOSTATO	CON LLAVE SIN LLAVE REGULAR (22 lbs) Sin Palanca	4 CIL, 2.0 L			T296 TCK296 19705 19068 19077 19706 22408 22407 38018 37013P 6DPK1200 31100 31833 31781 31529 T43010 38148 33923	BANDA ARBOL DE LEVAS KIT DE DISTRIBUCION MANGUERA INF. MANGUERA SUP. POLEA SERPENTIN SERPENTIN TAPON DE ACEITE TAPON DE GASOLINA TAPON DE RADIADOR TENSOR ARBOL DE LEVAS TENSOR MICRO-V TERMOSTATO	195°F
4 CIL, 2.0 L	2004	T296 TCK296 22615 22407 38018 6DPK1200 31100 31613 31529 T43010 38148 33923	BANDA ARBOL DE LEVAS KIT DE DISTRIBUCION MANGUERA INF. MANGUERA SUP. POLEA SERPENTIN SERPENTIN TAPON DE ACEITE TAPON DE GASOLINA TAPON DE RADIADOR TENSOR ARBOL DE LEVAS TENSOR MICRO-V TERMOSTATO	195°F	4 CIL, 2.0 L			T296 TCK296 19705 19068 19077 19706 22408 22407 38018 37013P 6DPK1200 31100 31833 31781 31529 T43010 38148 33923	BANDA ARBOL DE LEVAS KIT DE DISTRIBUCION MANGUERA INF. MANGUERA SUP. POLEA SERPENTIN SERPENTIN TAPON DE ACEITE TAPON DE GASOLINA TAPON DE RADIADOR TENSOR ARBOL DE LEVAS TENSOR MICRO-V TERMOSTATO	195°F
4 CIL, 1.8 L	2003	T306 22615 38018 37013P 6DPK1200 31100 31833	BANDA ARBOL DE LEVAS MANGUERA INF. POLEA POLEA DECOPLADORA SERPENTIN TAPON DE ACEITE TAPON DE GASOLINA	MOTOR DE INTEFASE SIN LLAVE REGULAR	4 CIL, 1.8 L			T306 22615 38018 37013P 6DPK1200 31100 31833 31781 31529 T43010 38148 33923 T306 22615	BANDA ARBOL DE LEVAS MANGUERA INF. POLEA POLEA DECOPLADORA SERPENTIN TAPON DE ACEITE TAPON DE GASOLINA TAPON DE RADIADOR TENSOR ARBOL DE LEVAS TENSOR MICRO-V TERMOSTATO BANDA ARBOL DE LEVAS MANGUERA INF.	CON LLAVE REGULAR CON LLAVE REGULAR (22 lbs) Sin Palanca 195°F

    		    							
4 CIL, 1.8 L	2000	38018 37013P 21532 31100 31833 31781 31529 38148 33923 19788	POLEA POLEA DECOPLADORA SUP. - RADIADOR A T1 TAPON DE ACEITE TAPON DE GASOLINA TAPON DE GASOLINA TAPON DE RADIADOR SENSOR MICRO-V TERMOSTATO TUBO-1 A CALEF.		33923	TERMOSTATO	195°F		
<b>BORA</b>									
4 CIL, 2.0 L	2000	K060385 K060454 T262 T296 6294 GS 92025 TCK296 19705 19068 19077 19706 22408 22407 38018 37013P 6DPK1200 31100 31781 31833 31529 T43010 38148 33923	ALT. ALT. BANDA ARBOL DE LEVAS BANDA ARBOL DE LEVAS D.H. EDH KIT DE DISTRIBUCION MANGUERA DE CALEF. MANGUERA DE CALEF. MANGUERA DE CALEF. MANGUERA DE CALEF. MANGUERA INF. MANGUERA SUP. POLEA POLEA DECOPLADORA SERPENTIN TAPON DE ACEITE TAPON DE GASOLINA TAPON DE GASOLINA TAPON DE RADIADOR TENSOR ARBOL DE LEVAS SENSOR MICRO-V TERMOSTATO	S/AA, C/DH C/AA, C/DH C/AA, C/DH C/AA & S/AA, C/DH PRESION C/AA & S/AA, C/DH C/AA, & S/AA, C/DH C/AA & S/AA, C/DH C/AA & S/AA, C/DH C/AA, S/AA C/DH C/AA, S/AA C/DH	4 CIL, 2.0 L DIESEL 4 CIL, 2.0 L DIESEL 5 CIL, 2.5 L	2010 2009 2009	T41229 K060420 T41229 K060420 23074 23075 36105 36106 K050418 K050365 31100 31613 31708 31529 38315 38314 23074 23075 K050365 K050418 31100 31613 31708 31529 36106 36105 38314 38315	POLEA DE DISTRIBUCION SERPENTIN POLEA DE DISTRIBUCION SERPENTIN MANGUERA INF. MANGUERA SUP. POLEA POLEA SERPENTIN SERPENTIN TAPON DE ACEITE TAPON DE GASOLINA TAPON DE GASOLINA TAPONES DE RADIADOR TENSOR TENSOR MANGUERA INF. MANGUERA SUP. SERPENTIN SERPENTIN TAPON DE ACEITE TAPON DE GASOLINA TAPON DE GASOLINA TAPON DE RADIADOR POLEA POLEA TENSOR TENSOR BANDA ARBOL DE LEVAS POLEA POLEA SERPENTIN TAPON DE GASOLINA TAPON DE GASOLINA TAPON DE RADIADOR TENSOR ARBOL DE LEVAS TERMOSTATO MANGUERA INF. MANGUERA SUP. SERPENTIN SERPENTIN TAPON DE ACEITE TAPON DE GASOLINA TAPON DE GASOLINA TAPON DE RADIADOR POLEA POLEA TENSOR TENSOR MANGUERA INF. MANGUERA SUP. SERPENTIN SERPENTIN TAPON DE ACEITE TAPON DE GASOLINA TAPON DE GASOLINA TAPON DE RADIADOR POLEA POLEA TENSOR TENSOR MANGUERA INF. MANGUERA SUP. SERPENTIN SERPENTIN TAPON DE ACEITE TAPON DE GASOLINA TAPON DE GASOLINA TAPON DE RADIADOR POLEA POLEA	ALT. B.A. Y D.H. A.A. ALT. B.A. Y D.H. A.A. CON LLAVE 22 LBS. ALT. B.A. Y D.H. A.A. A.A. ALTERNADOR Y B.A. CON LLAVE A.A. ALT. B.A. Y D.H. A.A. ALT. B.A. Y D.H. CON LLAVE 190°F ALTERNADOR Y B.A. A.A. CON LLAVE ALT. B.A. Y D.H. A.A. ALT. B.A. Y D.H. A.A. A.A. ALTERNADOR Y B.A. A.A. CON LLAVE ALT. B.A. Y D.H. A.A. ALT. B.A. Y D.H. A.A.
4 CIL, 2.0 L	1999	T306 22615 38018 37013P 21532 31100 31781 31833 31529 38148 33923 19788	BANDA ARBOL DE LEVAS MANGUERA INF. POLEA POLEA DECOPLADORA SUP. - RADIADOR A T1 TAPON DE ACEITE TAPON DE GASOLINA TAPON DE GASOLINA TAPON DE RADIADOR TENSOR MICRO-V TERMOSTATO TUBO-1 A CALEF.	CON LLAVE REGULAR SIN LLAVE REGULAR (22 lbs) Sin Palanca 195°F	4 CIL, 1.9 L DIESEL	2007	T333 T41229 38018 K060415 31781 31833 31529 T43091 33209 23074 23075 K050418 K050365 31100 31613 31708 31529	POLEA POLEA SERPENTIN TAPON DE GASOLINA TAPON DE GASOLINA TAPON DE RADIADOR TENSOR ARBOL DE LEVAS TERMOSTATO MANGUERA INF. MANGUERA SUP. SERPENTIN SERPENTIN TAPON DE ACEITE TAPON DE GASOLINA TAPON DE GASOLINA TAPON DE RADIADOR	CON LLAVE 190°F
4 CIL, 2.0 L	1999	T296 92025 TCK296 19705 19077 19068 19706 22408 22407 38018 37013P 31100 31781 31833 31529 T43010 38148 33923	BANDA ARBOL DE LEVAS EDH KIT DE DISTRIBUCION MANGUERA DE CALEF. MANGUERA DE CALEF. MANGUERA DE CALEF. MANGUERA DE CALEF. MANGUERA INF. MANGUERA SUP. POLEA POLEA DECOPLADORA TAPON DE ACEITE TAPON DE GASOLINA TAPON DE GASOLINA TAPON DE RADIADOR TENSOR ARBOL DE LEVAS SENSOR MICRO-V TERMOSTATO	PRESION C/AA & S/AA, C/DH C/AA & S/AA, C/DH C/AA, & S/AA, C/DH C/AA & S/AA, C/DH C/AA, S/AA C/DH C/AA, S/AA C/DH	5 CIL, 2.5 L 5 CIL, 2.5 L	2007 2006	36105 36106 38315 38314 23074 23075 K050365 K050418 31100 31613 31708 31529 36105 36106 38315 38314 23074 23075 K050418 K050365 31100 31613 31708 31529	POLEA POLEA TENSOR TENSOR MANGUERA INF. MANGUERA SUP. SERPENTIN SERPENTIN TAPON DE ACEITE TAPON DE GASOLINA TAPON DE GASOLINA TAPON DE RADIADOR POLEA POLEA TENSOR TENSOR MANGUERA INF. MANGUERA SUP. SERPENTIN SERPENTIN TAPON DE ACEITE TAPON DE GASOLINA TAPON DE GASOLINA TAPON DE RADIADOR POLEA POLEA	ALT. B.A. Y D.H. A.A. ALT. B.A. Y D.H. A.A. A.A. ALTERNADOR Y B.A. A.A. CON LLAVE ALT. B.A. Y D.H. A.A. ALT. B.A. Y D.H. A.A.
4 CIL, 2.0 L	1998	92025 TCK296 22408 22407 37013P 38018 6DPK1200 31100 31833 31529 T43010 38148	EDH KIT DE DISTRIBUCION MANGUERA INF. MANGUERA SUP. POLEA DECOPLADORA POLEA DEL TENSOR SERPENTIN TAPON DE ACEITE TAPON DE GASOLINA TAPON DE RADIADOR TENSOR ARBOL DE LEVAS SENSOR MICRO-V	PRESION SIN LLAVE REGULAR (22 lbs) Sin Palanca 195°F	5 CIL, 2.5 L 5 CIL, 2.5 L	2005 2005	23074 23075 K050418 K050365 31100 31613 31708 31529 36106 36105	MANGUERA INF. MANGUERA SUP. SERPENTIN SERPENTIN TAPON DE ACEITE TAPON DE GASOLINA TAPON DE GASOLINA TAPON DE RADIADOR POLEA POLEA	ALTERNADOR Y B.A. A.A. CON LLAVE A.A. ALT. B.A. Y D.H.

				
5 CIL. 2.5 L	2005	38314 38315	TENSOR TENSOR	A.A. ALT. B.A. Y D.H.

				
31833 31328 T41079 38147 33209 19708			TAPON DE GASOLINA TAPON DE RADIADOR TENSOR ARBOL DE LEVAS TENSOR MICRO-V TERMOSTATO TUBO-1 A CALEF.	SIN LLAVE REGULAR (20 lbs) Sin palanca    195°F

**BORA SPORTWAGEN**

5 CIL. 2.5 L	2009	23074 23075 36105 36106 K050418 K050365 31100 31613 31708 31529 38314 38315	MANGUERA INF. MANGUERA SUP. POLEA POLEA SERPENTIN SERPENTIN TAPON DE ACEITE TAPON DE GASOLINA TAPON DE GASOLINA TAPONES DE RADIADOR TENSOR TENSOR	ALT. B.A. Y D.H. A.A. ALT. B.A. Y D.H. A.A.  CON LLAVE 22 LBS. A.A. ALT. B.A. Y D.H.	4 CIL. 2.0 L	
5 CIL. 2.5 L	2008	K050418 K050365	SERPENTIN SERPENTIN	ALTERNADOR Y B.A. A.A.		
5 CIL. 2.5 L	2008	23074 23075 36105 36106 31100 31613 31708 31529 38314 38315	MANGUERA INF. MANGUERA SUP. POLEA POLEA TAPON DE ACEITE TAPON DE GASOLINA TAPON DE GASOLINA TAPONES DE RADIADOR TENSOR TENSOR	ALT. B.A. Y D.H. A.A.  CON LLAVE 22 LBS. A.A. ALT. B.A. Y D.H.	4 CIL. 2.0 L	

**CABRIO**

4 CIL. 2.0 L	2002	K060455 K060385 7295 T262 19706 TCK262 22278 22277 38087 31100 31833 31328 T41079 38147 33923 19708	ALT & A.A. BA Y ALT BA Y D.H. BANDA ARBOL DE LEVAS CALEF. A TERMOSTATO KIT DE DISTRIBUCION MANGUERA INF. MANGUERA SUP. POLEA TAPON DE ACEITE TAPON DE GASOLINA TAPON DE RADIADOR TENSOR ARBOL DE LEVAS TENSOR MICRO-V TERMOSTATO TUBO-1 A CALEF.	S/AA       ALT. Y A.A. SIN LLAVE REGULAR (20 lbs) Sin palanca  195°F	4 CIL. 2.0 L	
4 CIL. 2.0 L	2001	K060455 K060385 7295 T262 19706 TCK262 22278 22277 38087 31100 31833 31328 T41079 38147 33209 19708	ALT & A.A. BA Y ALT BA Y D.H. BANDA ARBOL DE LEVAS CALEF. A TERMOSTATO KIT DE DISTRIBUCION MANGUERA INF. MANGUERA SUP. POLEA TAPON DE ACEITE TAPON DE GASOLINA TAPON DE RADIADOR TENSOR ARBOL DE LEVAS TENSOR MICRO-V TERMOSTATO TUBO-1 A CALEF.	S/AA       ALT. Y A.A. SIN LLAVE REGULAR (20 lbs) Sin palanca  195°F	4 CIL. 2.0 L	
4 CIL. 2.0 L	2000	K060455 K060385 7295 T262 6294 GS TCK262 19706 22278 CH-228182 22277 38087 31100	ALT & A.A. ALT. BA Y D.H. BANDA ARBOL DE LEVAS D.H. KIT DE DISTRIBUCION MANGUERA DE CALEF. MANGUERA INF. MANGUERA INF. MANGUERA SUP. POLEA TAPON DE ACEITE	S/AA, C/DH C/AA, C/DH C/AA & S/AA, C/DH C/AA C/AA ALT. Y A.A.	4 CIL. 2.0 L	

**COMBI**

4 CIL. 1.8 L	2001	K060365 T260 CH-220593 CH-227182 CH-227181	ALT. BANDA ARBOL DE LEVAS MANGUERA DE PASO MANGUERA INF. MANGUERA SUP.	C/RAD C/RAD C/RAD C/RAD C/RAD	4 CIL. 1.8 L	
4 CIL. 1.8 L	2000	K060365 T260 CH-220593 CH-227182 CH-227181 31100	ALT. BANDA ARBOL DE LEVAS MANGUERA DE PASO MANGUERA INF. MANGUERA SUP. TAPON DE ACEITE	C/RAD C/RAD C/RAD C/RAD C/RAD	4 CIL. 1.8 L	
4 CIL. 1.8 L	1999	K060365 T260 CH-220593 CH-227182 CH-227181 31100	ALT. BANDA ARBOL DE LEVAS MANGUERA DE PASO MANGUERA INF. MANGUERA SUP. TAPON DE ACEITE	C/RAD C/RAD C/RAD C/RAD C/RAD	4 CIL. 1.8 L	
4 CIL. 1.8 L	1998	K060365 T260 CH-220593 CH-227182 CH-227181 31100	ALT. BANDA ARBOL DE LEVAS MANGUERA DE PASO MANGUERA INF. MANGUERA SUP. TAPON DE ACEITE	C/RAD C/RAD C/RAD C/RAD C/RAD	4 CIL. 1.8 L	

				
4 CIL, 1.8 L	1997	K060365 T260 CH-220593 CH-227182 CH-227181 31100	ALT. BANDA ARBOL DE LEVAS MANGUERA DE PASO MANGUERA INF. MANGUERA SUP. TAPON DE ACEITE	C/RAD C/RAD C/RAD C/RAD C/RAD

				
2005	T260 7270 7295 CH-220832 CH-220702 CH-220711 K060355 K060455 T41079	BANDA ARBOL DE LEVAS BANDA EN V BANDA EN V MANGUERA INF. MANGUERA INF. MANGUERA SUP. SERPENTIN SERPENTIN TENSOR ARBOL DE LEVAS	D.H. D.H.	

**CRAFTER**

5 CIL, 2.5 L TDI	2010	T321 K061020 K060790 T43067 TH13287G1	BANDA ARBOL DE LEVAS SERPENTIN SERPENTIN TENSOR TERMOSTATOS	141 D X 25 MM	4 CIL, 1.8 L
5 CIL, 2.5 L TDI	2009	T321 K061020 K060790 T43067 TH13287G1	BANDA ARBOL DE LEVAS SERPENTIN SERPENTIN TENSOR TERMOSTATOS	141 D X 25 MM	4 CIL, 2.0 L
5 CIL, 2.5 L TDI	2008	T321 K061020 K060790 T43067 TH13287G1	BANDA ARBOL DE LEVAS SERPENTIN SERPENTIN TENSOR TERMOSTATOS	141 D X 25 MM CON A.A. SIN A.A.	4 CIL, 1.8 L

**CROSSFOX**

4 CIL, 1.6 L	2008	T1548 TCK1548 K060669 K060420 TMV-23001	BANDA ARBOL DE LEVAS KIT DE DISTRIBUCION SERPENTIN SERPENTIN TENSOR MICRO-V	{135 D x 19 mm}	4 CIL, 2.0 L
4 CIL, 1.6 L	2007	T1548 TCK1548 K060669 K060420 TMV-23001	BANDA ARBOL DE LEVAS KIT DE DISTRIBUCION SERPENTIN SERPENTIN TENSOR MICRO-V	CON A.A. SIN A.A.	4 CIL, 1.8 L
4 CIL, 1.6 L	2006	T1548 TCK1548 K060669 K060420 TMV-23001	BANDA ARBOL DE LEVAS KIT DE DISTRIBUCION SERPENTIN SERPENTIN TENSOR MICRO-V	CON A.A. SIN A.A.	4 CIL, 1.8 L
4 CIL, 1.6 L	2005	TCK1548 K060669 K060420	KIT DE DISTRIBUCION SERPENTIN SERPENTIN	C/AA y C/DH S/AA y S/DH	











**DERBY**





4 CIL, 1.8 L	2008	T260 7295 7270 CH-220832 CH-220702 CH-220711 K060455 K060355 T41079	BANDA ARBOL DE LEVAS D.H. D.H. MANGUERA INF. MANGUERA INF. MANGUERA SUP. SERPENTIN SERPENTIN TENSOR ARBOL DE LEVAS	CON A.A. SIN A.A. CON A.A. SIN A.A. SIN A.A.	4 CIL, 1.8 L
4 CIL, 1.8 L	2007	T260 7270 7295 CH-220832 CH-220702 CH-220711 K060355 K060455 T41079	BANDA ARBOL DE LEVAS D.H. D.H. MANGUERA INF. MANGUERA INF. MANGUERA SUP. SERPENTIN SERPENTIN TENSOR ARBOL DE LEVAS	SIN A.A. CON A.A. CON A.A. SIN A.A. SIN A.A.	
4 CIL, 1.8 L	2006	T260 7270 7295 CH-220832 CH-220702 CH-220711 K060355 K060455 T41079	BANDA ARBOL DE LEVAS D.H. D.H. MANGUERA INF. MANGUERA INF. MANGUERA SUP. SERPENTIN SERPENTIN TENSOR ARBOL DE LEVAS	D.H., S/AA SIN A.A. CON A.A. CON A.A. SIN A.A. SIN A.A.	











**EUROVAN**

4 CIL, 1.9 L DIESEL	2009	T333 T41229 6DPK1200 K060441 T43091	BANDA ARBOL DE LEVAS POLEA DE DISTRIBUCION SERPENTIN SERPENTIN TENSOR	CON A.A. SIN A.A.	
4 CIL, 1.9 L DIESEL	2008	T333 T41229 6DPK1200 K060441 T43091	BANDA ARBOL DE LEVAS POLEA SERPENTIN SERPENTIN TENSOR PARA BANDA	C/AA SIN A.A.	
4 CIL, 1.9 L DIESEL	2007	T333 T43091 T41229 6DPK1200 K060441	BANDA ARBOL DE LEVAS POLEA POLEA SERPENTIN SERPENTIN	C/AA SIN A.A.	
4 CIL, 1.9 L DIESEL	2006	T333	BANDA ARBOL DE LEVAS		



    				    										
4 CIL, 1.9 L DIESEL	2006	T43091 T41229 6DPK1200 K060441	POLEA POLEA LOCA SERPENTIN SERPENTIN	C/AA S/AA	4 CIL, 1.6 L	2009	TCK1548 TPG-23001 T1548 TCK1548 TPG-23001	KIT DE DISTRIBUCION TENSOR BANDA ARBOL DE LEVAS KIT DE DISTRIBUCION TENSOR	135 D X 19 MM					
5 CIL, 2.5 L	2006	CH-220772 CH-220762 K060870 K060532	MANG. SUP. MANG. SUP. SERPENTIN SERPENTIN	MANG. LARGA MANG. MANG. CORTA MANG. ALT., C/AA S/AA	<b>GOLF</b>									
4 CIL, 1.9 L DIESEL	2005	T333 T41229 6DPK1200 K060441	BANDA ARBOL DE LEVAS POLEA SERPENTIN SERPENTIN	C/AA S/AA	4 CIL, 1.8 L	2006	T306 22808 22879 38018 6DPK1200	BANDA ARBOL DE LEVAS MANG. INF. MANG. SUP. POLEA TENSORA SERPENTIN						
5 CIL, 2.5 L	2005	T43091 CH-220762 CH-220772 K060870 K060532	TENSOR ARBOL DE LEVAS MANGUERA SUP. MANGUERA SUP. SERPENTIN SERPENTIN		4 CIL, 2.0 L	2006	31100 31833 31529 38148 T334 T296 TCK296 22808 22875 22876	TAPON DE ACEITE BANDA ARBOL DE LEVAS BANDA ARBOL DE LEVAS KIT DE DISTRIBUCION MANG. INF. MANG. SUP. MANG. SUP.	SIN LLAVE REGULAR (22 lbs) Sin Palanca C/TURBO C/AA RAD A T" T" A MOTOR"					
5 CIL, 2.5 L	2004	K060530 K060870 TPG-22001	SERPENTIN SERPENTIN TENSOR ARBOL DE LEVAS	S/AA C/AA	4 CIL, 1.8 L	2005	38018 K060415 31100 31833 31529 T43010 38148 33923	POLEA SERPENTIN TAPON DE ACEITE TAPON DE GASOLINA TAPON DE RADIADOR TENSOR ARBOL DE LEVAS TENSOR MICRO-V TERMOSTATO	SIN LLAVE REGULAR (22 lbs) Sin Palanca 195°F					
6 CIL, 2.8 L	2004	DK070551	SERPENTIN	S/AA	4 CIL, 2.0 L	2005	T306 22808 22879 38018 6DPK1200	BANDA ARBOL DE LEVAS MANGUERA INF. MANGUERA SUP. POLEA TENSORA SERPENTIN						
5 CIL, 2.5 L	2003	K060532 T739 CH-220762 CH-220751 CH-220741 K060840 K060870	ALT. BANDA ARBOL DE LEVAS MANG. INF. MANG. SUP. MANG. SUP. SERPENTIN SERPENTIN	S/AA S/AA S/AA, C/CONEXION A T" 1 D S/AA, MANG. CORTA 2 DE 2 M S/AA, MANG. CORTA 1 DE 2 M ALT. S/AA ALT., C/AA	4 CIL, 1.8 L	2005	31100 31833 31781 TPG-22001 K060532 T739 CH-220762 CH-220772 CH-220751 CH-220741 K060840 K060870	TAPON DE ACEITE TAPON DE GASOLINA TAPON DE GASOLINA TENSOR ARBOL DE LEVAS ALT. BANDA ARBOL DE LEVAS MANGUERA INF. MANGUERA INF. MANGUERA SUP. MANGUERA SUP. SERPENTIN SERPENTIN	SIN LLAVE REGULAR CON LLAVE REGULAR S/AA S/AA S/AA S/AA S/AA ALT. S/AA ALT., C/AA					
5 CIL, 2.5 L	2002	K060532 T739 CH-220762 CH-220772 CH-220751 CH-220741 K060840 K060870	ALT. BANDA ARBOL DE LEVAS MANGUERA INF. MANGUERA INF. MANGUERA SUP. MANGUERA SUP. SERPENTIN SERPENTIN	S/AA S/AA S/AA S/AA S/AA S/AA ALT. S/AA ALT., C/AA	4 CIL, 2.0 L	2005	31100 31781 31833 TPG-22001 K060532 T739 CH-220772 CH-220762 CH-220741 CH-220751 K060840 K060870	TAPON DE ACEITE TAPON DE GASOLINA TAPON DE GASOLINA TENSOR ARBOL DE LEVAS ALT. BANDA ARBOL DE LEVAS MANGUERA INF. MANGUERA INF. MANGUERA SUP. MANGUERA SUP. POLEA SERPENTIN SERPENTIN	SIN LLAVE REGULAR (22 lbs) Sin Palanca 195°F					
5 CIL, 2.5 L	2001	K060532 T739 CH-220772 CH-220762 CH-220741 CH-220751 K060840 K060870 31100 31833 31781 TPG-22001	ALT. BANDA ARBOL DE LEVAS MANGUERA INF. MANGUERA INF. MANGUERA SUP. MANGUERA SUP. SERPENTIN SERPENTIN TAPON DE ACEITE TAPON DE GASOLINA TAPON DE GASOLINA TENSOR ARBOL DE LEVAS	S/AA S/AA {122 D x 26.5 mm} S/AA S/AA S/AA S/AA ALT. S/AA ALT., C/AA	4 CIL, 1.8 L	2004	22808 22875 22876 38018 6DPK1200 K060441 31100 31833 31529 T43010 38148 33923	MANGUERA SUP. MANGUERA SUP. MANGUERA SUP. POLEA SERPENTIN SERPENTIN TAPON DE ACEITE TAPON DE GASOLINA TAPON DE RADIADOR TENSOR ARBOL DE LEVAS TENSOR MICRO-V TERMOSTATO	SIN LLAVE REGULAR (22 lbs) Sin Palanca 195°F					
<b>GLI</b>					4 CIL, 2.0 L TURBO	2008	T334 T42019 K060415 31781 31833 31529	BANDA ARBOL DE LEVAS POLEA LOCA DISTRIBUCION SERPENTIN TAPON DE GASOLINA TAPON DE GASOLINA TAPON DE RADIADOR	CON LLAVE 22 LIBRAS {148 D x 23 mm}	4 CIL, 2.0 L	2004	T296 TCK296 22808 38018 6DPK1200 K060441 31100 31833 31529 38148 33923	BANDA ARBOL DE LEVAS KIT DE DISTRIBUCION MANGUERA INF. POLEA SERPENTIN SERPENTIN TAPON DE ACEITE TAPON DE GASOLINA TAPON DE RADIADOR TENSOR MICRO-V TERMOSTATO	SIN LLAVE REGULAR (22 lbs) Sin Palanca 195°F {138 D x 23.0 mm}
<b>GOL</b>					4 CIL, 2.0 L TURBO	2007	T334 T42019 K060415 31781 31833 31529	BANDA ARBOL DE LEVAS POLEA LOCA DISTRIBUCION SERPENTIN TAPON DE GASOLINA TAPON DE GASOLINA TAPON DE RADIADOR	CON LLAVE 22 LIBRAS	4 CIL, 1.6 L	2010	T1548	BANDA ARBOL DE LEVAS	135 D X 19 MM

									
4 CIL, 2.0 L	2004	31529	TAPON DE RADIADOR	(22 lbs) Sin Palanca		38148	SENSOR MICRO-V		
		T43010	TENSOR ARBOL DE LEVAS			33923	TERMOSTATO	195°F	
		38148	TENSOR MICRO-V		4 CIL, 1.8 L	2000	T306	BANDA ARBOL DE LEVAS	
4 CIL, 1.8 L	2003	33923	TERMOSTATO	195°F		CH-220034	MANGUERA DE CALEF.	C/AA, S/AA	
		T306	BANDA ARBOL DE LEVAS			CH-220054	MANGUERA DE CALEF.	C/AA, S/AA	
		T296	BANDA ARBOL DE LEVAS			CH-220064	MANGUERA DE CALEF.	C/AA, S/AA	
		22808	MANG. INF.	C/TRANS MANUAL		CH-220073	MANGUERA DE PASO	C/AA, S/AA	
		22880	MANG. SUP.	T" A MOTOR"		CH-220333	MANGUERA DE PASO	C/AA, S/AA	
		22879	MANG. SUP.	RAD A T"		CH-220083	MANGUERA DE PASO	C/AA, S/AA	
		22615	MANGUERA INF.			CH-220663	MANGUERA DE PASO	C/AA, S/AA	
		22407	MANGUERA SUP.			CH-220593	MANGUERA DE PASO	C/AA, S/AA	
		38018	POLEA			CH-229182	MANGUERA INF.	S/AA	
		6DPK1200	SERPENTIN	ALT., C/AA		CH-228182	MANGUERA INF.	C/AA	
		31100	TAPON DE ACEITE			12T150	MANGUERA INF. FLEXIBLE	C/AA	
		31833	TAPON DE GASOLINA	SIN LLAVE REGULAR		CH-229181	MANGUERA SUP.	S/AA	
		31529	TAPON DE RADIADOR	(22 lbs) Sin Palanca		CH-228181	MANGUERA SUP.	C/AA	
		38148	TENSOR MICRO-V			12T232	MANGUERA SUP. FLEXIBLE	C/AA	
		33923	TERMOSTATO	195°F		37013P	POLEA DECOPLADORA		
4 CIL, 2.0 L	2003	T296	BANDA ARBOL DE LEVAS			38018	POLEA DEL TENSOR		
		TCK296	KIT DE DISTRIBUCION			6DPK1200	SERPENTIN	C/AA	
		22615	MANGUERA INF.			K060441	SERPENTIN	S/AA	
		22407	MANGUERA SUP.			31100	TAPON DE ACEITE		
		38018	POLEA			31833	TAPON DE GASOLINA	SIN LLAVE REGULAR	
		37013P	POLEA DECOPLADORA			31781	TAPON DE GASOLINA	CON LLAVE REGULAR	
		6DPK1200	SERPENTIN	ALTERNADOR C/AA		31529	TAPON DE RADIADOR	(22 lbs) Sin Palanca	
		K060441	SERPENTIN	ALTERNADOR S/AA		38148	TENSOR MICRO-V		
		31100	TAPON DE ACEITE			33923	TERMOSTATO	195°F	
		31833	TAPON DE GASOLINA	SIN LLAVE REGULAR	4 CIL, 2.0 L	2000	K060455	ALT & A.A.	S/Micro-V doble
		31529	TAPON DE RADIADOR	(22 lbs) Sin Palanca			K060408	ALT.	S/AA, S/DH
		T43010	TENSOR ARBOL DE LEVAS				K060454	ALT.	C/AA, C/DH
		38148	TENSOR MICRO-V				K060385	BA Y ALT	S/AA, S/Micro-V doble
		33923	TERMOSTATO	195°F			7295	BA Y D.H.	S/Micro-V doble
4 CIL, 2.0 L	2002	T296	BANDA ARBOL DE LEVAS				340J2	BANDA	VENT., S/AA, S/DH
		TCK296	KIT DE DISTRIBUCION				T296	BANDA ARBOL DE LEVAS	
		22808	MANG. INF.				T262	BANDA ARBOL DE LEVAS	{124 D x 18.0 mm}
		22876	MANG. SUP.	TEE A MOTOR			6294 GS	D.H.	C/AA, C/DH
		22875	MANG. SUP.	RAD A TEE			TCK262	KIT DE DISTRIBUCION	
		38018	POLEA				TCK296	KIT DE DISTRIBUCION	
		37013P	POLEA DECOPLADORA				22808	MANG. INF.	NUEVO DISEÑO C/AA
		6DPK1200	SERPENTIN	ALT., C/AA			22279	MANGUERA INF.	C/AA
		K060441	SERPENTIN	ALT., S/AA			22278	MANGUERA INF.	C/AA
		31100	TAPON DE ACEITE				22474	MANGUERA INF.	S/AA
		31833	TAPON DE GASOLINA	SIN LLAVE REGULAR			CH-228182	MANGUERA INF.	C/AA
		31529	TAPON DE RADIADOR	(22 lbs) Sin Palanca			CH-220721	MANGUERA SUP.	C/AA, S/AA
		T43010	TENSOR ARBOL DE LEVAS				CH-220731	MANGUERA SUP.	C/AA, S/AA
		38148	TENSOR MICRO-V				38087	POLEA	ALT. Y A.A.
		33923	TERMOSTATO	195°F			38018	POLEA	
4 CIL, 1.8 L	2001	T306	BANDA ARBOL DE LEVAS				37013P	POLEA DECOPLADORA	
		22808	MANG. INF.				31100	TAPON DE ACEITE	
		22879	MANG. SUP.	RAD A TEE			31781	TAPON DE GASOLINA	CON LLAVE REGULAR
		22880	MANG. SUP.	TEE A MOTOR			31833	TAPON DE GASOLINA	SIN LLAVE REGULAR
		37013P	POLEA DECOPLADORA				31529	TAPON DE RADIADOR	(22 lbs) Sin Palanca
		38018	POLEA DEL TENSOR				T41079	TENSOR ARBOL DE LEVAS	
		6DPK1200	SERPENTIN	C/AA			T43010	TENSOR ARBOL DE LEVAS	
		31100	TAPON DE ACEITE				38147	TENSOR MICRO-V	S/Micro-V doble
		31781	TAPON DE GASOLINA	CON LLAVE REGULAR			38148	TENSOR MICRO-V	
		31833	TAPON DE GASOLINA	SIN LLAVE REGULAR			33923	TERMOSTATO	195°F
		31529	TAPON DE RADIADOR	(22 lbs) Sin Palanca			340J2	VENTILADOR	S/AA, S/DH
		38148	TENSOR MICRO-V				340J2	VENTILADOR	C/AA, C/DH
		33923	TERMOSTATO	195°F	V-6, 2.8 L	2000	K060739	ALT.	C/AA, C/DH
4 CIL, 2.0 L	2001	T296	BANDA ARBOL DE LEVAS				T297	BANDA ARBOL DE LEVAS	C/AA, C/DH
		TCK296	KIT DE DISTRIBUCION				31100	TAPON DE ACEITE	
		22278	MANGUERA INF.	C/AA			31833	TAPON DE GASOLINA	SIN LLAVE REGULAR
		22474	MANGUERA INF.	S/AA			31781	TAPON DE GASOLINA	CON LLAVE REGULAR
		CH-228182	MANGUERA INF.	C/AA			31529	TAPON DE RADIADOR	(22 lbs) Sin Palanca
		CH-220721	MANGUERA SUP.	C/AA, S/AA			38175	TENSOR MICRO-V	
		CH-220731	MANGUERA SUP.	C/AA, S/AA			33078	TERMOSTATO	180°F
		38018	POLEA		4 CIL, 1.8 L	1999	K060355	ALT.	S/AA, C/DH
		37013P	POLEA DECOPLADORA				K060454	ALT.	C/AA, C/DH
		6DPK1200	SERPENTIN	C/AA			T260	BANDA ARBOL DE LEVAS	C/AA, C/DH
		31100	TAPON DE ACEITE				7277 GS	D.H.	S/AA, C/DH
		31833	TAPON DE GASOLINA	SIN LLAVE REGULAR			7306 GS	D.H.	C/AA, C/DH
		31781	TAPON DE GASOLINA	CON LLAVE REGULAR			CH-220054	MANGUERA DE CALEF.	C/AA, S/AA
		31529	TAPON DE RADIADOR	(22 lbs) Sin Palanca			CH-220034	MANGUERA DE CALEF.	C/AA, S/AA
		T43010	TENSOR ARBOL DE LEVAS				CH-220064	MANGUERA DE CALEF.	C/AA, S/AA

    				    					
4 CIL, 1.8 L	1999	CH-220593	MANGUERA DE PASO	C/AA, S/AA	4 CIL, 2.0 L	K060408	ALT.	S/AA, S/DH	
		CH-220083	MANGUERA DE PASO	C/AA, S/AA			K060454	ALT.	C/AA, C/DH
		CH-220333	MANGUERA DE PASO	C/AA, S/AA			T262	BANDA ARBOL DE LEVAS	C/AA, C/DH
		CH-220663	MANGUERA DE PASO	C/AA, S/AA			6294 GS	D.H.	C/AA, C/DH
		CH-220073	MANGUERA DE PASO	C/AA, S/AA			92029	EDH	PRESION
		CH-228182	MANGUERA INF.	C/AA, S/AA			TCK262	KIT DE DISTRIBUCION	
		12T150	MANGUERA INF. FLEXIBLE	C/AA			22474	MANG. INF.	S/AA
		CH-228181	MANGUERA SUP.	C/AA			22279	MANGUERA INF.	C/AA
		CH-229181	MANGUERA SUP.	S/AA			CH-220721	MANGUERA SUP.	C/AA
		12T232	MANGUERA SUP. FLEXIBLE	C/AA			CH-220731	MANGUERA SUP.	S/AA
		31100	TAPON DE ACEITE				38087	POLEA	ALT. Y A.A.
		31833	TAPON DE GASOLINA	SIN LLAVE REGULAR			31100	TAPON DE ACEITE	
		31781	TAPON DE GASOLINA	CON LLAVE REGULAR			31781	TAPON DE GASOLINA	CON LLAVE REGULAR
		31328	TAPON DE RADIADOR	(20 lbs) Sin palanca			31833	TAPON DE GASOLINA	SIN LLAVE REGULAR
		31529	TAPON DE RADIADOR	(22 lbs) Sin Palanca			31328	TAPON DE RADIADOR	(20 lbs) Sin palanca
		33923	TERMOSTATO	195°F			T41079	SENSOR ARBOL DE LEVAS	
		4 CIL, 2.0 L	1999	K060408			ALT.	S/AA, S/DH	V-6, 2.8 L
K060454	ALT.			C/AA, C/DH	T297	BANDA ARBOL DE LEVAS	C/AA, C/DH		
K060385	BA Y ALT			S/AA; S/Micro-V doble	31781	TAPON DE GASOLINA	CON LLAVE REGULAR		
7295	BA Y D.H.			S/Micro-V doble	31833	TAPON DE GASOLINA	SIN LLAVE REGULAR		
T262	BANDA ARBOL DE LEVAS			{124 D x 18.0 mm}	31328	TAPON DE RADIADOR	(20 lbs) Sin palanca		
T296	BANDA ARBOL DE LEVAS				38175	SENSOR MICRO-V			
6294 GS	D.H.			C/AA, C/DH	K060355	ALT.	S/AA, C/DH		
92029	EDH			PRESION	K060454	ALT.	C/AA, C/DH		
TCK262	KIT DE DISTRIBUCION				T260	BANDA ARBOL DE LEVAS	C/AA, C/DH		
TCK296	KIT DE DISTRIBUCION				BDH-5128	BOMBA DE DIR. HIDR.			
22278	MANGUERA INF.			C/AA	7277 GS	D.H.	S/AA, C/DH		
22279	MANGUERA INF.			C/AA	7306 GS	D.H.	C/AA, C/DH		
22474	MANGUERA INF.			S/AA	92030	EDH	PRESION		
CH-228182	MANGUERA INF.			C/AA	CH-220054	MANGUERA DE CALEF.	C/AA, S/AA		
CH-220731	MANGUERA SUP.			C/AA, S/AA	CH-220034	MANGUERA DE CALEF.	C/AA, S/AA		
CH-220721	MANGUERA SUP.			C/AA, S/AA	CH-220064	MANGUERA DE CALEF.	C/AA, S/AA		
38018	POLEA				CH-220083	MANGUERA DE PASO	C/AA, S/AA		
38087	POLEA	ALT. Y A.A.	CH-220663	MANGUERA DE PASO	C/AA, S/AA				
31100	TAPON DE ACEITE		CH-220333	MANGUERA DE PASO	C/AA, S/AA				
31781	TAPON DE GASOLINA	CON LLAVE REGULAR	CH-220073	MANGUERA DE PASO	C/AA, S/AA				
31833	TAPON DE GASOLINA	SIN LLAVE REGULAR	CH-220593	MANGUERA DE PASO	C/AA, S/AA				
31328	TAPON DE RADIADOR	(20 lbs) Sin palanca	CH-228182	MANGUERA INF.	C/AA				
T43010	SENSOR ARBOL DE LEVAS		CH-229182	MANGUERA INF.	S/AA				
T41079	SENSOR ARBOL DE LEVAS		12T150	MANGUERA INF. FLEXIBLE	C/AA				
38148	SENSOR MICRO-V		CH-229181	MANGUERA SUP.	S/AA				
38147	SENSOR MICRO-V	S/DOBLE MICRO V	CH-228181	MANGUERA SUP.	C/AA				
33208	TERMOSTATO	180°F	12T232	MANGUERA SUP. FLEXIBLE	C/AA				
33923	TERMOSTATO	195°F	31100	TAPON DE ACEITE					
340J2	VENTILADOR	S/AA, S/DH	31833	TAPON DE GASOLINA	SIN LLAVE REGULAR				
340J2	VENTILADOR	C/AA, C/DH	31781	TAPON DE GASOLINA	CON LLAVE REGULAR				
V-6, 2.8 L	1999	K060739	ALT.	C/AA, C/DH	4 CIL, 1.8 L	1997	K060408	ALT.	S/AA, S/DH
		T297	BANDA ARBOL DE LEVAS	C/AA, C/DH			K060454	ALT.	C/AA, C/DH
		31100	TAPON DE ACEITE				T262	BANDA ARBOL DE LEVAS	C/AA, C/DH
		31781	TAPON DE GASOLINA	CON LLAVE REGULAR			BDH-5128	BOMBA DE DIR. HIDR.	
		31833	TAPON DE GASOLINA	SIN LLAVE REGULAR			6294 GS	D.H.	C/AA, C/DH
		31328	TAPON DE RADIADOR	(20 lbs) Sin palanca			92029	EDH	PRESION
		38175	SENSOR MICRO-V				TCK262	KIT DE DISTRIBUCION	
		K060355	ALT.	S/AA, C/DH			22278	MANG. INF.	IMP. C/AA
		K060454	ALT.	C/AA, C/DH			22474	MANG. INF.	IMP. S/AA
		T260	BANDA ARBOL DE LEVAS	C/AA, C/DH			22277	MANG. SUP.	IMP
		7306 GS	D.H.	C/AA, C/DH			CH-228182	MANGUERA INF.	C/AA
		7277 GS	D.H.	S/AA, C/DH			CH-220551	MANGUERA SUP.	C/AA
		CH-220054	MANGUERA DE CALEF.	C/AA, S/AA			38087	POLEA	ALT. Y A.A.
		CH-220034	MANGUERA DE CALEF.	C/AA, S/AA			31100	TAPON DE ACEITE	
		CH-220064	MANGUERA DE CALEF.	C/AA, S/AA			31781	TAPON DE GASOLINA	CON LLAVE REGULAR
		CH-220663	MANGUERA DE PASO	C/AA, S/AA			31833	TAPON DE GASOLINA	SIN LLAVE REGULAR
		CH-220083	MANGUERA DE PASO	C/AA, S/AA			31328	TAPON DE RADIADOR	(20 lbs) Sin palanca
CH-220073	MANGUERA DE PASO	C/AA, S/AA	33209	TERMOSTATO	195°F				
CH-220593	MANGUERA DE PASO	C/AA, S/AA	K060408	ALT.	S/AA, S/DH				
CH-220333	MANGUERA DE PASO	C/AA, S/AA	K060454	ALT.	C/AA, C/DH				
CH-229182	MANGUERA INF.	S/AA	T262	BANDA ARBOL DE LEVAS	C/AA, C/DH				
CH-228182	MANGUERA INF.	C/AA	BDH-5128	BOMBA DE DIR. HIDR.					
12T150	MANGUERA INF. FLEXIBLE	C/AA	6294 GS	D.H.	C/AA, C/DH				
CH-229181	MANGUERA SUP.	S/AA	92029	EDH	PRESION				
CH-228181	MANGUERA SUP.	C/AA	TCK262	KIT DE DISTRIBUCION					
12T232	MANGUERA SUP. FLEXIBLE	C/AA	22278	MANG. INF.	IMP. C/AA				
31781	TAPON DE GASOLINA	CON LLAVE REGULAR	22474	MANG. INF.	IMP. S/AA				
31833	TAPON DE GASOLINA	SIN LLAVE REGULAR	22277	MANG. SUP.	IMP				
31328	TAPON DE RADIADOR	(20 lbs) Sin palanca	CH-228182	MANGUERA INF.	C/AA				
			CH-220551	MANGUERA SUP.	C/AA				
			38087	POLEA	ALT. Y A.A.				
			31100	TAPON DE ACEITE					
			31781	TAPON DE GASOLINA	CON LLAVE REGULAR				
			31833	TAPON DE GASOLINA	SIN LLAVE REGULAR				
			31328	TAPON DE RADIADOR	(20 lbs) Sin palanca				
			T41079	SENSOR ARBOL DE LEVAS					
			38147	SENSOR MICRO-V					
			33209	TERMOSTATO	195°F				
			340J2	VENTILADOR	S/AA, S/DH				
			340J2	VENTILADOR	C/AA, C/DH				













GTI					GTI				
4 CIL, 2.0 L TURBO	2008	T334	BANDA ARBOL DE LEVAS		4 CIL, 2.0 L	2009	38018	POLEA	CON TURBO
		T42019	POLEA LOCA DISTRIBUCION				K060415	SERPENTIN	CON TURBO
		K060415	SERPENTIN				DK060472	SERPENTIN	
		31833	TAPON DE GASOLINA				31100	TAPON DE ACEITE	
		31781	TAPON DE GASOLINA	CON LLAVE			31613	TAPON DE GASOLINA	CON LLAVE
		31529	TAPON DE RADIADOR	22 LIBRAS			31708	TAPON DE GASOLINA	CON LLAVE
							31529	TAPONES DE RADIADOR	22 LBS.
							38148	SENSOR	
							38148	BANDA ARBOL DE LEVAS	148 D X 23 MM CON TURBO
4 CIL, 2.0 L TURBO	2007	T334	BANDA ARBOL DE LEVAS		4 CIL, 2.0 L	2009	T334	BANDA ARBOL DE LEVAS	148 D X 23 MM
		T42019	POLEA LOCA DISTRIBUCION				T296	BANDA ARBOL DE LEVAS	138 D X 23 MM
		K060415	SERPENTIN				TCK296	KIT DE DISTRIBUCION	
		31833	TAPON DE GASOLINA				22808	MANGUERA INF.	
		31781	TAPON DE GASOLINA	CON LLAVE			22875	MANGUERA SUP.	RADIADOR A T
		31529	TAPON DE RADIADOR	22 LIBRAS			22876	MANGUERA SUP.	T A MOTOR
							38018	POLEA	CON TURBO
							K060415	SERPENTIN	CON TURBO
							DK060472	SERPENTIN	CON TURBO
V-6, 2.8 L	2001	19661	CALEF. A "T"-2		V-6, 2.8 L	2001	31100	TAPON DE ACEITE	
		7DPK1363	SERPENTIN	C/AA			31708	TAPON DE GASOLINA	CON LLAVE
		31100	TAPON DE ACEITE				31613	TAPON DE GASOLINA	
		31833	TAPON DE GASOLINA	SIN LLAVE REGULAR			31529	TAPONES DE RADIADOR	22 LBS.
		31529	TAPON DE RADIADOR	(22 lbs) Sin Palanca			38148	SENSOR	
		38175	TENSOR MICRO-V				T334	BANDA ARBOL DE LEVAS	CON TURBO
		33209	TERMOSTATO	195°F			T296	BANDA ARBOL DE LEVAS	SIN TURBO
							TCK296	KIT DE DISTRIBUCION	
							22808	MANGUERA INF.	
4 CIL, 2.0 L	2000	K060455	ALT & A.A.	S/Micro-V doble	4 CIL, 2.0 L	2008	22876	MANGUERA SUP.	"T" A MOTOR
		K060385	BA Y ALT	S/AA; S/Micro-V doble			22875	MANGUERA SUP.	RADIADOR A "T"
		7295	BA Y D.H.	S/Micro-V doble			38018	POLEA	
		T296	BANDA ARBOL DE LEVAS				K060415	SERPENTIN	CON TURBO
		T262	BANDA ARBOL DE LEVAS	{124 D x 18.0 mm}			DK060472	SERPENTIN	SIN TURBO
		TCK262	KIT DE DISTRIBUCION				31100	TAPON DE ACEITE	
		22278	MANGUERA INF.	C/AA			31781	TAPON DE GASOLINA	
		22474	MANGUERA INF.	S/AA			31833	TAPON DE GASOLINA	
		6DPK1200	SERPENTIN	DOBLE PERFIL			31529	TAPON DE RADIADOR	
V-6, 2.8 L	2000	31100	TAPON DE ACEITE		V-6, 2.8 L	2000	38148	TENSOR MICRO-V	
		31833	TAPON DE GASOLINA	SIN LLAVE REGULAR			33923	TERMOSTATO	190°F
		31529	TAPON DE RADIADOR	(22 lbs) Sin Palanca					
		38147	TENSOR MICRO-V	S/Micro-V doble			38148	BANDA ARBOL DE LEVAS	
		33923	TERMOSTATO	195°F			T333	BANDA ARBOL DE LEVAS	
		19661	CALEF. A "T"-2				T41229	POLEA	
		7DPK1363	SERPENTIN	C/AA			38018	POLEA	
		31100	TAPON DE ACEITE				K060415	SERPENTIN	
		31833	TAPON DE GASOLINA	SIN LLAVE REGULAR			T43091	TENSOR ARBOL DE LEVAS	
4 CIL, 2.0 L	1999	31529	TAPON DE RADIADOR	(22 lbs) Sin Palanca	4 CIL, 2.0 L	2007	T334	BANDA ARBOL DE LEVAS	CON TURBO
		38175	TENSOR MICRO-V				T296	BANDA ARBOL DE LEVAS	SIN TURBO
		33209	TERMOSTATO	195°F			60401	EDH	PRESION
		K060455	ALT & A.A.	S/Micro-V doble			TCK296	KIT DE DISTRIBUCION	
		K060385	BA Y ALT	S/AA; S/Micro-V doble			22808	MANGUERA INF.	
		7295	BA Y D.H.	S/Micro-V doble			22875	MANGUERA SUP.	RADIADOR A "T"
		T296	BANDA ARBOL DE LEVAS				22876	MANGUERA SUP.	"T" A MOTOR
		T262	BANDA ARBOL DE LEVAS	{124 D x 18.0 mm}			38018	POLEA	
		92030	EDH	PRESION			K060415	SERPENTIN	CON TURBO
V-6, 2.8 L	1999	TCK262	KIT DE DISTRIBUCION		V-6, 2.8 L	1999	DK060472	SERPENTIN	SIN TURBO
		22278	MANGUERA INF.	C/AA			31100	TAPON DE ACEITE	
		22474	MANGUERA INF.	S/AA			31833	TAPON DE GASOLINA	
		31100	TAPON DE ACEITE				31781	TAPON DE GASOLINA	
		31833	TAPON DE GASOLINA	SIN LLAVE REGULAR			31529	TAPON DE RADIADOR	
		31529	TAPON DE RADIADOR	(22 lbs) Sin Palanca			38148	TENSOR MICRO-V	
		38147	TENSOR MICRO-V	S/Micro-V doble			33923	TERMOSTATO	190°F
		33923	TERMOSTATO	195°F					
		19661	CALEF. A "T"-2				T306	BANDA ARBOL DE LEVAS	
4 CIL, 2.0 L	2010	T296	BANDA ARBOL DE LEVAS	138 D X 23 MM	4 CIL, 2.0 L	2006	T306	BANDA ARBOL DE LEVAS	
		T334	BANDA ARBOL DE LEVAS	148 D X 23 MM CON TURBO			60401	EDH	PRESION
		TCK296	KIT DE DISTRIBUCION				22808	MANG. INF.	C/AA, TRANS. MAN.
		22808	MANGUERA INF.				22879	MANG. SUP.	
		22875	MANGUERA SUP.	RADIADOR A T			38018	POLEA	
		22876	MANGUERA SUP.	T A MOTOR			6DPK1200	SERPENTIN	
							31100	TAPON DE ACEITE	
							31833	TAPON DE GASOLINA	SIN LLAVE REGULAR
							31529	TAPON DE RADIADOR	(22 lbs) Sin Palanca
4 CIL, 2.0 L	2010	T296	BANDA ARBOL DE LEVAS	138 D X 23 MM	4 CIL, 2.0 L	2006	T333	BANDA ARBOL DE LEVAS	190°F
		T334	BANDA ARBOL DE LEVAS	148 D X 23 MM CON TURBO			T41229	POLEA	{120 D x 30 mm}
		TCK296	KIT DE DISTRIBUCION				38018	POLEA	
		22808	MANGUERA INF.				K060415	SERPENTIN	
		22875	MANGUERA SUP.	RADIADOR A T			T43091	TENSOR ARBOL DE LEVAS	
		22876	MANGUERA SUP.	T A MOTOR			T296	BANDA ARBOL DE LEVAS	











## JETTA











4 CIL, 2.0 L	2010	T296	BANDA ARBOL DE LEVAS	138 D X 23 MM	4 CIL, 1.9 L DIESEL	2006	T333	BANDA ARBOL DE LEVAS	190°F
		T334	BANDA ARBOL DE LEVAS	148 D X 23 MM CON TURBO			T41229	POLEA	{120 D x 30 mm}
		TCK296	KIT DE DISTRIBUCION				38018	POLEA	
		22808	MANGUERA INF.				K060415	SERPENTIN	
		22875	MANGUERA SUP.	RADIADOR A T			T43091	TENSOR ARBOL DE LEVAS	
		22876	MANGUERA SUP.	T A MOTOR			T296	BANDA ARBOL DE LEVAS	



    				    					
4 CIL, 2.0 L	2006	60401 TCK296 22808 22876 22875 38018 6DPK1200 K060441 31100 31833 31529 38148 33923	EDH KIT DE DISTRIBUCION MANG. INF. MANG. SUP. MANG. SUP. POLEA SERPENTIN SERPENTIN TAPON DE ACEITE TAPON DE GASOLINA TAPON DE RADIADOR SENSOR MICRO-V TERMOSTATO	PRESION  T" A MOTOR" RAD A T"  C/AA S/AA  SIN LLAVE REGULAR (22 lbs) Sin Palanca  195°F	4 CIL, 2.0 L	2004	22884 22880 38018 37013P K060653 DK060472 31100 31781 31833 31529 38148 38192 33209	MANGUERA SUP. MANGUERA SUP. POLEA POLEA SERPENTIN SERPENTIN TAPON DE ACEITE TAPON DE GASOLINA TAPON DE GASOLINA TAPON DE RADIADOR SENSOR MICRO-V TERMOSTATO	RADIADOR A "T" "T" A TERMOSTATO  DECOPLADORA ALTERNAD  DOHC  CON LLAVE  CON DOBLE LADO RANURAL  190°F
4 CIL, 1.8 L	2005	T306 60401 22808 22879 38018 37013P 6DPK1200 31100 31781 31833 31529 38148 33923	BANDA ARBOL DE LEVAS EDH MANGUERA INF. MANGUERA SUP. POLEA POLEA DECOPLADORA SERPENTIN TAPON DE ACEITE TAPON DE GASOLINA TAPON DE GASOLINA TAPON DE RADIADOR SENSOR MICRO-V TERMOSTATO	PRESION      CON LLAVE REGULAR SIN LLAVE REGULAR (22 lbs) Sin Palanca  195°F	4 CIL, 2.0 L	2004	T296 60401 TCK296 22808 38018 37013P 6DPK1200 K060441 31100 31833 31529 T43010 38148 33923	BANDA ARBOL DE LEVAS EDH KIT DE DISTRIBUCION MANGUERA INF. POLEA POLEA DECOPLADORA SERPENTIN SERPENTIN TAPON DE ACEITE TAPON DE GASOLINA TAPON DE RADIADOR SENSOR MICRO-V TERMOSTATO	PRESION      C/AA S/AA  SIN LLAVE REGULAR (22 lbs) Sin Palanca  195°F C/AA
4 CIL, 1.9 L DIESEL	2005	T333 22566 22880 22884 T41229 T43091 38018 DK060472 31100 31781 31833 31529 38148 33209	BANDA ARBOL DE LEVAS MANGUERA INF. MANGUERA SUP. MANGUERA SUP. POLEA POLEA SERPENTIN TAPON DE ACEITE TAPON DE GASOLINA TAPON DE GASOLINA TAPON DE RADIADOR SENSOR MICRO-V TERMOSTATO	PRESION  "T" A TERMOSTATO RADIADOR A "T"    CON LLAVE  190°F	V-6, 2.8 L	2004	DK060519 31100 31833 38175 T306 60401 22808 22879 22880 22615 38018 37013P 6DPK1200 31100 31833 31529 38148 33923	BANDA ARBOL DE LEVAS SERPENTIN TAPON DE ACEITE TAPON DE GASOLINA SENSOR MICRO-V TERMOSTATO SERPENTIN TAPON DE ACEITE TAPON DE GASOLINA TAPON DE RADIADOR SENSOR MICRO-V TERMOSTATO	195°F C/AA  SIN LLAVE REGULAR P/BANDA DE 7 COSTILLAS  PRESION C/AA C/MAN. TRANS. RADIADOR A T" T" A MOTOR"  ALTERNADOR C/AA
4 CIL, 2.0 L	2005	T306 60401 TCK296 35B 5/8" 35B 5/8" 22808 22875 22876 38018 37013P 6DPK1200 K060441 31100 31833 31781 31529 T43010 38148 33923	BANDA ARBOL DE LEVAS EDH KIT DE DISTRIBUCION MANGUERA DE CALEFACCION MANGUERA DE CALEFACCION MANGUERA INF. MANGUERA SUP. MANGUERA SUP. POLEA POLEA DECOPLADORA SERPENTIN SERPENTIN TAPON DE ACEITE TAPON DE GASOLINA TAPON DE GASOLINA TAPON DE RADIADOR SENSOR MICRO-V TERMOSTATO	PRESION      CON LLAVE  190°F	4 CIL, 1.9 L DIESEL	2003	T321 TCK321 22566 22880 22884 37013P K060653 31100 31781 31833 31529 38192 33209	BANDA ARBOL DE LEVAS KIT DE DISTRIBUCION MANGUERA INF. MANGUERA SUP. MANGUERA SUP. POLEA SERPENTIN SERPENTIN TAPON DE ACEITE TAPON DE GASOLINA TAPON DE GASOLINA TAPON DE RADIADOR SENSOR MICRO-V TERMOSTATO	ALTERNADOR C/AA SIN LLAVE REGULAR (22 lbs) Sin Palanca SERPENTIN - C/banda v de dc 195°F  "T" A TERMOSTATO RADIADOR A "T" DECOPLADORA ALTERNAD  CON LLAVE  190°F
4 CIL, 1.8 L	2004	T306 60401 22808 22879 22880 38018 37013P 6DPK1200 31100 31833 31529 38148 33923	BANDA ARBOL DE LEVAS EDH MANGUERA INF. MANGUERA SUP. MANGUERA SUP. POLEA POLEA DECOPLADORA SERPENTIN TAPON DE ACEITE TAPON DE GASOLINA TAPON DE RADIADOR SENSOR MICRO-V TERMOSTATO	PRESION  C/AA Y TANSMISION MANUAI RAD A TEE TEE A MOTOR  C/AA  SIN LLAVE REGULAR (22 lbs) Sin Palanca  195°F	4 CIL, 2.0 L	2003	T296 60401 TCK296 22615 22808 22407 38018 37013P 6DPK1200 K060441 31100 31833 31529 T43010 38148 33923	BANDA ARBOL DE LEVAS EDH KIT DE DISTRIBUCION MANGUERA INF. MANGUERA INF. MANGUERA SUP. POLEA POLEA DECOPLADORA SERPENTIN SERPENTIN TAPON DE ACEITE TAPON DE GASOLINA TAPON DE GASOLINA TAPON DE RADIADOR SENSOR MICRO-V TERMOSTATO	PRESION      ALTERNADOR C/AA ALTERNADOR S/AA  SIN LLAVE REGULAR (22 lbs) Sin Palanca  SERPENTIN - C/banda v de dc 195°F C/AA
4 CIL, 1.9 L DIESEL	2004	T321 TCK321 22566	BANDA ARBOL DE LEVAS KIT DE DISTRIBUCION MANGUERA INF.	195°F	V-6, 2.8 L	2003	DK060519	SERPENTIN	C/AA



									
V-6, 2.8 L	2003	31100	TAPON DE ACEITE		K060653		SERPENTIN		CON A.A.
		31833	TAPON DE GASOLINA	SIN LLAVE REGULAR	K060355		SERPENTIN		SIN A.A.
		38175	SENSOR MICRO-V	P/BANDA DE 7 COSTILLAS	31100		TAPON DE ACEITE		
		33069	TERMOSTATO	195°F	31833		TAPON DE GASOLINA		
4 CIL, 1.8 L	2002	T306	BANDA ARBOL DE LEVAS	PRESION	31781		TAPON DE GASOLINA	CON LLAVE	
		60401	EDH	C/TRANS MANUAL	31529		TAPON DE RADIADOR		
		22808	MANG. INF.	RAD A T"	38192		SENSOR MICRO-V		
		22879	MANG. SUP.	T" A MOTOR"	33209		TERMOSTATO	190°F	
		22880	MANG. SUP.		T296	4 CIL, 2.0 L	BANDA ARBOL DE LEVAS		
		38018	POLEA		60401		EDH	PRESION	
		37013P	POLEA DECOPLADORA		TCK296		KIT DE DISTRIBUCION		
		6DPK1200	SERPENTIN	C/AA	22808		MANG. INF.	C/AA	
		31100	TAPON DE ACEITE		22474		MANGUERA INF.	S/AA	
		31833	TAPON DE GASOLINA	SIN LLAVE REGULAR	CH-220731		MANGUERA SUP.	C/AA, S/AA	
		31781	TAPON DE GASOLINA	CON LLAVE REGULAR	38018		POLEA		
		31529	TAPON DE RADIADOR	(22 lbs) Sin Palanca	37013P		POLEA DECOPLADORA		
		38148	SENSOR MICRO-V	SERPENTIN - C/banda v de dc	6DPK1200		SERPENTIN	C/AA	
		33923	TERMOSTATO	195°F	31100		TAPON DE ACEITE		
4 CIL, 1.9 L DIESEL	2002	T321	BANDA ARBOL DE LEVAS		31781		TAPON DE GASOLINA	CON LLAVE REGULAR	
		TCK321	KIT DE DISTRIBUCION		31833		TAPON DE GASOLINA	SIN LLAVE REGULAR	
		22566	MANGUERA INF.		31529		TAPON DE RADIADOR	(22 lbs) Sin Palanca	
		22884	MANGUERA SUP.	RADIADOR A T"	T43010		SENSOR ARBOL DE LEVAS		
		22880	MANGUERA SUP.	"T" A TERMOSTATO	38148		SENSOR MICRO-V	SERPENTIN - C/banda v de dc	
		37013P	POLEA	DECOPLADORA ALTERNADC	33923		TERMOSTATO	195°F	
		37010P	POLEA	DECOPLADORA ALTERNADCV-6, 2.8 L	19661	2001	CALEF. A "T"-2		
		K060653	SERPENTIN		7DPK1363		SERPENTIN	C/AA	
		31100	TAPON DE ACEITE		31100		TAPON DE ACEITE		
		31833	TAPON DE GASOLINA		31781		TAPON DE GASOLINA	CON LLAVE REGULAR	
		31781	TAPON DE GASOLINA	CON LLAVE	31833		TAPON DE GASOLINA	SIN LLAVE REGULAR	
		31529	TAPON DE RADIADOR		31529		TAPON DE RADIADOR	(22 lbs) Sin Palanca	
		38192	SENSOR MICRO-V		38175		SENSOR MICRO-V		
		33209	TERMOSTATO	190°F	33209		TERMOSTATO	195°F	
4 CIL, 2.0 L	2002	T296	BANDA ARBOL DE LEVAS		60401	2000	EDH	PRESION	
		60401	EDH	PRESION	CH-220054		MANGUERA DE CALEF.	C/AA, S/AA	
		TCK296	KIT DE DISTRIBUCION		CH-220034		MANGUERA DE CALEF.	C/AA, S/AA	
		22808	MANG. INF.	C/TRANS MANUAL	CH-220064		MANGUERA DE CALEF.	C/AA	
		22875	MANG. SUP.	RAD A T"	CH-220663		MANGUERA DE PASO	C/AA	
		22876	MANG. SUP.	T" A MOTOR"	CH-220593		MANGUERA DE PASO	C/AA	
		37013P	POLEA DECOPLADORA		CH-220083		MANGUERA DE PASO	C/AA	
		6DPK1200	SERPENTIN	C/AA	CH-220073		MANGUERA DE PASO	C/AA	
		31100	TAPON DE ACEITE		CH-220333		MANGUERA DE PASO	C/AA	
		31781	TAPON DE GASOLINA	CON LLAVE REGULAR	CH-228182		MANGUERA INF.	C/AA	
		31833	TAPON DE GASOLINA	SIN LLAVE REGULAR	12T150		MANGUERA INF. FLEXIBLE	C/AA	
		31529	TAPON DE RADIADOR	(22 lbs) Sin Palanca	CH-228181		MANGUERA SUP.	C/AA	
		T43010	SENSOR ARBOL DE LEVAS		12T232		MANGUERA SUP. FLEXIBLE	C/AA	
		38148	SENSOR MICRO-V	SERPENTIN - C/banda v de dc	38018		POLEA		
		33923	TERMOSTATO	195°F	37013P		POLEA DECOPLADORA		
V-6, 2.8 L	2002	7DPK1363	SERPENTIN	C/AA	6DPK1200		SERPENTIN	C/AA	
		K060739	SERPENTIN	S/AA	31100		TAPON DE ACEITE		
		31100	TAPON DE ACEITE		31781		TAPON DE GASOLINA	CON LLAVE REGULAR	
		31833	TAPON DE GASOLINA	SIN LLAVE REGULAR	31833		TAPON DE GASOLINA	SIN LLAVE REGULAR	
		31781	TAPON DE GASOLINA	CON LLAVE REGULAR	31529		TAPON DE RADIADOR	(22 lbs) Sin Palanca	
		31529	TAPON DE RADIADOR	(22 lbs) Sin Palanca	38148		SENSOR MICRO-V	SERPENTIN - C/banda v de dc	
		38175	SENSOR MICRO-V		33923		TERMOSTATO	195°F	
4 CIL, 1.8 L	2001	T306	BANDA ARBOL DE LEVAS		T321	4 CIL, 1.9 L DIESEL	BANDA ARBOL DE LEVAS		
		60401	EDH	PRESION	TCK321		KIT DE DISTRIBUCION		
		22808	MANG. INF.	C/TRANS MANUAL	22566		MANGUERA INF.		
		22879	MANG. SUP.	RAD A T"	21534		MANGUERA SUP.	RADIADOR A T"	
		22880	MANG. SUP.	T" A MOTOR"	21531		MANGUERA SUP.	"T" A TERMOSTATO	
		38018	POLEA		37013P		POLEA	DECOPLADORA ALTERNADC	
		37013P	POLEA DECOPLADORA		37010P		POLEA	DECOPLADORA ALTERNADC	
		6DPK1200	SERPENTIN	C/AA	K060653		SERPENTIN	CON A.A.	
		31100	TAPON DE ACEITE		K060355		SERPENTIN	SIN A.A.	
		31833	TAPON DE GASOLINA	SIN LLAVE REGULAR	31100		TAPON DE ACEITE		
		31781	TAPON DE GASOLINA	CON LLAVE REGULAR	31833		TAPON DE GASOLINA		
		31529	TAPON DE RADIADOR	(22 lbs) Sin Palanca	31781		TAPON DE GASOLINA	CON LLAVE	
		38148	SENSOR MICRO-V	SERPENTIN - C/banda v de dc	31529		TAPON DE RADIADOR		
		33923	TERMOSTATO	195°F	38192		SENSOR MICRO-V		
4 CIL, 1.9 L DIESEL	2001	T321	BANDA ARBOL DE LEVAS	{141 D x 25 mm}	33209		TERMOSTATO	190°F	
		TCK321	KIT DE DISTRIBUCION		K060455	2000	ALT & A.A.	S/Micro-V doble	
		22566	MANGUERA INF.		K060385		ALT.	S/AA, S/DH	
		21531	MANGUERA SUP.	"T" A TERMOSTATO	K060441		ALT.	C/AA, C/DH	
		21534	MANGUERA SUP.	RADIADOR A T"	K060408		ALT.	S/AA, S/DH	
		37010P	POLEA	DECOPLADORA ALTERNADC	K060454		ALT.	C/AA, C/DH	
		37013P	POLEA	DECOPLADORA ALTERNADC	7295		BA Y D.H.	S/Micro-V doble	

    				    				
4 CIL, 2.0 L	2000	T296	BANDA ARBOL DE LEVAS			22876	MANG. SUP.	T* A MOTOR*
		T262	BANDA ARBOL DE LEVAS	S/AA, S/DH		22278	MANGUERA INF.	C/AA
		T262	BANDA ARBOL DE LEVAS	C/AA, C/DH		22474	MANGUERA INF.	S/AA
		7306 GS	D.H.	C/AA, C/DH		CH-220731	MANGUERA SUP.	C/AA, S/AA
		60401	EDH	PRESION		38087	POLEA	ALT. Y A.A.
		TCK262	KIT DE DISTRIBUCION			38018	POLEA	
		TCK296	KIT DE DISTRIBUCION			37013P	POLEA DECOPLADORA	
		22808	MANG. INF.	C/AA		31100	TAPON DE ACEITE	
		22876	MANG. SUP.	T* A MOTOR*		31833	TAPON DE GASOLINA	SIN LLAVE REGULAR
		22875	MANG. SUP.	RAD A T*		31781	TAPON DE GASOLINA	CON LLAVE REGULAR
		22278	MANGUERA INF.	C/AA		31529	TAPON DE RADIADOR	(22 lbs) Sin Palanca
		22474	MANGUERA INF.	S/AA		31328	TAPON DE RADIADOR	(20 lbs) Sin palanca
		CH-220731	MANGUERA SUP.	C/AA, S/AA		T43010	SENSOR ARBOL DE LEVAS	
		38018	POLEA			T41079	SENSOR ARBOL DE LEVAS	
		38087	POLEA	ALT. Y A.A.		38147	SENSOR MICRO-V	ALT. Y A.A.
		37013P	POLEA DECOPLADORA			38148	SENSOR MICRO-V	SERPENTIN- C/BANDA DE DC
		6DPK1200	SERPENTIN	C/AA C/BANDA DE DOBLE PE		33208	TERMOSTATO	180°F
		31100	TAPON DE ACEITE			340J2	VENTILADOR	S/AA, S/DH
		31781	TAPON DE GASOLINA	CON LLAVE REGULAR		340J2	VENTILADOR	S/AA, S/DH
		31833	TAPON DE GASOLINA	SIN LLAVE REGULAR		340J2	VENTILADOR	C/AA, C/DH
31529	TAPON DE RADIADOR	(22 lbs) Sin Palanca	V-6, 2.8 L	1999	K060739	ALT.		
T41079	SENSOR ARBOL DE LEVAS			T297	BANDA ARBOL DE LEVAS	C/AA, C/DH		
T43010	SENSOR ARBOL DE LEVAS			19661	CALEF. A "T"-2			
38147	SENSOR MICRO-V	ALT. Y A.A.		22598	MANG. SUP.	C/TRANS MANUAL		
38148	SENSOR MICRO-V	SERPENTIN - C/banda v de dc		22603	MANGUERA INF.	C/Trans manual		
340J2	VENTILADOR	C/AA, C/DH		7DPK1363	SERPENTIN	C/BANDA DE DOBLE PERFIL.		
340J2	VENTILADOR	S/AA, S/DH		31100	TAPON DE ACEITE			
340J2	VENTILADOR	S/AA, S/DH		31781	TAPON DE GASOLINA	CON LLAVE REGULAR		
V-6, 2.8 L	2000	K060739	ALT.	C/AA, C/DH		31833	TAPON DE GASOLINA	SIN LLAVE REGULAR
		T297	BANDA ARBOL DE LEVAS	C/AA, C/DH		31529	TAPON DE RADIADOR	(22 lbs) Sin Palanca
		19661	CALEF. A "T"-2			38175	SENSOR MICRO-V	
		7DPK1363	SERPENTIN	C/AA		33078	TERMOSTATO	180°F
		31100	TAPON DE ACEITE		4 CIL, 1.8 L	1998	K060454	ALT.
		31833	TAPON DE GASOLINA	SIN LLAVE REGULAR		K060355	ALT.	C/AA, C/DH
		31781	TAPON DE GASOLINA	CON LLAVE REGULAR		T260	BANDA ARBOL DE LEVAS	C/AA, C/DH
		31529	TAPON DE RADIADOR	(22 lbs) Sin Palanca		7306 GS	D.H.	C/AA, C/DH
		38175	SENSOR MICRO-V			7277 GS	D.H.	S/AA, C/DH
		33078	TERMOSTATO	180°F		CH-220034	MANGUERA DE CALEF.	C/AA
		K060355	ALT.	S/AA, C/DH		CH-220064	MANGUERA DE CALEF.	C/AA
		K060454	ALT.	C/AA, C/DH		CH-220054	MANGUERA DE CALEF.	C/AA, S/AA
T260	BANDA ARBOL DE LEVAS	C/AA, C/DH		CH-220663	MANGUERA DE PASO	C/AA		
7306 GS	D.H.	C/AA, C/DH		CH-220073	MANGUERA DE PASO	C/AA		
7277 GS	D.H.	S/AA, C/DH		CH-220333	MANGUERA DE PASO	C/AA		
CH-220034	MANGUERA DE CALEF.	C/AA		CH-220083	MANGUERA DE PASO	C/AA		
CH-220054	MANGUERA DE CALEF.	C/AA		CH-220593	MANGUERA DE PASO	C/AA		
CH-220064	MANGUERA DE CALEF.	C/AA		CH-228182	MANGUERA INF.	C/AA		
CH-220333	MANGUERA DE PASO	C/AA		12T150	MANGUERA INF. FLEXIBLE	C/AA		
CH-220663	MANGUERA DE PASO	C/AA		CH-228181	MANGUERA SUP.	C/AA		
CH-220083	MANGUERA DE PASO	C/AA		12T232	MANGUERA SUP. FLEXIBLE	C/AA		
CH-220593	MANGUERA DE PASO	C/AA		31100	TAPON DE ACEITE			
CH-220073	MANGUERA DE PASO	C/AA		31833	TAPON DE GASOLINA	SIN LLAVE REGULAR		
CH-228182	MANGUERA INF.	C/AA, S/AA		31781	TAPON DE GASOLINA	CON LLAVE REGULAR		
12T150	MANGUERA INF. FLEXIBLE	C/AA		31328	TAPON DE RADIADOR	(20 lbs) Sin palanca		
CH-228181	MANGUERA SUP.	C/AA		4 CIL, 2.0 L	1998	K060454	ALT.	
12T232	MANGUERA SUP. FLEXIBLE	C/AA		K060408	ALT.	S/AA, S/DH		
31100	TAPON DE ACEITE			T262	BANDA ARBOL DE LEVAS	C/AA, C/DH		
31833	TAPON DE GASOLINA	SIN LLAVE REGULAR		7306 GS	D.H.	C/AA, C/DH		
31781	TAPON DE GASOLINA	CON LLAVE REGULAR		92030	EDH	PRESION		
31328	TAPON DE RADIADOR	(20 lbs) Sin palanca		TCK262	KIT DE DISTRIBUCION			
31529	TAPON DE RADIADOR	(22 lbs) Sin Palanca		22279	MANGUERA INF.	C/AA		
4 CIL, 1.8 L	1999	K060455	ALT & A.A.	S/Micro-V doble		CH-220721	MANGUERA SUP.	
		K060408	ALT.	S/AA, S/DH		CH-220731	MANGUERA SUP.	
		K060454	ALT.	C/AA, C/DH		38087	POLEA	ALT.
		K060441	ALT.	C/AA, C/DH		31100	TAPON DE ACEITE	
		K060385	ALT.	S/AA, S/DH		31833	TAPON DE GASOLINA	SIN LLAVE REGULAR
		7295	BA Y D.H.	S/Micro-V doble		31781	TAPON DE GASOLINA	CON LLAVE REGULAR
		T296	BANDA ARBOL DE LEVAS			31328	TAPON DE RADIADOR	(20 lbs) Sin palanca
		T262	BANDA ARBOL DE LEVAS	C/AA, C/DH		T41079	SENSOR ARBOL DE LEVAS	
		T262	BANDA ARBOL DE LEVAS	S/AA, S/DH		38147	SENSOR MICRO-V	
		7306 GS	D.H.	C/AA, C/DH		33209	TERMOSTATO	195°F
		92030	EDH	PRESION		340J2	VENTILADOR	S/AA, S/DH
		TCK296	KIT DE DISTRIBUCION			340J2	VENTILADOR	C/AA, C/DH
TCK262	KIT DE DISTRIBUCION		V-6, 2.8 L	1998	K060739	ALT.		
22808	MANG. INF.	C/AA		T297	BANDA ARBOL DE LEVAS	C/AA, C/DH		
22875	MANG. SUP.	RAD A T*		K070535	SERPENTIN			
4 CIL, 2.0 L	1999	K060455	ALT & A.A.	S/Micro-V doble		CH-220721	MANGUERA SUP.	
		K060408	ALT.	S/AA, S/DH		CH-220731	MANGUERA SUP.	
		K060454	ALT.	C/AA, C/DH		38087	POLEA	ALT.
		K060441	ALT.	C/AA, C/DH		31100	TAPON DE ACEITE	
		K060385	ALT.	S/AA, S/DH		31833	TAPON DE GASOLINA	SIN LLAVE REGULAR
		7295	BA Y D.H.	S/Micro-V doble		31781	TAPON DE GASOLINA	CON LLAVE REGULAR
		T296	BANDA ARBOL DE LEVAS			31328	TAPON DE RADIADOR	(20 lbs) Sin palanca
		T262	BANDA ARBOL DE LEVAS	C/AA, C/DH		T41079	SENSOR ARBOL DE LEVAS	
		T262	BANDA ARBOL DE LEVAS	S/AA, S/DH		38147	SENSOR MICRO-V	
		7306 GS	D.H.	C/AA, C/DH		33209	TERMOSTATO	195°F
		92030	EDH	PRESION		340J2	VENTILADOR	S/AA, S/DH
		TCK296	KIT DE DISTRIBUCION			340J2	VENTILADOR	C/AA, C/DH
TCK262	KIT DE DISTRIBUCION		V-6, 2.8 L	1998	K060739	ALT.		
22808	MANG. INF.	C/AA		T297	BANDA ARBOL DE LEVAS	C/AA, C/DH		
22875	MANG. SUP.	RAD A T*		K070535	SERPENTIN			

VOLKSWAGEN		GATES		VOLKSWAGEN		GATES		
VOLKSWAGEN		GATES		VOLKSWAGEN		GATES		
V-6, 2.8 L	1998	K070505	SERPENTIN			TPG-23001	TENSOR ARBOL DE LEVAS	
		31100	TAPON DE ACEITE			TMV-23001	TENSOR MICRO-V	
		31833	TAPON DE GASOLINA	SIN LLAVE REGULAR	4 CIL, 1.6 L	2005	T1548	BANDA ARBOL DE LEVAS
		31781	TAPON DE GASOLINA	CON LLAVE REGULAR			TCK1548	KIT DE DISTRIBUCION
		31328	TAPON DE RADIADOR	(20 lbs) Sin palanca			K060669	SERPENTIN
		38175	TENSOR MICRO-V				K060420	SERPENTIN
4 CIL, 1.8 L	1997	K060454	ALT.	C/AA, C/DH			TPG-23001	TENSOR ARBOL DE LEVAS
		K060355	ALT.	S/AA, C/DH			TMV-23001	TENSOR MICRO-V
		T260	BANDA ARBOL DE LEVAS	C/AA, C/DH	4 CIL, 1.6 L	2004	T1548	BANDA ARBOL DE LEVAS
		BDH-5128	BOMBA DE DIR. HIDR.				TCK1548	KIT DE DISTRIBUCION
		7277 GS	D.H.	S/AA, C/DH			K060669	SERPENTIN
		7306 GS	D.H.	C/AA, C/DH			K060420	SERPENTIN
		CH-220034	MANGUERA DE CALEF.	C/AA			TPG-23001	TENSOR ARBOL DE LEVAS
		CH-220054	MANGUERA DE CALEF.	C/AA			TMV-23001	TENSOR MICRO-V
		CH-220064	MANGUERA DE CALEF.	C/AA			TPG-23001	TENSOR ARBOL DE LEVAS
		CH-220663	MANGUERA DE PASO	C/AA			TMV-23001	TENSOR MICRO-V
		CH-220593	MANGUERA DE PASO	C/AA				
		CH-220073	MANGUERA DE PASO	C/AA				
		CH-220083	MANGUERA DE PASO	C/AA				
		CH-220333	MANGUERA DE PASO	C/AA				
		CH-228182	MANGUERA INF.	C/AA				
		12T150	MANGUERA INF. FLEXIBLE	C/AA				
		CH-228181	MANGUERA SUP.	C/AA				
		12T232	MANGUERA SUP. FLEXIBLE	C/AA				
		31100	TAPON DE ACEITE					
		31781	TAPON DE GASOLINA	CON LLAVE REGULAR	4 CIL, 1.8 L	2001	K060365	ALT.
		31833	TAPON DE GASOLINA	SIN LLAVE REGULAR			T260	BANDA ARBOL DE LEVAS
		31328	TAPON DE RADIADOR	(20 lbs) Sin palanca			CH-220593	MANGUERA DE PASO
4 CIL, 2.0 L	1997	K060454	ALT.	C/AA, C/DH			CH-227182	MANGUERA INF.
		K060408	ALT.	S/AA, S/DH			CH-227181	MANGUERA SUP.
		T262	BANDA ARBOL DE LEVAS	C/AA, C/DH			31100	TAPON DE ACEITE
		BDH-5128	BOMBA DE DIR. HIDR.				TMV-22001	TENSOR MICRO-V
		7306 GS	D.H.	C/AA, C/DH			TMV-22002	TENSOR MICRO-V
		92030	EDH	PRESION	4 CIL, 1.8 L	2000	K060365	ALT.
		TCK262	KIT DE DISTRIBUCION				T260	BANDA ARBOL DE LEVAS
		CH-228182	MANGUERA INF.	C/AA			CH-220593	MANGUERA DE PASO
		CH-220551	MANGUERA SUP.	C/AA			CH-227182	MANGUERA INF.
		38087	POLEA	ALT.			CH-227181	MANGUERA SUP.
		31100	TAPON DE ACEITE				31100	TAPON DE ACEITE
		31781	TAPON DE GASOLINA	CON LLAVE REGULAR			TMV-22002	TENSOR MICRO-V
		31833	TAPON DE GASOLINA	SIN LLAVE REGULAR	4 CIL, 1.8 L	1999	TMV-22001	TENSOR MICRO-V
		31328	TAPON DE RADIADOR	(20 lbs) Sin palanca			K060365	ALT.
		T41079	TENSOR ARBOL DE LEVAS				T260	BANDA ARBOL DE LEVAS
		38147	TENSOR MICRO-V				CH-220593	MANGUERA DE PASO
		33209	TERMOSTATO	195°F			CH-227182	MANGUERA INF.
		340J2	VENTILADOR	S/AA, S/DH			CH-227181	MANGUERA SUP.
		340J2	VENTILADOR	C/AA, C/DH			31100	TAPON DE ACEITE
V-6, 2.8 L	1997	T297	BANDA ARBOL DE LEVAS				TMV-22001	TENSOR MICRO-V
		BDH-5128	BOMBA DE DIR. HIDR.				TMV-22002	TENSOR MICRO-V
		K070535	SERPENTIN				K060365	ALT.
		K070505	SERPENTIN				T260	BANDA ARBOL DE LEVAS
		31100	TAPON DE ACEITE				CH-220593	MANGUERA DE PASO
		31833	TAPON DE GASOLINA	SIN LLAVE REGULAR	4 CIL, 1.8 L	1997	CH-227182	MANGUERA INF.
		31781	TAPON DE GASOLINA	CON LLAVE REGULAR			CH-227181	MANGUERA SUP.
		31328	TAPON DE RADIADOR	(20 lbs) Sin palanca			31100	TAPON DE ACEITE
		38175	TENSOR MICRO-V				TMV-22001	TENSOR MICRO-V











## PANEL

4 CIL, 1.8 L	2001	K060365	ALT.	C/RAD
		T260	BANDA ARBOL DE LEVAS	C/RAD
		CH-220593	MANGUERA DE PASO	C/RAD
		CH-227182	MANGUERA INF.	C/RAD
		CH-227181	MANGUERA SUP.	C/RAD
		31100	TAPON DE ACEITE	
		TMV-22001	TENSOR MICRO-V	C/AA, C/DH
		TMV-22002	TENSOR MICRO-V	S/AA, C/DH
4 CIL, 1.8 L	2000	K060365	ALT.	C/RAD
		T260	BANDA ARBOL DE LEVAS	C/RAD
		CH-220593	MANGUERA DE PASO	C/RAD
		CH-227182	MANGUERA INF.	C/RAD
		CH-227181	MANGUERA SUP.	C/RAD
		31100	TAPON DE ACEITE	
		TMV-22002	TENSOR MICRO-V	S/AA, C/DH
		TMV-22001	TENSOR MICRO-V	C/AA, C/DH
4 CIL, 1.8 L	1999	K060365	ALT.	C/RAD
		T260	BANDA ARBOL DE LEVAS	C/RAD
		CH-220593	MANGUERA DE PASO	C/RAD
		CH-227182	MANGUERA INF.	C/RAD
		CH-227181	MANGUERA SUP.	C/RAD
		31100	TAPON DE ACEITE	
		TMV-22002	TENSOR MICRO-V	S/AA, C/DH
		TMV-22001	TENSOR MICRO-V	C/AA, C/DH
4 CIL, 1.8 L	1998	K060365	ALT.	C/RAD
		T260	BANDA ARBOL DE LEVAS	C/RAD
		CH-220593	MANGUERA DE PASO	C/RAD
		CH-227182	MANGUERA INF.	C/RAD
		CH-227181	MANGUERA SUP.	C/RAD
		31100	TAPON DE ACEITE	
		TMV-22002	TENSOR MICRO-V	S/AA, C/DH
		TMV-22001	TENSOR MICRO-V	C/AA, C/DH
4 CIL, 1.8 L	1997	K060365	ALT.	C/RAD
		T260	BANDA ARBOL DE LEVAS	C/RAD
		CH-220593	MANGUERA DE PASO	C/RAD
		CH-227182	MANGUERA INF.	C/RAD
		CH-227181	MANGUERA SUP.	C/RAD
		31100	TAPON DE ACEITE	
		TMV-22001	TENSOR MICRO-V	C/AA, C/DH
		TMV-22002	TENSOR MICRO-V	S/AA, C/DH











## LUPO

4 CIL, 1.6 L	2008	T1548	BANDA ARBOL DE LEVAS		4 CIL, 2.0 L TSI	2010	K060439	SERPENTIN
		TCK1548	KIT DE DISTRIBUCION		4 CIL, 2.0 L TSI	2009	K060439	SERPENTIN
		K060420	SERPENTIN	SIN A.A.	4 CIL, 2.0 L	2008	T334	BANDA ARBOL DE LEVAS
		K060669	SERPENTIN	CON A.A.			38018	POLEA
		TPG-23001	TENSOR ARBOL DE LEVAS		V-6, 3.6 L	2008	K060415	SERPENTIN
		TMV-23001	TENSOR MICRO-V				31529	TAPON DE RADIADOR
4 CIL, 1.6 L	2007	T1548	BANDA ARBOL DE LEVAS				K060637	SERPENTIN
		TCK1548	KIT DE DISTRIBUCION		4 CIL, 2.0 L	2007	31100	TAPON DE ACEITE
		K060669	SERPENTIN	CON A.A.			31529	TAPON DE RADIADOR
		K060420	SERPENTIN	SIN A.A.			T334	BANDA ARBOL DE LEVAS
		TPG-23001	TENSOR ARBOL DE LEVAS				38018	POLEA
		TMV-23001	TENSOR MICRO-V				K060415	SERPENTIN
4 CIL, 1.6 L	2006	T1548	BANDA ARBOL DE LEVAS		V-6, 3.6 L	2007	31529	TAPON DE RADIADOR
		TCK1548	KIT DE DISTRIBUCION				K060637	SERPENTIN
		K060669	SERPENTIN	CON A.A.			31100	TAPON DE ACEITE
		K060420	SERPENTIN	SIN A.A.	4 CIL, 2.0 L	2006	31529	TAPON DE RADIADOR
							T334	BANDA ARBOL DE LEVAS
							38018	POLEA











## PASSAT

									
4 CIL, 2.0 L	2006	K060415 38148	SERPENTIN TENSOR MICRO-V				31529 38193	TAPON DE RADIADOR TENSOR MICRO-V	(22 lbs) Sin Palanca
V-6, 3.6 L	2006	K060637 31100	SERPENTIN TAPON DE ACEITE		4 CIL, 1.8 L	2001	K040338 T291	A.A. BANDA ARBOL DE LEVAS	
4 CIL, 1.8 L	2005	T306 38068 K050510 K040338 31100 31781 31833 31529 38151 33923	BANDA ARBOL DE LEVAS POLEA SERPENTIN SERPENTIN TAPON DE ACEITE TAPON DE GASOLINA TAPON DE GASOLINA TAPON DE RADIADOR TENSOR MICRO-V TERMOSTATO	LOCA   CON LLAVE REGULAR SIN LLAVE REGULAR (22 lbs) Sin Palanca  195°F			T317 19793 7208 38068 31100 31833 31781 31529 38151 33923 K050510	BANDA ARBOL DE LEVAS CALEF. A TUBO-1 D.H. POLEA TAPON DE ACEITE TAPON DE GASOLINA TAPON DE GASOLINA TAPON DE RADIADOR TENSOR MICRO-V TERMOSTATO VENT, ALT Y D.H.	A.A.  SIN LLAVE REGULAR CON LLAVE REGULAR (22 lbs) Sin Palanca  195°F
V-6, 2.8 L	2005	T297 K060739 31100 31781 31833 31529 38193 33923	BANDA ARBOL DE LEVAS SERPENTIN TAPON DE ACEITE TAPON DE GASOLINA TAPON DE GASOLINA TAPON DE RADIADOR TENSOR MICRO-V TERMOSTATO	  CON LLAVE REGULAR SIN LLAVE REGULAR (22 lbs) Sin Palanca  195°F	V-6, 2.8 L	2001	T297 19790 K060739 31100 31833 31781 31529 38193 33069 K040338 K050510	BANDA ARBOL DE LEVAS CALEF. A TUBO-1 SERPENTIN TAPON DE ACEITE TAPON DE GASOLINA TAPON DE GASOLINA TAPON DE RADIADOR TENSOR MICRO-V TERMOSTATO A.A.	SIN LLAVE REGULAR CON LLAVE REGULAR (22 lbs) Sin Palanca  195°F C/DH C/AA,C/DH
4 CIL, 1.8 L	2004	T306 38068 K050510 K040335 31100 31833 31529 38151 33923	BANDA ARBOL DE LEVAS POLEA SERPENTIN SERPENTIN TAPON DE ACEITE TAPON DE GASOLINA TAPON DE RADIADOR TENSOR MICRO-V TERMOSTATO	A.A. VENT Y DIR. HIDR A.A.  SIN LLAVE REGULAR (22 lbs) Sin Palanca  195°F	4 CIL, 1.8 L	2000	K040338 K050510 T291 T317 19793 7208 38068 31100 31833 31781 31529 38151 33923	A.A. ALT. BANDA ARBOL DE LEVAS BANDA ARBOL DE LEVAS CALEF. A TUBO-1 D.H. POLEA TAPON DE ACEITE TAPON DE GASOLINA TAPON DE GASOLINA TAPON DE RADIADOR TENSOR MICRO-V TERMOSTATO	C/DH C/AA,C/DH  C/AA,C/DH A.A.
V-6, 2.8 L	2004	T297 K060739 31100 31781 31833 31529 38193 33079	BANDA ARBOL DE LEVAS SERPENTIN TAPON DE ACEITE TAPON DE GASOLINA TAPON DE GASOLINA TAPON DE RADIADOR TENSOR MICRO-V TERMOSTATO	  CON LLAVE REGULAR SIN LLAVE REGULAR (22 lbs) Sin Palanca  195°F	V-6, 2.8 L	2000	T297 19790 K060739 31100 31833 31781 31529 38151 33923	BANDA ARBOL DE LEVAS CALEF. A TUBO-1 SERPENTIN TAPON DE ACEITE TAPON DE GASOLINA TAPON DE GASOLINA TAPON DE RADIADOR TENSOR MICRO-V TERMOSTATO	SIN LLAVE REGULAR CON LLAVE REGULAR (22 lbs) Sin Palanca  195°F
4 CIL, 1.8 L	2003	K040338 T291 T317 19793 7208 38068 K040335 31100 31833 31529 38151 33923 K050510	A.A. BANDA ARBOL DE LEVAS BANDA ARBOL DE LEVAS CALEF. A TUBO-1 D.H. POLEA SERPENTIN TAPON DE ACEITE TAPON DE GASOLINA TAPON DE RADIADOR TENSOR MICRO-V TERMOSTATO VENT, ALT Y D.H.	     A.A. ALTERNADOR  SIN LLAVE REGULAR (22 lbs) Sin Palanca  195°F	4 CIL, 1.8 L	1999	T297 19790 K060739 31100 31833 31781 31529 38193 33069 K040338 K050510 T317 T291 19793 7208 38068 31100 31781 31833 31529 38151 33923	A.A. BANDA ARBOL DE LEVAS BANDA ARBOL DE LEVAS CALEF. A TUBO-1 D.H. POLEA TAPON DE ACEITE TAPON DE GASOLINA TAPON DE GASOLINA TAPON DE RADIADOR TENSOR MICRO-V TERMOSTATO A.A. ALT. BANDA ARBOL DE LEVAS BANDA ARBOL DE LEVAS CALEF. A TUBO-1 D.H.	C/DH C/AA,C/DH  C/AA,C/DH A.A.
V-6, 2.8 L	2003	T297 K060739 31100 31833 31529 38193	BANDA ARBOL DE LEVAS SERPENTIN TAPON DE ACEITE TAPON DE GASOLINA TAPON DE RADIADOR TENSOR MICRO-V	ALTERNADOR  SIN LLAVE REGULAR (22 lbs) Sin Palanca			38068 31100 31781 31833 31529 38151 33923	POLEA TAPON DE ACEITE TAPON DE GASOLINA TAPON DE GASOLINA TAPON DE RADIADOR TENSOR MICRO-V TERMOSTATO	C/AA,C/DH A.A.
4 CIL, 1.8 L	2002	K040338 T291 T317 19793 7208 38068 31100 31781 31833 31529 38151 33923 K050510	A.A. BANDA ARBOL DE LEVAS BANDA ARBOL DE LEVAS CALEF. A TUBO-1 D.H. POLEA TAPON DE ACEITE TAPON DE GASOLINA TAPON DE GASOLINA TAPON DE RADIADOR TENSOR MICRO-V TERMOSTATO VENT, ALT Y D.H.	     A.A.  CON LLAVE REGULAR SIN LLAVE REGULAR (22 lbs) Sin Palanca  195°F	V-6, 2.8 L	1999	T297 19790 22603 K060739 31100 31781 31833 31529 38193 33069 T297 K060739	BANDA ARBOL DE LEVAS CALEF. A TUBO-1 MANGUERA INF. SERPENTIN TAPON DE ACEITE TAPON DE GASOLINA TAPON DE GASOLINA TAPON DE RADIADOR TENSOR MICRO-V TERMOSTATO BANDA ARBOL DE LEVAS SERPENTIN	195°F C/Trans manual
V-6, 2.8 L	2002	K060739 31100 31781 31833	SERPENTIN TAPON DE ACEITE TAPON DE GASOLINA TAPON DE GASOLINA	SIN LLAVE REGULAR CON LLAVE REGULAR (22 lbs) Sin Palanca	V-6, 2.8 L	1998	31100 31833 31781 31529	TAPON DE ACEITE TAPON DE GASOLINA TAPON DE GASOLINA TAPON DE RADIADOR	SIN LLAVE REGULAR CON LLAVE REGULAR (22 lbs) Sin Palanca



									
V-6, 2.8 L	1998	38193 33069	SENSOR MICRO-V TERMOSTATO	195°F				CH-220852 CH-220841	MANGUERA INF. MANGUERA SUP.
4 CIL, 1.8 L	1997	BDH-5128 31833 31781 31328	BOMBA DE DIR. HIDR. TAPON DE GASOLINA TAPON DE GASOLINA TAPON DE RADIADOR	SIN LLAVE REGULAR CON LLAVE REGULAR (20 lbs) Sin palanca				K060894 T41079	SERPENTIN SENSOR ARBOL DE LEVAS
4 CIL, 2.0 L	1997	BDH-5128 31833 31781 31328	BOMBA DE DIR. HIDR. TAPON DE GASOLINA TAPON DE GASOLINA TAPON DE RADIADOR	SIN LLAVE REGULAR CON LLAVE REGULAR (20 lbs) Sin palanca	4 CIL, 2.0 L	2004		TMV-22002 TMV-22001 TH11287G1	TENSOR MICRO-V TENSOR MICRO-V TERMOSTATO
V-6, 2.8 L	1997	BDH-5128 31781 31833 31328 38175 33069	BOMBA DE DIR. HIDR. TAPON DE GASOLINA TAPON DE GASOLINA TAPON DE RADIADOR SENSOR MICRO-V TERMOSTATO	CON LLAVE REGULAR SIN LLAVE REGULAR (20 lbs) Sin palanca	4 CIL, 1.8 L	2003		T260 60402 K060894 TMV-22001 TMV-22002 TH11287G1	BANDA ARBOL DE LEVAS EDH SERPENTIN TENSOR MICRO-V TENSOR MICRO-V TERMOSTATO
<b>POINTER</b>									
4 CIL, 1.8 L	2008	7371 GS T260 CH-220852 CH-220841 K060683 K060894 T41079 TMV-22001 TMV-22002 TH11287G1	ALT. BANDA ARBOL DE LEVAS MANGUERA INF. MANGUERA SUP. SERPENTIN SERPENTIN TENSOR ARBOL DE LEVAS TENSOR MICRO-V TENSOR MICRO-V TERMOSTATO	SIN/AA, S/DH  SIN A.A. CON A.A.	4 CIL, 2.0 L	2003		T260 60402 K060894 TMV-22001 TMV-22002 TH11287G1	BANDA ARBOL DE LEVAS EDH SERPENTIN TENSOR MICRO-V TENSOR MICRO-V TERMOSTATO
4 CIL, 1.8 L	2007	7371 GS T260 CH-220852 CH-220841 K060683 K060894 T41079 TMV-22001 TMV-22002 TH11287G1	ALT. BANDA ARBOL DE LEVAS MANGUERA INF. MANGUERA SUP. SERPENTIN SERPENTIN TENSOR ARBOL DE LEVAS TENSOR MICRO-V TENSOR MICRO-V TERMOSTATO	SIN/AA, S/DH  SIN A.A. CON A.A.	4 CIL, 1.8 L	2002		T260 7371GS 60402 CH-220852 CH-220841 K060683 K060894 T41079 TMV-22001 TMV-22002 TH11287G1	BANDA ARBOL DE LEVAS BANDA V EDH MANG. INF. MANG. SUP. SERPENTIN SERPENTIN TENSOR ARBOL DE LEVAS TENSOR MICRO-V TENSOR MICRO-V TERMOSTATO
4 CIL, 1.8 L	2006	7371 GS T260 60402 CH-220852 CH-220841 K060683 K060894 T41079 TMV-22001 TMV-22002 TH11287G1	ALT. BANDA ARBOL DE LEVAS EDH MANGUERA INF. MANGUERA SUP. SERPENTIN SERPENTIN TENSOR ARBOL DE LEVAS TENSOR MICRO-V TENSOR MICRO-V TERMOSTATO	SIN/AA, S/DH  SIN A.A. CON A.A.	4 CIL, 2.0 L	2002		T260 60402 K060894 TMV-22001 TMV-22002 TH11287G1	BANDA ARBOL DE LEVAS EDH SERPENTIN TENSOR MICRO-V TENSOR MICRO-V TERMOSTATO
4 CIL, 2.0 L	2006	T260 60402 K060894 TMV-22002 TMV-22001 TH11287G1	BANDA ARBOL DE LEVAS EDH SERPENTIN TENSOR MICRO-V TENSOR MICRO-V TERMOSTATO	{121 D x 18.0 mm} PRESION CON A.A. S/AA, C/DH C/AA, C/DH 189°F	4 CIL, 1.8 L	2001		7371 GS T260 60402 CH-220523 CH-220423 CH-220532 12T172 CH-220371	ALT. BANDA ARBOL DE LEVAS EDH MANGUERA DE PASO MANGUERA DE PASO MANGUERA INF. MANGUERA INF. FLEXIBLE MANGUERA SUP.
4 CIL, 1.8 L	2005	K060683 7371GS T260 60402 CH-220852 CH-220841 K060894 T41079 TMV-22001 TMV-22002 TH11287G1	ALT. BANDA ALT. BANDA ARBOL DE LEVAS EDH MANGUERA INF. MANGUERA SUP. SERPENTIN SERPENTIN TENSOR ARBOL DE LEVAS TENSOR MICRO-V TENSOR MICRO-V TERMOSTATO	S/AA S/AA  PRESION	4 CIL, 2.0 L	2001		K060590 K060888 T41079 TMV-22002 TMV-22001 TH11287G1	SERPENTIN SERPENTIN TENSOR ARBOL DE LEVAS TENSOR MICRO-V TENSOR MICRO-V TERMOSTATO
4 CIL, 2.0 L	2005	T260 K060894 TMV-22002 TMV-22001 TH11287G1	BANDA ARBOL DE LEVAS SERPENTIN TENSOR MICRO-V TENSOR MICRO-V TERMOSTATO	C/AA S/AA, C/DH C/AA, C/DH 189°F	4 CIL, 1.8 L	2000		7371 GS T260 60402 CH-220423 CH-220523 CH-220532 12T172 CH-220371	ALT. BANDA ARBOL DE LEVAS EDH MANGUERA DE PASO MANGUERA DE PASO MANGUERA INF. MANGUERA INF. FLEXIBLE MANGUERA SUP.
4 CIL, 1.8 L	2004	K060683 T260 7374GS	ALT. BANDA ARBOL DE LEVAS BANDA V	S/AA S/AA Y S/DIR. HIDR.				K060590 K060888 31748 T41079	SERPENTIN SERPENTIN TAPON DE GASOLINA TENSOR ARBOL DE LEVAS



									
4 CIL, 1.8 L	2000	TMV-22002	TENSOR MICRO-V	S/AA, C/DH			K060888	SERPENTIN	C/AA, C/DH
		TMV-22001	TENSOR MICRO-V	C/AA, C/DH			K060590	SERPENTIN	S/AA, C/DH
		TH11287G1	TERMOSTATO	189°F			TMV-22001	TENSOR MICRO-V	C/AA, C/DH
4 CIL, 2.0 L	2000	TMV-22002	TENSOR MICRO-V	S/AA, C/DH			TMV-22002	TENSOR MICRO-V	S/AA, C/DH
4 CIL, 1.8 L	1999	7371 GS	ALT.	C/AA, C/DH	4 CIL, 1.8 L	2000	7371 GS	ALT.	S/AA, S/DH
		T260	BANDA ARBOL DE LEVAS	S/AA, S/DH			T260	BANDA ARBOL DE LEVAS	C/AA, C/DH
		CH-220523	MANGUERA DE PASO	S/AA, C/DH			CH-220523	MANGUERA DE PASO	S/AA, C/DH
		CH-220423	MANGUERA DE PASO	S/AA, C/DH			CH-220423	MANGUERA DE PASO	S/AA, C/DH
		CH-220532	MANGUERA INF.	S/AA, C/DH			CH-220532	MANGUERA INF.	S/AA, C/DH
		12T172	MANGUERA INF. FLEXIBLE	S/AA, C/DH			12T172	MANGUERA INF. FLEXIBLE	S/AA, C/DH
		CH-220371	MANGUERA SUP.	S/AA, C/DH			CH-220371	MANGUERA SUP.	S/AA, C/DH
		K060590	SERPENTIN	S/AA, C/DH			K060590	SERPENTIN	S/AA, C/DH
		K060888	SERPENTIN	C/AA, C/DH			K060888	SERPENTIN	C/AA, C/DH
		31748	TAPON DE GASOLINA	SIN LLAVE REGULAR			TMV-22002	TENSOR MICRO-V	S/AA, C/DH
		T41079	TENSOR ARBOL DE LEVAS	S/AA, C/DH			TMV-22001	TENSOR MICRO-V	C/AA, C/DH
4 CIL, 2.0 L	1999	TMV-22001	TENSOR MICRO-V	C/AA, C/DH	4 CIL, 1.8 L	1999	7371 GS	ALT.	S/AA, S/DH
		TMV-22002	TENSOR MICRO-V	S/AA, C/DH			T260	BANDA ARBOL DE LEVAS	C/AA, C/DH
		TMV-22001	TENSOR MICRO-V	S/AA, C/DH			CH-220523	MANGUERA DE PASO	S/AA, C/DH
		TMV-22002	TENSOR MICRO-V	S/AA, C/DH			CH-220423	MANGUERA DE PASO	S/AA, C/DH
4 CIL, 1.8 L	1998	7371 GS	ALT.	S/AA, S/DH			CH-220532	MANGUERA INF.	S/AA, C/DH
		T260	BANDA ARBOL DE LEVAS	S/AA, S/DH			12T172	MANGUERA INF. FLEXIBLE	S/AA, C/DH
		CH-220523	MANGUERA DE PASO	S/AA, C/DH			CH-220371	MANGUERA SUP.	S/AA, C/DH
		CH-220423	MANGUERA DE PASO	S/AA, C/DH			K060590	SERPENTIN	S/AA, C/DH
		CH-220532	MANGUERA INF.	S/AA, C/DH			K060888	SERPENTIN	C/AA, C/DH
		12T172	MANGUERA INF. FLEXIBLE	S/AA, C/DH			TMV-22002	TENSOR MICRO-V	S/AA, C/DH
		CH-220371	MANGUERA SUP.	S/AA, C/DH			TMV-22001	TENSOR MICRO-V	C/AA, C/DH
		31748	TAPON DE GASOLINA	SIN LLAVE REGULAR	4 CIL, 1.8 L	1998	7371GS	BANDA ALT.	S/AA, S/DH
		T41079	TENSOR ARBOL DE LEVAS	S/AA, C/DH			T260	BANDA ARBOL DE LEVAS	S/AA, C/DH
		TMV-22002	TENSOR MICRO-V	S/AA, C/DH			CH-220523	MANGUERA DE PASO	S/AA, C/DH
		TMV-22001	TENSOR MICRO-V	C/AA, C/DH			CH-220423	MANGUERA DE PASO	S/AA, C/DH
4 CIL, 2.0 L	1998	TMV-22001	TENSOR MICRO-V	C/AA, C/DH			CH-220532	MANGUERA INF.	S/AA, C/DH
		TMV-22002	TENSOR MICRO-V	S/AA, C/DH			12T172	MANGUERA INF. FLEXIBLE	S/AA, C/DH
							CH-220371	MANGUERA SUP.	S/AA, C/DH
							TMV-22001	TENSOR MICRO-V	C/AA, C/DH
							TMV-22002	TENSOR MICRO-V	S/AA, C/DH

### POINTER PICK-UP

4 CIL, 1.8 L	2005	7371GS	BANDA ALT.	S/AA, S/DH
		T260	BANDA ARBOL DE LEVAS	
		CH-220852	MANG. INF.	
		CH-220841	MANGUERA SUP.	
		K060895	SERPENTIN	S/AA
		K060685	SERPENTIN	C/AA, C/DH
		TMV-22001	TENSOR MICRO-V	S/AA, C/DH
		TMV-22002	TENSOR MICRO-V	S/AA, S/DH
4 CIL, 1.8 L	2004	7371GS	BANDA ALT.	S/AA, S/DH
		T260	BANDA ARBOL DE LEVAS	
		CH-220852	MANG. INF.	
		CH-220841	MANG. SUP.	
		K060685	SERPENTIN	S/AA
		K060895	SERPENTIN	C/AA
		TMV-22001	TENSOR MICRO-V	C/AA, C/DH
		TMV-22002	TENSOR MICRO-V	S/AA, C/DH
4 CIL, 1.8 L	2003	7371GS	BANDA ALT.	S/AA, S/DH
		T260	BANDA ARBOL DE LEVAS	
		CH-220852	MANG. INF.	
		CH-220841	MANG. SUP.	
		K060895	SERPENTIN	C/AA
		K060685	SERPENTIN	S/AA
		TMV-22001	TENSOR MICRO-V	C/AA, C/DH
		TMV-22002	TENSOR MICRO-V	S/AA, C/DH
4 CIL, 1.8 L	2002	7371GS	BANDA ALT.	S/AA, S/DH
		T260	BANDA ARBOL DE LEVAS	
		CH-220852	MANG. INF.	
		CH-220841	MANG. SUP.	
		K060685	SERPENTIN	S/AA
		K060895	SERPENTIN	C/AA
		TMV-22002	TENSOR MICRO-V	S/AA, C/DH
		TMV-22001	TENSOR MICRO-V	C/AA, C/DH
4 CIL, 1.8 L	2001	7371 GS	ALT.	S/AA, S/DH
		T260	BANDA ARBOL DE LEVAS	C/AA, C/DH
		CH-220523	MANGUERA DE PASO	S/AA, C/DH
		CH-220423	MANGUERA DE PASO	S/AA, C/DH
		CH-220532	MANGUERA INF.	S/AA, C/DH
		12T172	MANGUERA INF. FLEXIBLE	S/AA, C/DH
		CH-220371	MANGUERA SUP.	S/AA, C/DH

### POINTER STATION WAGON

4 CIL, 1.8 L	2001	T260	BANDA ARBOL DE LEVAS	C/AA, C/DH
		CH-220523	MANGUERA DE PASO	
		CH-220423	MANGUERA DE PASO	
		CH-220532	MANGUERA INF.	
		12T172	MANGUERA INF. FLEXIBLE	C/AA, S/AA C/DH
		CH-220371	MANGUERA SUP.	
		K060888	SERPENTIN	C/AA, C/DH
4 CIL, 1.8 L	2000	T260	BANDA ARBOL DE LEVAS	C/AA, C/DH
		CH-220523	MANGUERA DE PASO	
		CH-220423	MANGUERA DE PASO	
		CH-220532	MANGUERA INF.	
		12T172	MANGUERA INF. FLEXIBLE	C/AA, S/AA C/DH
		CH-220371	MANGUERA SUP.	
		K060888	SERPENTIN	C/AA, C/DH
		K060590	SERPENTIN	S/AA, C/DH
4 CIL, 1.8 L	1999	T260	BANDA ARBOL DE LEVAS	C/AA, C/DH
		CH-220423	MANGUERA DE PASO	
		CH-220523	MANGUERA DE PASO	
		CH-220532	MANGUERA INF.	
		12T172	MANGUERA INF. FLEXIBLE	C/AA, S/AA C/DH
		CH-220371	MANGUERA SUP.	
		K060888	SERPENTIN	C/AA, C/DH
		K060590	SERPENTIN	S/AA, C/DH
4 CIL, 1.8 L	1998	T260	BANDA ARBOL DE LEVAS	C/AA, C/DH
		CH-220523	MANGUERA DE PASO	
		CH-220423	MANGUERA DE PASO	
		CH-220532	MANGUERA INF.	
		12T172	MANGUERA INF. FLEXIBLE	C/AA, S/AA C/DH
		CH-220371	MANGUERA SUP.	

### POLO

4 CIL, 1.6 L	2007	T1548	BANDA ARBOL DE LEVAS	
		TCK1548	KIT DE DISTRIBUCION	
		CH-220782	MANGUERA INF.	
		CH-220871	MANGUERA SUP.	
		K060424	SERPENTIN	CON A.A.
		K060297	SERPENTIN	SIN A.A.

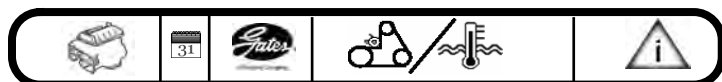

4 CIL, 1.6 L	2007	TPG-23001 TMV-23001	TENSOR ARBOL DE LEVAS TENSOR MICRO-V	
4 CIL, 1.6 L	2006	T1548 TCK1548 CH-220782 CH-220871 K060297 K060424 TPG-23001 TMV-23001	BANDA ARBOL DE LEVAS KIT DE DISTRIBUCION MANGUERA INF. MANGUERA SUP. SERPENTIN SERPENTIN TENSOR ARBOL DE LEVAS TENSOR MICRO-V	SIN A.A. CON A.A.
4 CIL, 1.6 L	2005	T1548 TCK1548 CH-220782 CH-220871 K060297 K060424 TPG-23001 TMV-23001	BANDA ARBOL DE LEVAS KIT DE DISTRIBUCION MANG. INF. MANG. SUP. SERPENTIN SERPENTIN TENSOR ARBOL DE LEVAS TENSOR MICRO-V	S/A/A C/A/A
4 CIL, 2.0 L	2005	T296 K060406	BANDA ARBOL DE LEVAS SERPENTIN	
4 CIL, 1.6 L	2004	T1548 CH-220782 CH-220871 K060297 K060424 TPG-23001 TMV-23001	BANDA ARBOL DE LEVAS MANG. INF. MANG. SUP. SERPENTIN SERPENTIN TENSOR ARBOL DE LEVAS TENSOR MICRO-V	C/A/A
4 CIL, 2.0 L	2004	T296 K060406	BANDA ARBOL DE LEVAS SERPENTIN	
4 CIL, 1.6 L	2003	T1548 CH-220782 CH-220871 K060424 K060297 TPG-23001 TMV-23001	BANDA ARBOL DE LEVAS MANG. INF. MANG. SUP. SERPENTIN SERPENTIN TENSOR ARBOL DE LEVAS TENSOR MICRO-V	C/A/A
4 CIL, 2.0 L	2003	T296 K060406	BANDA ARBOL DE LEVAS SERPENTIN	



4 CIL, 1.6 L	1997	7362 GS 8234 CH-221003 31100 10584 7362 GS 6362 GS 8234 CH-221003 31100 10584	ALT. ALT. MANGUERA DE PASO TAPON DE ACEITE TAPON DE GASOLINA ALT. ALT. ALT. MANGUERA DE PASO TAPON DE ACEITE TAPON DE GASOLINA	CON LLAVE REGULAR
--------------	------	---	--	-------------------

**SHARAN**

4 CIL, 1.8 L	2007	T306 6DPK1200 T43016 T43017 38148	BANDA ARBOL DE LEVAS SERPENTIN TENSOR ARBOL DE LEVAS TENSOR ARBOL DE LEVAS TENSOR MICRO-V	CON TORNILLO
4 CIL, 1.8 L	2006	T306 6DPK1200 T43016 T43017 38148	BANDA ARBOL DE LEVAS SERPENTIN TENSOR ARBOL DE LEVAS TENSOR ARBOL DE LEVAS TENSOR MICRO-V	CON TORNILLO
4 CIL, 1.8 L	2005	T306 6DPK1200 T43016 T43017 38148	BANDA ARBOL DE LEVAS SERPENTIN TENSOR ARBOL DE LEVAS TENSOR ARBOL DE LEVAS TENSOR MICRO-V	CON TORNILLO
4 CIL, 1.8 L	2004	T306 6DPK1200 T43017 T43016 38148	BANDA ARBOL DE LEVAS SERPENTIN TENSOR ARBOL DE LEVAS TENSOR ARBOL DE LEVAS TENSOR MICRO-V	CON TORNILLO
4 CIL, 1.8 L	2003	T306 6DPK1200 T43016 T43017 38148	BANDA ARBOL DE LEVAS SERPENTIN TENSOR ARBOL DE LEVAS TENSOR ARBOL DE LEVAS TENSOR MICRO-V	CON TORNILLO

**ROUTAN**

V-6, 3.8 L	2010	38018 36313 K060795 38323	POLEA POLEA DEL TENSOR SERPENTIN TENSOR	
V-6, 3.8 L	2009	38018 36313 K060795 38323	POLEA POLEA DEL TENSOR SERPENTIN TENSOR	

**SPORTVAN**

4 CIL, 1.6 L	2008	T1548 TCK1548 K060420 K060669 TMV-23001	BANDA ARBOL DE LEVAS KIT DE DISTRIBUCION SERPENTIN SERPENTIN TENSOR MICRO-V	SIN A.A. CON A.A.
4 CIL, 1.6 L	2007	T1548 TCK1548 K060420 K060669 TMV-23001	BANDA ARBOL DE LEVAS KIT DE DISTRIBUCION SERPENTIN SERPENTIN TENSOR MICRO-V	SIN A.A. CON A.A.
4 CIL, 1.6 L	2006	T1548 TCK1548 K060669 K060420 TMV-23001	BANDA ARBOL DE LEVAS KIT DE DISTRIBUCION SERPENTIN SERPENTIN TENSOR MICRO-V	CON A.A. SIN A.A.

**SAVEIRO**

4 CIL, 1.6 L	2010	T1548 TCK1548 TPG-23001	BANDA ARBOL DE LEVAS KIT DE DISTRIBUCION TENSOR	135 D X 19 MM
--------------	------	-------------------------------	---	---------------

**SEDAN**











4 CIL, 1.6 L	2001	6362 GS 7362 GS 8234 CH-221003 31100	ALT. ALT. ALT. MANGUERA DE PASO TAPON DE ACEITE	
4 CIL, 1.6 L	2000	6362 GS 7362 GS 8234 CH-221003 31100 10584	ALT. ALT. ALT. MANGUERA DE PASO TAPON DE ACEITE TAPON DE GASOLINA	CON LLAVE REGULAR
4 CIL, 1.6 L	1999	6362 GS 7362 GS 8234 CH-221003 31100 10584	ALT. ALT. ALT. MANGUERA DE PASO TAPON DE ACEITE TAPON DE GASOLINA	CON LLAVE REGULAR
4 CIL, 1.6 L	1998	6362 GS	ALT.	

**TIGUAN**

4 CIL, 2.0 L	2010	K060439	SERPENTIN	
4 CIL, 2.0 L	2009	K060439	SERPENTIN	

**TOUAREG**

V-6, 3.0 L DIESEL	2010	T42044 K060975	POLEA DE DISTRIBUCION SERPENTIN	
V-6, 3.0 L DIESEL	2009	T42044 K060975	POLEA DE DISTRIBUCION SERPENTIN	
V-6, 3.6 L	2008	DK070817 31100 31529 38317	SERPENTIN TAPON DE ACEITE TAPONES DE RADIADOR TENSOR	22 LBS.
V-6, 3.6 L	2007	DK070817 31100 31676	SERPENTIN TAPON DE ACEITE TAPON DE GASOLINA	

									
V-6, 3.6 L	2007	31703 31529 38317	TAPON DE GASOLINA TAPON DE RADIADOR TENSOR MICRO-V	CON LLAVE 22 LIBRAS	5 CIL, 2.4 L	2009	T43139 T331 TCK331 T42097 K050350 K050335 T43139	TENSOR BANDA ARBOL DE LEVAS KIT DE DISTRIBUCION POLEA DE DISTRIBUCION SERPENTIN SERPENTIN TENSOR	142 D X 23 MM
V-8, 4.2 L	2007	K050440 31676 31703 31529	SERPENTIN TAPON DE GASOLINA TAPON DE GASOLINA TAPON DE RADIADOR	ALTERNADOR CON LLAVE 22 LIBRAS			T43139 T331 TCK331 T42097 K050335 K050350 T43139	TENSOR BANDA ARBOL DE LEVAS KIT DE DISTRIBUCION POLEA DE DISTRIBUCION SERPENTIN SERPENTIN TENSOR	ALT. A.A.
V-6, 3.2 L	2006	DK070817 31100 31676 31529 38317	SERPENTIN TAPON DE ACEITE TAPON DE GASOLINA TAPON DE RADIADOR TENSOR MICRO-V	SIN LLAVE REGULAR (22 lbs) Sin Palanca	5 CIL, 2.5 L	2009	T331 TCK331 T42097 K050335 K050350 T43139	BANDA ARBOL DE LEVAS KIT DE DISTRIBUCION POLEA DE DISTRIBUCION SERPENTIN SERPENTIN TENSOR	142 D X 23 MM
V-8, 4.2 L	2006	T297 22269 T41228 T41230 K070931 31676 31529 T41098 T43032	BANDA ARBOL DE LEVAS MANG. SUP. POLEA LOCA POLEA LOCA SERPENTIN TAPON DE GASOLINA TAPON DE RADIADOR TENSOR ARBOL DE LEVAS TENSOR ARBOL DE LEVAS	C/BANDA (MODELO USA) MOTOR A TUBO INFERIOR SUPERIOR SIN LLAVE REGULAR (22 lbs) Sin Palanca	5 CIL, 2.4 L	2008	T331 TCK331 T42097 K050355 K050350 T43139	BANDA ARBOL DE LEVAS KIT DE DISTRIBUCION POLEA DE DISTRIBUCION SERPENTIN SERPENTIN TENSOR	142 DIENTES X 23MM
V-6, 3.2 L	2005	31100 31676 31529	TAPON DE ACEITE TAPON DE GASOLINA TAPON DE RADIADOR	SIN LLAVE REGULAR (22 lbs) Sin Palanca			T43139 T331 TCK331 T42097 K050350 K050355 T43139	TENSOR BANDA ARBOL DE LEVAS KIT DE DISTRIBUCION POLEA DE DISTRIBUCION SERPENTIN SERPENTIN TENSOR	142 DIENTES X 23MM
V-8, 4.2 L	2005	T297 K070931 31676 31529	BANDA ARBOL DE LEVAS SERPENTIN TAPON DE GASOLINA TAPON DE RADIADOR	C/BANDA (MODELO USA) SIN LLAVE REGULAR (22 lbs) Sin Palanca	5 CIL, 2.3 L	2004	38018 6DPK1838 DK060729 31280 31832 31780 31329 38190 33188 38018 6DPK1838 DK060729 31280 31832 31780 31329 38190 T331 38018 31280 31780 31832 31329 T331 38018 31280 31832 31780 31329 31329 38018 31280 31832 31780 31329 31329 38018 31780 31832 31329 T331 38018 31280 31832 31780 31329 31329 38018 31780 31832 31329 T252 T311 22251 38018 31280 31832 31780 31329	POLEA SERPENTIN SERPENTIN TAPON DE ACEITE TAPON DE GASOLINA TAPON DE GASOLINA TAPON DE RADIADOR TENSOR MICRO-V TERMOSTATO POLEA SERPENTIN SERPENTIN TAPON DE ACEITE TAPON DE GASOLINA TAPON DE GASOLINA TAPON DE RADIADOR TENSOR MICRO-V BANDA ARBOL DE LEVAS POLEA TAPON DE ACEITE TAPON DE GASOLINA TAPON DE GASOLINA TAPON DE RADIADOR BANDA ARBOL DE LEVAS POLEA TAPON DE ACEITE TAPON DE GASOLINA TAPON DE GASOLINA TAPON DE RADIADOR BANDA ARBOL DE LEVAS POLEA TAPON DE ACEITE TAPON DE GASOLINA TAPON DE GASOLINA TAPON DE RADIADOR BANDA ARBOL DE LEVAS POLEA TAPON DE GASOLINA TAPON DE GASOLINA TAPON DE RADIADOR BANDA ARBOL DE LEVAS POLEA TAPON DE GASOLINA TAPON DE GASOLINA TAPON DE RADIADOR BANDA ARBOL DE LEVAS POLEA TAPON DE GASOLINA TAPON DE GASOLINA TAPON DE RADIADOR BANDA ARBOL DE LEVAS POLEA TAPON DE GASOLINA TAPON DE GASOLINA TAPON DE RADIADOR BANDA ARBOL DE LEVAS MANG. SUP. POLEA TAPON DE ACEITE TAPON DE GASOLINA TAPON DE GASOLINA TAPON DE RADIADOR	S/AA C/BANDA DE DOBLE PE C/AA C/BANDA DE DOBLE PE SIN LLAVE REGULAR CON LLAVE REGULAR (22 lbs) Sin Palanca 180°F S/AA C/BANDA DE DOBLE PE C/AA C/BANDA DE DOBLE PE SIN LLAVE REGULAR CON LLAVE REGULAR (22 lbs) Sin Palanca SIN LLAVE REGULAR CON LLAVE REGULAR (22 lbs) Sin Palanca (142 D x 23 mm) SIN LLAVE REGULAR CON LLAVE REGULAR (22 lbs) Sin Palanca SIN LLAVE REGULAR CON LLAVE REGULAR (22 lbs) Sin Palanca SIN LLAVE REGULAR CON LLAVE REGULAR (22 lbs) Sin Palanca Motor NS 1266127 & Antes Motor NS 1266128 & Después SIN LLAVE REGULAR CON LLAVE REGULAR (22 lbs) Sin Palanca

**TRANSPORTER**

4 CIL, 2.0 L TDI	2010	K060425 K060612	SERPENTIN SERPENTIN
------------------	------	--------------------	------------------------

**VW VAN**











4 CIL, 1.6 L	2006	TMV-23001	TENSOR MICRO-V
4 CIL, 1.8 L	2006	T260 7295 7270 K060455 K060385	BANDA ARBOL DE LEVAS BANDA V BANDA V SERPENTIN SERPENTIN
4 CIL, 1.6 L	2005	TPG-23001 TMV-23001	TENSOR ARBOL DE LEVAS TENSOR MICRO-V
4 CIL, 1.8 L	2005	T260 7270 7295 K060385 K060455	BANDA ARBOL DE LEVAS BANDA V BANDA V SERPENTIN SERPENTIN
4 CIL, 1.6 L	2004	7270 7295 K060385 K060455	BANDA V BANDA V SERPENTIN SERPENTIN
4 CIL, 1.6 L	2003	TPG-23001 TMV-23001 K060385 TPG-23001 TMV-23001	TENSOR ARBOL DE LEVAS TENSOR MICRO-V SERPENTIN TENSOR ARBOL DE LEVAS TENSOR MICRO-V

**VOLVO****C30**











5 CIL, 2.4 L	2010	T331 TCK331 T42097 K050350 K050335 T43139	BANDA ARBOL DE LEVAS KIT DE DISTRIBUCION POLEA DE DISTRIBUCION SERPENTIN SERPENTIN TENSOR	142 D X 23 MM ALT. A.A.	5 CIL, 2.4 L 5 CIL, 2.3 L
5 CIL, 2.5 L	2010	T331 TCK331 T42097 K050350 K050335	BANDA ARBOL DE LEVAS KIT DE DISTRIBUCION POLEA DE DISTRIBUCION SERPENTIN SERPENTIN	142 D X 23 MM ALT. A.A.	

**C70**

5 CIL, 2.3 L	2004	38018 6DPK1838 DK060729 31280 31832 31780 31329 38190 33188 38018 6DPK1838 DK060729 31280 31832 31780 31329 38190 T331 38018 31280 31780 31832 31329 T331 38018 31280 31832 31780 31329 31329 38018 31280 31832 31780 31329 31329 38018 31780 31832 31329 T331 38018 31280 31832 31780 31329 31329 38018 31780 31832 31329 T252 T311 22251 38018 31280 31832 31780 31329	POLEA SERPENTIN SERPENTIN TAPON DE ACEITE TAPON DE GASOLINA TAPON DE GASOLINA TAPON DE RADIADOR TENSOR MICRO-V TERMOSTATO POLEA SERPENTIN SERPENTIN TAPON DE ACEITE TAPON DE GASOLINA TAPON DE GASOLINA TAPON DE RADIADOR TENSOR MICRO-V BANDA ARBOL DE LEVAS POLEA TAPON DE ACEITE TAPON DE GASOLINA TAPON DE GASOLINA TAPON DE RADIADOR BANDA ARBOL DE LEVAS POLEA TAPON DE ACEITE TAPON DE GASOLINA TAPON DE GASOLINA TAPON DE RADIADOR BANDA ARBOL DE LEVAS POLEA TAPON DE ACEITE TAPON DE GASOLINA TAPON DE GASOLINA TAPON DE RADIADOR BANDA ARBOL DE LEVAS POLEA TAPON DE GASOLINA TAPON DE GASOLINA TAPON DE RADIADOR BANDA ARBOL DE LEVAS POLEA TAPON DE GASOLINA TAPON DE GASOLINA TAPON DE RADIADOR BANDA ARBOL DE LEVAS MANG. SUP. POLEA TAPON DE ACEITE TAPON DE GASOLINA TAPON DE GASOLINA TAPON DE RADIADOR	S/AA C/BANDA DE DOBLE PE C/AA C/BANDA DE DOBLE PE SIN LLAVE REGULAR CON LLAVE REGULAR (22 lbs) Sin Palanca 180°F S/AA C/BANDA DE DOBLE PE C/AA C/BANDA DE DOBLE PE SIN LLAVE REGULAR CON LLAVE REGULAR (22 lbs) Sin Palanca SIN LLAVE REGULAR CON LLAVE REGULAR (22 lbs) Sin Palanca (142 D x 23 mm) SIN LLAVE REGULAR CON LLAVE REGULAR (22 lbs) Sin Palanca SIN LLAVE REGULAR CON LLAVE REGULAR (22 lbs) Sin Palanca SIN LLAVE REGULAR CON LLAVE REGULAR (22 lbs) Sin Palanca SIN LLAVE REGULAR CON LLAVE REGULAR (22 lbs) Sin Palanca Motor NS 1266127 & Antes Motor NS 1266128 & Después SIN LLAVE REGULAR CON LLAVE REGULAR (22 lbs) Sin Palanca
--------------	------	--	--	--

    				    					
5 CIL, 2.4 L	2001	T311 T252 22251 38018 31280 31832 31780 31329	BANDA ARBOL DE LEVAS BANDA ARBOL DE LEVAS MANG. SUP. POLEA TAPON DE ACEITE TAPON DE GASOLINA TAPON DE GASOLINA TAPON DE RADIADOR	Motor NS 1266128 & Después Motor NS 1266127 & Antes  SIN LLAVE REGULAR CON LLAVE REGULAR (22 lbs) Sin Palanca	5 CIL, 2.4 L	2006	T43139 T331 TCK331 T42097 K050350 K050335 T43139	TENSOR BANDA ARBOL DE LEVAS KIT DE DISTRIBUCION POLEA DE DISTRIBUCION SERPENTIN SERPENTIN TENSOR	142 DIENTES X 23MM   A.A. & ALT. A.A.
5 CIL, 2.3 L	2000	T252 T311 22253 22251 38018 31780 31832 31329 33209	BANDA ARBOL DE LEVAS BANDA ARBOL DE LEVAS MANGUERA INF. MANGUERA SUP. POLEA TAPON DE GASOLINA TAPON DE GASOLINA TAPON DE RADIADOR TERMOSTATO	Motor NS 1266128 & Antes Motor NS 1266128 & Después  CON LLAVE REGULAR SIN LLAVE REGULAR (22 lbs) Sin Palanca 195°F	5 CIL, 2.4 L  4 CIL, 1.9 L	2005	T331 TCK331 T42097 K050350 K050335 T43139	BANDA ARBOL DE LEVAS KIT DE DISTRIBUCION POLEA DE DISTRIBUCION SERPENTIN SERPENTIN TENSOR	142 DIENTES X 23MM  A.A. & ALT. A.A.
5 CIL, 2.4 L	2000	T311 T252 22252 22253 22251 38018 31280 31780 31832 31329 33209	BANDA ARBOL DE LEVAS BANDA ARBOL DE LEVAS MANGUERA INF. MANGUERA SUP. POLEA TAPON DE ACEITE TAPON DE GASOLINA TAPON DE GASOLINA TAPON DE RADIADOR TERMOSTATO	Motor NS 1266128 & Después Motor NS 1266127 & Antes S/Turbo C/Turbo	4 CIL, 1.9 L	2003	T331 38018 6DPK1838 31832 31329 38190 33209	BANDA ARBOL DE LEVAS POLEA SERPENTIN TAPON DE GASOLINA TAPON DE RADIADOR TENSOR MICRO-V TERMOSTATO	MOTOR NS 1219111 & DESPI  SIN LLAVE REGULAR (22 lbs) Sin Palanca 195°F
5 CIL, 2.4 L	2000	T311 T252 22252 22253 22251 38018 31280 31780 31832 31329 33209	BANDA ARBOL DE LEVAS BANDA ARBOL DE LEVAS MANGUERA INF. MANGUERA SUP. POLEA TAPON DE ACEITE TAPON DE GASOLINA TAPON DE GASOLINA TAPON DE RADIADOR TERMOSTATO	Motor NS 1266128 & Después Motor NS 1266127 & Antes S/Turbo C/Turbo	4 CIL, 1.9 L	2003	T331 38018 6DPK1838 31832 31329 38190 33209	BANDA ARBOL DE LEVAS POLEA SERPENTIN TAPON DE GASOLINA TAPON DE RADIADOR TENSOR MICRO-V TERMOSTATO	MOTOR NS 1219111 & DESPI  SIN LLAVE REGULAR (22 lbs) Sin Palanca 195°F
5 CIL, 2.3 L	1999	T311 22253 22251 31329 33209	BANDA ARBOL DE LEVAS MANGUERA INF. MANGUERA SUP. TAPON DE RADIADOR TERMOSTATO	(22 lbs) Sin Palanca 195°F	4 CIL, 1.9 L	2002	T331 38018 6DPK1838 31832 31329 38190 33209	BANDA ARBOL DE LEVAS POLEA SERPENTIN TAPON DE GASOLINA TAPON DE RADIADOR TENSOR MICRO-V TERMOSTATO	MOTOR NS 1219111 & DESPI  SIN LLAVE REGULAR (22 lbs) Sin Palanca 195°F
5 CIL, 2.4 L	1999	T311 22253 22252 22251 DK060729 31280 31329 33209	BANDA ARBOL DE LEVAS MANGUERA INF. MANGUERA INF. MANGUERA SUP. SERPENTIN TAPON DE ACEITE TAPON DE RADIADOR TERMOSTATO	C/Turbo S/Turbo  (22 lbs) Sin Palanca 195°F	4 CIL, 1.9 L	2001	T252 T311 38018 6DPK1838 31280 31832 31780 31329 33209	BANDA ARBOL DE LEVAS BANDA ARBOL DE LEVAS POLEA SERPENTIN TAPON DE ACEITE TAPON DE GASOLINA TAPON DE GASOLINA TAPON DE RADIADOR TERMOSTATO	Motor NS 1219110 & Antes Motor NS 1219111 & Después  SIN LLAVE REGULAR CON LLAVE REGULAR (22 lbs) Sin Palanca 195°F
<b>C70 T5</b>					4 CIL, 1.9 L	2000	T252 T311 38018 6DPK1838 31280 31832 31780 31329 33209	BANDA ARBOL DE LEVAS BANDA ARBOL DE LEVAS POLEA SERPENTIN TAPON DE ACEITE TAPON DE GASOLINA TAPON DE GASOLINA TAPON DE RADIADOR TERMOSTATO	Motor NS 1219110 & Antes Motor NS 1219111 & Después  SIN LLAVE REGULAR CON LLAVE REGULAR (22 lbs) Sin Palanca 195°F
5 CIL, 2.3 L	2000	T269 22253 22251 31832 31329 33209	BANDA ARBOL DE LEVAS MANGUERA INF. MANGUERA SUP. TAPON DE GASOLINA TAPON DE RADIADOR TERMOSTATO	C/AA, C/DH C/AA, C/DH SIN LLAVE REGULAR (22 lbs) Sin Palanca 195°F	4 CIL, 1.9 L	2000	T252 T311 38018 6DPK1838 31280 31832 31780 31329 33209	BANDA ARBOL DE LEVAS BANDA ARBOL DE LEVAS POLEA SERPENTIN TAPON DE ACEITE TAPON DE GASOLINA TAPON DE GASOLINA TAPON DE RADIADOR TERMOSTATO	Motor NS 1219110 & Antes Motor NS 1219111 & Después  SIN LLAVE REGULAR CON LLAVE REGULAR (22 lbs) Sin Palanca 195°F
<b>S40</b>					4 CIL, 2.0 L	2000	6DPK1838	SERPENTIN	
5 CIL, 2.4 L	2008	T331 TCK331 T42097 K050350 K050355 T43139	BANDA ARBOL DE LEVAS KIT DE DISTRIBUCION POLEA DE DISTRIBUCION SERPENTIN SERPENTIN TENSOR	142 DIENTES X 23MM  ALTERNADOR A.A.	5 CIL, 2.4 L 5 CIL, 2.5 L	2006	38018 T331 22819 22817 38018 DK060725	POLEA BANDA ARBOL DE LEVAS MANG. INF. MANG. SUP. POLEA SERPENTIN	
5 CIL, 2.5 L	2008	T331 TCK331 T42097 K050355 K050350 T43139	BANDA ARBOL DE LEVAS KIT DE DISTRIBUCION POLEA DE DISTRIBUCION SERPENTIN SERPENTIN TENSOR	142 DIENTES X 23MM  A.A. ALTERNADOR	5 CIL, 2.5 L	2006	31280 31832 31329 38190 33209	TAPON DE ACEITE TAPON DE GASOLINA TAPON DE RADIADOR TENSOR MICRO-V TERMOSTATO	SIN LLAVE REGULAR (22 lbs) Sin Palanca 195°F
5 CIL, 2.4 L	2007	T331 TCK331 T42097 K050355 K050350 T43139	BANDA ARBOL DE LEVAS KIT DE DISTRIBUCION POLEA DE DISTRIBUCION SERPENTIN SERPENTIN TENSOR	142 DIENTES X 23MM  A.A. ALTERNADOR	5 CIL, 2.5 L	2005	T331 22819 22817 38018 DK060725	BANDA ARBOL DE LEVAS MANG. INF. MANG. SUP. POLEA SERPENTIN	
5 CIL, 2.5 L	2007	T331 TCK331 T42097 K050355 K050350	BANDA ARBOL DE LEVAS KIT DE DISTRIBUCION POLEA DE DISTRIBUCION SERPENTIN SERPENTIN	142 DIENTES X 23MM  A.A. ALTERNADOR	5 CIL, 2.5 L	2005	31280 31832 31329	TAPON DE ACEITE TAPON DE GASOLINA TAPON DE RADIADOR	SIN LLAVE REGULAR (22 lbs) Sin Palanca
<b>S60</b>					5 CIL, 2.4 L 5 CIL, 2.5 L	2006	38018 T331 22819 22817 38018 DK060725	POLEA BANDA ARBOL DE LEVAS MANG. INF. MANG. SUP. POLEA SERPENTIN	
5 CIL, 2.5 L	2008	T331 TCK331 T42097 K050355 K050350 T43139	BANDA ARBOL DE LEVAS KIT DE DISTRIBUCION POLEA DE DISTRIBUCION SERPENTIN SERPENTIN TENSOR	142 DIENTES X 23MM  A.A. ALTERNADOR	5 CIL, 2.5 L	2006	31280 31832 31329 38190 33209	TAPON DE ACEITE TAPON DE GASOLINA TAPON DE RADIADOR TENSOR MICRO-V TERMOSTATO	SIN LLAVE REGULAR (22 lbs) Sin Palanca 195°F
5 CIL, 2.4 L	2007	T331 TCK331 T42097 K050355 K050350 T43139	BANDA ARBOL DE LEVAS KIT DE DISTRIBUCION POLEA DE DISTRIBUCION SERPENTIN SERPENTIN TENSOR	142 DIENTES X 23MM  A.A. ALTERNADOR	5 CIL, 2.5 L	2005	T331 22819 22817 38018 DK060725	BANDA ARBOL DE LEVAS MANG. INF. MANG. SUP. POLEA SERPENTIN	
5 CIL, 2.5 L	2007	T331 TCK331 T42097 K050355 K050350	BANDA ARBOL DE LEVAS KIT DE DISTRIBUCION POLEA DE DISTRIBUCION SERPENTIN SERPENTIN	142 DIENTES X 23MM  A.A. ALTERNADOR	5 CIL, 2.5 L	2005	31280 31832 31329	TAPON DE ACEITE TAPON DE GASOLINA TAPON DE RADIADOR	SIN LLAVE REGULAR (22 lbs) Sin Palanca



									
5 CIL, 2.5 L	2005	38190 33209	SENSOR MICRO-V TERMOSTATO	195°F			33209	TERMOSTATO	195°F
					<b>S80</b>				
5 CIL, 2.5 L	2004	T331 22819 22817 38018 DK060725	BANDA ARBOL DE LEVAS MANG. INF. MANG. SUP. POLEA SERPENTIN	SIN LLAVE REGULAR (22 lbs) Sin Palanca	5 CIL, 2.5 L	2006	T331 38018 DK060718	BANDA ARBOL DE LEVAS POLEA SERPENTIN	
		31280 31832 31329 38190 33209	TAPON DE ACEITE TAPON DE GASOLINA TAPON DE RADIADOR SENSOR MICRO-V TERMOSTATO	195°F	5 CIL, 2.5 L	2005	T331 38018 DK060718	BANDA ARBOL DE LEVAS POLEA SERPENTIN	
5 CIL, 2.4 L	2003	T331 38018 31280 31832 31329 33209	BANDA ARBOL DE LEVAS POLEA TAPON DE ACEITE TAPON DE GASOLINA TAPON DE RADIADOR TERMOSTATO	SIN LLAVE REGULAR (22 lbs) Sin Palanca 195°F	6 CIL, 2.9 L	2005	T319 22677 22676 38018 6DPK1838	BANDA ARBOL DE LEVAS MANG. INF. MANG. SUP. POLEA SERPENTIN	VIN 044277 & ANTERIOR
5 CIL, 2.3 L	2001	T252 T311 22819 22251 38018 6DPK1838	BANDA ARBOL DE LEVAS BANDA ARBOL DE LEVAS MANG. INF. MANG. SUP. POLEA SERPENTIN	Motor NS 1266127 & Antes Motor NS 1266128 & Despues S/AA	6 CIL, 2.9 L	2004	T319 22677 22676 38018 6DPK1838	BANDA ARBOL DE LEVAS MANG. INF. MANG. SUP. POLEA SERPENTIN	VIN 044277 & ANTERIOR
		31280 31780 31832 31329 33209	TAPON DE ACEITE TAPON DE GASOLINA TAPON DE GASOLINA TAPON DE RADIADOR TERMOSTATO	CON LLAVE REGULAR SIN LLAVE REGULAR (22 lbs) Sin Palanca 195°F	6 CIL, 2.9 L	2004	31280 31832 31329 38190 T319	TAPON DE ACEITE TAPON DE GASOLINA TAPON DE RADIADOR TENSOR MICRO-V BANDA ARBOL DE LEVAS	SIN LLAVE REGULAR (22 lbs) Sin Palanca
5 CIL, 2.4 L	2001	T311 T252 22819 22251 38018 6DPK1838	BANDA ARBOL DE LEVAS BANDA ARBOL DE LEVAS MANG. INF. MANG. SUP. POLEA SERPENTIN	Motor NS 1266128 & Despues Motor NS 1266127 & Antes S/AA	6 CIL, 2.9 L	2003	T319 22677 22676 38018 6DPK1838	BANDA ARBOL DE LEVAS MANG. INF. MANG. SUP. POLEA SERPENTIN	VIN 044277 & ANTERIOR
		31280 31780 31832 31329 33209	TAPON DE ACEITE TAPON DE GASOLINA TAPON DE GASOLINA TAPON DE RADIADOR TERMOSTATO	CON LLAVE REGULAR SIN LLAVE REGULAR (22 lbs) Sin Palanca 195°F	6 CIL, 2.9 L	2002	31280 31832 31329 38190 T319	TAPON DE ACEITE TAPON DE GASOLINA TAPON DE RADIADOR TENSOR MICRO-V BANDA ARBOL DE LEVAS	SIN LLAVE REGULAR (22 lbs) Sin Palanca
					<b>S70</b>				
5 CIL, 2.3 L	2000	T311 T252 22253 22251 38018 6DPK1838	BANDA ARBOL DE LEVAS BANDA ARBOL DE LEVAS MANGUERA INF. MANGUERA SUP. POLEA SERPENTIN	Motor NS 1266128 & Despues Motor NS 1266127 & Antes S/AA	6 CIL, 2.8 L	2001	6DPK1838 31280 31832 31329 38190	SERPENTIN TAPON DE ACEITE TAPON DE GASOLINA TAPON DE RADIADOR TENSOR MICRO-V	VIN 044277 & ANTERIOR SIN LLAVE REGULAR (22 lbs) Sin Palanca
		DK060729	SERPENTIN	C/AA	6 CIL, 2.8 L	2001	T270	BANDA ARBOL DE LEVAS	{146 D x 28 mm}
5 CIL, 2.4 L	2000	T311 T252 22253 22252 22251 22251	BANDA ARBOL DE LEVAS BANDA ARBOL DE LEVAS MANGUERA INF. MANGUERA INF. MANGUERA SUP. MANGUERA SUP.	Motor NS 1266127 & Antes Motor NS 1266128 & Despues C/AA, C/DH C/AA, C/DH, TURBO C/AA, C/DH	6 CIL, 2.9 L	2001	T270 T319 22677 22676 38018 6DPK1838	BANDA ARBOL DE LEVAS BANDA ARBOL DE LEVAS MANG. INF. MANG. SUP. POLEA SERPENTIN	VIN 044277 & ANTERIOR
		38018 31832 31329 33209	POLEA TAPON DE GASOLINA TAPON DE RADIADOR TERMOSTATO	SIN LLAVE REGULAR (22 lbs) Sin Palanca 195°F	6 CIL, 2.9 L	2001	T319 22677 22676 38018 6DPK1838	BANDA ARBOL DE LEVAS BANDA ARBOL DE LEVAS MANG. INF. MANG. SUP. POLEA SERPENTIN	VIN 044277 & ANTERIOR
5 CIL, 2.3 L	1999	T311 22253 22251 31280	BANDA ARBOL DE LEVAS MANGUERA INF. MANGUERA SUP. TAPON DE ACEITE	195°F	6 CIL, 2.8 L	2000	T270 T319 22677 22676 38018 6DPK1838	BANDA ARBOL DE LEVAS BANDA ARBOL DE LEVAS MANG. INF. MANG. SUP. POLEA SERPENTIN	VIN 044277 & ANTERIOR
		33209	TERMOSTATO	195°F	6 CIL, 2.8 L	2000	31280 31780 31832 31329	TAPON DE ACEITE TAPON DE GASOLINA TAPON DE GASOLINA TAPON DE RADIADOR	CON LLAVE REGULAR SIN LLAVE REGULAR (22 lbs) Sin Palanca
5 CIL, 2.4 L	1999	T311 22253 22252 22251 31280 31832 31329	BANDA ARBOL DE LEVAS MANGUERA INF. MANGUERA INF. MANGUERA SUP. TAPON DE ACEITE TAPON DE GASOLINA TAPON DE RADIADOR	SIN LLAVE REGULAR (22 lbs) Sin Palanca C/Turbo S/Turbo	6 CIL, 2.8 L	2000	T270 T319 22677 22676 38018 6DPK1838	BANDA ARBOL DE LEVAS BANDA ARBOL DE LEVAS MANG. INF. MANG. SUP. POLEA SERPENTIN	VIN 044277 & ANTERIOR
		31329	TAPON DE RADIADOR	SIN LLAVE REGULAR (22 lbs) Sin Palanca	6 CIL, 2.8 L	2000	31280	TAPON DE ACEITE	VIN 044277 & ANTERIOR



6 CIL, 2.8 L	2000	31832 31329	TAPON DE GASOLINA TAPON DE RADIADOR	SIN LLAVE REGULAR (22 lbs) Sin Palanca	5 CIL, 2.3 L	1999	T311 22253	BANDA ARBOL DE LEVAS MANGUERA INF.	{142 D x 23.0 mm}
6 CIL, 2.9 L	2000	T270 T319 22677 22676 38018 DK060725 DK060718	BANDA ARBOL DE LEVAS BANDA ARBOL DE LEVAS MANG. INF. MANG. SUP. POLEA SERPENTIN SERPENTIN	VIN 044277 & POSTERIOR VIN 044276 & ANTERIOR	5 CIL, 2.4 L	1999	T311 22253 22252	TERMOSTATO BANDA ARBOL DE LEVAS MANGUERA INF.	195°F C/Turbo S/Turbo
6 CIL, 2.8 L	1999	31280 31832 31329 33209	TAPON DE ACEITE TAPON DE GASOLINA TAPON DE RADIADOR TERMOSTATO	SIN LLAVE REGULAR (22 lbs) Sin Palanca 195°F	5 CIL, 2.4 L	1999	31280 31832 31329 33209	MANGUERA SUP. TAPON DE ACEITE TAPON DE GASOLINA TAPON DE RADIADOR TERMOSTATO	SIN LLAVE REGULAR (22 lbs) Sin Palanca 195°F
6 CIL, 2.8 L	1999	T270 22677 22676	BANDA ARBOL DE LEVAS MANG. INF. MANG. SUP.		<b>XC90</b>				
6 CIL, 2.9 L	1999	T270 22677 22676	BANDA ARBOL DE LEVAS MANG. INF. MANG. SUP.						
6 CIL, 2.9 L	1999	31280 31832 31329 33209	TAPON DE ACEITE TAPON DE GASOLINA TAPON DE RADIADOR TERMOSTATO	SIN LLAVE REGULAR (22 lbs) Sin Palanca 195°F					6 CIL, 3.2 L
<b>V40</b>					6 CIL, 3.2 L	2009	k060473 31329	SERPENTIN TAPONES DE RADIADOR	22 LBS.
					6 CIL, 3.2 L	2008	k060473 31329	SERPENTIN TAPONES DE RADIADOR	22 LBS.
<b>V40</b>					6 CIL, 3.2 L	2007	k060473 31329	SERPENTIN TAPONES DE RADIADOR	22 LBS.
					5 CIL, 2.5 L	2006	T331 TCK331 T42097	BANDA ARBOL DE LEVAS KIT DE DISTRIBUCION POLEA DE DISTRIBUCION	142 D X 23 MM
4 CIL, 1.9 L	2001	T311 T252 6DPK1838	BANDA ARBOL DE LEVAS BANDA ARBOL DE LEVAS SERPENTIN	Motor NS 1219111 & Después Motor NS 1219110 & Antes	6 CIL, 3.2 L	2008	31329	SERPENTIN	22 LBS.
4 CIL, 1.9 L	2000	31280 31780 33209	TAPON DE ACEITE TAPON DE GASOLINA TERMOSTATO	CON LLAVE REGULAR 195°F	6 CIL, 3.2 L	2007	31329	TAPONES DE RADIADOR SERPENTIN	22 LBS.
4 CIL, 1.9 L	2000	T252 T311 6DPK1838	BANDA ARBOL DE LEVAS BANDA ARBOL DE LEVAS SERPENTIN	Motor NS 1219110 & Antes Motor NS 1219111 & Después 5 CIL, 2.5 L	6 CIL, 3.2 L	2007	T43139 38190	TENSOR TENSOR MICRO-V	22 LBS.
4 CIL, 1.9 L	2000	31780 33209	TAPON DE GASOLINA TERMOSTATO	CON LLAVE REGULAR 195°F	6 CIL, 3.2 L	2005	T331 TCK331 T42097	BANDA ARBOL DE LEVAS KIT DE DISTRIBUCION POLEA DE DISTRIBUCION	142 D X 23 MM
<b>V70</b>					5 CIL, 2.5 L	2004	DK060718 31280	SERPENTIN TAPON DE ACEITE	SIN LLAVE REGULAR (22 lbs) Sin Palanca
					5 CIL, 2.5 L	2004	31832 31329 T43139 38190	TAPON DE GASOLINA TAPON DE RADIADOR TENSOR TENSOR MICRO-V	142 D X 23 MM
5 CIL, 2.3 L	2001	T311 T252 22251 6DPK1838	BANDA ARBOL DE LEVAS BANDA ARBOL DE LEVAS MANG. SUP. SERPENTIN	Motor NS 1266128 & Después Motor NS 1266127 & Antes	5 CIL, 2.5 L	2004	T331 TCK331 T42097	BANDA ARBOL DE LEVAS KIT DE DISTRIBUCION POLEA DE DISTRIBUCION	142 D X 23 MM
5 CIL, 2.4 L	2001	31280 31832 31329 33209	TAPON DE ACEITE TAPON DE GASOLINA TAPON DE RADIADOR TERMOSTATO	SIN LLAVE REGULAR (22 lbs) Sin Palanca 195°F	5 CIL, 2.5 L	2003	DK060718 31280	SERPENTIN TAPON DE ACEITE	SIN LLAVE REGULAR (22 lbs) Sin Palanca
5 CIL, 2.4 L	2001	T252 T311 6DPK1838	BANDA ARBOL DE LEVAS BANDA ARBOL DE LEVAS SERPENTIN	Motor NS 1266127 & Antes Motor NS 1266128 & Después	5 CIL, 2.5 L	2003	31832 31329	TAPON DE GASOLINA TAPON DE RADIADOR	SIN LLAVE REGULAR (22 lbs) Sin Palanca
5 CIL, 2.3 L	2000	T269 T311 T252	BANDA ARBOL DE LEVAS BANDA ARBOL DE LEVAS BANDA ARBOL DE LEVAS	{144 D x 23.0 mm} Motor NS 1266128 & Después Motor NS 1266127 & Antes	5 CIL, 2.5 L	2003	T43139 38190	TENSOR TENSOR MICRO-V	142 D X 23 MM
5 CIL, 2.3 L	2000	22252 22253 22251 22251	MANGUERA INF. MANGUERA INF. MANGUERA SUP. MANGUERA SUP.	C/AA, C/DH, TURBO C/AA, C/DH C/AA, C/DH C/AA, C/DH, TURBO	5 CIL, 2.5 L	2003	TCK331 T42097 DK060718	KIT DE DISTRIBUCION POLEA DE DISTRIBUCION SERPENTIN	142 D X 23 MM
5 CIL, 2.3 L	2000	22251 6DPK1838	MANGUERA SUP. SERPENTIN	C/AA, C/DH C/AA, C/DH, TURBO	5 CIL, 2.5 L	2003	31280 31832	TAPON DE ACEITE TAPON DE GASOLINA	SIN LLAVE REGULAR (22 lbs) Sin Palanca
5 CIL, 2.3 L	2000	31832 31329 33209	TAPON DE GASOLINA TAPON DE RADIADOR TERMOSTATO	SIN LLAVE REGULAR (22 lbs) Sin Palanca 195°F	5 CIL, 2.5 L	2003	31329 T43139 38190	TAPON DE RADIADOR TENSOR TENSOR MICRO-V	SIN LLAVE REGULAR (22 lbs) Sin Palanca
5 CIL, 2.4 L	2000	T252 T311 22253	BANDA ARBOL DE LEVAS BANDA ARBOL DE LEVAS MANGUERA INF.	Motor NS 1266127 & Antes Motor NS 1266128 & Después	5 CIL, 2.5 L	2003	22252	MANGUERA INF.	SIN LLAVE REGULAR (22 lbs) Sin Palanca
5 CIL, 2.4 L	2000	22252 22251 22251	MANGUERA INF. MANGUERA SUP. MANGUERA SUP.	C/AA, C/DH C/AA, C/DH, TURBO C/AA, C/DH	5 CIL, 2.5 L	2003	22251	MANGUERA SUP.	SIN LLAVE REGULAR (22 lbs) Sin Palanca
5 CIL, 2.4 L	2000	31280 31832 31329 33209	TAPON DE ACEITE TAPON DE GASOLINA TAPON DE RADIADOR TERMOSTATO	SIN LLAVE REGULAR (22 lbs) Sin Palanca 195°F	5 CIL, 2.5 L	2003	31280 31832 31329 33209	TAPON DE ACEITE TAPON DE GASOLINA TAPON DE RADIADOR TERMOSTATO	SIN LLAVE REGULAR (22 lbs) Sin Palanca

### Bandas

#### 5641XS



MITSUBISHI	L200	4 CIL, 2.5 L	2008	-	2009
------------	------	--------------	------	---	------

#### 6208 GS



AUDI	A4	4 CIL, 1.8 L	1999	-	1999
------	----	--------------	------	---	------

#### 6294 GS



VOLKSWAGEN	BEETLE	4 CIL, 2.0 L	2000	-	2000
------------	--------	--------------	------	---	------

VOLKSWAGEN	CABRIO	4 CIL, 2.0 L	2000	-	2000
------------	--------	--------------	------	---	------

#### 6352 GS



NISSAN	XTERRA	4 CIL, 2.4 L	2000	-	2000
--------	--------	--------------	------	---	------

#### 6360GS



#### 3660 GS



NISSAN	XTERRA	4 CIL, 2.4 L	2003	-	2001
--------	--------	--------------	------	---	------

#### 4PK1102SF



FIAT	DUCATO	4 CIL, 3.0 L DIESE2008	-	-	2010
------	--------	------------------------	---	---	------

#### 4PK903SF



FIAT	DUCATO	4 CIL, 2.3 L DIESE2008	-	-	2010
------	--------	------------------------	---	---	------

#### 4PK922SF



FORD	TRANSIT	4 CIL, 2.2 L	2009	-	2008
------	---------	--------------	------	---	------

## Aplicación por Producto

NISSAN	XTERRA	4 CIL, 2.4 L	2004	-	2004
--------	--------	--------------	------	---	------

### 6417 GS

### 6362 GS



NISSAN	XTERRA	4 CIL, 2.4 L	2002	-	2000
NISSAN	FRONTIER	4 CIL, 2.4 L	2002	-	1999

### 6362GS



CHEVROLET	CHEVY PICK-UP	4 CIL, 1.6 L	2006	-	2002
CHEVROLET	CHEVY C2	4 CIL, 1.6 L	2008	-	2004
CHEVROLET	CHEVY	4 CIL, 1.6 L	2009	-	2010
CHEVROLET	CHEVY C2 SEDAN	4 CIL, 1.6 L	2008	-	2004

### 6366L



NISSAN	ESTACAS - NP300	4 CIL, 2.4 L	2008	-	2010
NISSAN	PICK-UP - NP300	4 CIL, 2.4 L	2008	-	2010
NISSAN	KING CAB	4 CIL, 2.4 L	2001	-	1997

### 6400 GS



CHRYSLER	VOYAGER	V-6, 3.0 L	1998	-	1996
----------	---------	------------	------	---	------



CHEVROLET	LUV	4 CIL, 2.2 L	2000	-	2000
DODGE	NEON	4 CIL, 2.0 L	1999	-	1999

### 6469MC



HYUNDAI	H100	4 CIL, 2.4 L	2005	-	2003
---------	------	--------------	------	---	------

### 6470MC



HYUNDAI	H100	4 CIL, 2.4 L	2005	-	2003
---------	------	--------------	------	---	------

### 6555 GS



CHRYSLER	300M	V-6, 3.5 L	2001	-	2000
CHRYSLER	CONCORDE	V-6, 3.2 L	2000	-	1998
DODGE	INTREPID	V-6, 3.2 L	2000	-	1999

### 6DPK1200

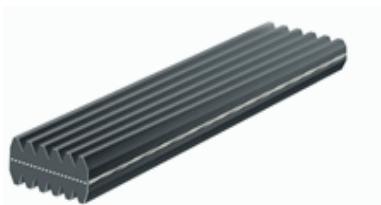

AUDI	TT	4 CIL, 1.8 L	2006	-	2000
VOLKSWAGEN	GTI	4 CIL, 2.0 L	2000	-	2000
VOLKSWAGEN	BEETLE	4 CIL, 1.8 L	2004	-	2002
VOLKSWAGEN	BEETLE	4 CIL, 2.0 L	2005	-	2005
VOLKSWAGEN	BEETLE	4 CIL, 1.8 L	2005	-	2005
VOLKSWAGEN	JETTA	4 CIL, 1.8 L	2006	-	2004
VOLKSWAGEN	JETTA	4 CIL, 2.0 L	2005	-	2005
VOLKSWAGEN	SHARAN	4 CIL, 1.8 L	2007	-	2003
VOLKSWAGEN	JETTA	4 CIL, 2.0 L	2006	-	2004
SEAT	LEON	4 CIL, 1.8 L	2005	-	2004
VOLKSWAGEN	GOLF	4 CIL, 2.0 L	2005	-	2005
VOLKSWAGEN	JETTA	4 CIL, 1.8 L	2005	-	2005
SEAT	TOLEDO	4 CIL, 1.8 L	2005	-	2004
SEAT	AHLAMBRA	4 CIL, 1.8 L	2007	-	2003
VOLKSWAGEN	EUROVAN	4 CIL, 1.9 L DIESE	2006	-	2009
VOLKSWAGEN	GOLF	4 CIL, 1.8 L	2006	-	2004
VOLKSWAGEN	GOLF	4 CIL, 2.0 L	2003	-	2004
VOLKSWAGEN	BEETLE	4 CIL, 2.0 L	2008	-	1998
VOLKSWAGEN	GOLF	4 CIL, 1.8 L	2005	-	2005

### 6DPK1838



VOLVO	C70	5 CIL, 2.4 L	2004	-	2004
VOLVO	S40	4 CIL, 1.9 L	2004	-	2000
VOLVO	C70	5 CIL, 2.3 L	2004	-	2004
VOLVO	S80	6 CIL, 2.8 L	2001	-	2000
VOLVO	V70	5 CIL, 2.4 L	2001	-	2001
VOLVO	V70	5 CIL, 2.3 L	2001	-	2000
VOLVO	V40	4 CIL, 1.9 L	2001	-	2000
VOLVO	S80	6 CIL, 2.9 L	2005	-	2001
VOLVO	S40	4 CIL, 2.0 L	2000	-	2000
VOLVO	S70	5 CIL, 2.3 L	2000	-	2000
VOLVO	S60	5 CIL, 2.3 L	2001	-	2001
VOLVO	S60	5 CIL, 2.4 L	2001	-	2001

### 6PK1019SF



FORD	FIESTA	4 CIL, 1.6 L	2011	-	2011
------	--------	--------------	------	---	------

### 6PK1600



PEUGEOT	406	V-6, 3.0 L	2001	-	1999
---------	-----	------------	------	---	------

### 7208

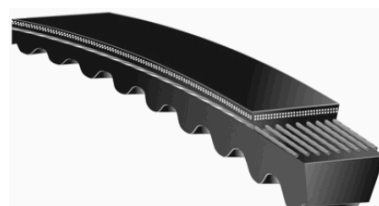

AUDI	A4	4 CIL, 1.8 L	1999	-	1998
VOLKSWAGEN	PASSAT	4 CIL, 1.8 L	2003	-	1999

### 7270

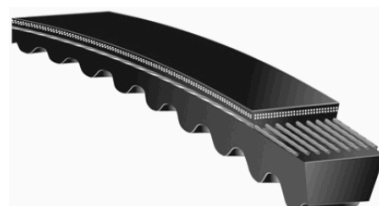

VOLKSWAGEN	VW VAN	4 CIL, 1.8 L	2006	-	2005
VOLKSWAGEN	DERBY	4 CIL, 1.8 L	2005	-	2005
VOLKSWAGEN	DERBY	4 CIL, 1.8 L	2008	-	2006
VOLKSWAGEN	VW VAN	4 CIL, 1.6 L	2004	-	2004

### 7277 GS



VOLKSWAGEN	DERBY	4 CIL, 1.8 L	2001 - 1999
------------	-------	--------------	-------------

### 7306 GS



NISSAN	FRONTIER	4 CIL, 2.4 L	2002 - 1999
NISSAN	XTERRA	4 CIL, 2.4 L	2002 - 2000

### 7295

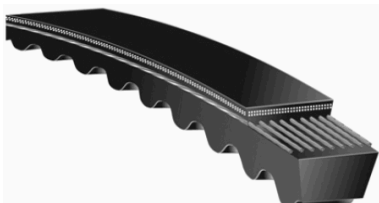

VOLKSWAGEN	DERBY	4 CIL, 2.0 L	2004 - 2004
VOLKSWAGEN	GTI	4 CIL, 2.0 L	2000 - 1999
VOLKSWAGEN	VW VAN	4 CIL, 1.6 L	2004 - 2004
VOLKSWAGEN	JETTA	4 CIL, 2.0 L	2000 - 1999
VOLKSWAGEN	VW VAN	4 CIL, 1.8 L	2005 - 2005
VOLKSWAGEN	VW VAN	4 CIL, 1.8 L	2006 - 2006
VOLKSWAGEN	DERBY	4 CIL, 1.8 L	2005 - 2005
VOLKSWAGEN	DERBY	4 CIL, 1.8 L	2008 - 2003
VOLKSWAGEN	GOLF	4 CIL, 2.0 L	2000 - 1999

### 7355

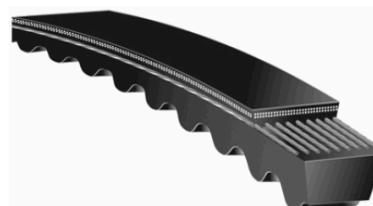

NISSAN	FRONTIER	4 CIL, 2.4 L	2004 - 2002
NISSAN	XTERRA	4 CIL, 2.4 L	2002 - 2002

### 7295 GS



VOLKSWAGEN	GOLF	4 CIL, 1.8 L	1996 - 1996
------------	------	--------------	-------------

### 7300

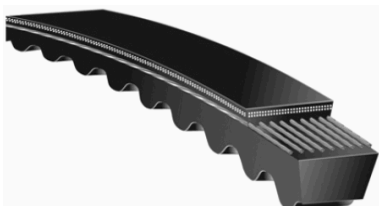

PORSCHE	911	6 CIL, 3.6 L	1998 - 1998
---------	-----	--------------	-------------

### 7371 GS



VOLKSWAGEN	POINTER PICK-UP	4 CIL, 1.8 L	2001 - 1999
VOLKSWAGEN	POINTER	4 CIL, 1.8 L	2008 - 1998

### 7371GS



VOLKSWAGEN	POINTER PICK-UP	4 CIL, 1.8 L	2005 - 1998
VOLKSWAGEN	POINTER	4 CIL, 1.8 L	2005 - 2002



**7374GS**



VOLKSWAGEN	GTI	V-6, 2.8 L	2001	-	1999
------------	-----	------------	------	---	------

**8265GS**



VOLKSWAGEN	POINTER	4 CIL, 1.8 L	2004	-	2004
------------	---------	--------------	------	---	------

**7417**

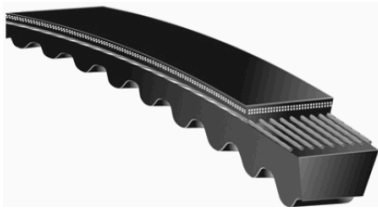

HYUNDAI	ATTITUDE	4 CIL, 1.6 L	2008	-	2010
HYUNDAI	VERNA	4 CIL, 1.6 L	2006	-	2005
HYUNDAI	ATTITUDE	4 CIL, 1.4 L	2008	-	2010
HYUNDAI	ATTITUDE	4 CIL, 1.6 L	2007	-	2006

**8334GS**



CHEVROLET	LUV	4 CIL, 2.2 L	2003	-	2001
-----------	-----	--------------	------	---	------

**7480**

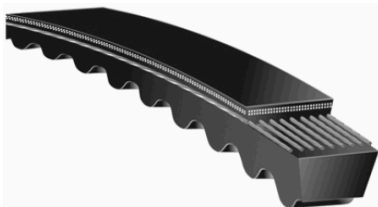

FORD	FIESTA	4 CIL, 1.4 L	2000	-	2001
------	--------	--------------	------	---	------

**8354 GS**



DODGE	NEON	4 CIL, 2.0 L	1999	-	1999
-------	------	--------------	------	---	------

**7550**

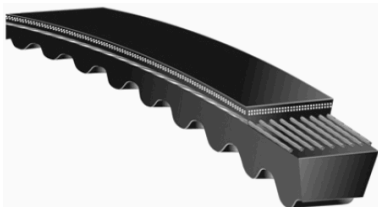

NISSAN	PATHFINDER	V-6, 3.3 L	1998	-	1998
--------	------------	------------	------	---	------

**8365 GS**



CHRYSLER	300M	V-6, 3.5 L	2004	-	1999
CHRYSLER	CONCORDE	V-6, 3.5 L	2002	-	2002

**7DPK1363**

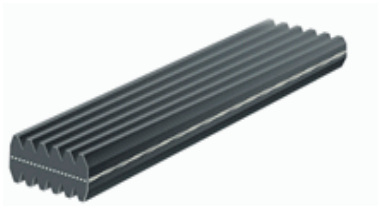

NISSAN	XTERRA	4 CIL, 2.4 L	2003	-	2001
--------	--------	--------------	------	---	------

VOLKSWAGEN	JETTA	V-6, 2.8 L	2002	-	1999
------------	-------	------------	------	---	------

**8365GS**



NISSAN XTERRA 4 CIL, 2.4 L 2004 - 2004

**8371 GS**



CHEVROLET LUV 4 CIL, 2.2 L 2000 - 2000

**8380GS**



CHEVROLET LUV 4 CIL, 2.2 L 2000 - 2000

**8430 GS**



PORSCHE 911 6 CIL, 3.6 L 1998 - 1998

**8452L**



NISSAN KING CAB 4 CIL, 2.4 L 2001 - 1997

**8494 GS**



NISSAN XTERRA 4 CIL, 2.4 L 2003 - 2000

**8494GS**



NISSAN URVAN 4 CIL, 2.4 L 2000 - 2004

NISSAN XTERRA 4 CIL, 2.4 L 2004 - 2004

**8497 GS**



NISSAN XTERRA 4 CIL, 2.4 L 2002 - 2000

NISSAN FRONTIER 4 CIL, 2.4 L 2004 - 1999

**8497GS**



NISSAN FRONTIER 4 CIL, 2.4 L 2003 - 2003

**8553 GS**



## Aplicación por Producto

DODGE	INTREPID	V-6, 3.5 L	2002	-	2000
CHRYSLER	CONCORDE	V-6, 3.2 L	2001	-	1999
DODGE	INTREPID	V-6, 3.2 L	2001	-	1999
CHRYSLER	CONCORDE	V-6, 3.5 L	2002	-	2002

**9380**

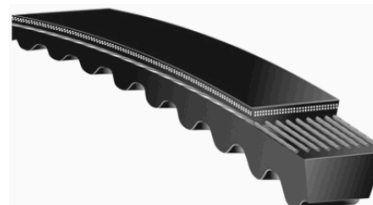

CHEVROLET	LUV	4 CIL, 2.2 L	2003	-	2001
-----------	-----	--------------	------	---	------

**9455**

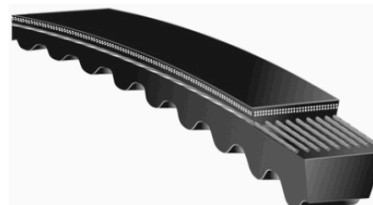

**9350**

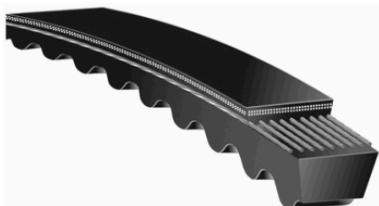

NISSAN	PATHFINDER	V-6, 3.3 L	2000	-	2000
--------	------------	------------	------	---	------

NISSAN	PICK-UP	4 CIL, 2.4 L	2007	-	2002
NISSAN	ESTAQUITAS	4 CIL, 2.4 L	2007	-	2002

**9470**

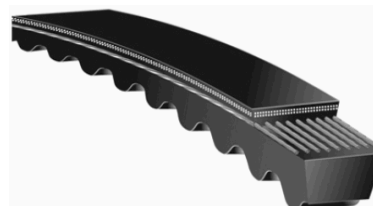

**9365**

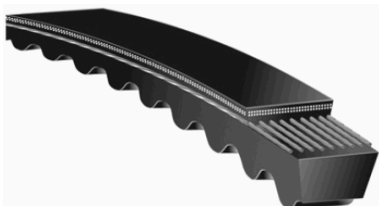

NISSAN	PICK-UP	4 CIL, 2.4 L	2007	-	2002
NISSAN	XTERRA	4 CIL, 2.4 L	2002	-	2000
NISSAN	ESTAQUITAS	4 CIL, 2.4 L	2007	-	2002
NISSAN	FRONTIER	4 CIL, 2.4 L	2004	-	2002

TOYOTA	HILUX	4 CIL, 2.7L	2006	-	2003
--------	-------	-------------	------	---	------

**9490L**

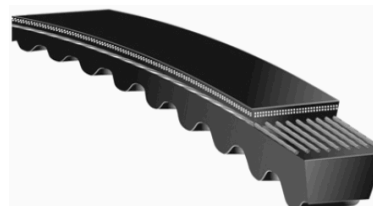

**9365L**

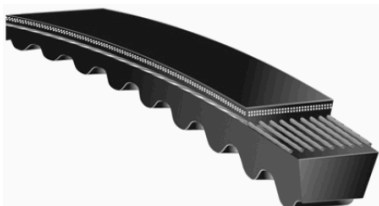

NISSAN	PICK-UP - NP300	4 CIL, 2.4 L	2008	-	2010
NISSAN	ESTACAS - NP300	4 CIL, 2.4 L	2008	-	2010

NISSAN	ESTACAS - NP300	4 CIL, 2.4 L	2008	-	2010
NISSAN	PICK-UP - NP300	4 CIL, 2.4 L	2008	-	2010

**9495**

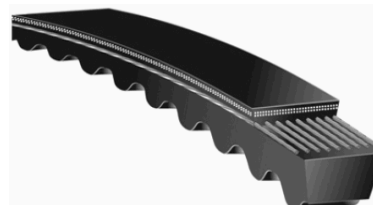

**9378**

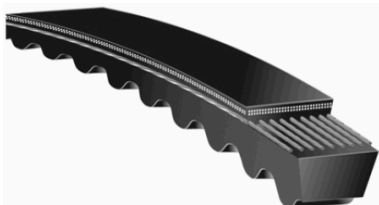

CHEVROLET	LUV	4 CIL, 2.2 L	2003	-	2001
-----------	-----	--------------	------	---	------

## Aplicación por Producto

NISSAN	FRONTIER	4 CIL, 2.4 L	2002 - 2002
NISSAN	XTERRA	4 CIL, 2.4 L	2002 - 2002

**DK060718**

**A33**

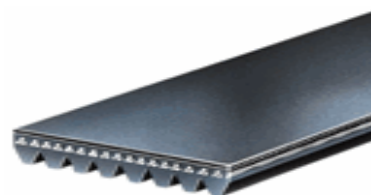

MITSUBISHI	MONTERO SPORT	V-6, 3.5 L	2004 - 2004
------------	---------------	------------	-------------

VOLVO	XC90	5 CIL, 2.5 L	2006 - 2003
VOLVO	S80	6 CIL, 2.9 L	2000 - 2000
VOLVO	S80	5 CIL, 2.5 L	2006 - 2005

**DK060725**

**DK050610**

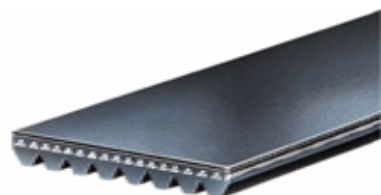

VOLKSWAGEN	BEETLE	5 CIL, 2.5 L	2008 - 2006
VOLKSWAGEN	BEETLE	5 CIL, 2.5 L	2009 - 2010

VOLVO	S60	5 CIL, 2.5 L	2006 - 2004
VOLVO	S80	6 CIL, 2.9 L	2000 - 2000

**DK060729**

**DK060472**

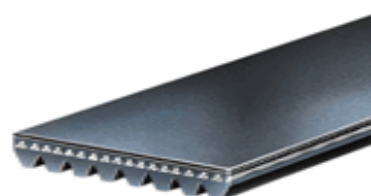
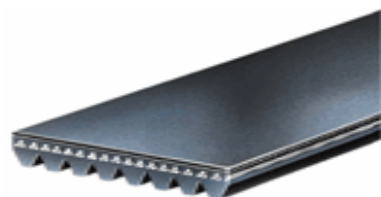

VOLKSWAGEN	JETTA	4 CIL, 2.0 L	2008 - 2010
VOLKSWAGEN	JETTA	4 CIL, 1.9 L DIESE2005	- 2004

(IMP. USA)

VOLVO	C70	5 CIL, 2.4 L	2004 - 1999
VOLVO	S70	5 CIL, 2.3 L	2000 - 2000
VOLVO	C70	5 CIL, 2.3 L	2004 - 2004

**DK070551**

**DK060519**

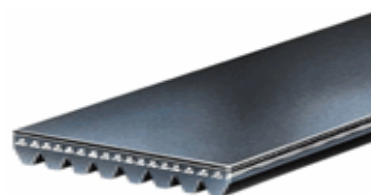
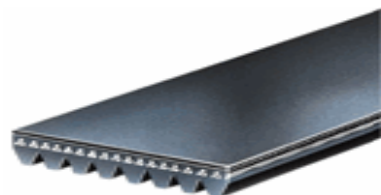

micro v doble perfil

VOLKSWAGEN	JETTA	V-6, 2.8 L	2004 - 2003
------------	-------	------------	-------------

VOLKSWAGEN	EUROVAN	6 CIL, 2.8 L	2004 - 2004
------------	---------	--------------	-------------

### DK070817

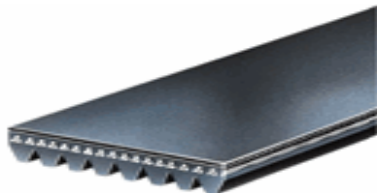

AUDI	Q7	V-6, 3.6 L	2007	-	2009
VOLKSWAGEN	TOUAREG	V-6, 3.6 L	2007	-	2008
VOLKSWAGEN	TOUAREG	V-6, 3.2 L	2006	-	2006

### K030220



FAW	F4	4 CIL, 1.4 L	2008	-	2009
-----	----	--------------	------	---	------

### K030245

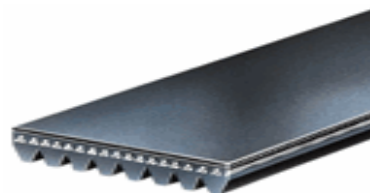

CADILLAC	DEVILLE	V-8, 4.6 L	2005	-	1999
CADILLAC	SEVILLE	V-8, 4.6 L	2004	-	1998
FAW	F5	4 CIL, 1.5 L	2008	-	2009
CADILLAC	EL DORADO	V-8, 4.6 L	2002	-	2000

### DK080534

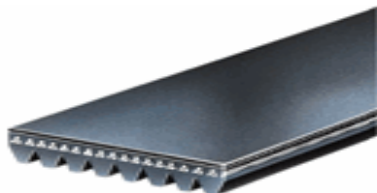

LAND ROVER	RANGE ROVER	V-8, 4.4 L	2006	-	2008
------------	-------------	------------	------	---	------

### K030195

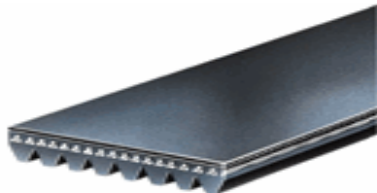

CHEVROLET	TRACKER	4 CIL, 2.0 L	2003	-	1999
-----------	---------	--------------	------	---	------

### K030195SF

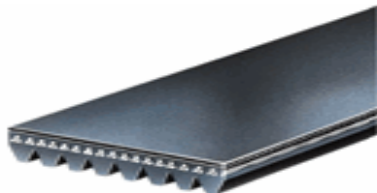

MERCURY	MARINER	V-6, 3.0 L	2007	-	2009
MERCURY	MILAN	V-6, 3.0 L	2007	-	2009
MAZDA	MAZDA 6	V-6, 3.0 L	2008	-	2008
FORD	FUSION	V-6, 3.0 L	2007	-	2009
FORD	ESCAPE	V-6, 3.0 L	2006	-	2009

### K030250

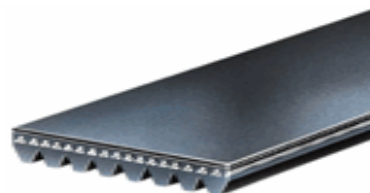

FORD	ESCAPE	V-6, 3.0 L	2001	-	2001
------	--------	------------	------	---	------

### K030250SF

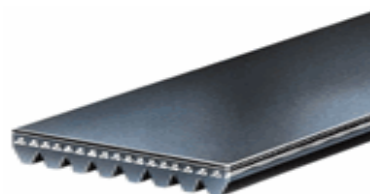

FORD	ESCAPE	V-6, 3.0 L	2005	-	2005
------	--------	------------	------	---	------



**K030267**



FIAT	PALIO ADVENTURE	4 CIL, 1.6 L	2006 - 2003
NISSAN	MICRA	4 CIL, 1.4 L	2008 - 2004
FORD	MONDEO	V-6, 2.5 L	2006 - 2003
FORD	ESCAPE	V-6, 3.0 L	2007 - 2001
FIAT	PALIO	4 CIL, 1.6 L	2006 - 2003
MERCURY	SABLE / TAURUS	V-6, 3.0 L	2005 - 2001

**K030471**

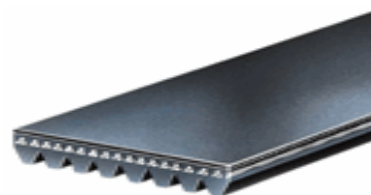

TOYOTA	CAMRY	4 CIL, 2.5 L	2010 - 2011
--------	-------	--------------	-------------

**K040220**



NISSAN	350Z	V-6, 3.5 L	2007 - 2009
--------	------	------------	-------------

**K040223**



HYUNDAI	VERNA	4 CIL, 1.5 L	2004 - 2004
---------	-------	--------------	-------------

**K040233**

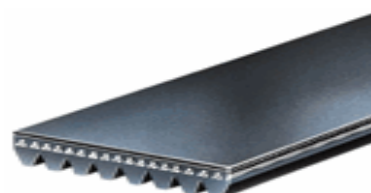

HYUNDAI	VERNA	4 CIL, 1.5 L	2006 - 2005
---------	-------	--------------	-------------

**K040250**



SUZUKI	SWIFT	4 CIL, 1.6 L	2009 - 2009
CHEVROLET	CRUZE	4 CIL, 1.8 L	2010 - 2011

**K030310**

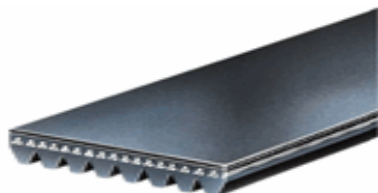

PONTIAC	SOLSTICE	4 CIL, 2.4 L	2008 - 2006
---------	----------	--------------	-------------

**K030335**

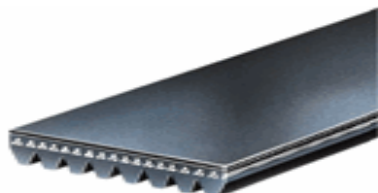

SMART	FORTWO	3 CIL, 0.8 L	2004 - 2006
-------	--------	--------------	-------------

**K030365**

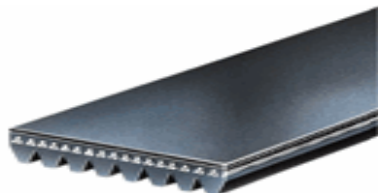

INFINITI	INFINITI Q45	V-8, 4.1 L	2001 - 1998
----------	--------------	------------	-------------

### K040262

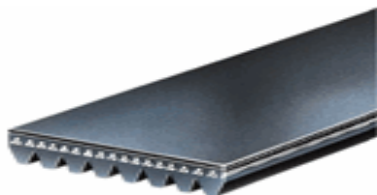

FIAT	BRAVO	4 CIL, 1.4 L	2009	-	2010
FIAT	GRANDE PUNTO	4 CIL, 1.4 L	2009	-	2010
PONTIAC	MATIZ G2	4 CIL, 1.0 L	2008	-	2009
FIAT	PANDA	4 CIL, 1.2 L	2008	-	2010

### K040300

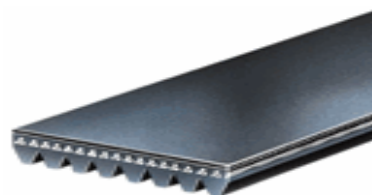

HYUNDAI	ATOS	4 CIL, 1.1 L	2008	-	2010
SMART	FORTWO	3 CIL, 0.8 L	2004	-	2006
HYUNDAI	ATOS	4 CIL, 1.0 L	2004	-	2000

### K040267

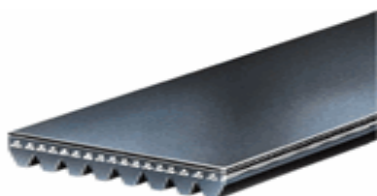

HYUNDAI	ATOS	4 CIL, 1.0 L	2004	-	2000
HYUNDAI	ATOS	4 CIL, 1.1 L	2008	-	2010

### K040305

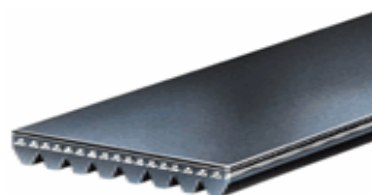

INFINITI	INFINITI Q45	V-6, 3.0 L	2001	-	2001
NISSAN	MAXIMA	V-6, 3.5 L	2007	-	2008
NISSAN	MURANO	V-6, 3.5 L	2008	-	2007
NISSAN	QUEST	6 CIL, 3.5 L	2006	-	2003
NISSAN	QUEST	V-6, 3.5 L	2007	-	2009
INFINITI	INFINITI I30	V-6, 3.0 L	2001	-	1997
HONDA	CIVIC	4 CIL, 1.6 L	2000	-	1999
NISSAN	MURANO	6 CIL, 3.5 L	2006	-	2004
MITSUBISHI	LANCER	4 CIL, 2.0 L	2007	-	2005
NISSAN	ALTIMA	V-6, 3.5 L	2006	-	2002

### K040285

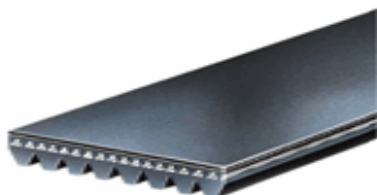

PONTIAC	MATIZ G2	4 CIL, 1.0 L	2008	-	2009
---------	----------	--------------	------	---	------

### K040310

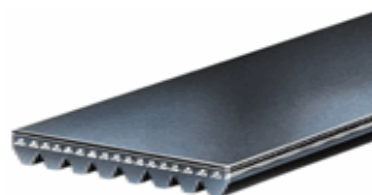

CHEVROLET	TRACKER	4 CIL, 1.6 L	2000	-	1999
PONTIAC	MATIZ G2	4 CIL, 1.0 L	2008	-	2009

### K040295

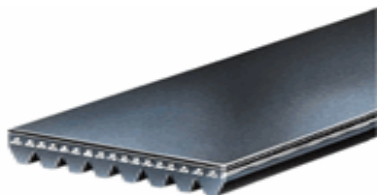

HYUNDAI	ATOS	4 CIL, 1.1 L	2008	-	2010
HYUNDAI	ATOS	4 CIL, 1.0 L	2004	-	2000

### K040315

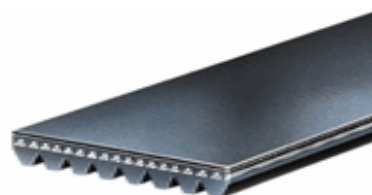

HONDA	CIVIC	4 CIL, 1.6 L	2000	-	1998
-------	-------	--------------	------	---	------

## Aplicación por Producto

CHEVROLET	TRACKER	4 CIL, 1.6 L	1998 - 1997
-----------	---------	--------------	-------------

### K040317

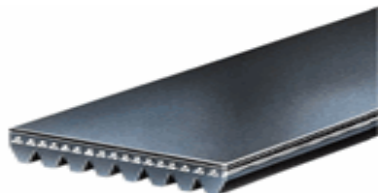

NISSAN	TSURU	4 CIL, 1.6 L	2002 - 2008
NISSAN	TSURU	4 CIL, 1.6 L	2001 - 2010

### K040319

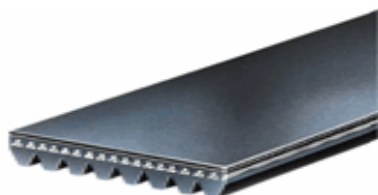

CHEVROLET	TRACKER	4 CIL, 1.6 L	1998 - 1997
HYUNDAI	ATTITUDE	4 CIL, 1.6 L	2007 - 2006
HYUNDAI	VERNA	4 CIL, 1.6 L	2006 - 2005
HYUNDAI	ATTITUDE	4 CIL, 1.6 L	2008 - 2010
HYUNDAI	ATTITUDE	4 CIL, 1.4 L	2008 - 2010
HONDA	CIVIC	4 CIL, 1.6 L	2000 - 1999

### K040320

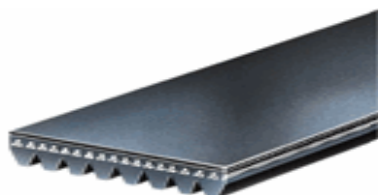

CHEVROLET	TRACKER	4 CIL, 1.6 L	2000 - 1999
FAW	F5	4 CIL, 1.5 L	2008 - 2009
FAW	F4	4 CIL, 1.4 L	2008 - 2009

### K040322

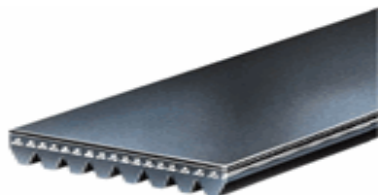

BMW	545I	V-8, 4.4 L	2004 - 2004
BMW	760LI	V-12, 6.0 L	2004 - 2004
BMW	760LI	V-12, 6.0 L	2005 - 2005

BMW	760I	V-12, 6.0 L	2005 - 2005
BMW	745LI	V-8, 4.4 L	2005 - 2005
BMW	545I	V-8, 4.4 L	2005 - 2005
BMW	745I	V-8, 4.4 L	2005 - 2003
HONDA	CR-V	4 CIL, 2.0 L	2001 - 1999
BMW	550I	V-8, 4.4 L	2006 - 2006
BMW	645CI	V-8, 4.4 L	2005 - 2005
BMW	650I	V-8, 4.4 L	2006 - 2006
BMW	745I	V-8, 4.4 L	2004 - 2004

### K040325

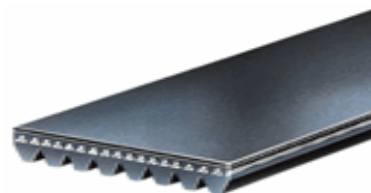

HONDA	CIVIC	4 CIL, 1.6 L	1998 - 1998
-------	-------	--------------	-------------

### K040328

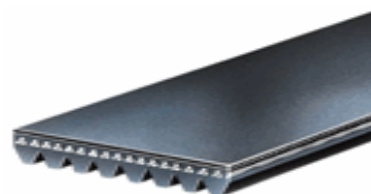

NISSAN	MICRA	4 CIL, 1.4 L	2008 - 2004
--------	-------	--------------	-------------

### K040330



NISSAN	SENTRA	4 CIL, 2.0 L	2001 - 2000
NISSAN	SENTRA	4 CIL, 2.5 L	2004 - 2004
HONDA	CIVIC	4 CIL, 1.6 L	2000 - 1999
NISSAN	SENTRA	4 CIL, 1.8 L	2006 - 2000
NISSAN	SENTRA	4 CIL, 1.8 L	2004 - 2004
CHEVROLET	TRACKER	4 CIL, 1.6 L	1998 - 1997

### K040332

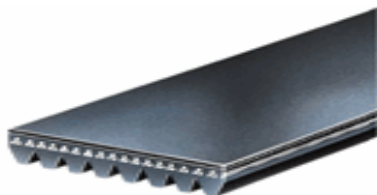

SUBARU	LEGACY	4 CIL, 2.5 L	2007 - 2006
HYUNDAI	ATTITUDE	4 CIL, 1.4 L	2008 - 2010
HYUNDAI	VERNA	4 CIL, 1.6 L	2006 - 2005
HYUNDAI	ATTITUDE	4 CIL, 1.6 L	2008 - 2010
HONDA	CR-V	4 CIL, 2.0 L	2001 - 1999
SUBARU	OUTBACK	4 CIL, 2.5 L	2007 - 2006
HYUNDAI	ATTITUDE	4 CIL, 1.6 L	2007 - 2006

### K040338

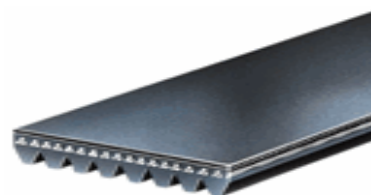

NISSAN	ALTIMA	4 CIL, 2.4 L	2001 - 1996
BMW	320I	V-6, 2.2 L	2005 - 2004
VOLKSWAGEN	PASSAT	4 CIL, 1.8 L	2005 - 2005
VOLKSWAGEN	PASSAT	4 CIL, 1.8 L	2003 - 1999
BMW	X5	V-8, 4.4 L	2004 - 2004
AUDI	A4	4 CIL, 1.8 L	1999 - 1998
CHRYSLER	SEBRING	V-6, 2.5 L	2000 - 1998

### K040335

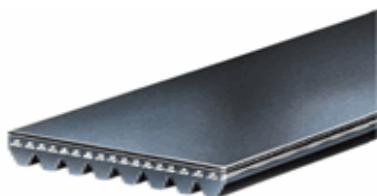

NISSAN	SENTRA	4 CIL, 2.0 L	2002 - 1998
AUDI	A4	4 CIL, 1.8 L	2002 - 2000
HYUNDAI	VERNA	4 CIL, 1.5 L	2006 - 2004
VOLKSWAGEN	PASSAT	4 CIL, 1.8 L	2004 - 2003
NISSAN	TSURU	4 CIL, 2.0 L	1996 - 1999
NISSAN	ALMERA	4 CIL, 1.8 L	2006 - 2003
DODGE	NEON	4 CIL, 2.0 L	2006 - 2000
DODGE	NEON	4 CIL, 2.0 L	2005 - 2005
NISSAN	LUCCINO	4 CIL, 2.0 L	1998 - 1996
HONDA	CIVIC	4 CIL, 1.6 L	1998 - 1998

### K040340

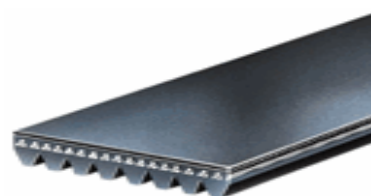

BMW	Z4	V-6, 3.0 L	2004 - 2004
BMW	325XI	6 CIL, 2.5 L	2005 - 2005
BMW	X3	6 CIL, 3.0 L	2006 - 2006
BMW	X5	6 CIL, 3.0 L	2006 - 2006
BMW	Z4	6 CIL, 2.5 L	2003 - 2003
BMW	Z4	6 CIL, 3.0 L	2003 - 2003
BMW	Z4	V-6, 2.5 L	2006 - 2004
BMW	X3	6 CIL, 3.0 L	2005 - 2005
BMW	X5	V-6, 3.0 L	2004 - 2004
BMW	325I	V-6, 2.5 L	2005 - 2004
BMW	X5	6 CIL, 3.0 L	2005 - 2005
BMW	330CI	V-6, 3.0 L	2006 - 2005
BMW	330CI	V-6, 3.0 L	2004 - 2004
BMW	330XI	6 CIL, 3.0 L	2006 - 2005

### K040337

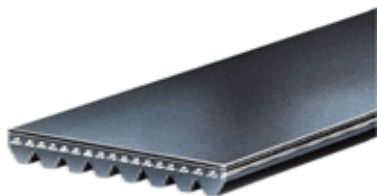

FIAT	PALIO	4 CIL, 1.6 L	2006 - 2003
FIAT	PALIO ADVENTURE	4 CIL, 1.6 L	2006 - 2003

### K040343

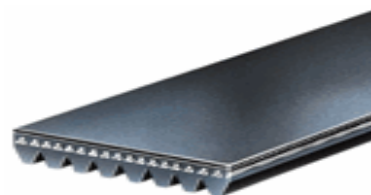

TOYOTA	4 RUNNER	V-6, 3.4 L	2002 - 2002
--------	----------	------------	-------------

### K040345

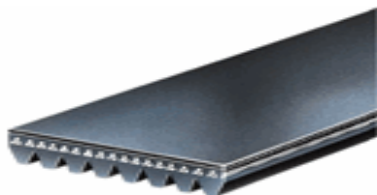

DODGE	NEON	4 CIL, 2.4 L	2005	-	2005
HONDA	CIVIC	4 CIL, 1.6 L	2000	-	1999
DODGE	NEON	4 CIL, 2.4 L	2006	-	2004
CHRYSLER	PT CRUISER	4 CIL, 2.4 L	2005	-	2005
CHRYSLER	PT CRUISER	4 CIL, 2.4 L	2007	-	2010

### K040352SF

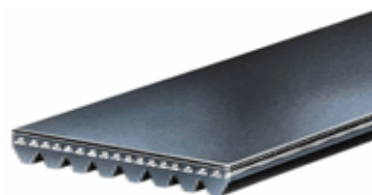

FORD	FUSION	V-6, 3.5 L	2010	-	2010
LINCOLN	MKX	V-6, 3.5 L	2007	-	2009
FORD	EDGE	V-6, 3.5 L	2007	-	2010
MAZDA	CX-9	V-6, 3.7 L	2007	-	2008
LINCOLN	MKZ	V-6, 3.5 L	2007	-	2009

### K040347

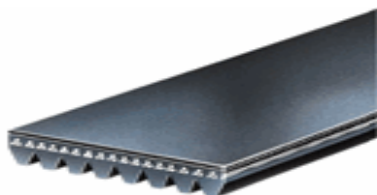

TOYOTA	CAMRY	V-6, 3.0 L	2006	-	2002
TOYOTA	SOLARA	V-6, 3.3 L	2005	-	2005
TOYOTA	CAMRY	V-6, 3.0 L	2005	-	2005
TOYOTA	SOLARA	V-6, 3.3 L	2006	-	2006
TOYOTA	SIENNA	V-6, 3.3 L	2005	-	2005
TOYOTA	SIENNA	V-6, 3.0 L	2003	-	2003
TOYOTA	SIENNA	V-6, 3.3 L	2006	-	2004

### K040353



CHRYSLER	CIRRUS	4 CIL, 2.4 L	2000	-	2000
CHRYSLER	CIRRUS	4 CIL, 2.0 L	2000	-	2000
SUBARU	FORESTER	4 CIL, 2.5 L	2007	-	2006
SUBARU	OUTBACK	4 CIL, 2.5 L	2007	-	2006
CHRYSLER	CIRRUS	4 CIL, 2.4 L	2005	-	2005
DODGE	STRATUS	4 CIL, 2.0 L	2006	-	1999
DODGE	STRATUS	4 CIL, 2.4 L	2006	-	2000
CHRYSLER	SEBRING	4 CIL, 2.4 L	2006	-	2005
SUBARU	IMPREZA	4 CIL, 2.5 L	2007	-	2006
HONDA	CR-V	4 CIL, 2.0 L	2001	-	1999

### K040350

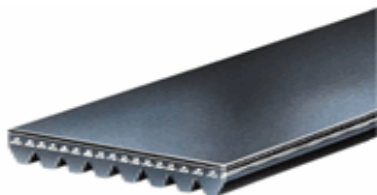

BMW	318I	4 CIL, 1.9 L	1998	-	1998
DODGE	NEON	4 CIL, 2.0 L	1999	-	1996
BMW	Z3	4 CIL, 1.9 L	1998	-	1998
BMW	318TI	4 CIL, 1.9 L	1999	-	1998
CHRYSLER	SEBRING	V-6, 2.5 L	1997	-	1996

### K040354

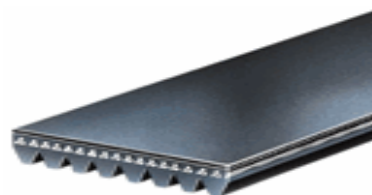

NISSAN	URVAN	4 CIL, 2.4 L	2008	-	2000
--------	-------	--------------	------	---	------

### K040355

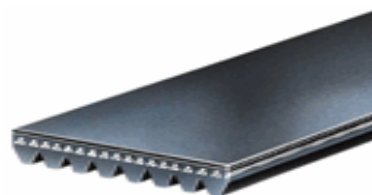



## Aplicación por Producto

CHRYSLER	SEBRING	V-6, 3.0 L	2006 - 2004
MITSUBISHI	ECLIPSE	V-6, 3.0 L	2005 - 2005
CHRYSLER	SEBRING	4 CIL, 2.4 L	1999 - 1997
CHRYSLER	SEBRING	4 CIL, 2.4 L	1996 - 1996
DODGE	STRATUS	V-6, 3.0 L	2002 - 2001
CHRYSLER	SEBRING	V-6, 3.0 L	2005 - 2005
MITSUBISHI	ECLIPSE	V-6, 3.0 L	2004 - 2004

### K040360

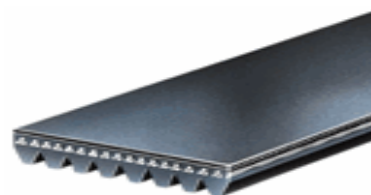

TOYOTA	YARIS	4 CIL, 1.5 L	2008 - 2010
NISSAN	URVAN	4 CIL, 2.4 L	2008 - 2000

### K040365

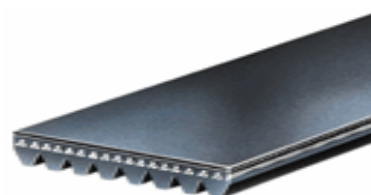

CHEVROLET	TRAILBLAZER	V-8, 5.3 L	2005 - 2005
CHEVROLET	TRACKER	V-6, 2.5 L	2004 - 2004
SUZUKI	GRAND VITARA	V-6, 2.5 L	2005 - 2004
CHEVROLET	TRAILBLAZER	V-8, 5.3 L	2007 - 2003
CHEVROLET	TRACKER	V-6, 2.5 L	2003 - 2002
SUZUKI	XL-7	V-6, 2.7 L	2006 - 2005

### K040370



HYUNDAI	H100 VAN/WAGON	4 CIL, 2.5 L DIESE	2009 - 2010
HYUNDAI	H100	4 CIL, 2.5 L DIESE	2008 - 2010

### K040372

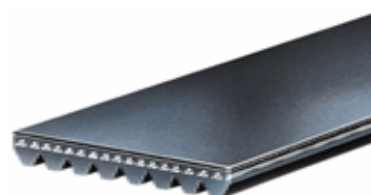

NISSAN	350Z	V-6, 3.5 L	2006 - 2003
NISSAN	PATHFINDER LE 4X2	V-6, 3.3 L	2000 - 1997
SUZUKI	GRAND VITARA	V-6, 2.7 L	2008 - 2006
CHEVROLET	TRACKER	4 CIL, 1.6 L	2000 - 1997
NISSAN	PATHFINDER	V-6, 3.5 L	2004 - 2001
INFINITI	Q45	V-8, 4.5 L	2003 - 2003

### K040355SF

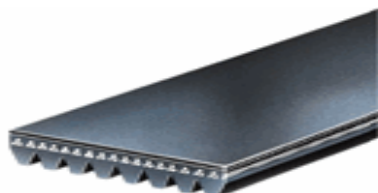

CHEVROLET	EXPRESS	V-8, 5.3 L	2009 - 2010
CHEVROLET	SUBURBAN	V-8, 6.0 L	2009 - 2010
CHEVROLET	AVALANCHE	V-8, 5.3 L	2009 - 2010
HUMMER	H2	V-8, 6.2 L	2009 - 2010
GMC	SIERRA	V-8, 5.3 L	2009 - 2010
CHEVROLET	SILVERADO	V-8, 5.3 L	2009 - 2010
GMC	YUKON	V-8, 6.2 L	2009 - 2010
GMC	SIERRA	V-8, 6.2 L	2009 - 2010
CHEVROLET	TAHOE	V-8, 5.3 L	2009 - 2010
CHEVROLET	SILVERADO	V-8, 4.8 L	2009 - 2010
CADILLAC	ESCALADE	V-8 6.2 L	2009 - 2010
CHEVROLET	SUBURBAN	V-8, 5.3 L	2009 - 2010
CHEVROLET	EXPRESS	V-8, 6.0 L	2009 - 2010

### K040358



NISSAN	TSURU	4 CIL, 1.6 L	2001 - 2010
MITSUBISHI	ENDEAVOR	V-6, 3.8 L	2004 - 2004
MITSUBISHI	GALANT	V-6, 3.8 L	2004 - 2004
MITSUBISHI	ENDEAVOR	V-6, 3.8 L	2007 - 2005
NISSAN	TSURU	4 CIL, 1.6 L	2002 - 2008
MITSUBISHI	ECLIPSE	V-6, 3.8 L	2007 - 2006
MITSUBISHI	GALANT	V-6, 3.8 L	2007 - 2005

## Aplicación por Producto

INFINITI INFINITI Q45 V-8, 4.5 L 2003 - 2002

**K040381**

**K040374SF**

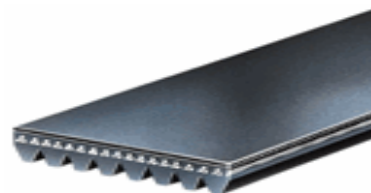
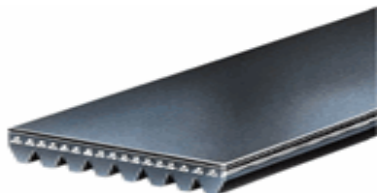

DODGE NITRO V-6, 4.0 L 2009 - 2010

CHRYSLER SEBRING V-6, 2.5 L 1997 - 1996  
DODGE STRATUS V-6, 2.5 L 2001 - 1998

**K040378**



**K040382**

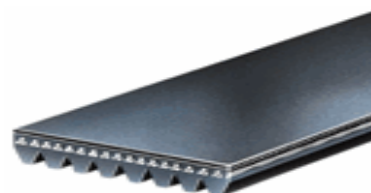

CHEVROLET	SILVERADO	V-8, 6.0 L	2007 - 2000
CHEVROLET	AVALANCHE	V-8, 5.3 L	2007 - 2008
CHEVROLET	TAHOE	V-8, 5.3 L	2007 - 2008
CHEVROLET	AVALANCHE	V-8, 5.3 L	2006 - 2005
CHEVROLET	SUBURBAN	V-8, 5.3 L	2007 - 2008
CADILLAC	ESCALADE	V-8 6.2 L	2008 - 2008
CHEVROLET	SILVERADO	V-8, 4.8 L	2007 - 2008
GMC	YUKON	V-8, 6.2 L	2008 - 2007
HUMMER	H2	V-8, 6.0 L	2007 - 2005
CHEVROLET	SUBURBAN	V-8, 6.0 L	2002 - 2003
HUMMER	H2	V-8, 6.2 L	2008 - 2008
PONTIAC	MATIZ G2	4 CIL, 1.0 L	2008 - 2009
CADILLAC	ESCALADE	V-8, 6.2 L	2007 - 2007
CHEVROLET	EXPRESS	V-8, 5.3 L	2007 - 2008
GMC	SIERRA	V-8, 6.2 L	2008 - 2007
CADILLAC	ESCALADE	V-8, 6.0 L	2006 - 2002
CADILLAC	ESCALADE	V-8, 6.0 L	2005 - 2005
CHEVROLET	SILVERADO	V-8, 5.3 L	2007 - 2008
CADILLAC	ESCALADE	V-8, 5.3 L	2004 - 2002
CHEVROLET	SONORA	V-8, 5.3 L	2003 - 2003
CHEVROLET	EXPRESS	V-8, 6.0 L	2007 - 2008
GMC	YUKON	V-8, 5.3 L	2008 - 2007
CHEVROLET	TAHOE	V-8, 4.8 L	2007 - 2006

DODGE STRATUS V-6, 2.5 L 2000 - 1999  
CHRYSLER SEBRING V-6, 2.5 L 2000 - 1998

**K040384**

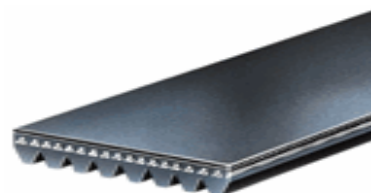

CHRYSLER SEBRING V-6, 2.5 L 1997 - 1996

**K040385**

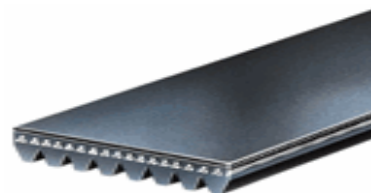

HYUNDAI H100 4 CIL, 2.4 L 2005 - 2004

**K040388**

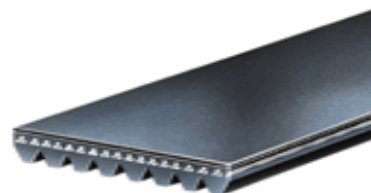

## Aplicación por Producto

DODGE	STRATUS	V-6, 2.7 L	2002 - 2001
MITSUBISHI	OUTLANDER	V-6, 3.0 L	2007 - 2008

### K040400

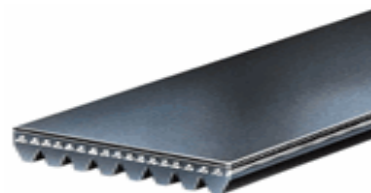

### K040390

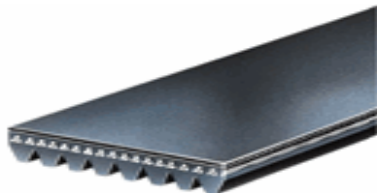

DODGE	VAN 1000	4 CIL, 2.4 L	2008 - 2010
-------	----------	--------------	-------------

### K040395

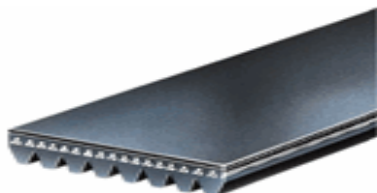

MITSUBISHI	MONTERO SPORT	V-6, 3.5 L	2004 - 2004
------------	---------------	------------	-------------

### K040398

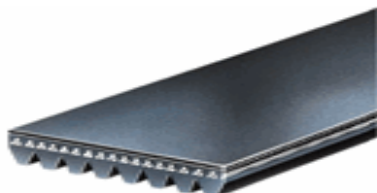

HONDA	CIVIC	4 CIL, 1.7 L	2004 - 2004
CHEVROLET	CORVETTE	V-8, 6.0 L	2007 - 2006
CHEVROLET	CORVETTE	V-8, 6.0 L	2005 - 2005
HONDA	CIVIC	4 CIL, 1.7 L	2005 - 2001
CHEVROLET	SUBURBAN	V-8, 8.1 L	2006 - 2003

### K040399

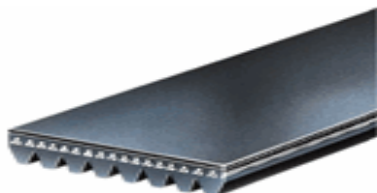

INFINITI	INFINITI Q45	V-8, 4.1 L	2001 - 1999
----------	--------------	------------	-------------

CHEVROLET	SILVERADO	V-8, 8.1 L	2007 - 2001
NISSAN	TSURU	4 CIL, 1.6 L	2003 - 2010
NISSAN	MAXIMA	V-6, 3.0 L	2004 - 2004
NISSAN	TSURU	4 CIL, 1.6 L	2001 - 2008
CHEVROLET	TRACKER	V-6, 2.5 L	2004 - 2004
CHEVROLET	AVALANCHE	V-8, 8.1 L	2002 - 2002
CHEVROLET	SUBURBAN	V-8, 8.1 L	2002 - 2002
INFINITI	INFINITI Q45	V-8, 4.1 L	2000 - 1998
SUZUKI	GRAND VITARA	V-6, 2.5 L	2005 - 2004
CHEVROLET	TRACKER	V-6, 2.5 L	2003 - 2002

### K040405

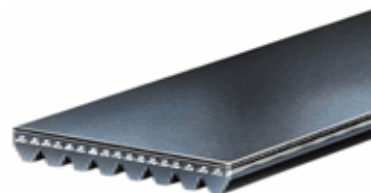

NISSAN	QUEST	V-6, 3.0 L	1998 - 1997
NISSAN	QUEST	V-6, 3.3 L	2001 - 1998
NISSAN	QUEST	6 CIL, 3.3 L	2002 - 2002

### K040410

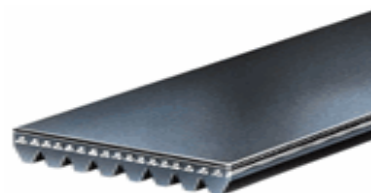

CHEVROLET	CAMARO Z28	V-8, 5.7 L	2000 - 2000
PONTIAC	TRANS AM FIREBIRD	V-8, 5.7 L	2001 - 1998
PONTIAC	FIREBIRD TRANS AM	V-8, 5.7 L	2002 - 1998
CHEVROLET	CAMARO Z28	V-8, 5.7 L	2002 - 1998

### K040413

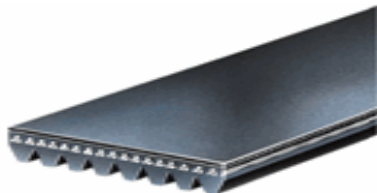

TOYOTA	4 RUNNER	V-6, 3.4 L	2002	-	2002
--------	----------	------------	------	---	------

### K040425

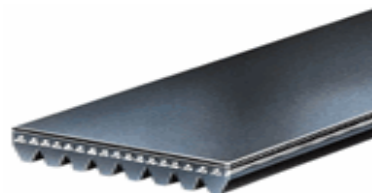

CHEVROLET	TRACKER	V-6, 2.5 L	2003	-	2002
SUZUKI	GRAND VITARA	V-6, 2.5 L	2005	-	2004
CHEVROLET	TRACKER	V-6, 2.5 L	2004	-	2004

### K040415

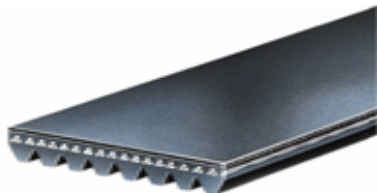

HYUNDAI	H100 VAN/WAGON	4 CIL, 2.5 L DIESE2009	-	2010	
HONDA	ACCORD	4 CIL, 2.3 L	2000	-	1999
HYUNDAI	H100	4 CIL, 2.5 L DIESE2008	-	2010	

### K040430

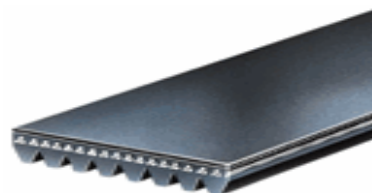

PONTIAC	G8	V8, 6.0 L	2009	-	2009
TOYOTA	HILUX	4 CIL, 2.7L	2006	-	2003
SUZUKI	GRAND VITARA	V-6, 2.7 L	2008	-	2006
SUZUKI	XL-7	V-6, 2.7 L	2006	-	2005

### K040418

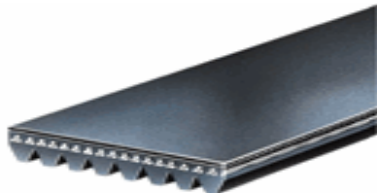

HONDA	ACCORD	4 CIL, 2.3 L	2002	-	1999
-------	--------	--------------	------	---	------

### K040438

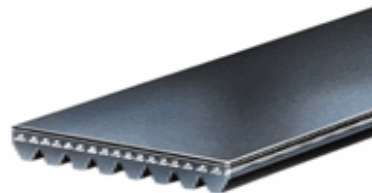

HONDA	ACCORD	V-6, 3.0 L	2002	-	1999
HONDA	ODYSSEY	V-6, 3.5 L	2004	-	1999
HONDA	PILOT	V-6, 3.5 L	2004	-	2003

### K040420

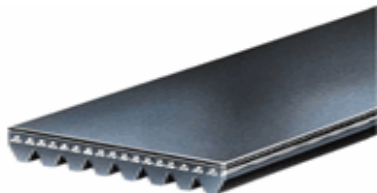

HONDA	ACCORD	4 CIL, 2.3 L	1998	-	1998
CHEVROLET	CORVETTE	V-8, 5.7 L	2004	-	1997
TOYOTA	4 RUNNER	V-6, 3.4 L	2002	-	2002
NISSAN	MICRA	4 CIL, 1.4 L	2008	-	2004
HYUNDAI	H100 VAN/WAGON	4 CIL, 2.5 L DIESE2009	-	2010	
HYUNDAI	H100	4 CIL, 2.5 L DIESE2008	-	2010	

### K040440

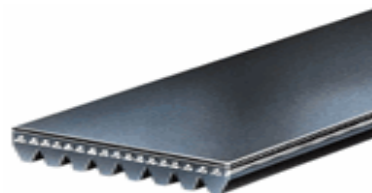

HONDA	ACCORD	V-6, 3.0 L	2000	-	1998
DODGE	NEON	4 CIL, 2.0 L	2000	-	2000
DODGE	NEON	4 CIL, 2.0 L	2001	-	2001
HONDA	ODYSSEY	V-6, 3.5 L	2000	-	1999

### K040460

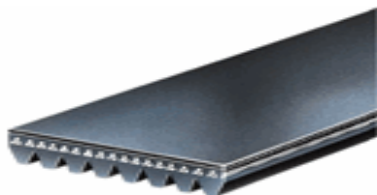

NISSAN	QUEST	6 CIL, 3.3 L	2002	-	2002
NISSAN	QUEST	V-6, 3.3 L	2001	-	1999
NISSAN	QUEST	V-6, 3.0 L	1998	-	1998

### K040490

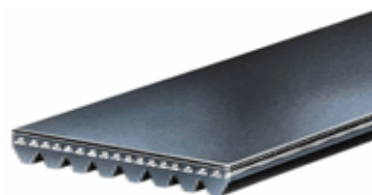

NISSAN	URVAN	4 CIL, 2.4 L	2008	-	2005
--------	-------	--------------	------	---	------

### K040510

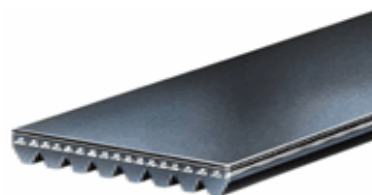

CHRYSLER	PT CRUISER	4 CIL, 2.4 L	2005	-	2004
CHRYSLER	PT CRUISER	4 CIL, 2.4 L	2007	-	2010

### K040465

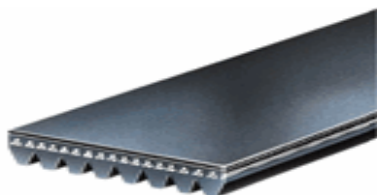

TOYOTA	YARIS	4 CIL, 1.5 L	2008	-	2010
--------	-------	--------------	------	---	------

### K040514

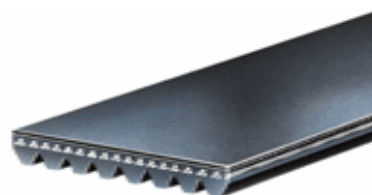

DODGE	NEON	4 CIL, 2.0 L	2001	-	2000
-------	------	--------------	------	---	------

### K040470

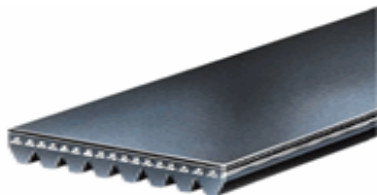

NISSAN	QUEST	V-6, 3.0 L	1998	-	1997
NISSAN	QUEST	V-6, 3.3 L	2000	-	1998

### K040517

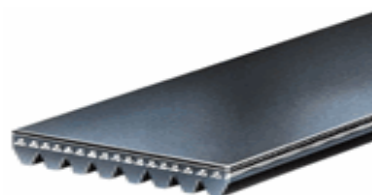

DODGE	NEON	4 CIL, 2.0 L	2006	-	2000
CHRYSLER	PT CRUISER	4 CIL, 2.4 L	2001	-	2000

### K040488

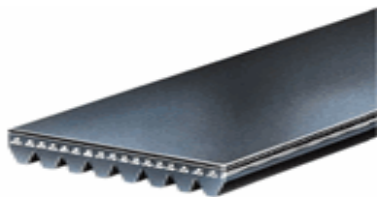

TOYOTA	CAMRY	4 CIL, 2.5 L	2010	-	2011
--------	-------	--------------	------	---	------

### K040520

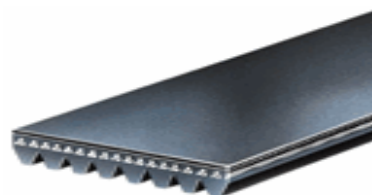



## Aplicación por Producto

DODGE	NEON	4 CIL, 2.0 L	2005	-	2005
-------	------	--------------	------	---	------

**K040630**

**K040529**

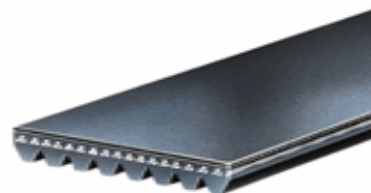
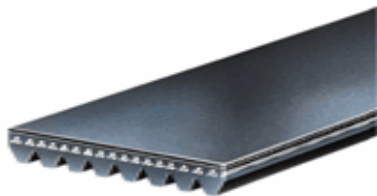

NISSAN	XTERRA	V-6, 3.3 L	2002	-	2000
NISSAN	FRONTIER	V-6, 3.3 L	2004	-	1999

HONDA	CIVIC HIBRIDO	4 CIL, 1.3 L	2007	-	2010
-------	---------------	--------------	------	---	------

**K050264SF**

**K040530**

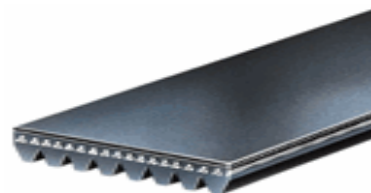
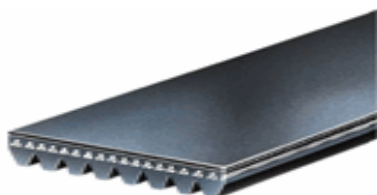

NISSAN	FRONTIER	V-6, 3.3 L	2001	-	2001
NISSAN	XTERRA	V-6, 3.3 L	2000	-	2000

MAZDA	MAZDA 3	4 CIL, 2.0 L	2006	-	2008
MAZDA	MAZDA 3	4 CIL, 2.3 L	2006	-	2009

**K050272SF**

**K040551**

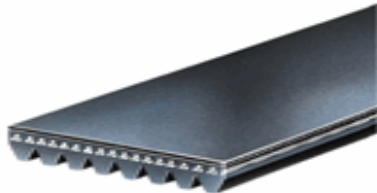

CHRYSLER	PT CRUISER	4 CIL, 2.4 L	2007	-	2010
DODGE	NEON	4 CIL, 2.4 L	2006	-	2004
DODGE	NEON	4 CIL, 2.4 L	2005	-	2005
CHRYSLER	PT CRUISER	4 CIL, 2.4 L	2005	-	2004

MAZDA	MAZDA 3	4 CIL, 2.3 L	2006	-	2009
-------	---------	--------------	------	---	------

**K050275**

**K040560**

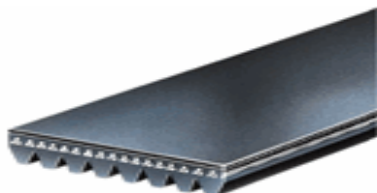

CHRYSLER	PT CRUISER	4 CIL, 2.4 L	2002	-	2000
----------	------------	--------------	------	---	------

MAZDA	MAZDA 3	4 CIL, 2.0 L	2008	-	2006
-------	---------	--------------	------	---	------

**K050290**



MG	TF	4 CIL, 1.8 L	2002	-	2005
----	----	--------------	------	---	------

## Aplicación por Producto

MG ZR 4 CIL, 1.8 L 2002 - 2005

### K050340

### K050316

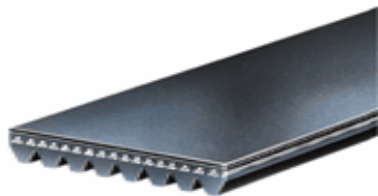

NISSAN	FRONTIER	V-6, 3.3 L	2004 - 1999
NISSAN	XTERRA	V-6, 3.3 L	2002 - 2000

### K050317

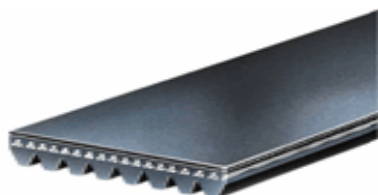

NISSAN	XTERRA	V-6, 3.3 L	2000 - 2000
NISSAN	FRONTIER	V-6, 3.3 L	2001 - 2001

### K050335

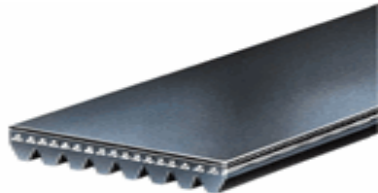

NISSAN	QUEST	6 CIL, 3.3 L	2002 - 2002
VOLVO	C30	5 CIL, 2.4 L	2009 - 2010
VOLVO	C30	5 CIL, 2.5 L	2009 - 2010
NISSAN	QUEST	V-6, 3.3 L	2001 - 1999
VOLVO	S40	5 CIL, 2.4 L	2006 - 2005

### K050336

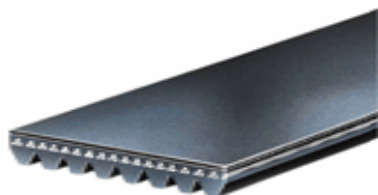

NISSAN	QUEST	V-6, 3.3 L	2000 - 1998
NISSAN	QUEST	V-6, 3.0 L	1998 - 1997

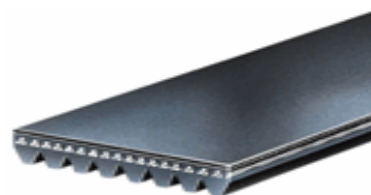

BMW	325CI	V-6, 2.5 L	2002 - 2002
BMW	525I	6 CIL, 2.5 L	2005 - 2001
BMW	330CI	6 CIL, 3.0 L	2003 - 2001
BMW	528I	V-6, 2.8 L	2000 - 1999
BMW	Z3	V-6, 2.5 L	2001 - 2001
BMW	530I	6 CIL, 3.0 L	2002 - 2002
BMW	323I	V-6, 2.5 L	2000 - 1999
BMW	328I	V-6, 2.8 L	2000 - 1999
BMW	Z3	V-6, 3.0 L	2001 - 2001
BMW	323CI	V-6, 2.5 L	2000 - 2000
BMW	325I	V-6, 2.5 L	2003 - 2001
BMW	325CI	V-6, 2.5 L	2005 - 2001
BMW	330XI	6 CIL, 3.0 L	2001 - 2001

### K050345

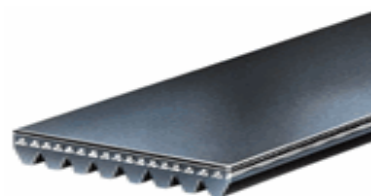

PONTIAC	G4	4 CIL, 2.2 L	2006 - 2006
CHEVROLET	CAVALIER	4 CIL, 2.2 L	2004 - 2003
PONTIAC	G4	4 CIL, 2.4 L	2006 - 2006
SUBARU	LEGACY	4 CIL, 2.5 L	2007 - 2006
PONTIAC	G5	4 CIL, 2.2 L	2008 - 2007
PONTIAC	G5	4 CIL, 2.4 L	2008 - 2007
SUBARU	FORESTER	4 CIL, 2.5 L	2007 - 2006
SUBARU	OUTBACK	4 CIL, 2.5 L	2007 - 2006
PONTIAC	SUNFIRE	4 CIL, 2.2 L	2003 - 2003
SUBARU	IMPREZA	4 CIL, 2.5 L	2007 - 2006

### K050350



CHEVROLET	VECTRA	4 CIL, 2.2 L	2005 - 2003
VOLVO	C30	5 CIL, 2.4 L	2008 - 2010

## Aplicación por Producto

VOLVO	S40	5 CIL, 2.4 L	2008	-	2005
VOLVO	S40	5 CIL, 2.5 L	2008	-	2007
VOLVO	C30	5 CIL, 2.5 L	2008	-	2010

### K050370

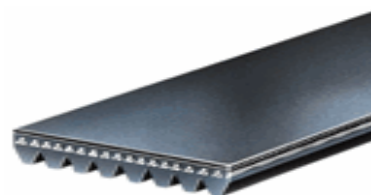

### K050355

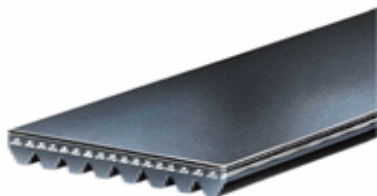

BMW	Z3	V-6, 2.8 L	2000	-	1998
HYUNDAI	VERNA	4 CIL, 1.5 L	2006	-	2004
VOLVO	S40	5 CIL, 2.4 L	2008	-	2007
BMW	528I	V-6, 2.8 L	1998	-	1998
BMW	328IS	V-6, 2.8 L	1999	-	1998
VOLVO	S40	5 CIL, 2.5 L	2008	-	2007
BMW	M3	V-6, 3.2 L	1999	-	1999
BMW	M	V-6, 3.2 L	2000	-	1999
BMW	Z3	V-6, 2.5 L	2000	-	1999
BMW	328I	V-6, 2.8 L	1998	-	1998
BMW	323IS	V-6, 2.5 L	1999	-	1998
VOLVO	C30	5 CIL, 2.4 L	2008	-	2008
VOLVO	C30	5 CIL, 2.5 L	2008	-	2008

DODGE	STRATUS	4 CIL, 2.4 L	2006	-	2001
CHEVROLET	CORSA	4 CIL, 1.4 L	2002	-	2003
FIAT	PALIO ADVENTURE	4 CIL, 1.6 L	2006	-	2003
CHEVROLET	CORSA	4 CIL, 1.8 L	2004	-	2003
CHRYSLER	SEBRING	4 CIL, 2.4 L	2006	-	2004
CHEVROLET	ASTRA	4 CIL, 1.8 L	2007	-	2000
CADILLAC	SRX	V-8, 4.6 L	2004	-	2004
CHEVROLET	ZAFIRA	4 CIL, 1.8 L	2003	-	2000
FIAT	PALIO	4 CIL, 1.6 L	2006	-	2003

### K050380



### K050365

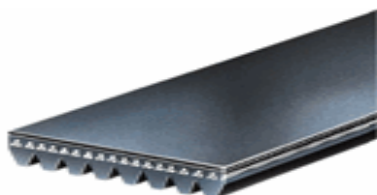

FAW	F4	4 CIL, 1.4 L	2008	-	2009
FAW	F5	4 CIL, 1.5 L	2008	-	2009

### K050385

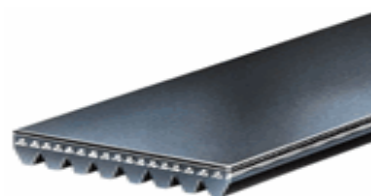

VOLKSWAGEN	BORA	5 CIL, 2.5 L	2008	-	2005
VOLKSWAGEN	BORA	5 CIL, 2.5 L	2009	-	2009
VOLKSWAGEN	BORA SPORTWAGEN	5 CIL, 2.5 L	2008	-	2008
VOLKSWAGEN	BORA SPORTWAGEN	5 CIL, 2.5 L	2009	-	2009

BMW	M5	V-8, 5.0 L	2003	-	2000
-----	----	------------	------	---	------

### K050368

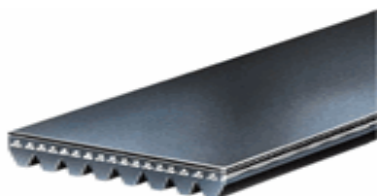

### K050395

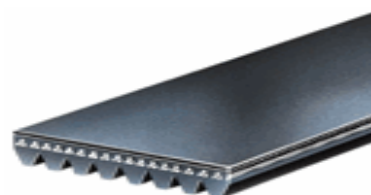

VOLKSWAGEN	BEETLE	5 CIL, 2.5 L	2009	-	2010
VOLKSWAGEN	BEETLE	5 CIL, 2.5 L	2008	-	2006

BMW	740IL	V-8, 4.4 L	1998	-	1998
BMW	540I	V-8, 4.4 L	2001	-	1998
BMW	740I	V-8, 4.4 L	2001	-	1998

## Aplicación por Producto

### K050396

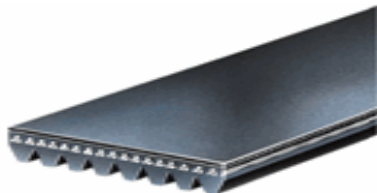

BMW	740IL	V-8, 4.4 L	2001 - 1999
LAND ROVER	RANGE ROVER	V-8, 4.4 L	2005 - 2003
BMW	X5	V-8, 4.4 L	2000 - 2000
BMW	740I	V-8, 4.4 L	2001 - 2000

### K050400

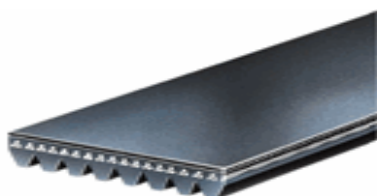

PONTIAC	G5	4 CIL, 2.2 L	2008 - 2007
CHEVROLET	HHR	4 CIL, 2.4 L	2007 - 2006
CHEVROLET	CAVALIER	4 CIL, 2.2 L	2005 - 2005
PONTIAC	G4	4 CIL, 2.4 L	2006 - 2006
PONTIAC	G5	4 CIL, 2.4 L	2008 - 2007
PONTIAC	SUNFIRE	4 CIL, 2.2 L	2005 - 2005
PONTIAC	SUNFIRE	4 CIL, 2.2 L	2004 - 2002
CHEVROLET	CAVALIER	4 CIL, 2.2 L	2004 - 2002
PONTIAC	G4	4 CIL, 2.2 L	2006 - 2006

### K050402

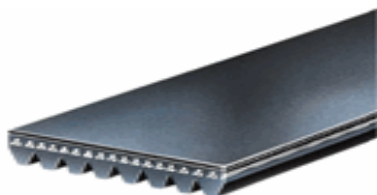

CHEVROLET	MALIBU	4 CIL, 2.4 L	2008 - 2010
PONTIAC	SOLSTICE	4 CIL, 2.4 L	2008 - 2006
CHEVROLET	MALIBU	4 CIL, 2.2 L	2007 - 2005

### K050405

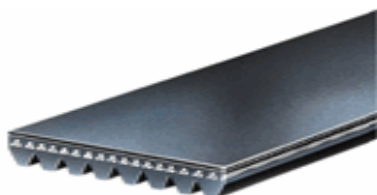

CHEVROLET	HHR	4 CIL, 2.4 L	2008 - 2010
PONTIAC	GRAND AM	4 CIL, 2.2 L	2003 - 2002
CHEVROLET	VECTRA	4 CIL, 2.2 L	2005 - 2003
SAAB	9-3	4 CIL, 2.0 L	2007 - 2004
CHEVROLET	MALIBU	4 CIL, 2.2 L	2004 - 2004

### K050407

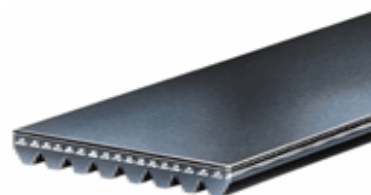

CHEVROLET	CAPTIVA	4 CIL, 2.4 L	2008 - 2010
-----------	---------	--------------	-------------

### K050418

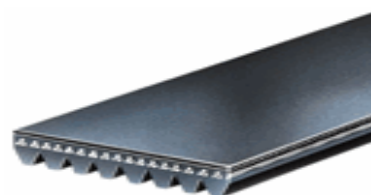

VOLKSWAGEN	BORA SPORTWAGEN	5 CIL, 2.5 L	2009 - 2009
VOLKSWAGEN	BORA SPORTWAGEN	5 CIL, 2.5 L	2008 - 2008
VOLKSWAGEN	BORA	5 CIL, 2.5 L	2008 - 2005
VOLKSWAGEN	BORA	5 CIL, 2.5 L	2009 - 2009

### K050425



ALFA ROMEO	ALFA 159	4 CIL, 2.2 L	2007 - 2005
MITSUBISHI	LANCER	4 CIL, 2.0 L	2007 - 2005

### K050429

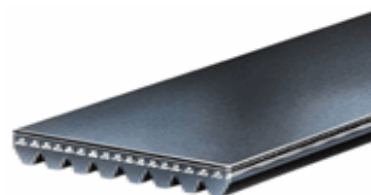

DODGE	STRATUS	4 CIL, 2.4 L	2002 - 2001
-------	---------	--------------	-------------

### K050433

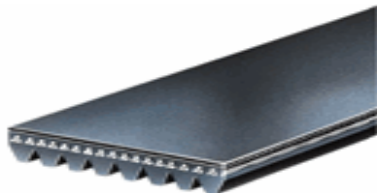

CHEVROLET	P-30	V-8, 5.7 L	1996	-	1996
-----------	------	------------	------	---	------

### K050448

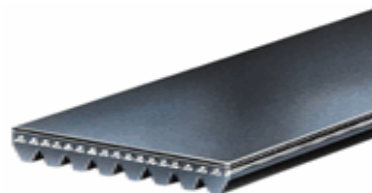

HONDA	FIT	4 CIL, 1.5 L	2009	-	2010
HONDA	CITY	4 CIL, 1.5 L	2010	-	2010
AUDI	A8	V8, 4.2 L	2008	-	2009

### K050435

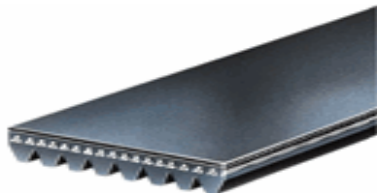

NISSAN	PLATINA	4 CIL, 1.6 L	2008	-	2010
RENAULT	KANGOO EXPRESS	4 CIL, 1.6 L	2008	-	2009
RENAULT	KANGOO	4 CIL, 1.6 L	2008	-	2010
RENAULT	CLIO	4 CIL, 1.6 L	2008	-	2009
NISSAN	APRIO	4 CIL, 1.6 L	2008	-	2010

### K050450

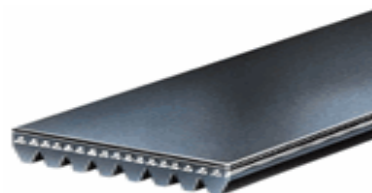

MG	ZR	4 CIL, 1.8 L	2002	-	2005
HONDA	FIT	4 CIL, 1.5 L	2008	-	2006

### K050440

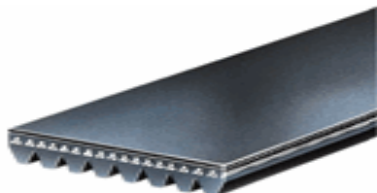

AUDI	Q7	V-8, 4.2 L	2007	-	2007
VOLKSWAGEN	TOUAREG	V-8, 4.2 L	2007	-	2007

### K050455

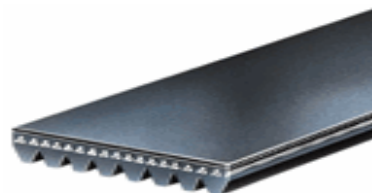

FIAT	PANDA	4 CIL, 1.2 L	2008	-	2010
FIAT	GRANDE PUNTO	4 CIL, 1.4 L	2009	-	2010
FIAT	BRAVO	4 CIL, 1.4 L	2009	-	2010

### K050446

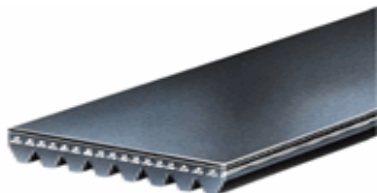

RENAULT	TRAFIC	4 CIL, 1.9 L DIESE2008	-	-	2010
MITSUBISHI	MONTERO SPORT	V-6, 3.5 L	2004	-	2004

### K050459

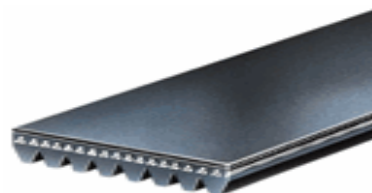

MG	ZR	4 CIL, 1.8 L	2002	-	2005
----	----	--------------	------	---	------



### K050470

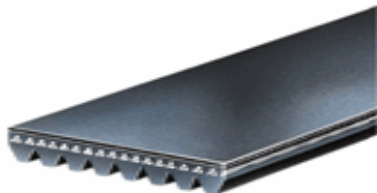

MG	TF	4 CIL, 1.8 L	2002 - 2005
----	----	--------------	-------------

### K050505

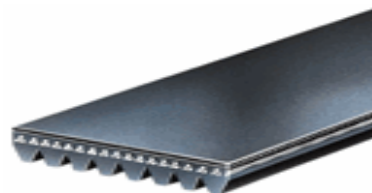

NISSAN	PATHFINDER	V-6, 3.3 L	2000 - 1998
--------	------------	------------	-------------

### K050474

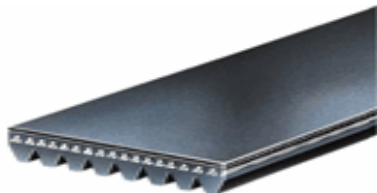

CHEVROLET	CAVALIER	4 CIL, 2.4 L	1998 - 1996
PONTIAC	GRAND AM	4 CIL, 2.4 L	1999 - 1998
PONTIAC	SUNFIRE	4 CIL, 2.4 L	1999 - 1996
CHEVROLET	MALIBU	4 CIL, 2.4 L	1998 - 1997

### K050510

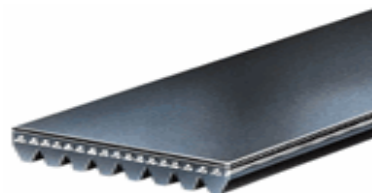

VOLKSWAGEN	PASSAT	4 CIL, 1.8 L	2004 - 1999
AUDI	A4	4 CIL, 1.8 L	2002 - 1998
VOLKSWAGEN	PASSAT	4 CIL, 1.8 L	2005 - 2005
MITSUBISHI	LANCER	4 CIL, 2.0 L	2007 - 2007

### K050478

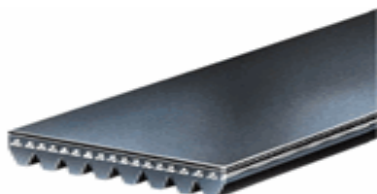

CHEVROLET	CAVALIER Z24	4 CIL, 2.4 L	2002 - 1998
CHEVROLET	CAVALIER	4 CIL, 2.4 L	1999 - 1999
PONTIAC	GRAND AM	4 CIL, 2.4 L	2001 - 1998
CHEVROLET	ZAFIRA	4 CIL, 1.8 L	2003 - 2000
CHEVROLET	ASTRA	4 CIL, 1.8 L	2007 - 2000
CHEVROLET	CORSA	4 CIL, 1.4 L	2002 - 2003
PONTIAC	SUNFIRE	4 CIL, 2.4 L	2002 - 1999

### K050538

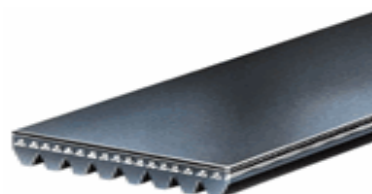

CHRYSLER	SEBRING	4 CIL, 2.4 L	2006 - 2004
DODGE	STRATUS	4 CIL, 2.4 L	2006 - 2001

### K050486

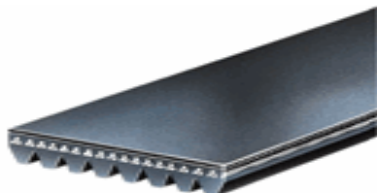

NISSAN	XTERRA	V-6, 3.3 L	2002 - 2000
NISSAN	FRONTIER	V-6, 3.3 L	2004 - 1999

### K050570

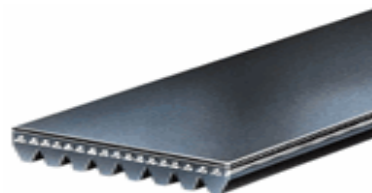

CHEVROLET	ASTRA	4 CIL, 1.8 L	2008 - 2009
SUZUKI	SWIFT	4 CIL, 1.6 L	2009 - 2009

## Aplicación por Producto

**K050586**

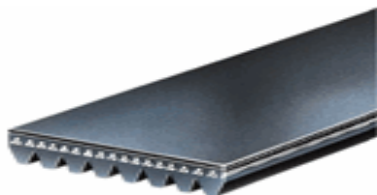

CHEVROLET	TRACKER	4 CIL, 2.0 L	2003	-	1999
-----------	---------	--------------	------	---	------

**K050658**

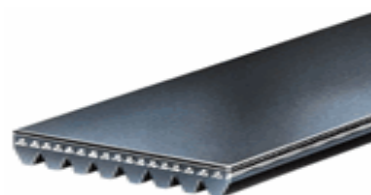

SUZUKI	SX4	4 CIL, 2.0 L	2008	-	2009
--------	-----	--------------	------	---	------

CHRYSLER	SEBRING	V-6, 2.5 L	2000	-	1996
----------	---------	------------	------	---	------

**K050609**

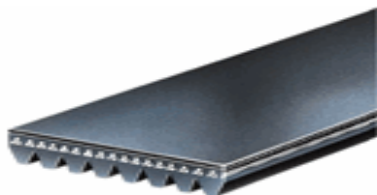

**K050660**



SUZUKI	AERIO	4 CIL, 2.3 L	2006	-	2005
--------	-------	--------------	------	---	------

CHEVROLET	ASTRA	4 CIL, 1.8 L	2008	-	2009
-----------	-------	--------------	------	---	------

CHEVROLET	TRACKER	4 CIL, 2.0 L	2003	-	1999
-----------	---------	--------------	------	---	------

**K050618**

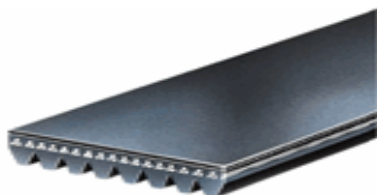

**K050688**

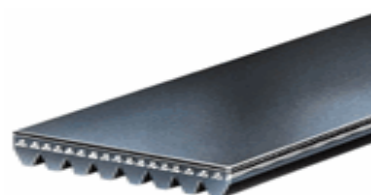

SUZUKI	SWIFT	4 CIL, 1.6 L	2009	-	2009
--------	-------	--------------	------	---	------

RENAULT	CLIO	4 CIL, 1.6 L	2008	-	2009
---------	------	--------------	------	---	------

NISSAN	APRIO	4 CIL, 1.6 L	2008	-	2010
--------	-------	--------------	------	---	------

NISSAN	PLATINA	4 CIL, 1.6 L	2008	-	2010
--------	---------	--------------	------	---	------

RENAULT	MEGANE	4 CIL, 2.0 L	2003	-	2001
---------	--------	--------------	------	---	------

RENAULT	KANGOO	4 CIL, 1.6 L	2008	-	2010
---------	--------	--------------	------	---	------

RENAULT	KANGOO EXPRESS	4 CIL, 1.6 L	2008	-	2009
---------	----------------	--------------	------	---	------

RENAULT	SCENIC	4 CIL, 2.0 L	2003	-	2001
---------	--------	--------------	------	---	------

**K050630**

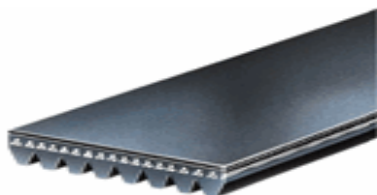

**K050690**

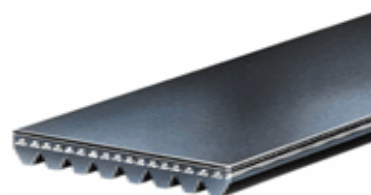

PONTIAC	SUNFIRE	4 CIL, 2.2 L	2002	-	1998
---------	---------	--------------	------	---	------

CHEVROLET	CAVALIER	4 CIL, 2.2 L	2002	-	1998
-----------	----------	--------------	------	---	------

**K050650**

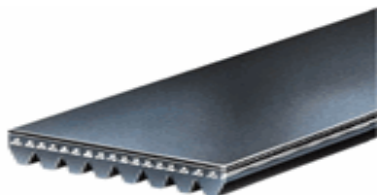

CHEVROLET	CORSA	4 CIL, 1.8 L	2008	-	2009
-----------	-------	--------------	------	---	------

CHEVROLET	TORNADO	4 CIL, 1.8 L	2008	-	2009
-----------	---------	--------------	------	---	------

CHEVROLET	TORNADO	4 CIL, 1.8 L	2007	-	2003
-----------	---------	--------------	------	---	------

CHEVROLET	MERIVA	4 CIL, 1.8 L	2007	-	2005
-----------	--------	--------------	------	---	------

FIAT	PALIO	4 CIL, 1.8 L	2008	-	2006
------	-------	--------------	------	---	------

## Aplicación por Producto

CHEVROLET	MERIVA	4 CIL, 1.8 L	2008	-	2008
FIAT	PALIO ADVENTURE	4 CIL, 1.8 L	2008	-	2006
CHEVROLET	CORSA	4 CIL, 1.8 L	2005	-	2005

SEAT	CORDOBA	4 CIL, 1.6 L	2007	-	2008
SEAT	IBIZA	4 CIL, 1.6 L	2007	-	2009

### K060297

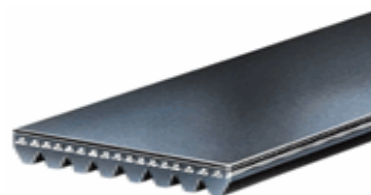
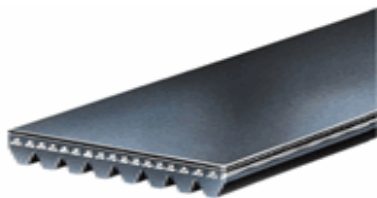

VOLKSWAGEN	POLO	4 CIL, 1.6 L	2007	-	2005
VOLKSWAGEN	POLO	4 CIL, 1.6 L	2004	-	2003

### K060325

CHEVROLET	CORSA	4 CIL, 1.8 L	2008	-	2009
CHEVROLET	CORSA	4 CIL, 1.8 L	2005	-	2005
CHEVROLET	MERIVA	4 CIL, 1.8 L	2007	-	2005
FIAT	PALIO ADVENTURE	4 CIL, 1.8 L	2008	-	2006
CHEVROLET	TORNADO	4 CIL, 1.8 L	2008	-	2009
CHEVROLET	MERIVA	4 CIL, 1.8 L	2008	-	2008
CHEVROLET	TORNADO	4 CIL, 1.8 L	2007	-	2003
FIAT	PALIO	4 CIL, 1.8 L	2008	-	2006

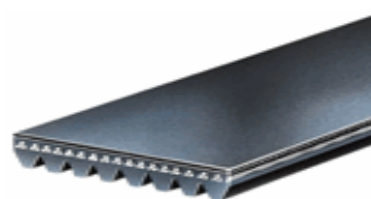

NISSAN	SENTRA	4 CIL, 1.8 L	2006	-	2005
NISSAN	ALMERA	4 CIL, 1.8 L	2006	-	2003

### K060330

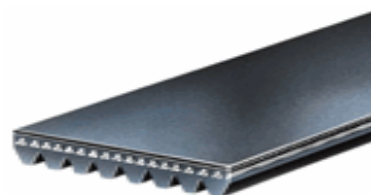
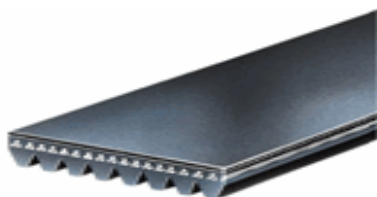

CHEVROLET	CAVALIER	4 CIL, 2.2 L	2002	-	1998
PONTIAC	SUNFIRE	4 CIL, 2.2 L	2002	-	1998

INFINITI	INFINITI Q45	V-8, 4.1 L	1998	-	1998
NISSAN	SENTRA	4 CIL, 1.8 L	2003	-	2003

### K060331

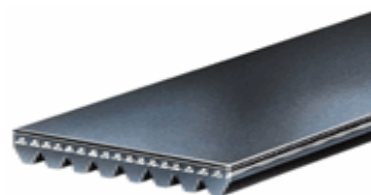
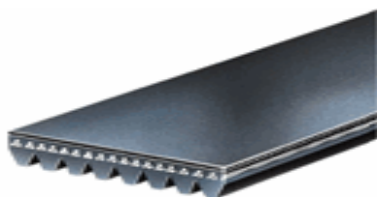

PEUGEOT	207	4 CIL, 1.6 L	2008	-	2009
---------	-----	--------------	------	---	------

INFINITI	INFINITI Q45	V-8, 4.1 L	2001	-	1999
----------	--------------	------------	------	---	------

### K060295

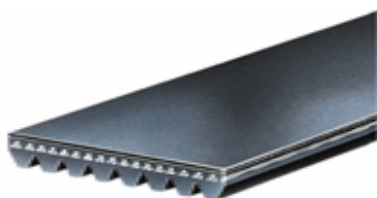

INFINITI	INFINITI Q45	V-8, 4.1 L	2001	-	1998
----------	--------------	------------	------	---	------

### K060338

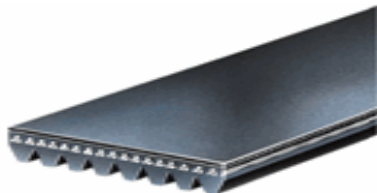

HONDA	CIVIC	4 CIL, 1.7 L	2005 - 2003
HONDA	CIVIC	4 CIL, 1.7 L	2004 - 2004

### K060374

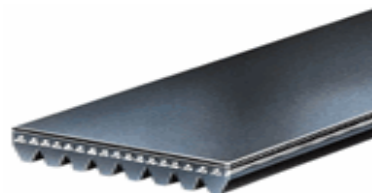

TOYOTA	SIENNA	V-6, 3.0 L	2003 - 2003
--------	--------	------------	-------------

### K060355

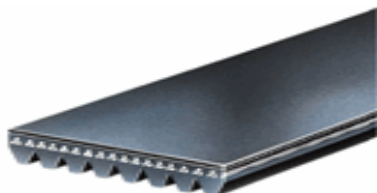

VOLKSWAGEN	DERBY	4 CIL, 1.8 L	2008 - 2006
PEUGEOT	207	4 CIL, 1.6 L TURBQ2008	- 2009
CHEVROLET	TIGRA	4 CIL, 1.6 L	1999 - 2000
MINI	COOPER	4 CIL, 1.6 L	2007 - 2008
VOLKSWAGEN	JETTA	4 CIL, 1.9 L DIESE2001	- 2000
VOLKSWAGEN	DERBY	4 CIL, 1.8 L	2005 - 2005

### K060380

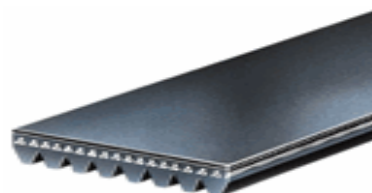

SEAT	LEON	4 CIL, 2.0 L	2007 - 2006
SEAT	ALTEA	4 CIL, 2.0 L	2008 - 2006
SEAT	TOLEDO	4 CIL, 2.0 L	2007 - 2006

### K060363

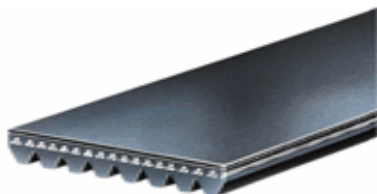

SEAT	IBIZA	4 CIL, 2.0 L	2003 - 2009
SEAT	CORDOBA	4 CIL, 2.0 L	2003 - 2007

### K060385

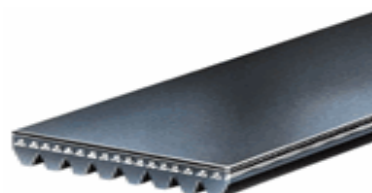

VOLKSWAGEN	BEETLE	4 CIL, 2.0 L	2000 - 2000
VOLKSWAGEN	DERBY	4 CIL, 1.8 L	2004 - 2003
VOLKSWAGEN	DERBY	4 CIL, 2.0 L	2004 - 2003
VOLKSWAGEN	GTI	4 CIL, 2.0 L	2000 - 1999
VOLKSWAGEN	VW VAN	4 CIL, 1.8 L	2005 - 2005
VOLKSWAGEN	VW VAN	4 CIL, 1.6 L	2004 - 2003
VOLKSWAGEN	VW VAN	4 CIL, 1.8 L	2006 - 2006

### K060365

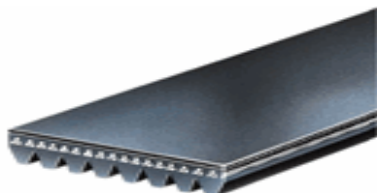

TOYOTA	MATRIX	4 CIL, 1.8 L	2009 - 2010
VOLKSWAGEN	COMBI	4 CIL, 1.8 L	2001 - 1996
VOLKSWAGEN	PANEL	4 CIL, 1.8 L	2001 - 1996
TOYOTA	COROLLA	4 CIL, 1.8 L	2009 - 2010
VOLKSWAGEN	DERBY	4 CIL, 1.8 L	2001 - 1999

### K060388

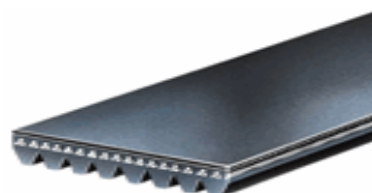

HONDA	CIVIC	4 CIL, 1.7 L	2005 - 2001
HONDA	CIVIC	4 CIL, 1.7 L	2004 - 2004

### K060393

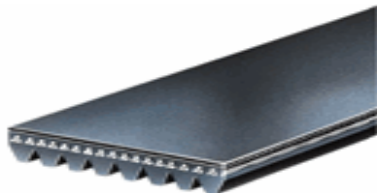

FORD	F-250 SUPER DUTY	V-8, 6.4 L DIESEL 2008	-	2010
FORD	F-550 SUPER DUTY	V-8, 6.4 L DIESEL 2008	-	2010
FORD	F-450 SUPER DUTY	V-8, 6.4 L DIESEL 2008	-	2010

### K060407

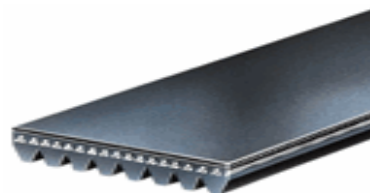

TOYOTA	CAMRY	V-6, 3.0 L	2002	-	2002
--------	-------	------------	------	---	------

### K060400

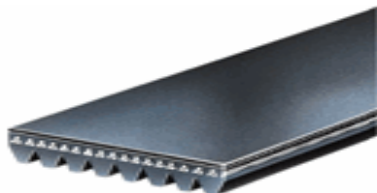

PEUGEOT	407	4 CIL, 2.2 L	2008	-	2005
---------	-----	--------------	------	---	------

### K060405

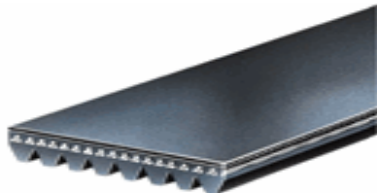

NISSAN	SENTRA	4 CIL, 2.0 L	2002	-	2000
--------	--------	--------------	------	---	------

### K060406

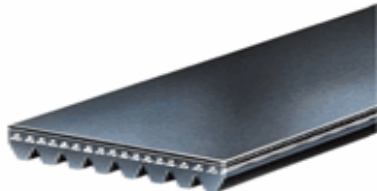

SEAT	CORDOBA	4 CIL, 2.0 L	2003	-	2007
VOLKSWAGEN	POLO	4 CIL, 2.0 L	2005	-	2003
SEAT	IBIZA	4 CIL, 2.0 L	2003	-	2009

### K060408

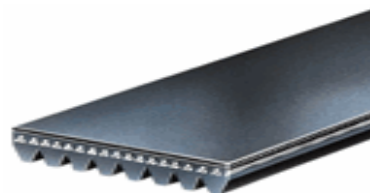

NISSAN	XTERRA	4 CIL, 2.4 L	2001	-	2001
VOLKSWAGEN	JETTA	4 CIL, 2.0 L	2000	-	1996
TOYOTA	CAMRY	V-6, 3.0 L	2005	-	2005
TOYOTA	SOLARA	V-6, 3.3 L	2005	-	2005
MINI	COOPER	4 CIL, 1.6 L	2006	-	2007
NISSAN	SENTRA	4 CIL, 2.0 L	2001	-	1998
VOLKSWAGEN	GOLF	4 CIL, 2.0 L	2000	-	1996
TOYOTA	CAMRY	V-6, 3.0 L	2006	-	2003
TOYOTA	SIENNA	V-6, 3.3 L	2005	-	2005
NISSAN	TSURU	4 CIL, 2.0 L	1996	-	1999
NISSAN	LUCCINO	4 CIL, 2.0 L	1998	-	1996
TOYOTA	SIENNA	V-6, 3.3 L	2006	-	2004
TOYOTA	SIENNA	V-6, 3.0 L	2003	-	2003
TOYOTA	SOLARA	V-6, 3.3 L	2006	-	2006

### K060413

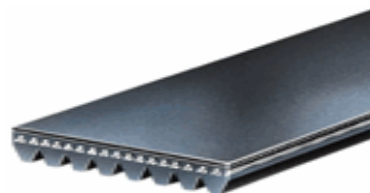

FORD	IKON	4 CIL, 1.6 L	2003	-	2003
FORD	COURIER	4 CIL, 1.6 L	2006	-	2007
FORD	FIESTA	4 CIL, 1.6 L	2008	-	2010
FORD	KA	4 CIL, 1.6 L	2003	-	2001



## Aplicación por Producto

### K060415

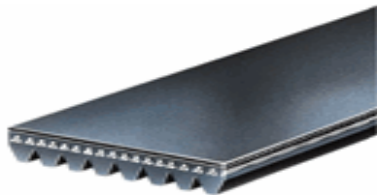

CHRYSLER	CONCORDE	V-6, 2.7 L	2000	-	1998
VOLKSWAGEN	LUPO	4 CIL, 1.6 L	2008	-	2004
VOLKSWAGEN	CROSSFOX	4 CIL, 1.6 L	2008	-	2005
VOLKSWAGEN	BORA	4 CIL, 2.0 L DIESE	2009	-	2010
NISSAN	PATHFINDER	V-6, 3.3 L	2000	-	1998
NISSAN	MURANO	V-6, 3.5 L	2008	-	2007

FORD	RANGER F-100	4 CIL, 2.3 L	1998	-	1996
VOLKSWAGEN	JETTA	4 CIL, 2.0 L	2008	-	2010
AUDI	A3	4 CIL, 2.0 L	2007	-	2008
SEAT	TOLEDO	4 CIL, 2.0 L	2007	-	2006
VOLKSWAGEN	JETTA	4 CIL, 1.9 L DIESE	2007	-	2006
VOLKSWAGEN	BORA	4 CIL, 1.9 L DIESE	2007	-	2007
HONDA	ACCORD	4 CIL, 2.3 L	1998	-	1998
VOLKSWAGEN	PASSAT	4 CIL, 2.0 L	2008	-	2006
FORD	RANGER	4 CIL, 2.3 L	1997	-	1996
VOLKSWAGEN	GTI	4 CIL, 2.0 L TURB	2008	-	2007
VOLKSWAGEN	GLI	4 CIL, 2.0 L TURB	2008	-	2007
SEAT	ALTEA	4 CIL, 2.0 L	2008	-	2006
PEUGEOT	207	4 CIL, 1.6 L	2008	-	2009
SEAT	LEON	4 CIL, 2.0 L	2007	-	2006
FORD	RANGER	V-6, 3.0 L	1998	-	1998
MINI	COOPER	4 CIL, 1.6 L	2006	-	2007
VOLKSWAGEN	GOLF	4 CIL, 2.0 L	2006	-	2006

### K060423

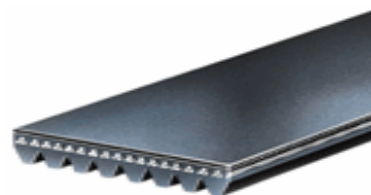

NISSAN	ALTIMA	V-6, 3.5 L	2006	-	2002
NISSAN	MAXIMA	V-6, 3.5 L	2006	-	2005

### K060424

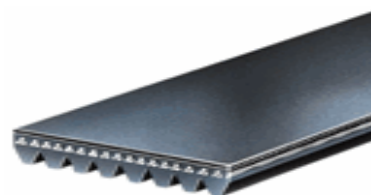

VOLKSWAGEN	POLO	4 CIL, 1.6 L	2007	-	2003
SEAT	IBIZA	4 CIL, 1.6 L	2006	-	2009
ALFA ROMEO	ALFA 147	4 CIL, 2.0 L	2006	-	2004
SEAT	CORDOBA	4 CIL, 1.6 L	2006	-	2008

### K060425

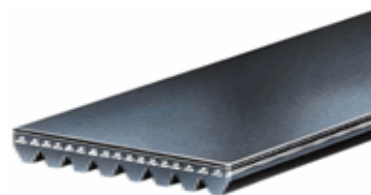

PEUGEOT	306	4 CIL, 1.8 L	2004	-	1999
VOLKSWAGEN	TRANSPORTER	4 CIL, 2.0 L TDI	2010	-	2010

### K060427

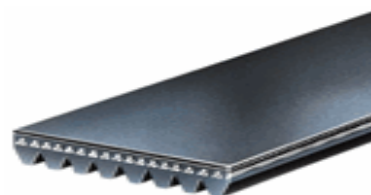

INFINITI	INFINITI I30	V-6, 3.0 L	2001	-	1997
----------	--------------	------------	------	---	------

### K060418

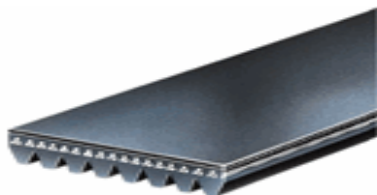

NISSAN	QUEST	6 CIL, 3.5 L	2006	-	2004
NISSAN	MURANO	6 CIL, 3.5 L	2006	-	2004
NISSAN	QUEST	V-6, 3.5 L	2007	-	2009
NISSAN	MAXIMA	V-6, 3.5 L	2008	-	2008

### K060420

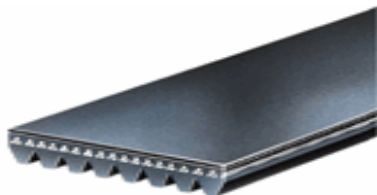

VOLKSWAGEN	SPORTVAN	4 CIL, 1.6 L	2008	-	2006
ALFA ROMEO	ALFA 147	4 CIL, 2.0 L	2006	-	2004
DODGE	INTREPID	V-6, 2.7 L	2003	-	1998
NISSAN	MAXIMA	V-6, 3.5 L	2007	-	2007

### K060431

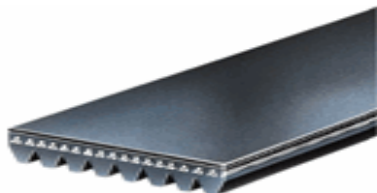

NISSAN	MAXIMA	V-6, 3.5 L	2004	-	2002
INFINITI	INFINITI I30	V-6, 3.0 L	1999	-	1999
NISSAN	MAXIMA	V-6, 3.0 L	1999	-	1999

### K060436

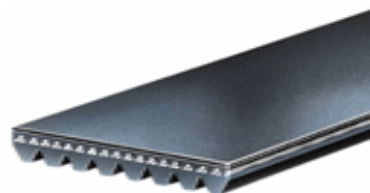

NISSAN	SENTRA	4 CIL, 2.0 L	2001	-	2000
--------	--------	--------------	------	---	------

### K060439

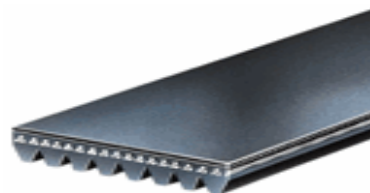

VOLKSWAGEN	PASSAT	4 CIL, 2.0 L TSI	2009	-	2010
AUDI	A3	4 CIL, 2.0 L	2009	-	2009
VOLKSWAGEN	TIGUAN	4 CIL, 2.0 L	2009	-	2010

### K060433

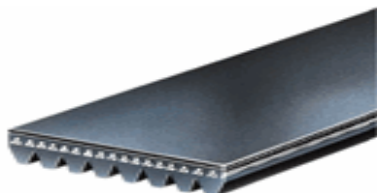

NISSAN	MAXIMA	V-6, 3.0 L	2001	-	1999
HONDA	ACCORD	4 CIL, 2.3 L	2000	-	1999
NISSAN	ALMERA	4 CIL, 1.8 L	2006	-	2003
INFINITI	INFINITI Q45	V-6, 3.0 L	2001	-	2001

### K060441

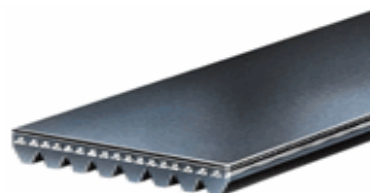

VOLKSWAGEN	BEETLE	4 CIL, 2.0 L	2006	-	2006
VOLKSWAGEN	JETTA	4 CIL, 2.0 L	2006	-	1999
VOLKSWAGEN	BEETLE	4 CIL, 2.0 L	2005	-	2005
VOLKSWAGEN	EUROVAN	4 CIL, 1.9 L DIESE	2006	-	2009
VOLKSWAGEN	GOLF	4 CIL, 1.8 L	2000	-	2000
VOLKSWAGEN	JETTA	4 CIL, 2.0 L	2005	-	2005
VOLKSWAGEN	GOLF	4 CIL, 2.0 L	2005	-	2005
VOLKSWAGEN	GOLF	4 CIL, 2.0 L	2004	-	2002

### K060434

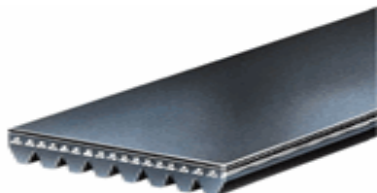

NISSAN	SENTRA	4 CIL, 1.8 L	2004	-	2004
NISSAN	SENTRA	4 CIL, 2.5 L	2004	-	2004

### K060435

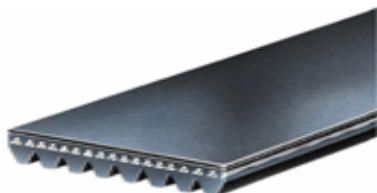

HONDA	ACCORD	4 CIL, 2.3 L	2002	-	1999
NISSAN	MAXIMA	V-6, 3.0 L	2001	-	2000
INFINITI	INFINITI I30	V-6, 3.0 L	2001	-	2000
NISSAN	SENTRA	4 CIL, 1.8 L	2006	-	2000
NISSAN	SENTRA	4 CIL, 1.8 L	2005	-	2005

### K0604413



FORD	IKON	4 CIL, 1.6 L	2002	-	2002
------	------	--------------	------	---	------

## Aplicación por Producto

### K060445

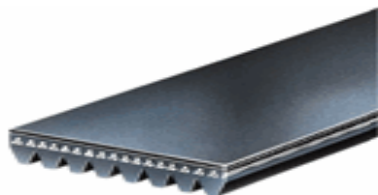

SEAT	LEON	4 CIL, 1.8 L	2005	-	2004
SEAT	TOLEDO	4 CIL, 1.8 L	2005	-	2004

### K060448

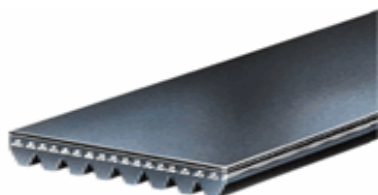

MERCURY	MILAN	V-6, 3.0 L	2010	-	2010
LINCOLN	MKX	V-6, 3.5 L	2007	-	2009
FORD	EDGE	V-6, 3.5 L	2007	-	2010
FORD	ESCAPE	V-6, 3.0 L	2008	-	2010
MERCURY	MARINER	V-6, 3.0 L	2008	-	2009
FORD	FUSION	V-6, 3.5 L	2010	-	2010
FORD	FUSION	V-6, 3.0 L	2010	-	2010
MAZDA	CX-9	V-6, 3.7 L	2007	-	2008
LINCOLN	MKZ	V-6, 3.5 L	2007	-	2009

### K060454

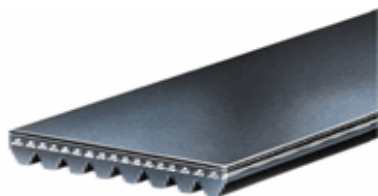

VOLKSWAGEN	BEETLE	4 CIL, 2.0 L	2000	-	2000
------------	--------	--------------	------	---	------

### K060455

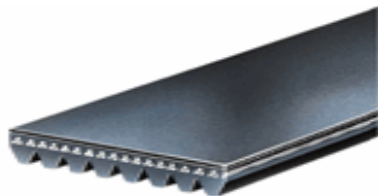

VOLKSWAGEN	GTI	4 CIL, 2.0 L	2000	-	1999
VOLKSWAGEN	DERBY	4 CIL, 1.8 L	2008	-	2003
VOLKSWAGEN	GOLF	4 CIL, 2.0 L	2000	-	2000
VOLKSWAGEN	DERBY	4 CIL, 1.8 L	2005	-	2005

VOLKSWAGEN	VW VAN	4 CIL, 1.6 L	2004	-	2004
VOLKSWAGEN	JETTA	4 CIL, 2.0 L	2000	-	1999
VOLKSWAGEN	VW VAN	4 CIL, 1.8 L	2006	-	2006
VOLKSWAGEN	DERBY	4 CIL, 2.0 L	2004	-	2003
VOLKSWAGEN	VW VAN	4 CIL, 1.8 L	2005	-	2005

### K060458

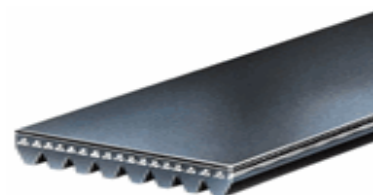

PEUGEOT	306	4 CIL, 2.0 L	2004	-	1999
HONDA	ODYSSEY	V-6, 3.5 L	2004	-	2003
FIAT	DUCATO	4 CIL, 3.0 L DIESE2008	-	-	2010

### K060461

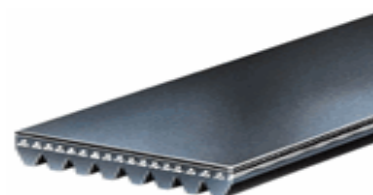

HONDA	ACCORD	V-6, 3.0 L	2002	-	1998
-------	--------	------------	------	---	------

### K060465



CADILLAC	SRX	V-6, 3.6 L	2006	-	2006
NISSAN	350Z	V-6, 3.5 L	2006	-	2003
BMW	750IL	V-12, 5.4 L	2000	-	1998
NISSAN	PATHFINDER LE 4X2	V-6, 3.3 L	2000	-	1997
CADILLAC	SRX	V-6, 3.6 L	2005	-	2004
FORD	ESCORT	4 CIL, 2.0 L	2000	-	1998
NISSAN	PATHFINDER	V-6, 3.5 L	2004	-	2001
HONDA	ODYSSEY	V-6, 3.5 L	2000	-	1999

### K060468

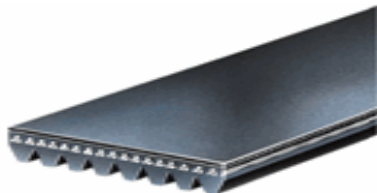

ACURA	TL	V-6, 3.7 L	2009	-	2010
ACURA	TSX	V-6, 3.5 L	2010	-	2010
FORD	ESCORT	4 CIL, 2.0 L	2002	-	1998
HONDA	ODYSSEY	V-6, 3.5 L	2001	-	1999
CADILLAC	SRX	V-6, 3.6 L	2006	-	2006
BMW	750IL	V-12, 5.4 L	2001	-	2001
CADILLAC	SRX	V-6, 3.6 L	2005	-	2004
HONDA	PILOT	V-6, 3.5 L	2004	-	2003
ACURA	TL	V-6, 3.5 L	2009	-	2010
CADILLAC	CTS	V-6, 3.6 L	2007	-	2006
MITSUBISHI	OUTLANDER	V-6, 3.0 L	2007	-	2008
CADILLAC	CTS	V-6, 3.6 L	2005	-	2005

### K060473

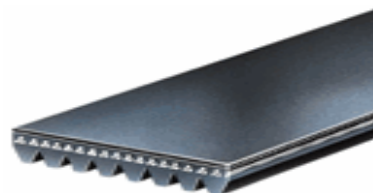

CADILLAC	CTS	V-6, 3.6 L	2007	-	2006
NISSAN	TIIDA	4 CIL, 1.8 L	2008	-	2010
CADILLAC	CTS	V-6, 3.6 L	2005	-	2005
VOLVO	XC90	6 CIL, 3.2 L	2007	-	2010

### K060478

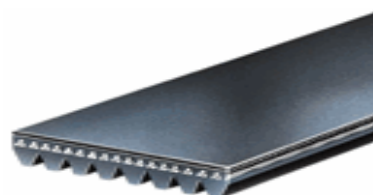

NISSAN	SENTRA	4 CIL, 2.0 L	2008	-	2010
--------	--------	--------------	------	---	------

### K060470

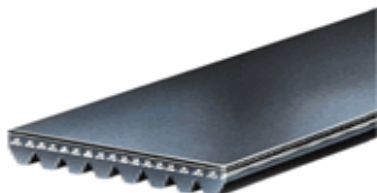

RENAULT	STEPWAY	4 CIL, 1.6 L	2010	-	2010
MITSUBISHI	ENDEAVOR	V-6, 3.8 L	2004	-	2004
RENAULT	SANDERO	4 CIL, 1.6 L	2010	-	2010
MITSUBISHI	ECLIPSE	V-6, 3.0 L	2005	-	2004
DODGE	STRATUS	V-6, 3.0 L	2002	-	2001
MITSUBISHI	ECLIPSE	V-6, 3.8 L	2007	-	2006
MITSUBISHI	ENDEAVOR	V-6, 3.8 L	2007	-	2005
MITSUBISHI	GALANT	V-6, 3.8 L	2004	-	2004
MITSUBISHI	GALANT	V-6, 3.8 L	2007	-	2005
CHRYSLER	SEBRING	V-6, 3.0 L	2006	-	2004
CHRYSLER	SEBRING	V-6, 3.0 L	2005	-	2005

### K060480

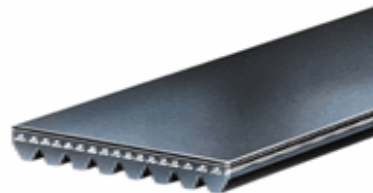

TOYOTA	MATRIX	4 CIL, 1.8 L	2009	-	2010
TOYOTA	COROLLA	4 CIL, 1.8 L	2009	-	2010

### K060472

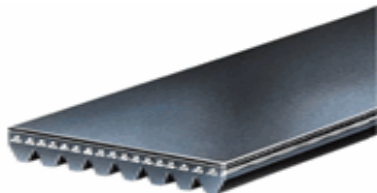

RENAULT	EUROCLIO	4 CIL, 1.6 L	2008	-	2007
RENAULT	MEGANE	4 CIL, 1.6 L	2008	-	2008

### K060486

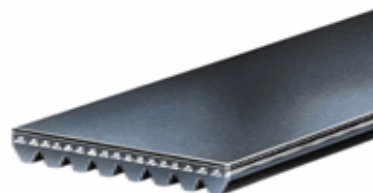

DODGE	STRATUS	4 CIL, 2.4 L	2006	-	2004
-------	---------	--------------	------	---	------

## Aplicación por Producto

### K060490

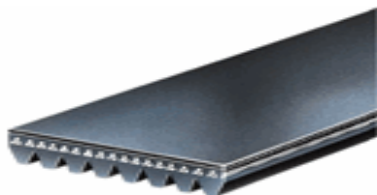

CHRYSLER	CIRRUS	4 CIL, 2.4 L	2005	-	2005
DODGE	STRATUS	4 CIL, 2.0 L	2006	-	2005
CHRYSLER	SEBRING	4 CIL, 2.4 L	2006	-	2005

### K060494

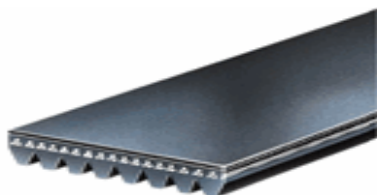

TOYOTA	RAV 4	4 CIL, 2.5 L	2009	-	2010
--------	-------	--------------	------	---	------

### K060500

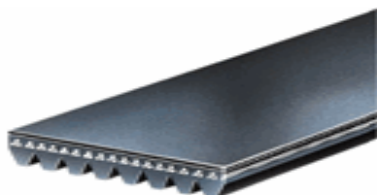

FORD	FOCUS	4 CIL, 2.0 L	2004	-	2003
------	-------	--------------	------	---	------

### K060505

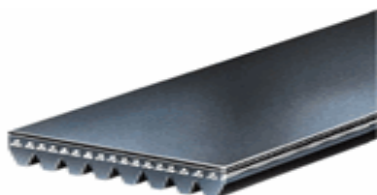

FORD	ESCORT	4 CIL, 2.0 L	1999	-	1999
------	--------	--------------	------	---	------

### K060507

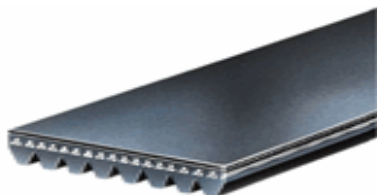

FORD	ESCORT	4 CIL, 2.0 L	2002	-	1998
FORD	ESCORT	4 CIL, 1.9 L	1997	-	1997

### K060514

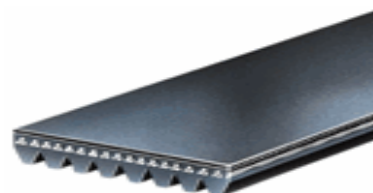

MAZDA	MAZDA 3	4 CIL, 2.0 L	2008	-	2009
-------	---------	--------------	------	---	------

### K060520

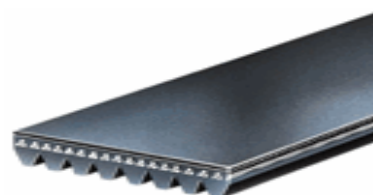

MAZDA	MAZDA 5	4 CIL, 2.3 L	2007	-	2006
MAZDA	MAZDA 3	4 CIL, 2.3 L	2008	-	2006

### K060523

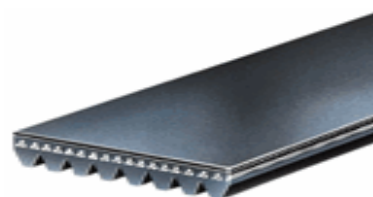

MERCEDES BE	SLK230	4 CIL, 2.3 L	1999	-	1998
MERCEDES BE	C230	4 CIL, 2.3 L	2000	-	1999

### K060525

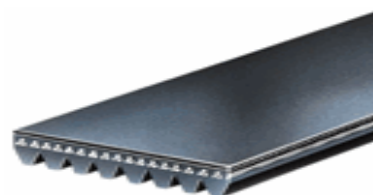

DODGE	STRATUS	4 CIL, 2.4 L	2002	-	2001
NISSAN	ALTIMA	4 CIL, 2.4 L	2001	-	1999



### K060529

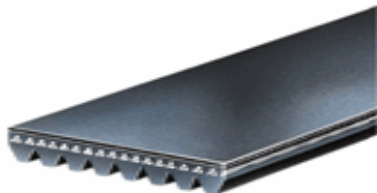

DODGE	INTREPID	V-6, 3.2 L	2001 - 1999
CHRYSLER	CONCORDE	V-6, 3.2 L	2001 - 1998
CHRYSLER	300M	V-6, 3.5 L	2003 - 1999
DODGE	STRATUS	4 CIL, 2.4 L	1997 - 1997
CHRYSLER	CONCORDE	V-6, 3.5 L	2002 - 2002
DODGE	INTREPID	V-6, 3.5 L	2002 - 2000

### K060551

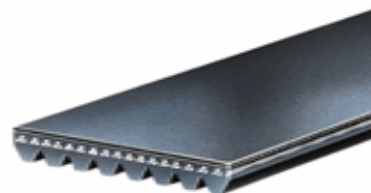

DODGE	STRATUS	V-6, 2.7 L	2002 - 2001
CHRYSLER	SEBRING	4 CIL, 2.4 L	1996 - 1996

### K060557



CHRYSLER	SEBRING	V-6, 2.5 L	1997 - 1996
----------	---------	------------	-------------

### K060560



CHRYSLER	CIRRUS	V-6, 2.5 L	2000 - 1999
CHRYSLER	SEBRING	V-6, 2.5 L	2000 - 1996
DODGE	STRATUS	V-6, 2.5 L	2000 - 1999

### K060570

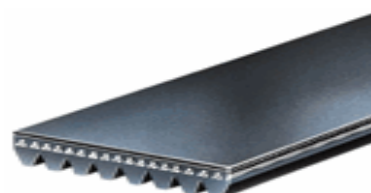

PEUGEOT	206	4 CIL, 1.4 L	1998 - 2001
CHEVROLET	CHEVY C2 SEDAN	4 CIL, 1.6 L	2007 - 2004
CHEVROLET	CHEVY	4 CIL, 1.6 L	2009 - 2010
CHEVROLET	CHEVY C2	4 CIL, 1.6 L	2008 - 2004
PEUGEOT	206	4 CIL, 1.6 L	1998 - 2001
CHEVROLET	CHEVY PICK-UP	4 CIL, 1.6 L	2006 - 2002

### K060530

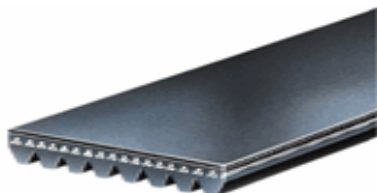

VOLKSWAGEN	EUROVAN	5 CIL, 2.5 L	2004 - 2004
------------	---------	--------------	-------------

### K060532

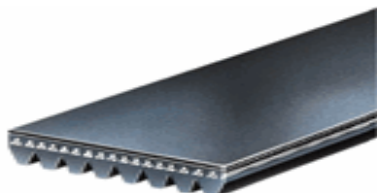

MERCEDES BE	SLK230	4 CIL, 2.3 L	2004 - 2000
FORD	FOCUS	4 CIL, 2.0 L	2002 - 2000
VOLKSWAGEN	EUROVAN	5 CIL, 2.5 L	2002 - 2003
VOLKSWAGEN	EUROVAN	5 CIL, 2.5 L	2005 - 2005
DODGE	STRATUS	4 CIL, 2.0 L	2000 - 1998
CHRYSLER	CIRRUS	4 CIL, 2.0 L	2000 - 2000

### K060547

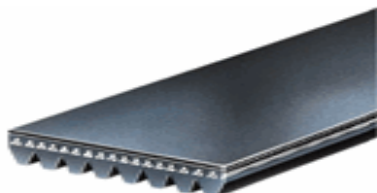

MINI	COOPER	4 CIL, 1.6 L	2006 - 2008
CHRYSLER	SEBRING	4 CIL, 2.4 L	1999 - 1997

### K060572

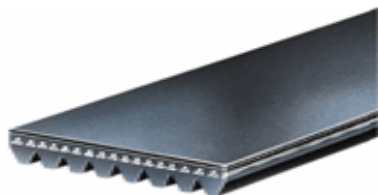

CHEVROLET	CRUZE	4 CIL, 1.8 L	2010	-	2011
-----------	-------	--------------	------	---	------

### K060573

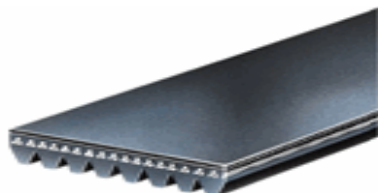

BMW	Z4	6 CIL, 2.5 L	2003	-	2003
BMW	Z4	V-6, 3.0 L	2004	-	2004
BMW	Z4	V-6, 2.5 L	2006	-	2004
BMW	Z4	6 CIL, 3.0 L	2003	-	2003

### K060578

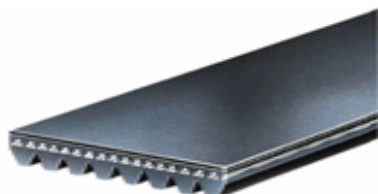

BMW	M3	V-6, 3.2 L	2004	-	2004
BMW	M3	V-6, 3.2 L	2006	-	2005

### K060588

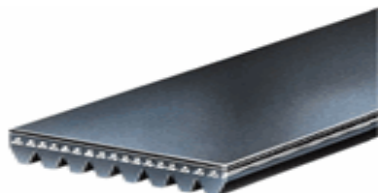

MITSUBISHI	L200	4 CIL, 2.5 L	2008	-	2009
------------	------	--------------	------	---	------

### K060590

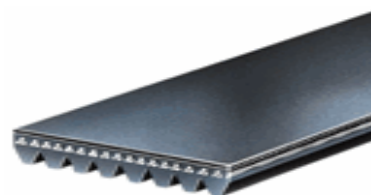

VOLKSWAGEN	POINTER STATION WAGON	4 CIL, 1.8 L	2000	-	1999
VOLKSWAGEN	POINTER PICK-UP	4 CIL, 1.8 L	2001	-	1999
VOLKSWAGEN	POINTER	4 CIL, 1.8 L	2001	-	1999

### K060605

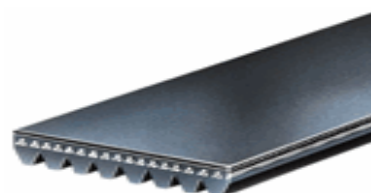

BMW	Z3	V-6, 3.0 L	2001	-	2001
TOYOTA	COROLLA	4 CIL, 1.8 L	2005	-	2005
BMW	320I	V-6, 2.2 L	2005	-	2004
BMW	328I	V-6, 2.8 L	2000	-	1999
BMW	330CI	6 CIL, 3.0 L	2003	-	2001
BMW	323I	V-6, 2.5 L	2000	-	1999
BMW	528I	V-6, 2.8 L	2000	-	1999
BMW	325CI	V-6, 2.5 L	2002	-	2002
BMW	525I	6 CIL, 2.5 L	2005	-	2001
BMW	330XI	6 CIL, 3.0 L	2001	-	2001
BMW	325CI	V-6, 2.5 L	2005	-	2001
CHEVROLET	TIGRA	4 CIL, 1.6 L	1999	-	2000
BMW	X5	V-6, 3.0 L	2004	-	2004
BMW	X5	6 CIL, 3.0 L	2005	-	2005
BMW	325I	V-6, 2.5 L	2005	-	2001
BMW	330CI	V-6, 3.0 L	2006	-	2005
BMW	330XI	6 CIL, 3.0 L	2006	-	2005
BMW	323CI	V-6, 2.5 L	2000	-	2000
BMW	X3	6 CIL, 3.0 L	2005	-	2005
BMW	X5	6 CIL, 3.0 L	2006	-	2006
BMW	Z3	V-6, 2.5 L	2001	-	2000
TOYOTA	MATRIX	4 CIL, 1.8 L	2008	-	2003
BMW	330CI	V-6, 3.0 L	2004	-	2004
BMW	X3	6 CIL, 3.0 L	2006	-	2006
BMW	325XI	6 CIL, 2.5 L	2005	-	2005
TOYOTA	COROLLA	4 CIL, 1.8 L	2008	-	2002

### K060609

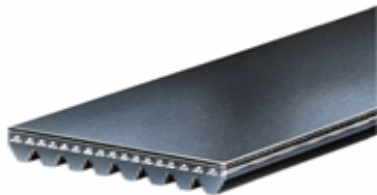

BMW	545I	V-8, 4.4 L	2004	-	2004
BMW	745LI	V-8, 4.4 L	2005	-	2005
BMW	760LI	V-12, 6.0 L	2005	-	2005
BMW	745I	V-8, 4.4 L	2005	-	2003
BMW	545I	V-8, 4.4 L	2005	-	2005
BMW	650I	V-8, 4.4 L	2006	-	2006
BMW	760LI	V-12, 6.0 L	2004	-	2004
BMW	645CI	V-8, 4.4 L	2005	-	2005
BMW	760I	V-12, 6.0 L	2005	-	2005
BMW	550I	V-8, 4.4 L	2006	-	2006

### K060620

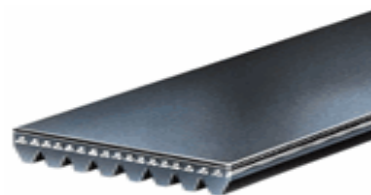

DODGE	INTREPID	V-6, 2.7 L	1999	-	1998
AUDI	A4	4 CIL, 2.0 L	2007	-	2007
AUDI	A4	4 CIL, 1.8 L	2006	-	2005
CHRYSLER	CONCORDE	V-6, 2.7 L	1999	-	1998

### K060623

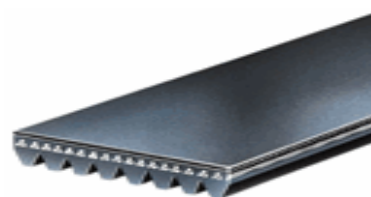

RENAULT	LAGUNA	V6, 2.4 L	2006	-	2005
RENAULT	LAGUNA	V-6, 2.4 L	2004	-	2004

### K060625

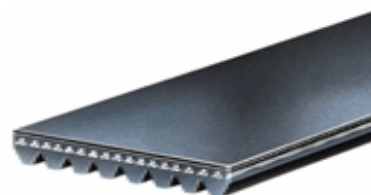

AUDI	A4	4 CIL, 1.8 L	2003	-	2003
AUDI	A4	4 CIL, 1.8 L	2004	-	2004

### K060630

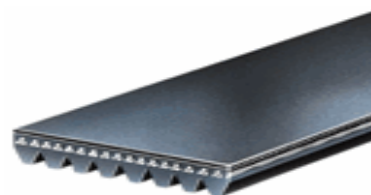

DODGE	INTREPID	V-6, 2.7 L	2003	-	2000
PEUGEOT	306	4 CIL, 2.0 L	2004	-	1999
PEUGEOT	406	V-6, 3.0 L	2003	-	2002
PEUGEOT	407	V-6, 3.0 L	2008	-	2005
PEUGEOT	406	4 CIL, 2.0 L	2002	-	2003
CHRYSLER	CONCORDE	V-6, 2.7 L	2000	-	2000

### K060612

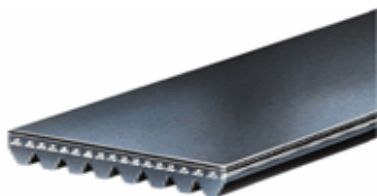

BMW	528I	V-6, 2.8 L	1998	-	1998
CHEVROLET	CRUZE	4 CIL, 1.8 L	2010	-	2011
BMW	328IS	V-6, 2.8 L	1999	-	1998
BMW	Z3	V-6, 2.8 L	2000	-	1998
BMW	M3	V-6, 3.2 L	1999	-	1999
BMW	Z3	V-6, 2.5 L	2000	-	1999
LAND ROVER	FREELANDER	V-6, 2.5 L	2005	-	2002
BMW	M	V-6, 3.2 L	2000	-	1999
VOLKSWAGEN	TRANSPORTER	4 CIL, 2.0 L TDI	2010	-	2010
BMW	328I	V-6, 2.8 L	1998	-	1998
BMW	323IS	V-6, 2.5 L	1999	-	1998

### K060615

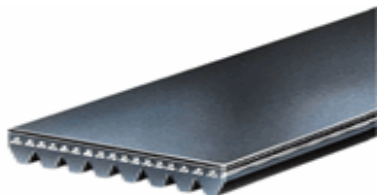

PEUGEOT	PARTNER	4 CIL, 1.6 L	2008	-	2004
PEUGEOT	206	4 CIL, 1.4 L	2008	-	1998
PEUGEOT	GRAND RAID	4 CIL, 1.6 L	2008	-	2004
PEUGEOT	206	4 CIL, 1.6 L	2008	-	1998

### K060635

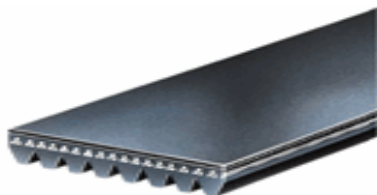

AUDI	A3	V-6, 3.2 L	2007 - 2008
AUDI	TT	V-6, 3.2 L	2007 - 2007

### K060660

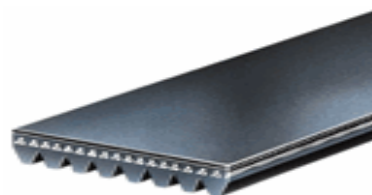

CHEVROLET	ZAFIRA	4 CIL, 2.4 L	2006 - 2004
FORD	TRANSIT	4 CIL, 2.2 L	2009 - 2010
FORD	TRANSIT	4 CIL, 2.2 L TDI	2008 - 2008
CHEVROLET	ASTRA	4 CIL, 2.4 L	2006 - 2004
CHEVROLET	ASTRA	4 CIL, 2.2 L	2003 - 2000
CHEVROLET	ZAFIRA	4 CIL, 2.2 L	2003 - 2000
CHEVROLET	ZAFIRA	4 CIL, 2.0 L	2006 - 2004
CHEVROLET	ASTRA	4 CIL, 2.0 L	2006 - 2004

### K060637

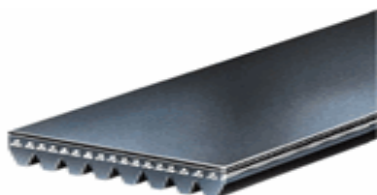

FAW	F1	3 CIL, 1.0 L	2008 - 2009
VOLKSWAGEN	PASSAT	V-6, 3.6 L	2008 - 2006
SUBARU	B9 TRIBECA	6 CIL, 3.0 L	2007 - 2006
CHEVROLET	S-10	4 CIL, 2.2 L	2003 - 1998

### K060663

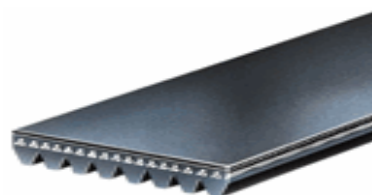

CHEVROLET	MONTE CARLO	V-6, 3.8 L	2005 - 2004
CHEVROLET	ASTRA	4 CIL, 2.0 L	2008 - 2007
CHEVROLET	IMPALA	V-6, 3.8 L	2004 - 2004
PONTIAC	GRAND PRIX	V-6, 3.8 L	2002 - 1997
CHEVROLET	IMPALA	V-6, 3.8 L	2005 - 2005

### K060642

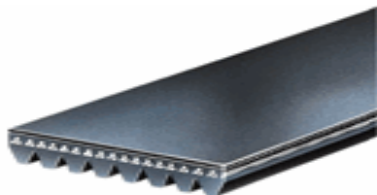

PONTIAC	FIREBIRD TRANS AM	V-8, 5.7 L	1997 - 1997
---------	-------------------	------------	-------------

### K060667

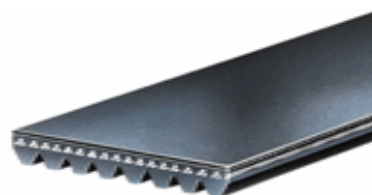

FORD	FOCUS	4 CIL, 2.0 L	2004 - 2003
------	-------	--------------	-------------

### K060653

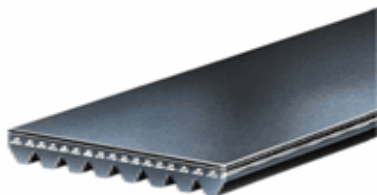

VOLKSWAGEN	JETTA	4 CIL, 1.9 L DIESE2004	- 2000
PEUGEOT	306	4 CIL, 1.8 L	2004 - 1999
RENAULT	CLIO	4 CIL, 2.0 L SPOR2006	- 2003

### K060669

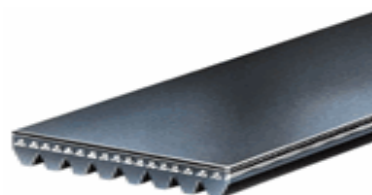

VOLKSWAGEN	CROSSFOX	4 CIL, 1.6 L	2008 - 2005
VOLKSWAGEN	LUPO	4 CIL, 1.6 L	2008 - 2004

## Aplicación por Producto

VOLKSWAGEN SPORTVAN 4 CIL, 1.6 L 2008 - 2006

AUDI S4 QUATTRO V-6, 2.7 L 2000 - 2000

### K060670

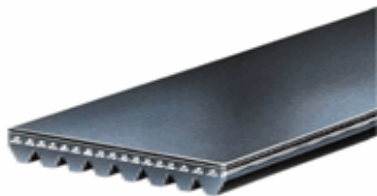

FORD	IKON	4 CIL, 1.6 L	2005	-	2005
FORD	IKON	4 CIL, 1.6 L	2004	-	2007
PONTIAC	GRAND PRIX	V-6, 3.8 L	2005	-	2003
FORD	KA	4 CIL, 1.6 L	2005	-	2005
FORD	COURIER	4 CIL, 1.6 L	2006	-	2007
FORD	KA	4 CIL, 1.6 L	2004	-	2007
FORD	FIESTA	4 CIL, 1.6 L	2008	-	2010

### K060672

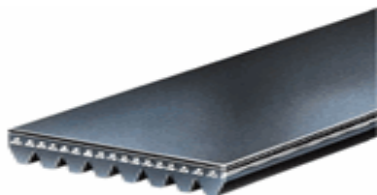

PEUGEOT 307 4 CIL, 2.0 L 2008 - 2009

### K060680

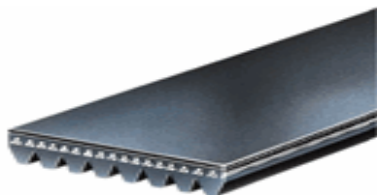

FORD FOCUS 4 CIL, 2.0 L 2002 - 2001

### K060682

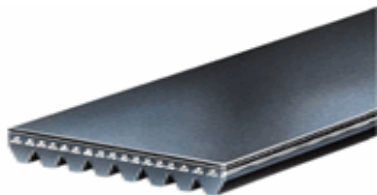

BMW	318TI	4 CIL, 1.9 L	1999	-	1998
BMW	318i	4 CIL, 1.9 L	1998	-	1998
BMW	Z3	4 CIL, 1.9 L	1998	-	1998
AUDI	S4 QUATTRO	V-6, 2.7 L	2002	-	2001
MERCURY	MYSTIQUE	4 CIL, 2.0 L	1997	-	1996

### K060683



VOLKSWAGEN POINTER 4 CIL, 1.8 L 2008 - 2002

### K060685

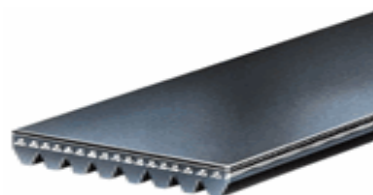

FORD	F SERIES PICKUP	V-8, 7.5 L	1997	-	1997
PONTIAC	GRAND AM	V-6, 3.1 L	1998	-	1997
CHEVROLET	CUTLASS	V-6, 3.1 L	1998	-	1997
VOLKSWAGEN	POINTER PICK-UP	4 CIL, 1.8 L	2005	-	2002
FORD	F-450 SUPER DUTY	V-8, 7.5 L	1998	-	1997

### K060690

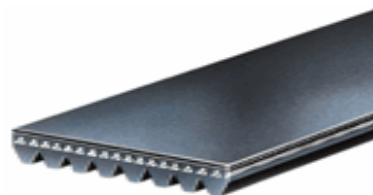

CHEVROLET	COLORADO	5 CIL, 3.5 L	2004	-	2004
CHEVROLET	COLORADO	4 CIL, 2.8 L	2005	-	2005
CHEVROLET	COLORADO	5 CIL, 3.5 L	2006	-	2005
MERCEDES BE	SLK230	4 CIL, 2.3 L	2001	-	2000
CHEVROLET	COLORADO	4 CIL, 2.8 L	2006	-	2006

### K060695



CHRYSLER	PACIFICA	V-6, 4.0 L	2008	-	2007
CHRYSLER	TOWN & COUNTRY	V6, 4.0 L	2008	-	2010
CHEVROLET	VENTURE	V-6, 3.4 L	1998	-	1997



## Aplicación por Producto

CHEVROLET	LUMINA	V-6, 3.1 L	1998 - 1998
CHEVROLET	CENTURY	V-6, 3.1 L	1998 - 1997
PONTIAC	GRAND PRIX	V-6, 3.1 L	1998 - 1997
DODGE	JOURNEY	V-6, 3.5 L	2009 - 2010

CHEVROLET	CHEVY PICK-UP	4 CIL, 1.6 L	2003 - 2002
-----------	---------------	--------------	-------------

### K060708

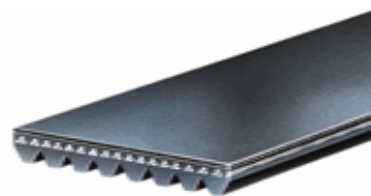

CHEVROLET	CHEVY C2 SEDAN	4 CIL, 1.6 L	2008 - 2004
CHEVROLET	CHEVY C2	4 CIL, 1.6 L	2008 - 2004
RENAULT	TRAFIC	4 CIL, 1.9 L DIESE	2008 - 2010
CHEVROLET	MONZA	4 CIL, 1.6 L	2004 - 2001
CHEVROLET	CHEVY	4 CIL, 1.6 L	2009 - 2010
CHEVROLET	CHEVY PICK-UP	4 CIL, 1.6 L	2006 - 2004

### K060710

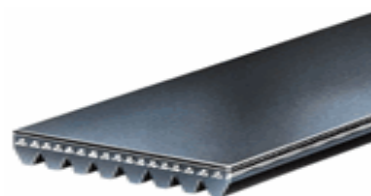

JEEP	CHEROKEE	6 CIL, 4.0 L	1996 - 1996
FORD	FOCUS	4 CIL, 2.0 L	2001 - 2000

### K060711

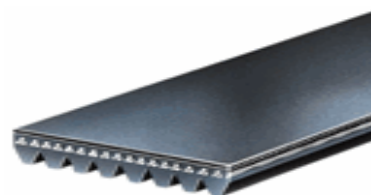

RENAULT	KOLEOS	4 CIL, 2.5 L	2009 - 2010
NISSAN	ROGUE	4 CIL, 2.5 L	2008 - 2010
NISSAN	SENTRA	4 CIL, 2.5 L	2008 - 2010
NISSAN	X-TRAIL	4 CIL, 2.5 L	2008 - 2008

### K060721

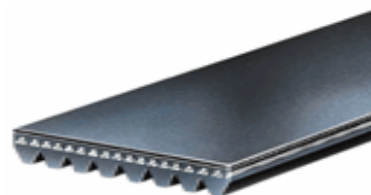

RENAULT	SANDERO	4 CIL, 1.6 L	2010 - 2010
RENAULT	STEPWAY	4 CIL, 1.6 L	2010 - 2010

### K060696

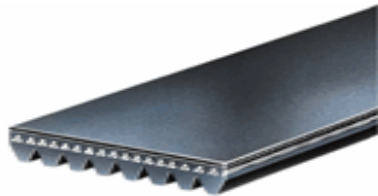

CHEVROLET	CENTURY	V-6, 3.1 L	1996 - 1996
FORD	RANGER F-100	4 CIL, 2.3 L	2000 - 1996
FORD	RANGER	4 CIL, 2.5 L	2001 - 1999
FORD	RANGER	4 CIL, 2.3 L	1997 - 1996
FORD	RANGER	V-6, 3.0 L	1998 - 1998
TOYOTA	YARIS	4 CIL, 1.3 L	2004 - 2003

### K060703

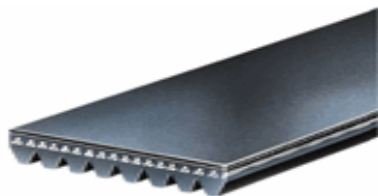

CHEVROLET	MONTE CARLO	V-6, 3.4 L	2005 - 2004
CHEVROLET	MONTE CARLO	V-6, 3.8 L	2004 - 2004
PONTIAC	GRAND PRIX	V-6, 3.1 L	2002 - 1999
CHEVROLET	LUMINA	V-6, 3.4 L	1996 - 1996
CHEVROLET	VENTURE	V-6, 3.4 L	1998 - 1997
CHEVROLET	IMPALA	V-6, 3.4 L	2004 - 2000
CHEVROLET	IMPALA	V-6, 3.4 L	2005 - 2003
OLDSMOBILE	SILHOUETTE	V-6, 3.4 L	1996 - 1996
CHEVROLET	CENTURY	V-6, 3.1 L	1999 - 1999

### K060705

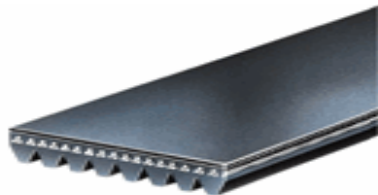

NISSAN	LANCER	4 CIL, 2.0 L	2006 - 2005
SUZUKI	KIZASHI	4 CIL, 2.4 L	2010 - 2010
CHEVROLET	TIGRA	4 CIL, 1.6 L	1999 - 1999
CHEVROLET	TIGRA	4 CIL, 1.6 L	2000 - 2000
NISSAN	LANCER	4 CIL, 2.0 L	2004 - 2004

## Aplicación por Producto

MERCURY	MYSTIQUE	V-6, 2.5 L	2000	-	1998
FORD	CONTOUR	V-6, 2.5 L	2000	-	1998
PONTIAC	BONNEVILLE	V-6, 3.8 L	1999	-	1996
OLDSMOBILE	EIGHTY EIGHT	V-6, 3.8 L	1999	-	1999
TOYOTA	RUSH	4 CIL, 1.5 L	2009	-	2010

### K060735

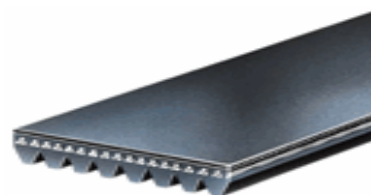

MERCEDES BE	SLK230	4 CIL, 2.3 L	2004	-	2000
CHEVROLET	VECTRA	V-6, 3.2 L	2006	-	2003

### K060739



PONTIAC	BONNEVILLE	V-6, 3.8 L	2003	-	2000
---------	------------	------------	------	---	------

### K060730

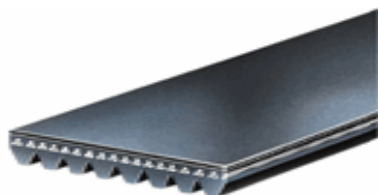

AUDI	ALLROAD QUATTRO	V-6, 2.7 L	2006	-	2002
AUDI	S4 QUATTRO	V-6, 2.7 L	2000	-	2000
AUDI	A6	V-6, 3.0 L	2003	-	2002
AUDI	A4	V-6, 3.0 L	2004	-	2002
AUDI	S4 QUATTRO	V-6, 2.7 L	2002	-	2001
FORD	RANGER	4 CIL, 2.3 L	2007	-	2010
AUDI	A4	V-6, 3.0 L	2006	-	2003
AUDI	A6	V-6, 3.0 L	2004	-	2004
AUDI	ALLROAD QUATTRO	V-6, 2.7 L	2005	-	2005

### K060733

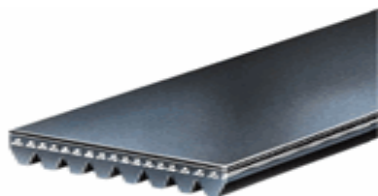

MERCURY	MYSTIQUE	4 CIL, 2.0 L	1997	-	1996
NISSAN	XTERRA	V-6, 3.3 L	2002	-	2002
NISSAN	FRONTIER	V-6, 3.3 L	2004	-	2001

SUZUKI	SWIFT	4 CIL, 1.6 L	2007	-	2008
AUDI	A6	V-6, 3.0 L	2003	-	2002
TOYOTA	MATRIX	4 CIL, 1.8 L	2008	-	2003
TOYOTA	RUSH	4 CIL, 1.5 L	2009	-	2010
MERCEDES BE	C230	4 CIL, 2.3 L	2000	-	1999
AUDI	A6	V-6, 3.0 L	2004	-	2004
PONTIAC	G3	4 CIL, 1.6 L	2008	-	2006
AUDI	A4	V-6, 3.0 L	2004	-	2002
NISSAN	LANCER	4 CIL, 2.4 L	2006	-	2004
VOLKSWAGEN	GOLF	V-6, 2.8 L	2000	-	1998
NISSAN	GRANDIS	4 CIL, 2.4 L	2008	-	2007
VOLKSWAGEN	PASSAT	V-6, 2.8 L	2004	-	1998
VOLKSWAGEN	JETTA	V-6, 2.8 L	2002	-	1998
AUDI	A4	V-6, 2.8 L	2000	-	1998
CHEVROLET	AVEO	4 CIL, 1.6 L	2008	-	2009
AUDI	A6	V-6, 2.8 L	2001	-	1998
MERCEDES BE	SLK230	4 CIL, 2.3 L	1999	-	1998
TOYOTA	COROLLA	4 CIL, 1.8 L	2008	-	2003
TOYOTA	COROLLA	4 CIL, 1.8 L	2005	-	2005
TOYOTA	MATRIX	4 CIL, 1.8 L	2005	-	2005
AUDI	A4	V-6, 3.0 L	2006	-	2003
VOLKSWAGEN	PASSAT	V-6, 2.8 L	2005	-	2005

### K060740

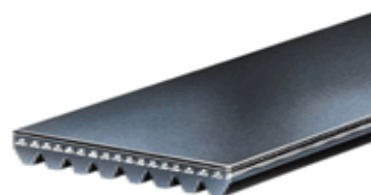

TOYOTA	AVANZA	4 CIL, 1.5 L	2008	-	2007
--------	--------	--------------	------	---	------

## Aplicación por Producto

TOYOTA	AVANZA	4 CIL. 1.5 L	2009	-	2010
--------	--------	--------------	------	---	------

PORSCHE	BOXSTER	6 CIL, 2.7 L	2002	-	2006
PORSCHE	BOXSTER	6 CIL, 3.2 L	2002	-	2000

### K060744

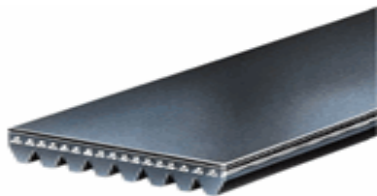

MITSUBISHI	OUTLANDER	4 CIL, 2.4 L	2006	-	2004
CHEVROLET	S-10	4 CIL, 2.2 L	2002	-	1998
MITSUBISHI	GALANT	4 CIL, 2.4 L	2004	-	2004
CHEVROLET	S-10	4 CIL, 2.2 L	2003	-	2003
CHEVROLET	OPTRA	4 CIL, 2.0 L	2008	-	2006
CHEVROLET	OPTRA	4 CIL, 2.0 L	2009	-	2010
TOYOTA	COROLLA	4 CIL, 1.8 L	2002	-	2002
MITSUBISHI	GALANT	4 CIL, 2.4 L	2007	-	2005

### K060763

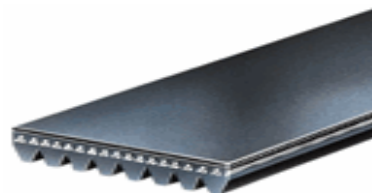

FORD	FOCUS	4 CIL, 2.0 L	2001	-	2001
FORD	FIESTA	4 CIL, 1.4 L	2003	-	1999
TOYOTA	MATRIX	4 CIL, 1.8 L	2006	-	2003
TOYOTA	COROLLA	4 CIL, 1.8 L	2006	-	2005
CHRYSLER	PACIFICA	V-6, 3.8 L	2005	-	2005
CHRYSLER	PACIFICA	V-6, 3.8 L	2006	-	2006
PONTIAC	G8	V8, 6.0 L	2009	-	2009

### K060750

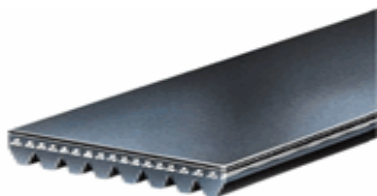

JEEP	WRANGLER	6 CIL, 4.0 L	2005	-	2005
JEEP	WRANGLER	6 CIL, 4.0 L	2006	-	2003
JEEP	WRANGLER	V-6, 4.0 L	2004	-	2004
MERCURY	SABLE / TAURUS	V-6, 3.0 L	1999	-	1996

### K060772

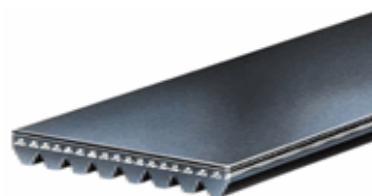

INFINITI	INFINITI Q45	V-8, 4.5 L	2002	-	2002
----------	--------------	------------	------	---	------

### K060755

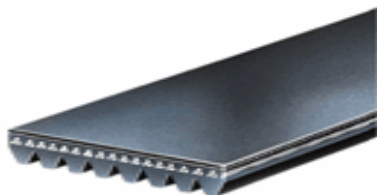

MERCURY	SABLE / TAURUS	V-6, 3.0 L	2000	-	2000
---------	----------------	------------	------	---	------

### K060775

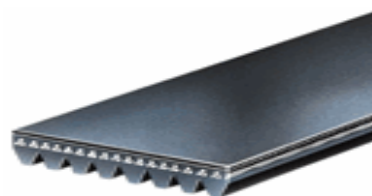

ALFA ROMEO	ALFA 147	4 CIL, 2.0 L	2006	-	2004
JEEP	WRANGLER	4 CIL, 2.5 L	1999	-	1997
JEEP	CHEROKEE	4 CIL, 2.5 L	1998	-	1997
FORD	FOCUS	4 CIL, 2.0 L	2004	-	2000
FORD	ESCAPE	4 CIL, 2.0 L	2002	-	2001

### K060760

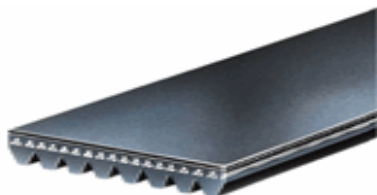

PORSCHE	BOXSTER	6 CIL, 2.5 L	1999	-	1999
---------	---------	--------------	------	---	------

### K060780

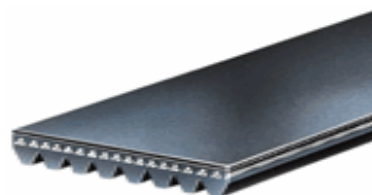

## Aplicación por Producto

ALFA ROMEO ALFA 147 4 CIL, 2.0 L 2006 - 2004

### K060798

### K060785

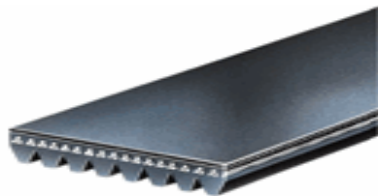

BMW	325CI	V-6, 2.5 L	2006	-	2006
BMW	X5	V-6, 3.0 L	2009	-	2009
BMW	325I	V-6, 3.0 L	2006	-	2006
BMW	X3	V-6, 3.0 L	2007	-	2008
CHEVROLET	VECTRA	V-6, 3.2 L	2006	-	2003
BMW	325XI	V-6, 3.0 L	2006	-	2006

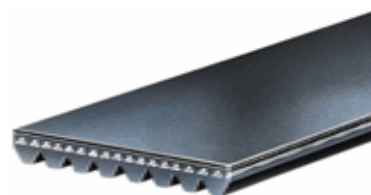

CHEVROLET	CORVETTE	V-8, 6.0 L	2005	-	2005
CHEVROLET	CORVETTE	V-8, 6.0 L	2007	-	2006
FORD	F-250	V-8, 4.6 L	2004	-	2002
CHEVROLET	CORVETTE	V-8, 5.7 L	2001	-	1999

### K060802

### K060790

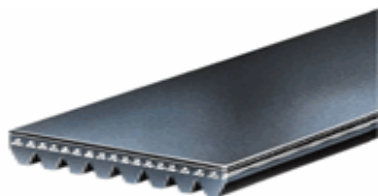

JEEP	CHEROKEE	4 CIL, 2.5 L	1998	-	1996
CHEVROLET	CAMARO Z28	V-8, 5.7 L	2002	-	1998
JEEP	CHEROKEE	6 CIL, 4.0 L	1999	-	1997
VOLKSWAGEN	CRAFTER	5 CIL, 2.5 L TDI	2008	-	2010
PONTIAC	FIREBIRD TRANS AM	V-8, 5.7 L	2002	-	1998
JEEP	WRANGLER	6 CIL, 4.0 L	2002	-	1999
JEEP	WRANGLER	4 CIL, 2.5 L	2002	-	1997
PONTIAC	TRANS AM FIREBIRD	V-8, 5.7 L	2001	-	1998



DODGE	CALIBER	4 CIL, 2.4 L	2008	-	2009
JEEP	PATRIOT	4 CIL, 2.4 L	2008	-	2010
MERCURY	MYSTIQUE	4 CIL, 2.0 L	2000	-	1999
FORD	LOBO	V-8, 4.6 L	2003	-	2003
JEEP	COMPASS	4 CIL, 2.4 L	2008	-	2010
FORD	LOBO	V-8, 5.4 L	2003	-	2003
FORD	CONTOUR	4 CIL, 2.0 L	2000	-	1998

### K060806

### K060795

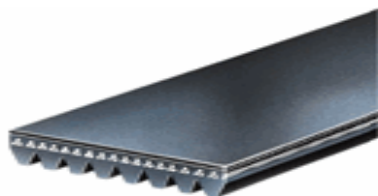

SAAB	9 - 3	V-6, 3.0 L	2001	-	1999
CADILLAC	CATERA	V-6, 3.0 L	2001	-	1998
DODGE	DURANGO	V-8, 5.7 L	2008	-	2009
SAAB	9 - 5	V-6, 3.0 L	2002	-	2002
VOLKSWAGEN	ROUTAN	V-6, 3.8 L	2009	-	2010
DODGE	RAM 2500	V-8, 5.7 L	2009	-	2009
CHEVROLET	CORVETTE	V-8, 5.7 L	2001	-	1999

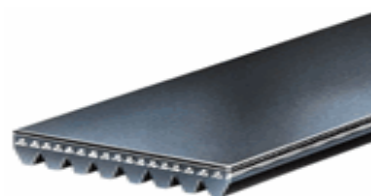

FORD	SUPER DUTY VAN	V-8, 5.4 L	2002	-	2002
FORD	E SERIES VAN	V-8, 5.4 L	2007	-	2010
FORD	E SERIES VAN	V-8, 4.6 L	2006	-	2010
SUZUKI	GRAND VITARA	4 CIL, 2.4 L	2009	-	2010
FORD	F-450 SUPER DUTY	V-10, 6.8 L	2007	-	2010
FORD	F-550 SUPER DUTY	V-10, 6.8 L	2008	-	2010
CHRYSLER	VOYAGER	V-6, 3.0 L	1998	-	1996
FORD	SUPER DUTY PICKUP	V-8, 5.4 L	2003	-	2002
FORD	SUPER DUTY VAN	V-8, 4.6 L	2003	-	2003
FORD	SUPER DUTY VAN	V-10, 6.8 L	2002	-	2002
MERCURY	MYSTIQUE	4 CIL, 2.0 L	1998	-	1998
FORD	SUPER DUTY PICKUP	V-10, 6.8 L	2002	-	2002
SUZUKI	SX4	4 CIL, 2.0 L	2010	-	2010
FORD	F-350 SUPER DUTY	V-8, 5.4 L	2004	-	2010

### K060810

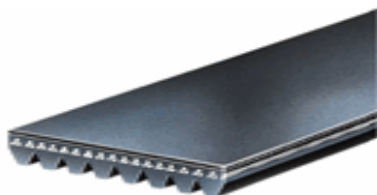

FORD	RANGER	V-6, 4.0 L	2001	-	1999
------	--------	------------	------	---	------

### K060815

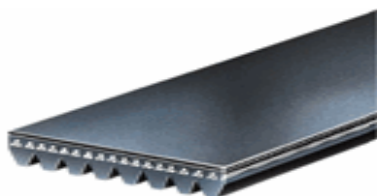

DODGE	CHARGER	V-8, 6.1 L	2008	-	2007
MERCURY	SABLE / TAURUS	V-6, 3.0 L	2005	-	2001
JEEP	GRAND CHEROKEE	V-8, 6.1 L	2007	-	2009
FORD	MONDEO	V-6, 2.5 L	2003	-	2003
CADILLAC	DEVILLE	V-8, 4.6 L	2005	-	2000
CADILLAC	SEVILLE	V-8, 4.6 L	2004	-	1998
NISSAN	FRONTIER	4 CIL, 2.5 L	2007	-	2005

### K060820

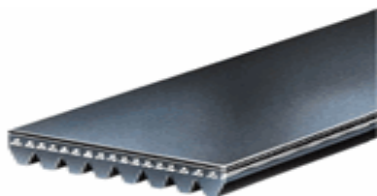

FORD	RANGER	V-6, 3.0 L	1998	-	1998
FORD	RANGER	4 CIL, 2.5 L	2001	-	1999
FORD	RANGER F-100	4 CIL, 2.3 L	2000	-	1996
FORD	ESCAPE	V-6, 3.0 L	2004	-	2001
JEEP	GRAND CHEROKEE	V-8, 5.7 L	2007	-	2009
FORD	RANGER	4 CIL, 2.3 L	1997	-	1996
FORD	MONDEO	V-6, 2.5 L	2006	-	2003
JEEP	COMMANDER	V-8, 5.7 L	2008	-	2006

### K060825

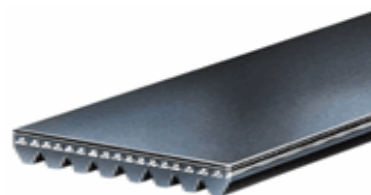

DODGE	CHARGER	V-8, 6.1 L	2009	-	2009
CHRYSLER	VOYAGER	V-6, 3.8 L	2006	-	2004
DODGE	CARAVAN	V-6, 3.3 L FLEX	2003	-	2001
DODGE	CHARGER	V-6, 3.5 L	2008	-	2009
CHRYSLER	VOYAGER	V-6, 3.3 L	2007	-	2002
CADILLAC	EL DORADO	V-8, 4.6 L	2002	-	2000
CHRYSLER	TOWN & COUNTRY	V-6, 3.8 L	2005	-	2005
DODGE	CARAVAN	V-6, 3.3 L	2007	-	2004
CHRYSLER	TOWN & COUNTRY	V-6, 3.8 L	2007	-	2001
DODGE	CHARGER	V-8, 5.7 L	2008	-	2009
CHRYSLER	300 C	V-8, 5.7 L	2006	-	2009
JEEP	COMMANDER	V-8, 5.7 L	2009	-	2009
CADILLAC	DEVILLE	V-8, 4.6 L	1999	-	1997
CHRYSLER	300 C	V-6, 3.5 L	2006	-	2009
CHRYSLER	300 C	V-8, 6.1 L	2006	-	2005
CHRYSLER	VOYAGER	V-6, 3.3 L	2005	-	2005
JEEP	WRANGLER	V-6, 3.8 L	2010	-	2010
CHRYSLER	VOYAGER	V-6, 3.8 L	2005	-	2005
MAZDA	MAZDA 6	V-6, 3.0 L	2007	-	2008

### K060827

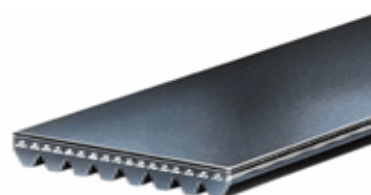

FORD	ESCAPE	4 CIL, 2.0 L	2002	-	2001
FORD	FOCUS	4 CIL, 2.0 L	2004	-	2003
FORD	RANGER	4 CIL, 2.3 L	2007	-	2001
FORD	CONTOUR	4 CIL, 2.0 L	2000	-	1999
FORD	WINDSTAR	V-6, 3.0 L	1998	-	1998
MERCURY	MYSTIQUE	4 CIL, 2.0 L	2000	-	1999

### K060828





## Aplicación por Producto

FORD	RANGER	4 CIL, 2.3 L	2008 - 2010
------	--------	--------------	-------------

### K060832

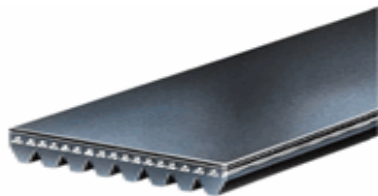

PORSCHE	BOXSTER	6 CIL, 3.2 L	2002 - 2000
FORD	F SERIES PICKUP	V-6, 4.2 L	2001 - 1998
FORD	FOCUS	4 CIL, 2.0 L	2004 - 2004
PORSCHE	BOXSTER	6 CIL, 2.7 L	2002 - 2006
FORD	LOBO	V-8, 4.6 L	2004 - 2004
FORD	LOBO	V-8, 5.4 L	2004 - 2004
PORSCHE	BOXSTER	6 CIL, 2.5 L	2000 - 1999
FORD	CONTOUR	4 CIL, 2.0 L	1998 - 1998
MERCURY	MYSTIQUE	4 CIL, 2.0 L	1998 - 1998
PORSCHE	911	6 CIL, 3.6 L	2002 - 2002
FORD	F-150	V-6, 4.2 L	1999 - 1998
CHEVROLET	CAMARO Z28	V-6, 3.8 L	1997 - 1996
PORSCHE	911	6 CIL, 3.4 L	2001 - 1999

### K060837

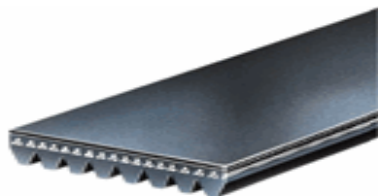

CHEVROLET	VECTRA	V-6, 2.8 L	2008 - 2007
FORD	FOCUS	4 CIL, 2.0 L	2004 - 2000
SAAB	9 - 3	V-6, 2.8 L	2007 - 2006

### K060840

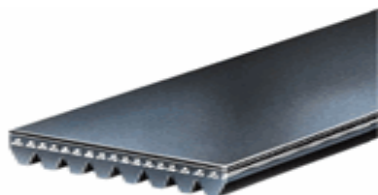

ACURA	MDX	V-6, 3.7 L	2008 - 2007
HONDA	ACCORD	V-6, 3.0 L	2007 - 2003
HONDA	RIDGELINE	V-6, 3.5 L	2007 - 2010
FORD	F-250	V-8, 4.6 L	2006 - 2005
HONDA	ACCORD	V-6, 3.5 L	2008 - 2010
VOLKSWAGEN	EUROVAN	5 CIL, 2.5 L	2003 - 2001
ACURA	RL	V-6, 3.7 L	2009 - 2010

MERCURY	MARINER	V-6, 3.0 L	2007 - 2007
ACURA	RL	V-6, 3.5 L	2008 - 2006
ACURA	TL	V-6, 3.2 L	2008 - 2006
ACURA	MDX	V-6, 3.5 L	2006 - 2006
ACURA	TL	V-6, 3.5 L	2008 - 2008
FORD	FOCUS	4 CIL, 2.0 L	2006 - 2005
HONDA	ACCORD	V-6, 3.0 L	2004 - 2004
HONDA	PILOT	V-6, 3.5 L	2007 - 2010
HONDA	ODYSSEY	V-6, 3.5 L	2007 - 2010
LINCOLN	MARK LT	V-8, 5.4 L	2007 - 2008
FORD	ESCAPE	V-6, 3.0 L	2007 - 2006
FORD	FIVE HUNDRED	V-6, 3.0 L	2005 - 2005
FORD	LOBO	V-8, 4.6 L	2006 - 2008
FORD	FIVE HUNDRED	V-6, 3.0 L	2007 - 2006
FORD	LOBO	V-8, 5.4 L	2007 - 2008
FORD	ESCAPE	V-6, 3.0 L	2005 - 2005
FORD	F-150	V-8, 4.6 L	2008 - 2008

### K060845

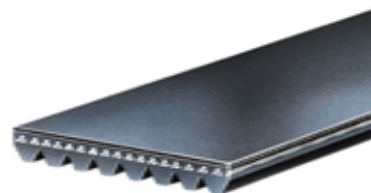

ALFA ROMEO	ALFA BRERA	V-6, 3.2 L	2007 - 2006
------------	------------	------------	-------------

### K060849



MERCEDES BE	C230	4 CIL, 2.3 L	1998 - 1998
JEEP	WRANGLER	4 CIL, 2.4 L	2006 - 2004
MERCURY	SABLE / TAURUS	V-6, 3.0 L	1997 - 1997

### K060854

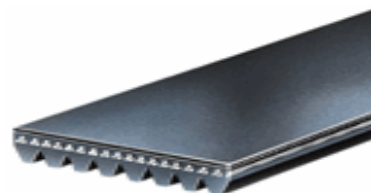

MERCURY	MARINER	4 CIL, 2.3 L	2007 - 2005
FORD	ESCORT	4 CIL, 2.0 L	2001 - 1998
FORD	EXPLORER	V-6, 4.0 L	2007 - 2004

## Aplicación por Producto

FORD	ESCAPE	4 CIL, 2.3 L	2007	-	2005
SUZUKI	GRAND VITARA	V-6, 3.2 L	2009	-	2010
MERCURY	SABLE / TAURUS	V-6, 3.0 L	2005	-	1996
FORD	EXPLORER	V-8, 4.6 L	2004	-	2004
FORD	ZX2	4 CIL, 2.0 L	2002	-	2001
MAZDA	MX-5 MIATA	4 CIL, 2.0 L	2007	-	2006
FORD	WINDSTAR	V-6, 3.0 L	1998	-	1998

### K060863

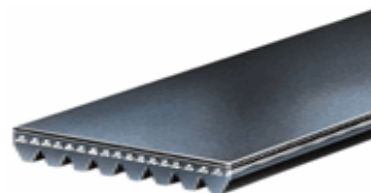

CHEVROLET	VENTURE	V-6, 3.4 L	2001	-	2001
PONTIAC	AZTEK	V-6, 3.4 L	2001	-	2001

### K060864

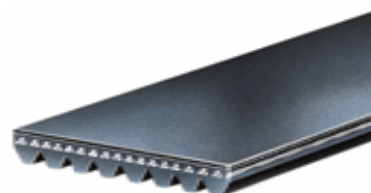

CHEVROLET	VENTURE	V-6, 3.4 L	2004	-	2001
FORD	AEROSTAR	V-6, 4.0 L	1997	-	1996
CHEVROLET	MALIBU	V-6, 3.1 L	2003	-	2002
CHEVROLET	VENTURE	V-6, 3.4 L	2005	-	2005
PONTIAC	AZTEK	V-6, 3.4 L	2005	-	2005
FORD	EXPLORER	V-6, 4.0 L	2000	-	1997
PONTIAC	AZTEK	V-6, 3.4 L	2004	-	2001
PONTIAC	GRAND AM	V-6, 3.4 L	2003	-	2002

### K060866

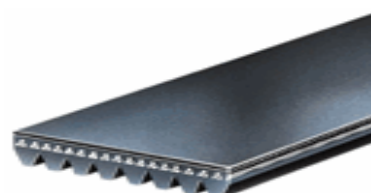

DODGE	NITRO	V-6, 4.0 L	2008	-	2010
FORD	EXPLORER	V-6, 4.0 L	2007	-	2005

### K060868

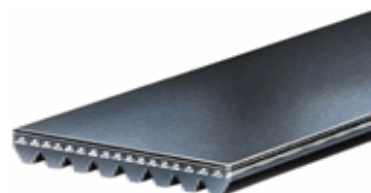

FORD	EXPLORER	V-6, 4.0 L	2001	-	2000
PONTIAC	GRAND AM	V-6, 3.4 L	2001	-	1999
JEEP	GRAND CHEROKEE	V-8, 4.7 L	2007	-	2005
FORD	FUSION	4 CIL, 2.5 L	2010	-	2010

### K060856

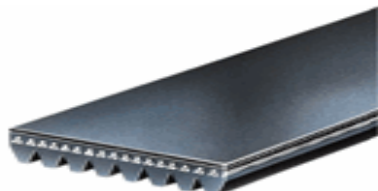

FORD	KA	4 CIL, 1.6 L	2003	-	2001
FORD	FIESTA	4 CIL, 1.6 L	2008	-	2010
FORD	COURIER	4 CIL, 1.6 L	2006	-	2007

### K060858

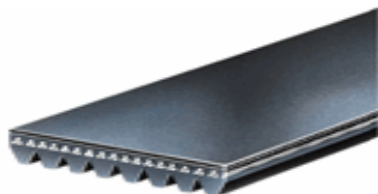

MERCURY	SABLE / TAURUS	V-6, 3.0 L	2002	-	1998
MERCURY	MYSTIQUE	4 CIL, 2.0 L	1998	-	1998
FORD	CONTOUR	4 CIL, 2.0 L	1998	-	1998
FORD	EXPLORER	V-6, 4.0 L	2003	-	2002
FORD	RANGER	V-6, 3.0 L	2002	-	1996
FORD	RANGER F-100	V-6, 3.0 L	2000	-	1997

### K060860

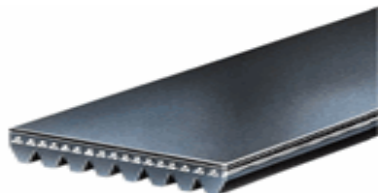

FORD	EXPLORER	V-6, 4.0 L	2007	-	2010
FORD	EXPLORER SPORT TRAC	V-6, 4.0 L	2007	-	2010
FORD	ESCAPE	4 CIL, 2.5 L	2009	-	2010

## Aplicación por Producto

CHEVROLET	EXPRESS CARGO VAN	V-6, 4.3 L	2007 - 2008
DODGE	NITRO	V-6, 3.7 L	2008 - 2010
FORD	MUSTANG SHELBY	V-8, 5.4 L	2009 - 2010
CHEVROLET	SILVERADO	V-6, 4.3 L	2007 - 1999
JEEP	GRAND CHEROKEE	V-6, 3.7 L	2007 - 2005
DODGE	DURANGO	V-8, 4.7 L	2006 - 2004
DODGE	DURANGO	V-6, 3.7 L	2005 - 2005
CHEVROLET	MALIBU	V-6, 3.1 L	2001 - 1998
JEEP	LIBERTY	V-6, 3.7 L	2005 - 2005
FORD	EXPLORER SPORT TRAC	V-6, 4.0 L	2006 - 2001
DODGE	DURANGO	V-8, 4.7 L	2005 - 2005
JEEP	LIBERTY	V-6, 3.7 L	2007 - 2009
MERCURY	MILAN	4 CIL, 2.5 L	2010 - 2010
CHEVROLET	EXPRESS CARGO VAN	V-6, 4.3 L	2006 - 2004

CHEVROLET	MALIBU	V-6, 3.1 L	2003 - 2003
CHEVROLET	EXPRESS	V-8, 5.7 L	2002 - 1999
CHEVROLET	C y K SERIES PICKUP	V-6, 4.3 L	1998 - 1996

### K060874

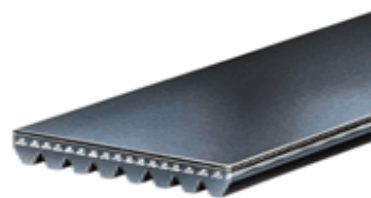

JEEP	GRAND CHEROKEE	V-8, 4.0 L	2001 - 2000
JEEP	LIBERTY	V-6, 3.7 L	2003 - 2002
JEEP	GRAND CHEROKEE	V-8, 4.7 L	2003 - 1999
FORD	FOCUS	4 CIL, 2.0 L	2006 - 2006
FORD	FOCUS	4 CIL, 2.0 L	2005 - 2005
CHEVROLET	VENTURE	V-6, 3.4 L	2000 - 1999

### K060875



CHEVROLET	EXPRESS CARGO VAN	V-6, 4.3 L	2006 - 2004
CHEVROLET	C-2500	V-8, 5.7 L	2000 - 1996
CHEVROLET	EXPRESS CARGO VAN	V-6, 4.3 L	2007 - 2010
CHEVROLET	EXPRESS CARGO VAN	V-8, 5.7 L	2000 - 1998
FORD	MUSTANG	V-6, 4.0 L	2007 - 2010
CHEVROLET	EXPRESS VAN	V-6, 4.3 L	2000 - 1998
CHEVROLET	VENTURE	V-6, 3.4 L	2004 - 2001
CHEVROLET	SUBURBAN	V-8, 5.7 L	2000 - 1997
CHEVROLET	C-3500	V-8, 5.7 L	2000 - 1996
CHEVROLET	C y K SERIES PICKUP	V-8, 5.0 L	1999 - 1999
CHEVROLET	EXPRESS VAN LUJO	V-8, 5.7 L	2000 - 1998
CHEVROLET	C y K SERIES PICKUP	V-6, 4.3 L	1998 - 1997
CHEVROLET	C-1500	V-6, 4.3 L	1998 - 1997
CHEVROLET	EXPRESS VAN PASAJEROS	V-6, 4.3 L	2000 - 1998
CHEVROLET	EXPRESS	V-6, 4.3 L	2003 - 1999
CHEVROLET	C y K SERIES PICKUP	V-8, 5.7 L	2000 - 1997
CHEVROLET	400SS	V-8, 5.7 L	2000 - 1997
CHEVROLET	CHEYENNE	V-8, 5.7 L	2000 - 1997
CHEVROLET	EXPRESS VAN PASAJEROS	V-8, 5.7 L	2000 - 1998
CHEVROLET	EXPRESS	V-8, 5.7 L	2002 - 1999
CHEVROLET	C-1500	V-8, 5.7 L	2000 - 1997
CHEVROLET	P-30	V-6, 4.3 L	1999 - 1997
CHEVROLET	EXPRESS	V-8, 5.0 L	2002 - 1999
CHEVROLET	VENTURE	V-6, 3.4 L	2005 - 2005

### K060870

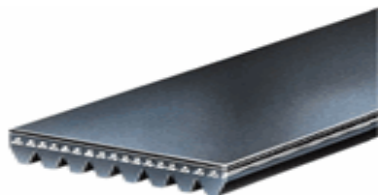

CHEVROLET	EXPRESS	V-6, 4.3 L	2003 - 1999
CHEVROLET	P-30	V-8, 5.7 L	1996 - 1996
CHEVROLET	S-10	V-6, 4.3 L	2002 - 1996
VOLKSWAGEN	EUROVAN	5 CIL, 2.5 L	2004 - 2001
CHEVROLET	C-1500	V-6, 4.3 L	1998 - 1996
CHEVROLET	EXPRESS	V-8, 5.0 L	2002 - 1999
CHEVROLET	P-30	V-6, 4.3 L	1999 - 1996
VOLKSWAGEN	EUROVAN	5 CIL, 2.5 L	2005 - 2005
CHEVROLET	400SS	V-8, 5.7 L	2000 - 1996
CHEVROLET	BLAZER	V-6, 4.3 L	2005 - 2005
PONTIAC	GRAND AM	V-6, 3.4 L	2005 - 2005
FORD	RANGER F-100	V-6, 3.0 L	1996 - 1996
CHEVROLET	C-3500	V-8, 5.7 L	2000 - 1996
CHEVROLET	C y K SERIES PICKUP	V-8, 5.0 L	1999 - 1999
CHEVROLET	EXPRESS VAN	V-6, 4.3 L	2000 - 1998
CADILLAC	CTS	V-6, 3.2 L	2003 - 2003
CHEVROLET	C-2500	V-8, 5.7 L	2000 - 1996
CHEVROLET	SUBURBAN	V-8, 5.7 L	2000 - 1996
CADILLAC	CTS	V-6, 3.2 L	2004 - 2004
CHEVROLET	CHEYENNE	V-8, 5.7 L	2000 - 1996
CHEVROLET	BLAZER	V-6, 4.3 L	2004 - 1996
CHEVROLET	EXPRESS CARGO VAN	V-8, 5.7 L	2000 - 1998
CADILLAC	CTS	V-6, 3.6 L	2006 - 2006
CHEVROLET	EXPRESS VAN LUJO	V-8, 5.7 L	2000 - 1998
CHEVROLET	EXPRESS VAN PASAJEROS	V-6, 4.3 L	2000 - 1998
CHEVROLET	C-1500	V-8, 5.7 L	2000 - 1996
CHEVROLET	C y K SERIES PICKUP	V-8, 5.7 L	2000 - 1996
PONTIAC	GRAND AM	V-6, 3.4 L	2004 - 2004
CHEVROLET	EXPRESS VAN PASAJEROS	V-8, 5.7 L	2000 - 1998

## Aplicación por Producto

### K060876

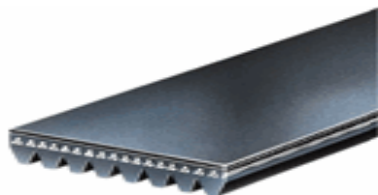

CHEVROLET	P-30	V-8, 5.7 L	1996	-	1996
CHEVROLET	EXPRESS CARGO VAN	V-6, 4.3 L	2006	-	2005
DODGE	RAM 1500	V-6, 3.7 L	2005	-	2007
DODGE	RAM 2500	V-8, 4.7 L	2004	-	2007
DODGE	DAKOTA	V-6, 3.7 L	2008	-	2007
FORD	FOCUS	4 CIL, 2.0 L	2008	-	2010

### K060878

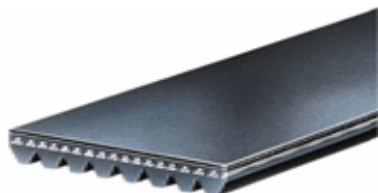

FORD	FOCUS	4 CIL, 2.0 L	2006	-	2005
FORD	MONDEO	4 CIL, 2.0 L	2006	-	2003
FORD	ECOSPORT	4 CIL, 2.0 L	2005	-	2005
FORD	ECOSPORT	4 CIL, 2.0 L	2007	-	2010
DODGE	DURANGO	V-8, 4.7 L	2001	-	2000
NISSAN	ALTIMA	4 CIL, 2.5 L	2008	-	2010
CHEVROLET	SILVERADO	V-6, 4.3 L	2008	-	2010
TOYOTA	TUNDRA	V-8, 4.7 L	2008	-	2007
CHEVROLET	EXPRESS CARGO VAN	V-6, 4.3 L	2009	-	2010

### K060882

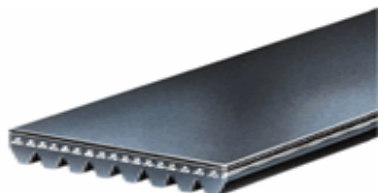

FORD	IKON	4 CIL, 1.6 L	2005	-	2005
TOYOTA	LAND CRUISER	V-8, 4.7 L	2005	-	2005
TOYOTA	LAND CRUISER	V-8, 4.7 L	2007	-	2003
TOYOTA	SEQUOIA	V-8, 4.7 L	2008	-	2007
FORD	FIESTA	4 CIL, 1.6 L	2004	-	2010
FORD	COURIER	4 CIL, 1.6 L	2006	-	2007
FORD	RANGER F-100	V-6, 3.0 L	2000	-	1997
JEEP	GRAND CHEROKEE	6 CIL, 4.0 L	2002	-	1999
FORD	RANGER	V-6, 4.0 L	2001	-	1999
FORD	RANGER	V-6, 3.0 L	2002	-	1996

FORD	IKON	4 CIL, 1.6 L	2004	-	2007
FORD	KA	4 CIL, 1.6 L	2005	-	2005
FORD	KA	4 CIL, 1.6 L	2004	-	2007
FORD	FUSION	4 CIL, 2.3 L	2007	-	2009
JEEP	WRANGLER	V-6, 4.0 L	2004	-	2004
CHEVROLET	MALIBU	V-6, 3.5 L	2005	-	2005
CHEVROLET	MALIBU	V-6, 3.5 L	2006	-	2004
DODGE	DURANGO	V-8, 4.7 L	2003	-	2002
DODGE	RAM 1500	V-6, 3.7 L	2003	-	2002
DODGE	RAM 2500	V-8, 4.7 L	2003	-	2003
DODGE	RAM 2500	V-8, 4.7L	2002	-	2002
FORD	EXPLORER	V-6, 4.0 L	2000	-	1998
PONTIAC	G6	V-6, 3.5 L	2006	-	2006
TOYOTA	4 RUNNER	V-8, 4.7 L	2005	-	2005
JEEP	WRANGLER	6 CIL, 4.0 L	2006	-	2000
JEEP	WRANGLER	6 CIL, 4.0 L	2005	-	2005
DODGE	RAM SERIES PICKUP	V-6, 3.7 L	2003	-	2002
DODGE	RAM SERIES PICKUP	V-8, 4.7L	2003	-	2002
JEEP	GRAND CHEROKEE	V-8, 4.0 L	2001	-	1999
JEEP	GRAND CHEROKEE	V-6, 4.0 L	2004	-	2003
TOYOTA	4 RUNNER	V-8, 4.7 L	2006	-	2003
MAZDA	MX-5 MIATA	4 CIL, 2.0 L	2007	-	2006

### K060883



MAZDA	MAZDA 6	4 CIL, 2.3 L	2007	-	2006
NISSAN	ALTIMA	4 CIL, 2.5 L	2006	-	2003
FORD	FUSION	4 CIL, 2.3 L	2007	-	2009
NISSAN	ALTIMA	4 CIL, 2.4 L	2004	-	2004
NISSAN	SENTRA	4 CIL, 2.5 L	2006	-	2003
NISSAN	X-TRAIL	4 CIL, 2.4 L	2007	-	2004

### K060886

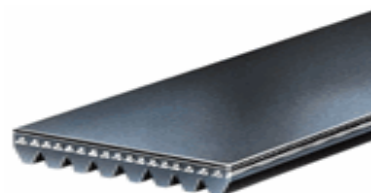

MAZDA	MAZDA 6	4 CIL, 2.3 L	2008	-	2008
MAZDA	MAZDA 3	4 CIL, 2.3 L	2010	-	2010

### K060888

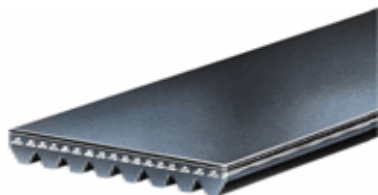

CHEVROLET	UPLANDER	V-6, 3.5 L	2005	-	2005
DODGE	RAM 1500	V-6, 3.7 L	2008	-	2009
CHEVROLET	UPLANDER	V-6, 3.5 L	2007	-	2006
JEEP	GRAND CHEROKEE	V-6, 3.7 L	2008	-	2009
PONTIAC	MONTANA	V-6, 3.5 L	2006	-	2006
VOLKSWAGEN	POINTER	4 CIL, 1.8 L	2001	-	1999
DODGE	RAM 2500	V-8, 4.7 L	2008	-	2009
VOLKSWAGEN	POINTER PICK-UP	4 CIL, 1.8 L	2001	-	1999
DODGE	DAKOTA	V-6, 3.7 L	2009	-	2009
MERCEDES BE	SPRINTER	4 CIL, 2.2 L CDI	2007	-	2010
NISSAN	X-TRAIL	4 CIL, 2.4 L	2003	-	2003
MERCEDES BE	VITO	4 CIL, 2.2 L	2008	-	2010
VOLKSWAGEN	POINTER STATION WAGON	4 CIL, 1.8 L	2001	-	1999

### K060895

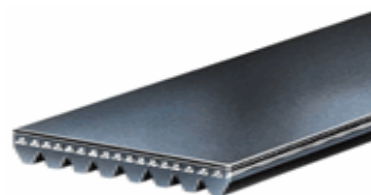

FORD	ESCAPE	4 CIL, 2.3 L	2007	-	2005
FORD	F SERIES PICKUP	V-6, 4.2 L	2001	-	1998
FORD	F-150	V-6, 4.2 L	1999	-	1998
FORD	RANGER F-100	V-6, 3.0 L	1996	-	1996
JEEP	CHEROKEE	6 CIL, 4.0 L	2000	-	2000
MERCEDES BE	SPRINTER	5 CIL, 2.7 L CDI	2005	-	2003
VOLKSWAGEN	CARAVELLE	4 CIL, 1.8 L	1996	-	1996
VOLKSWAGEN	POINTER PICK-UP	4 CIL, 1.8 L	2004	-	2002
VOLKSWAGEN	POINTER PICK-UP	4 CIL, 1.8 L	2005	-	2005
MERCURY	MARINER	4 CIL, 2.3 L	2007	-	2005

### K060900

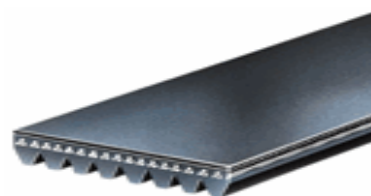

MERCEDES BE	VITO	4 CIL, 2.2 L	2008	-	2010
CHEVROLET	UPLANDER	V-6, 3.5 L	2007	-	2006
CHEVROLET	UPLANDER	V-6, 3.5 L	2005	-	2005
MAZDA	CX-7	4 CIL, 2.3 L	2008	-	2006
MERCEDES BE	SPRINTER	4 CIL, 2.2 L CDI	2008	-	2010
JEEP	WRANGLER	V-6, 3.8 L	2007	-	2010

### K060891

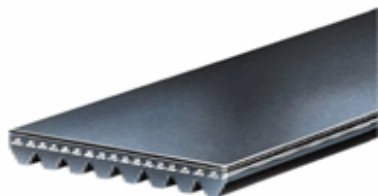

FORD	FUSION	4 CIL, 2.3 L	2008	-	2007
------	--------	--------------	------	---	------

### K060894

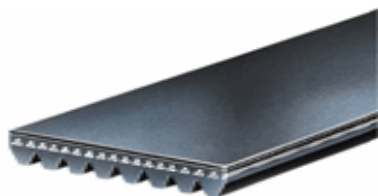

VOLKSWAGEN	POINTER	4 CIL, 1.8 L	2005	-	2005
VOLKSWAGEN	POINTER	4 CIL, 2.0 L	2005	-	2006
VOLKSWAGEN	POINTER	4 CIL, 1.8 L	2008	-	2002

### K060905



CHEVROLET	EQUINOX	V-6, 3.4 L	2007	-	2006
CHEVROLET	MONTE CARLO	V-6, 3.8 L	2005	-	2004
PONTIAC	TORRENT	V-6, 3.4 L	2008	-	2006
CHEVROLET	TRAILBLAZER	6 CIL, 4.2 L	2005	-	2005
CHEVROLET	IMPALA	V-6, 3.8 L	2005	-	2005
PONTIAC	GRAND PRIX	V-6, 3.8 L	2005	-	2003
CHEVROLET	IMPALA	V-6, 3.8 L	2004	-	2004
CHEVROLET	TRAILBLAZER	6 CIL, 4.2 L	2007	-	2002



## Aplicación por Producto

### K060908

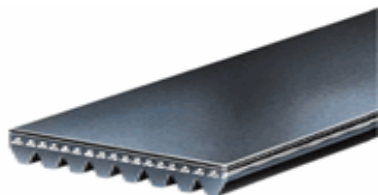

MERCURY	GRAND MARQUIS	V-8, 4.6 L	2005	-	2005
LINCOLN	TOWN CAR	V-8, 4.6 L	2006	-	2003
FORD	CROWN VICTORIA	V-8, 4.6 L	2004	-	2003

### K060910

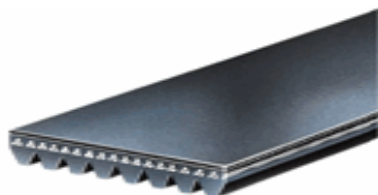

JEEP	CHEROKEE	6 CIL, 4.0 L	1999	-	1998
MAZDA	MAZDA 6	4 CIL, 2.3 L	2007	-	2006
JEEP	WRANGLER	4 CIL, 2.5 L	2000	-	1997
FORD	MONDEO	V-6, 2.5 L	2003	-	2003
JEEP	CHEROKEE	4 CIL, 2.5 L	1998	-	1996
MERCURY	GRAND MARQUIS	V-8, 4.6 L	2004	-	2003
MAZDA	MAZDA 3	4 CIL, 2.3 L	2008	-	2006
LINCOLN	LS	V-8, 3.9 L	2006	-	2003
FORD	MONDEO	4 CIL, 2.0 L	2003	-	2003

### K060915

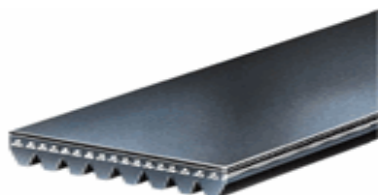

GMC	CANYON	5 CIL, 3.7 L	2008	-	2010
FORD	CROWN VICTORIA	V-8, 4.6 L	2002	-	2000
CHEVROLET	TRAILBLAZER	6 CIL, 4.2 L	2007	-	2002
LINCOLN	TOWN CAR	V-8, 4.6 L	2001	-	2000
HUMMER	H3	5 CIL, 3.7 L	2008	-	2010
CHEVROLET	TRAILBLAZER	6 CIL, 4.2 L	2005	-	2005
HUMMER	H3	5 CIL, 3.5 L	2007	-	2006
CHEVROLET	COLORADO	4 CIL, 2.8 L	2005	-	2005
CHEVROLET	COLORADO	4 CIL, 2.8 L	2006	-	2006
CHEVROLET	COLORADO	5 CIL, 3.5 L	2006	-	2005
CHEVROLET	COLORADO	5 CIL, 3.5 L	2004	-	2004
MERCURY	GRAND MARQUIS	V-8, 4.6 L	2001	-	2000
CHEVROLET	COLORADO	5 CIL, 3.7 L	2007	-	2010

PONTIAC	GRAND PRIX	V-6, 3.8 L	2002	-	1999
CHEVROLET	IMPALA	V-6, 3.8 L	2002	-	2000
CHEVROLET	COLORADO	4 CIL, 2.9 L	2007	-	2010

### K060919



CHEVROLET	IMPALA	V-6, 3.8 L	2003	-	2003
CHEVROLET	EQUINOX	V-6, 3.4 L	2007	-	2005
FORD	ESCAPE	V-6, 3.0 L	2008	-	2009
LINCOLN	TOWN CAR	V-8, 4.6 L	2002	-	2002
FORD	ESCAPE	4 CIL, 2.3 L	2008	-	2008
MERCURY	MARINER	V-6, 3.0 L	2008	-	2008
JEEP	WRANGLER	4 CIL, 2.4 L	2006	-	2003
MERCURY	GRAND MARQUIS	V-8, 4.6 L	2002	-	2002
CHEVROLET	EXPRESS	V-8, 7.4 L	2000	-	1999
JEEP	WRANGLER	6 CIL, 4.0 L	1999	-	1999
FORD	FUSION	V-6, 3.0 L	2008	-	2009
JEEP	GRAND CHEROKEE	6 CIL, 4.0 L	1998	-	1996
CHEVROLET	C y K SERIES PICKUP	V-8, 7.4 L	2000	-	1999
MERCURY	MILAN	V-6, 3.0 L	2007	-	2009

### K060923



CHEVROLET	AVALANCHE	V-8, 5.3 L	2004	-	2002
CADILLAC	ESCALADE	V-8, 6.0 L	2005	-	2005
CADILLAC	ESCALADE	V-8, 6.0 L	2006	-	2002
CHEVROLET	TAHOE	V-8, 5.3 L	2007	-	2006
CHEVROLET	SUBURBAN	V-8, 5.3 L	2007	-	2000
CADILLAC	ESCALADE	V-8, 5.3 L	2004	-	2002
CHEVROLET	REGAL	V-6, 3.8 L	1996	-	1996
JEEP	WRANGLER	4 CIL, 2.5 L	2002	-	2001
PONTIAC	BONNEVILLE	V-6, 3.8 L	2000	-	2000
CHEVROLET	EXPRESS	V-8, 6.0 L	2007	-	2010
CHEVROLET	SUBURBAN	V-8, 6.0 L	2002	-	2003
CHEVROLET	TRAILBLAZER	V-8, 5.3 L	2007	-	2003
CHEVROLET	SILVERADO	V-8, 5.3 L	2007	-	2000
CHEVROLET	SILVERADO	V-8, 6.0 L	2007	-	2000
LINCOLN	TOWN CAR	V-8, 4.6 L	2006	-	2006
JEEP	WRANGLER	6 CIL, 4.0 L	1999	-	1999

## Aplicación por Producto

CHEVROLET	TRAILBLAZER	V-8, 5.3 L	2005	-	2005
CHEVROLET	SONORA	V-8, 5.3 L	2003	-	2003
CHEVROLET	AVALANCHE	V-8, 5.3 L	2006	-	2005
SAAB	9 - 3	4 CIL, 2.0 L	2002	-	1999
SAAB	9 - 3	4 CIL, 2.3 L	2002	-	2000
MERCEDES BE	CL600	V-12, 5.8 L	2001	-	2001
CHEVROLET	EXPRESS	V-8, 5.3 L	2007	-	2008
CHEVROLET	SILVERADO	V-8, 4.8 L	2007	-	2001
JEEP	GRAND CHEROKEE	6 CIL, 4.0 L	1998	-	1998
MERCEDES BE	S600	V-12, 5.8 L	2001	-	2001

### K060935

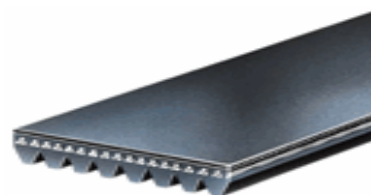

CHEVROLET	C y K SERIES PICKUP	V-8, 8.1 L	2002	-	2001
FORD	F-250 XL	V-8, 5.8 L	1996	-	1996
CHEVROLET	TRAILBLAZER	V-8, 6.0 L	2006	-	2006
CHEVROLET	TAHOE	V-8, 4.8 L	2007	-	2006
FORD	EXPLORER	V-8, 5.4 L	2000	-	1999
CHEVROLET	MALIBU	V-6, 3.6 L	2008	-	2010
FORD	EXPLORER	V-8, 5.0 L	2000	-	1998
CHEVROLET	SILVERADO	V-8, 4.8 L	2008	-	2010
CHRYSLER	PACIFICA	V-6, 3.5 L	2006	-	2004
CADILLAC	ESCALADE	V-8 6.2 L	2008	-	2010
CHEVROLET	TAHOE	V-8, 5.3 L	2008	-	2010
CHEVROLET	SILVERADO	V-8, 5.3 L	2008	-	2010
PONTIAC	GRAND PRIX	V-6, 3.8 L	1998	-	1997
FORD	MUSTANG	V-8, 4.6 L	2004	-	2000
CHRYSLER	PACIFICA	V-6, 3.5 L	2005	-	2005
CHEVROLET	SUBURBAN	V-8, 5.3 L	2008	-	2010
GMC	SIERRA	V-8, 5.3 L	2009	-	2010
GMC	SIERRA	V-8, 6.2 L	2008	-	2010
GMC	YUKON	V-8, 5.3 L	2008	-	2007
GMC	YUKON	V-8, 6.2 L	2008	-	2010
CHEVROLET	EXPRESS	V-8, 5.3 L	2009	-	2010
CHEVROLET	SUBURBAN	V-8, 6.0 L	2008	-	2010
HUMMER	H2	V-8, 6.2 L	2008	-	2010
PONTIAC	G6	V-6, 3.6 L	2008	-	2007
CADILLAC	ESCALADE	V-8, 6.2 L	2007	-	2007
CHEVROLET	AVALANCHE	V-8, 5.3 L	2007	-	2010
CHEVROLET	EXPRESS	V-8, 8.1 L	2002	-	2001

### K060926

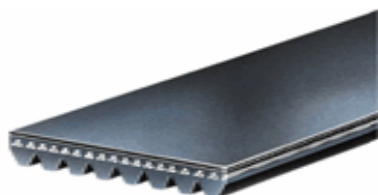

PONTIAC	BONNEVILLE	V-6, 3.8 L	2005	-	2000
---------	------------	------------	------	---	------

### K060930

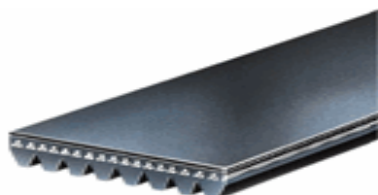

CHEVROLET	AVALANCHE	V-8, 5.3 L	2006	-	2005
CHEVROLET	SILVERADO	V-8, 5.3 L	2007	-	2000
CADILLAC	ESCALADE	V-8, 5.3 L	2004	-	2002
CHEVROLET	EXPRESS	V-8, 6.0 L	2007	-	2010
CHEVROLET	AVALANCHE	V-8, 5.3 L	2004	-	2002
CADILLAC	ESCALADE	V-8, 6.0 L	2005	-	2005
CHEVROLET	SONORA	V-8, 5.3 L	2003	-	2003
CHEVROLET	EXPRESS	V-8, 8.1 L	2002	-	2001
CHEVROLET	SILVERADO	V-8, 4.8 L	2007	-	2001
PONTIAC	GRAND PRIX	V-6, 3.8 L	1998	-	1997
CHEVROLET	SUBURBAN	V-8, 5.3 L	2007	-	2000
CHEVROLET	EXPRESS	V-8, 5.3 L	2007	-	2010
CHEVROLET	SILVERADO	V-8, 6.0 L	2007	-	2000
HUMMER	H2	V-8, 6.0 L	2007	-	2005
SUZUKI	XL-7	V-6, 3.6 L	2008	-	2009
CHEVROLET	SUBURBAN	V-8, 6.0 L	2002	-	2003
CADILLAC	ESCALADE	V-8, 6.0 L	2006	-	2002
CHEVROLET	TAHOE	V-8, 5.3 L	2007	-	2006
CHEVROLET	CAPTIVA	V-6, 3.6 L	2008	-	2010
CHEVROLET	C y K SERIES PICKUP	V-8, 8.1 L	2002	-	2001

### K060938

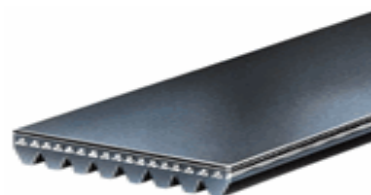

BUICK	ENCLAVE	V-6, 3.6 L	2010	-	2010
MERCEDES BE	SL500	V-8, 5.0 L	2005	-	2003
FORD	EXPLORER	V-8, 5.0 L	2001	-	2001
CHRYSLER	PACIFICA	V-6, 3.5 L	2004	-	2004
PONTIAC	BONNEVILLE	V-6, 3.8 L	1999	-	1996
MERCEDES BE	CLK55	V-8, 5.5 L	2006	-	2001
MERCEDES BE	CL55	V-8, 5.5 L	2006	-	2001

## Aplicación por Producto

MERCEDES BE	CL500	V-8, 5.0 L	2005	-	2003
MERCEDES BE	E320	V-6, 3.2 L	2006	-	2002
OLDSMOBILE	EIGHTY EIGHT	V-6, 3.8 L	1999	-	1998
PONTIAC	GRAND PRIX	V-6, 3.1 L	1999	-	1999
PONTIAC	GRAND PRIX	V-6, 3.8 L	1999	-	1999
GMC	ACADIA	V-6, 3.6 L	2008	-	2010
CHEVROLET	TRAVERSE	V-6, 3.6 L	2010	-	2011
JAGUAR	S-TYPE	V-8, 4.0 L	2005	-	2000

### K060947

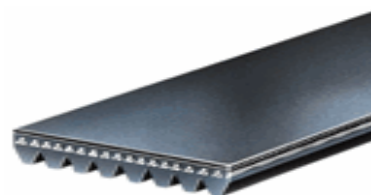

AUDI	Q5	V-6, 3.2 L	2009	-	2009
MERCEDES BE	SLK350	V-6, 3.2 L	2005	-	2005

### K060950

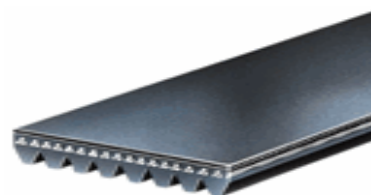

CHEVROLET	EXPRESS VAN PASAJEROS	V-8, 5.7 L	2000	-	1998
CHEVROLET	EXPRESS VAN PASAJEROS	V-6, 4.3 L	2000	-	1998
AUDI	A4	V-6, 3.2 L	2007	-	2009
CHEVROLET	EXPRESS CARGO VAN	V-6, 4.3 L	2006	-	2004
CHEVROLET	BLAZER	V-6, 4.3 L	2005	-	2005
CHEVROLET	SUBURBAN	V-8, 8.1 L	2002	-	2003
JEEP	CHEROKEE	6 CIL, 4.0 L	2001	-	1996
CHEVROLET	AVALANCHE	V-8, 8.1 L	2002	-	2002
CHEVROLET	EXPRESS CARGO VAN	V-8, 5.7 L	2000	-	1998
JEEP	WRANGLER	6 CIL, 4.0 L	2000	-	1998
CHEVROLET	EXPRESS VAN LUJO	V-8, 5.7 L	2000	-	1998
CHEVROLET	S-10	V-6, 4.3 L	2002	-	1996
CHEVROLET	EXPRESS VAN	V-6, 4.3 L	2000	-	1998
CHEVROLET	SILVERADO	V-6, 4.3 L	2007	-	1999
CHEVROLET	BLAZER	V-6, 4.3 L	2004	-	1996
CHEVROLET	EXPRESS	V-6, 4.3 L	2003	-	1999
CHEVROLET	EXPRESS CARGO VAN	V-6, 4.3 L	2007	-	2008
CHEVROLET	SILVERADO	V-8, 8.1 L	2007	-	2001
AUDI	A6	V-6, 3.0 L	2006	-	2005
CHEVROLET	EXPRESS	V-8, 5.7 L	2002	-	1999
AUDI	A6	V-6, 3.2 L	2007	-	2008
CHEVROLET	EXPRESS	V-8, 5.0 L	2002	-	1999

### K060956

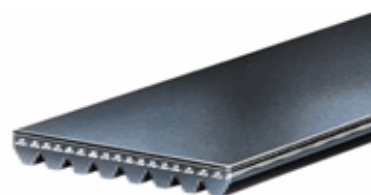

CHEVROLET	AVALANCHE	V-8, 8.1 L	2002	-	2002
-----------	-----------	------------	------	---	------

### K060942

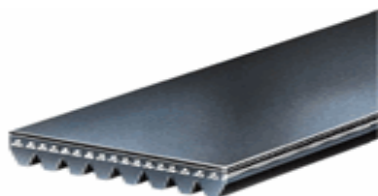

MERCEDES BE	C280	V-6, 2.8 L	2000	-	1998
MERCEDES BE	C320	V-6, 3.2 L	2005	-	2001
MERCEDES BE	C43	V-8, 4.3 L	2000	-	1999
MERCEDES BE	CL500	V-8, 5.0 L	2001	-	1999
MERCEDES BE	CL55	V-8, 5.5 L	2001	-	2001
MERCEDES BE	CLK320	V-6, 3.2 L	2005	-	1999
MERCEDES BE	CLK430	V-8, 4.3 L	2003	-	1999
MERCEDES BE	CLK55	V-8, 5.5 L	2006	-	2001
MERCEDES BE	C240	V-6, 2.6 L	2005	-	2001
MERCEDES BE	E430	V-8, 4.3 L	2001	-	1999
MERCEDES BE	E55	V-8, 5.5 L	2001	-	1999
MERCEDES BE	ML320	V-6, 3.2 L	2001	-	1999
MERCEDES BE	ML430	V-8, 4.3 L	2001	-	1999
MERCEDES BE	S430	V-8, 4.3 L	2005	-	2000
MERCEDES BE	S500	V-8, 5.0 L	2005	-	2000
MERCEDES BE	S55	V-8, 5.5 L	2002	-	2001
MERCEDES BE	SL500	V-8, 5.0 L	2002	-	1999
MERCEDES BE	SLK320	V-6, 3.2 L	2004	-	2000
MERCEDES BE	ML320	V-6, 3.2 L	2003	-	2002
MERCEDES BE	E320	V-6, 3.2 L	2001	-	1998

### K060945

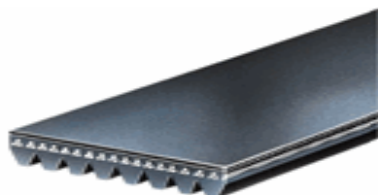

CHEVROLET	CAMARO Z28	V-6, 3.8 L	2002	-	1996
-----------	------------	------------	------	---	------

## Aplicación por Producto

SAAB	9 - 5	4 CIL, 2.3 L	2007 - 2004
CHEVROLET	SUBURBAN	V-8, 8.1 L	2002 - 2003
BUICK	LACROSSE	V-6, 3.6 L	2010 - 2010
CHEVROLET	SILVERADO	V-8, 8.1 L	2007 - 2001

CHEVROLET	P-30	V-8, 5.7 L	1996 - 1996
FORD	F SERIES PICKUP	V-6, 4.2 L	2001 - 1998
DODGE	ADVENTURER	V-6, 3.3 L	2000 - 1996
CHEVROLET	C y K SERIES PICKUP	V-8, 5.0 L	1999 - 1999
CADILLAC	ESCALADE	V-8, 5.7 L	2000 - 1999
CHRYSLER	VOYAGER	V-6, 3.3 L	2000 - 1996
DODGE	CARAVAN	V-6, 3.3 L	2000 - 2000
CHEVROLET	C y K SERIES PICKUP	V-6, 4.3 L	1996 - 1996
CHRYSLER	TOWN & COUNTRY	V-6, 3.8 L	2000 - 1998
CHEVROLET	400SS	V-8, 5.7 L	2000 - 1996
CHRYSLER	GRAND VOYAGER	V-6, 3.8 L	2000 - 2000
CHEVROLET	C-1500	V-8, 5.7 L	2000 - 1996
FORD	F-150	V-6, 4.2 L	2007 - 2008
CHRYSLER	TOWN & COUNTRY	V-6, 3.3 L	2000 - 1999
CHRYSLER	GRAND VOYAGER	V-6, 3.3 L	2000 - 2000
FORD	WINDSTAR	V-6, 3.8 L	2000 - 2000
CHEVROLET	C-1500	V-6, 4.3 L	1996 - 1996

### K060960

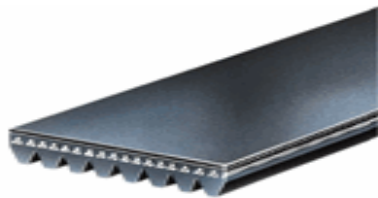

CHEVROLET	P-30	V-8, 5.7 L	1996 - 1996
FORD	MUSTANG	V-8, 4.6 L	2004 - 2002
CHEVROLET	EXPRESS	V-6, 4.3 L	2003 - 1999
CHEVROLET	C y K SERIES PICKUP	V-8, 5.7 L	2000 - 1996
CHEVROLET	EXPRESS VAN LUJO	V-8, 5.7 L	2000 - 1998
CHEVROLET	CHEYENNE	V-8, 5.7 L	2000 - 1996
CHEVROLET	C-3500	V-8, 5.7 L	2000 - 1996
FORD	FREESTAR	V-6, 4.2 L	2007 - 2004
CHEVROLET	C-2500	V-8, 5.7 L	2000 - 1996
CHEVROLET	SUBURBAN	V-8, 5.7 L	2000 - 1996
CHEVROLET	C-1500	V-8, 5.7 L	2000 - 1996
CHEVROLET	EXPRESS CARGO VAN	V-8, 5.7 L	2000 - 1998
CHEVROLET	400SS	V-8, 5.7 L	2000 - 1996
CHEVROLET	SILVERADO	V-6, 4.3 L	2008 - 2010
CHEVROLET	EXPRESS VAN	V-6, 4.3 L	2000 - 1998
CHEVROLET	C y K SERIES PICKUP	V-6, 4.3 L	1998 - 1996
CHEVROLET	EXPRESS VAN PASAJEROS	V-6, 4.3 L	2000 - 1998
CHEVROLET	EXPRESS	V-8, 5.0 L	2002 - 1999
CHEVROLET	EXPRESS	V-8, 5.7 L	2002 - 1999
CHEVROLET	EXPRESS CARGO VAN	V-6, 4.3 L	2004 - 2004
FORD	FREESTAR	V-6, 3.9 L	2007 - 2004
CHEVROLET	P-30	V-6, 4.3 L	1999 - 1996
CHEVROLET	C y K SERIES PICKUP	V-8, 5.0 L	1999 - 1999
CHEVROLET	EXPRESS CARGO VAN	V-6, 4.3 L	2007 - 2010
CHEVROLET	EXPRESS VAN PASAJEROS	V-8, 5.7 L	2000 - 1998
CHEVROLET	C-1500	V-6, 4.3 L	1998 - 1996
FORD	WINDSTAR	V-6, 3.8 L	2003 - 1999

### K060966

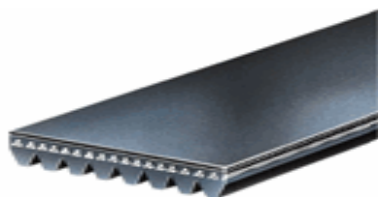

CHEVROLET	P-30	V-6, 4.3 L	1999 - 1996
CHRYSLER	VOYAGER	V-6, 3.8 L	1999 - 1999

### K060970

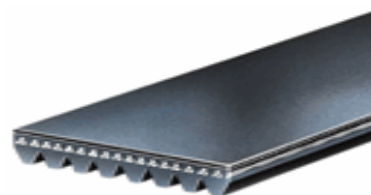

FORD	SUPER DUTY VAN	V-6, 4.2 L	2001 - 2001
MERCEDES BE	SL500	V-8, 5.0 L	2006 - 2003
FORD	E SERIES VAN	V-6, 4.2 L	2003 - 1997
FORD	F SERIES PICKUP	V-6, 4.2 L	2000 - 2000
MERCEDES BE	S55	V-8, 5.5 L	2005 - 2003

### K060975

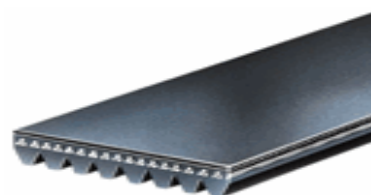

VOLKSWAGEN	TOUAREG	V-6, 3.0 L DIESEL	2009 - 2010
FORD	MUSTANG	V-8, 4.6 L	1999 - 1996

### K060984

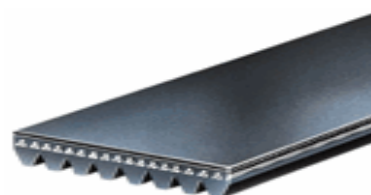

## Aplicación por Producto

FORD	EXPEDITION	V-8, 5.4 L	2002	-	2002
FORD	MUSTANG	V-6, 3.8 L	1998	-	1996
LINCOLN	NAVIGATOR	V-8, 5.4 L	2002	-	2002
FORD	EXPEDITION	V-8, 4.6 L	2002	-	2002
CHEVROLET	C y K SERIES PICKUP	V-8, 7.4 L	2000	-	1999
CHEVROLET	EXPRESS	V-8, 7.4 L	2000	-	1999

### K060994

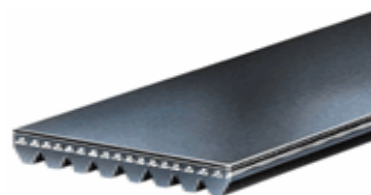

FORD	E SERIES VAN	V-8, 5.4 L	2008	-	2010
CHEVROLET	EXPRESS	V-8, 7.4 L	2000	-	1999
FORD	MUSTANG	V-8, 4.6 L	2001	-	2001
FORD	MUSTANG	V-6, 3.8 L	2001	-	1999

### K060997

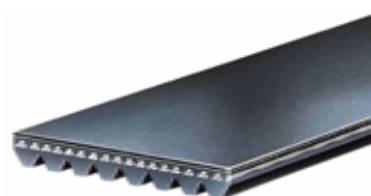

CHRYSLER	GRAND VOYAGER	V-6, 3.8 L	2000	-	2000
CHRYSLER	VOYAGER	V-6, 3.3 L	1999	-	1998
MERCEDES BE	S500	V-8, 5.0 L	1999	-	1999
CHRYSLER	VOYAGER	V-6, 3.8 L	1999	-	1999
CHRYSLER	TOWN & COUNTRY	V-6, 3.8 L	2000	-	2000
MERCEDES BE	SL500	V-8, 5.0 L	1999	-	1998
MERCEDES BE	CL500	V-8, 5.0 L	1998	-	1998
MERCEDES BE	S420	V-8, 4.2 L	1999	-	1998

FORD	E SERIES VAN	V-8, 5.4 L	2007	-	2007
FORD	F-350 SUPER DUTY	V-8, 5.4 L	2006	-	2009
FORD	SUPER DUTY PICKUP	V-10, 6.8 L	2002	-	2002
FORD	SUPER DUTY PICKUP	V-8, 5.4 L	2003	-	2002
FORD	E SERIES VAN	V-8, 4.6 L	2008	-	2010
FORD	F-450 SUPER DUTY	V-10, 6.8 L	2006	-	2007

### K061000



FORD	F-350 SUPER DUTY	V-8, 5.4 L	2010	-	2010
FORD	E SERIES VAN	V-8, 5.4 L	2006	-	2002
FORD	EXCURSION	V-8, 5.4 L	2002	-	2002
FORD	EXCURSION	V-10, 6.8 L	2005	-	2003
FORD	F-250 XL	V-8, 5.8 L	1997	-	1997
FORD	F-450 SUPER DUTY	V-10, 6.8 L	2008	-	2010
FORD	SUPER DUTY VAN	V-8, 5.4 L	2002	-	2002
FORD	E SERIES VAN	V-8, 4.6 L	2006	-	2002
FORD	SUPER DUTY VAN	V-8, 4.6 L	2003	-	2003
FORD	SUPER DUTY VAN	V-10, 6.8 L	2002	-	2002
FORD	LOBO	V-8, 4.6 L	2003	-	2002
FORD	LOBO	V-8, 5.4 L	2003	-	2003
FORD	F-250	V-8, 4.6 L	2004	-	2002
FORD	SUPER DUTY PICKUP	V-10, 6.8 L	2003	-	2003
FORD	F-550 SUPER DUTY	V-10, 6.8 L	2008	-	2010

FORD	F-350 SUPER DUTY	V-8, 5.4 L	2004	-	2002
CHEVROLET	C y K SERIES PICKUP	V-8, 7.4 L	1999	-	1999
LINCOLN	AVIATOR	V-8, 4.6 L	2003	-	2005

### K061005

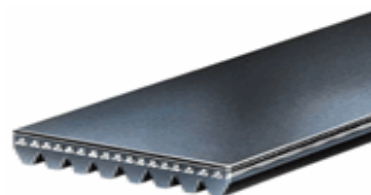

JEEP	PATRIOT	4 CIL, 2.4 L	2008	-	2010
CHEVROLET	EXPRESS	V-8, 6.5 L	2002	-	2001
CHEVROLET	C y K SERIES PICKUP	V-8, 7.4 L	2000	-	1999



## Aplicación por Producto

FORD	F-550 SUPER DUTY	V-10, 6.8 L	2008	-	2010
FORD	EXPEDITION	V-8, 5.4 L	2004	-	2003
FORD	F-350 SUPER DUTY	V-8, 5.4 L	2010	-	2010
FORD	F-450 SUPER DUTY	V-10, 6.8 L	2008	-	2010
JEEP	COMPASS	4 CIL, 2.4 L	2008	-	2010
DODGE	CALIBER	4 CIL, 2.4 L	2008	-	2009
FORD	EXPEDITION	V-8, 4.6 L	2004	-	2004

### K061020

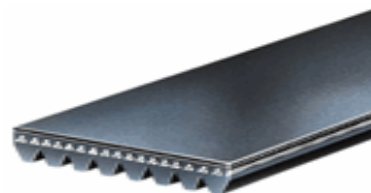

### K061010

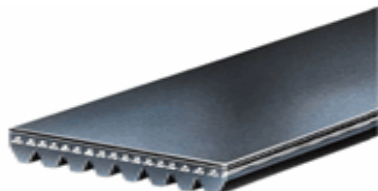

CHEVROLET	C y K SERIES PICKUP	V-8, 6.5 L	2000	-	1999
FORD	F-250 XL	V-8, 5.0 L	1997	-	1997
LINCOLN	NAVIGATOR	V-8, 5.4 L	2006	-	2006
MERCEDES BE	SL600	V-12, 6.0 L	1998	-	1998
MERCEDES BE	S600 L	V-12, 6.0 L	1999	-	1998
FORD	MUSTANG	V-8, 4.6 L	2008	-	2010
VOLKSWAGEN	CRAFTER	5 CIL, 2.5 L TDI	2008	-	2010
MERCEDES BE	CL600	V-12, 6.0 L	1998	-	1998

FORD	EXPEDITION	V-8, 4.6 L	2003	-	2003
FORD	EXPLORER	V-8, 4.6 L	2007	-	2002
CHEVROLET	C y K SERIES PICKUP	V-8, 6.5 L	2002	-	1999
PONTIAC	G8	V-6, 3.6 L	2009	-	2009
FORD	EXCURSION	V-8, 4.6 L	2003	-	2003
MITSUBISHI	LANCER	4 CIL, 2.0 L	2008	-	2008

### K061025

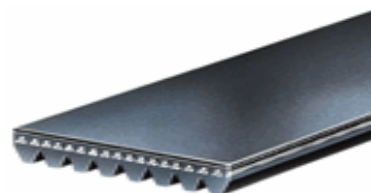

### K061015

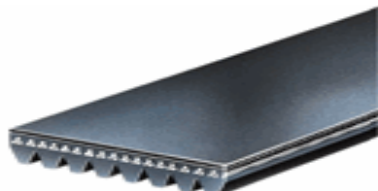

FORD	F-150	V-6, 4.2 L	2008	-	2008
FORD	EXPEDITION	V-8, 5.4 L	2005	-	2006
MERCEDES BE	SL600	V-12, 6.0 L	2001	-	1999
MERCEDES BE	S600 L	V-12, 6.0 L	2000	-	2000
MERCEDES BE	S600	V-12, 6.0 L	1999	-	1999
JEEP	COMPASS	4 CIL, 2.4 L	2008	-	2010
LINCOLN	NAVIGATOR	V-8, 5.4 L	2007	-	2003
CHEVROLET	EXPRESS	V-8, 8.1 L	2002	-	2001
FORD	MUSTANG	V-8, 4.6 L	2007	-	2006
FORD	MUSTANG	V-8, 4.6 L	2005	-	2005
CHEVROLET	EXPRESS	V-8, 6.5 L	2002	-	1999
JEEP	PATRIOT	4 CIL, 2.4 L	2008	-	2010
DODGE	CALIBER	4 CIL, 2.4 L	2009	-	2009
MERCEDES BE	CL600	V-12, 6.0 L	1999	-	1999
DODGE	CALIBER	4 CIL, 2.4 L	2008	-	2007
DODGE	JOURNEY	4 CIL, 2.4 L	2009	-	2010
DODGE	AVENGER	4 CIL, 2.0 L	2008	-	2009
DODGE	AVENGER	4 CIL, 2.4 L	2008	-	2009

FORD	EXPLORER SPORT TRAC	V-8, 4.6 L	2007	-	2010
FORD	F SERIES PICKUP	V-6, 4.2 L	2000	-	2000
FORD	LOBO	V-8, 4.6 L	2006	-	2010
FORD	EXPLORER	V-8, 4.6 L	2007	-	2010
FORD	LOBO	V-8, 5.4 L	2007	-	2010
FORD	EXPEDITION	V-8, 5.4 L	2009	-	2010
CHEVROLET	EXPRESS	V-8, 8.1 L	2002	-	2001
CHEVROLET	C y K SERIES PICKUP	V-8, 8.1 L	2002	-	2001
FORD	SUPER DUTY VAN	V-6, 4.2 L	2001	-	2001
FORD	E SERIES VAN	V-6, 4.2 L	2003	-	1997
FORD	F-150	V-6, 4.2 L	2007	-	2000
FORD	F-250	V-8, 4.6 L	2006	-	2005
FORD	F-150	V-8, 4.6 L	2008	-	2010

### K061031



LINCOLN	NAVIGATOR	V-8, 5.4 L	2008	-	2009
CHEVROLET	C y K SERIES PICKUP	V-8, 8.1 L	2002	-	2001
FORD	LOBO	V-8, 4.6 L	2007	-	2007
FORD	WINDSTAR	V-6, 3.8 L	1998	-	1996

## Aplicación por Producto

LINCOLN	MARK LT	V-8, 5.4 L	2007	-	2008
FORD	F-250	V-8, 4.6 L	2007	-	2007
SAAB	9 - 3	4 CIL, 2.3 L	2001	-	1999
SAAB	9 - 5	4 CIL, 2.3 L	2002	-	2002
FORD	F-150	V-6, 4.2 L	2007	-	1998
FORD	F SERIES PICKUP	V-6, 4.2 L	2001	-	1998
FORD	EXPEDITION	V-8, 5.4 L	2007	-	2008

### K061080

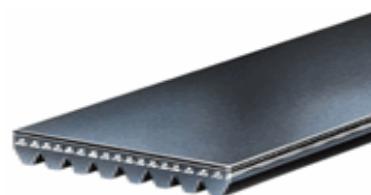

LINCOLN	LS	V-6, 3.0 L	2001	-	2001
JAGUAR	S-TYPE	V-6, 3.0 L	2005	-	2000
CHEVROLET	C y K SERIES PICKUP	V-8, 7.4 L	2000	-	1999

### K061093



CHEVROLET	MALIBU	V-6, 3.5 L	2007	-	2007
PONTIAC	G6	V-6, 3.9 L	2006	-	2006
PONTIAC	G6	V-6, 3.5 L	2008	-	2007

### K061098

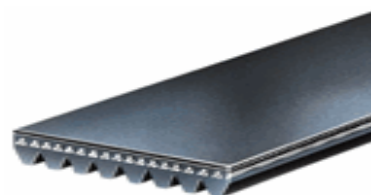

LINCOLN	LS	V-6, 3.0 L	2000	-	2000
JAGUAR	S-TYPE	V-6, 3.0 L	2001	-	2000
PONTIAC	MONTANA	V-6, 3.9 L	2008	-	2006

### K061099

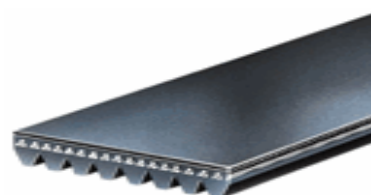

CHEVROLET	UPLANDER	V-6, 3.9 L	2007	-	2009
-----------	----------	------------	------	---	------

### K061033

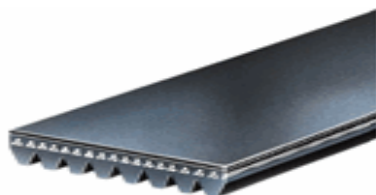

mitsubishi	LANCER	4 CIL, 2.0 L	2008	-	2008
------------	--------	--------------	------	---	------

### K061045

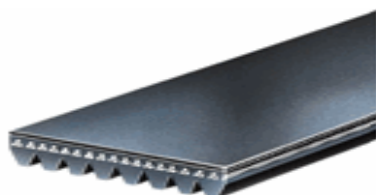

AUDI	A8	V-8, 4.2 L	2000	-	1999
AUDI	A8	V-8, 4.2 L	2006	-	2001
AUDI	A8 QUATTRO	V-8, 4.2 L	2000	-	2000

### K061058

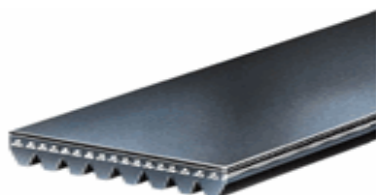

LINCOLN	LS	V-8, 3.9 L	2002	-	2000
AUDI	A8	V-8, 3.7 L	1999	-	1998
AUDI	A8 QUATTRO	V-8, 4.2 L	2004	-	1999

### K061075

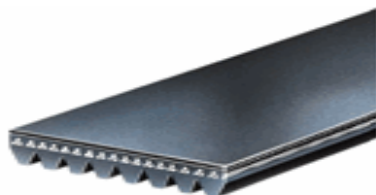

CHEVROLET	EXPRESS	V-8, 7.4 L	2000	-	1999
-----------	---------	------------	------	---	------

**K061114**

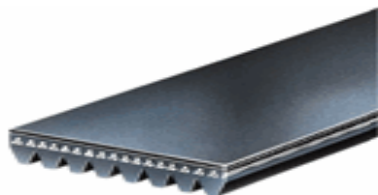

CHEVROLET	SILVERADO	V-8, 6.6 L	2001 - 2001
-----------	-----------	------------	-------------

**K061203**

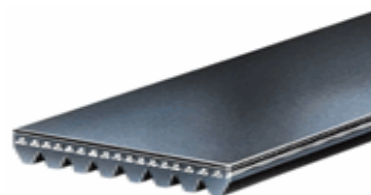

CHEVROLET	C y K SERIES PICKUP	V-8, 6.5 L	2002 - 1999
-----------	---------------------	------------	-------------

**K061123**

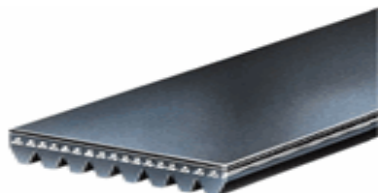

CHEVROLET	SILVERADO	V-8, 6.6 L	2001 - 2001
-----------	-----------	------------	-------------

**K069070**



FORD	F-150	V-6, 4.2 L	2000 - 2000
------	-------	------------	-------------

**K061145**

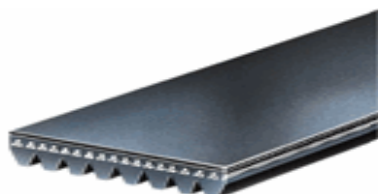

CHEVROLET	SUBURBAN	V-8, 5.7 L	1999 - 1999
CHEVROLET	C y K SERIES PICKUP	V-8, 5.7 L	1999 - 1999
CHEVROLET	C-3500	V-8, 5.7 L	1999 - 1999
CHEVROLET	CHEYENNE	V-8, 5.7 L	1999 - 1999
CHEVROLET	C-2500	V-8, 5.7 L	1999 - 1999
CHEVROLET	C-1500	V-8, 5.7 L	1999 - 1999
CHEVROLET	400SS	V-8, 5.7 L	1999 - 1999

**K070425**



FIAT	DUCATO	4 CIL. 2.3 L DIESE	2008 - 2010
------	--------	--------------------	-------------

**K070443**

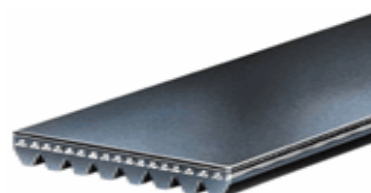

RENAULT	MEGANE	4 CIL, 2.0 L	2004 - 2009
RENAULT	SCENIC	4 CIL, 2.0 L	2004 - 2009

**K061187**

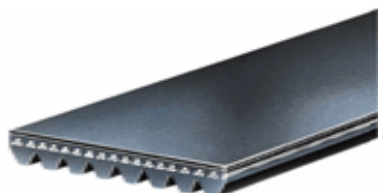

HUMMER	H1	V-8, 6.6 L	2007 - 2006
--------	----	------------	-------------

**K070539**

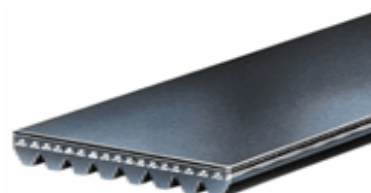

BMW	X5	V-6, 3.0 L	2007 - 2008
-----	----	------------	-------------

### K070610

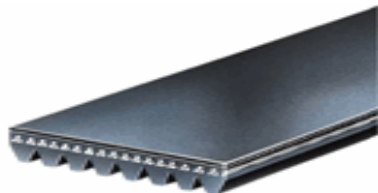

TOYOTA	HIGHLANDER	V-6, 3.5 L	2008	-	2010
TOYOTA	RAV 4	V-6, 3.5 L	2006	-	2010
TOYOTA	SIENNA	V-6, 3.5 L	2011	-	2011

### K070669

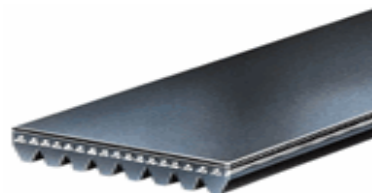

NISSAN	MURANO	V-6, 3.5 L	2010	-	2010
NISSAN	MAXIMA	V-6, 3.5 L	2009	-	2009
NISSAN	ALTIMA	V-6, 3.5 L	2009	-	2009

### K070622

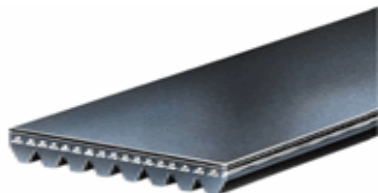

BMW	530i	6 CIL, 3.0 L	2002	-	2002
-----	------	--------------	------	---	------

### K070673

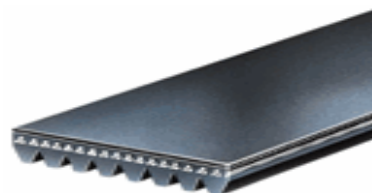

NISSAN	ALTIMA	V-6, 3.5 L	2008	-	2007
NISSAN	MURANO	V-6, 3.5 L	2009	-	2009

### K070640

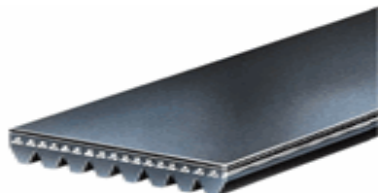

BMW	740iL	V-8, 4.4 L	2001	-	1998
BMW	540i	V-8, 4.4 L	2001	-	1998
BMW	X5	V-8, 4.4 L	2000	-	2000
BMW	740i	V-8, 4.4 L	2001	-	1998
BMW	M5	V-8, 5.0 L	2003	-	2000

### K070680

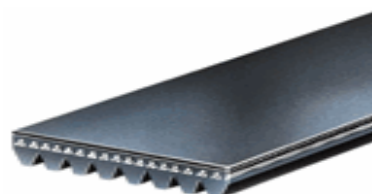

ACURA	RDX	4 CIL, 2.3 L	2006	-	2010
-------	-----	--------------	------	---	------

### K070644

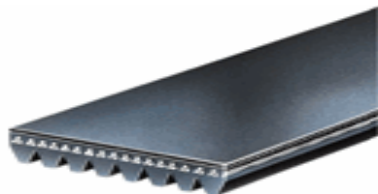

LAND ROVER	RANGE ROVER	V-8, 4.4 L	2003	-	2005
------------	-------------	------------	------	---	------

### K070683

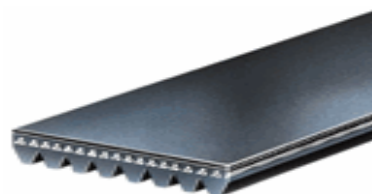

HONDA	CR-V	4 CIL, 2.0 L	2003	-	2002
HONDA	CR-V	4 CIL, 2.4 L	2004	-	2004
HONDA	CR-V	4 CIL, 2.4 L	2006	-	2005

## Aplicación por Producto

### K070690

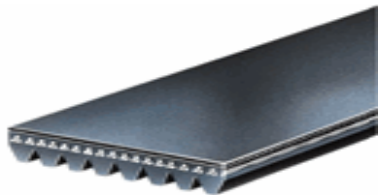

TOYOTA	HIACE	4 CIL, 2.7 L	2008	-	2010
--------	-------	--------------	------	---	------

### K070750

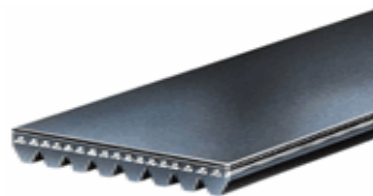

HONDA	CR-V	4 CIL, 2.4 L	2007	-	2009
-------	------	--------------	------	---	------

TOYOTA	MATRIX	4 CIL, 2.4 L	2009	-	2010
--------	--------	--------------	------	---	------

TOYOTA	CAMRY	4 CIL, 2.4 L	2008	-	2009
--------	-------	--------------	------	---	------

TOYOTA	COROLLA	4 CIL, 2.4 L	2009	-	2010
--------	---------	--------------	------	---	------

TOYOTA	RAV 4	4 CIL, 2.4 L	2006	-	2008
--------	-------	--------------	------	---	------

### K070694

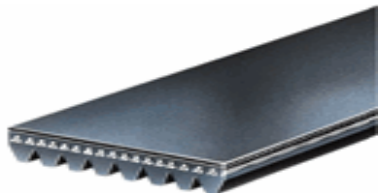

### K070763

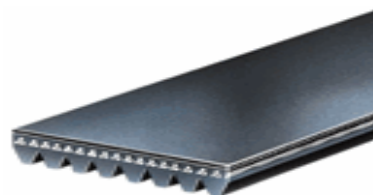

ACURA	TSX	4 CIL, 2.4 L	2009	-	2010
-------	-----	--------------	------	---	------

NISSAN	URVAN	4 CIL, 3.0 L DIESE	2009	-	2010
--------	-------	--------------------	------	---	------

### K070701

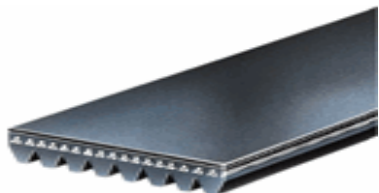

TOYOTA	RAV 4	4 CIL, 2.4 L	2005	-	2005
--------	-------	--------------	------	---	------

TOYOTA	RAV 4	4 CIL, 2.4 L	2006	-	2003
--------	-------	--------------	------	---	------

TOYOTA	CAMRY	4 CIL, 2.4 L	2006	-	2003
--------	-------	--------------	------	---	------

TOYOTA	CAMRY	4 CIL, 2.4 L	2005	-	2005
--------	-------	--------------	------	---	------

TOYOTA	RAV 4	4 CIL, 2.0 L	2003	-	2003
--------	-------	--------------	------	---	------

HONDA	ACCORD	4 CIL, 2.4 L	2007	-	2003
-------	--------	--------------	------	---	------

HONDA	ACCORD	4 CIL, 2.4 L	2004	-	2004
-------	--------	--------------	------	---	------

### K070776

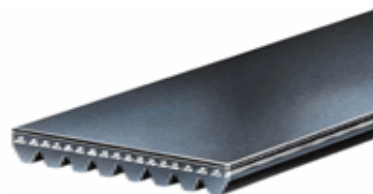

### K070721

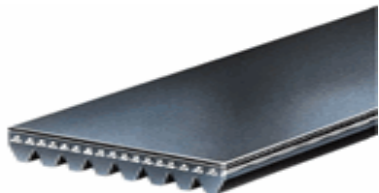

DODGE	VIPER	V-10, 8.0 L	2002	-	1998
-------	-------	-------------	------	---	------

HONDA	ACCORD	4 CIL, 2.4 L	2008	-	2010
-------	--------	--------------	------	---	------

### K070795

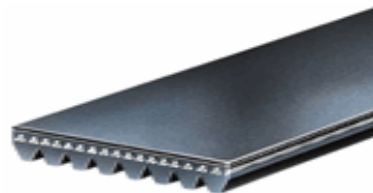

### K070735

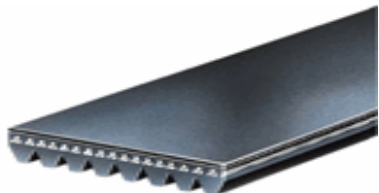

NISSAN	370Z	V-6, 3.7 L	2009	-	2009
--------	------	------------	------	---	------



### K070810

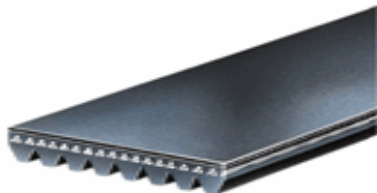

NISSAN	350Z	V-6, 3.5 L	2007 - 2009
--------	------	------------	-------------

### K070855

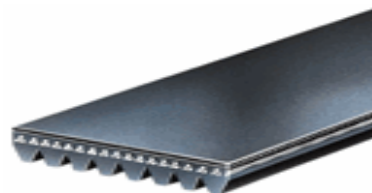

HONDA	CIVIC	4 CIL, 1.8 L	2007 - 2010
-------	-------	--------------	-------------

### K070822

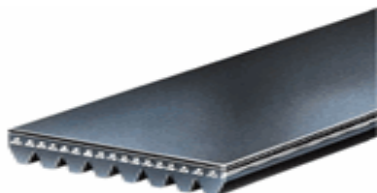

TOYOTA	CAMRY	V-6, 3.5 L	2009 - 2011
TOYOTA	SIENNA	V-6, 3.5 L	2009 - 2010

### K070873

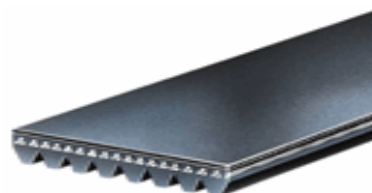

NISSAN	XTERRA	V-6, 4.0 L	2007 - 2005
NISSAN	FRONTIER	V6, 4.0 L	2008 - 2008
NISSAN	PATHFINDER	V-6, 4.0 L	2007 - 2010
NISSAN	FRONTIER	V-6, 4.0 L	2007 - 2005

### K070825

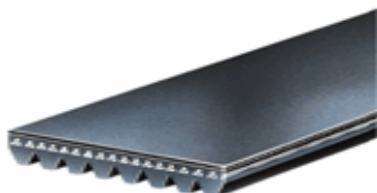

TOYOTA	CAMRY	V-6, 3.5 L	2008 - 2007
TOYOTA	SIENNA	V-6, 3.5 L	2008 - 2007

### K070880

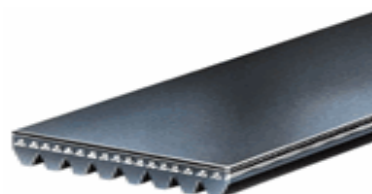

DODGE	RAM 1500	V-6, 3.9 L	2000 - 1997
DODGE	RAM SERIES PICKUP	V-6, 3.9 L	2001 - 1997
DODGE	RAM 4000	V-8, 5.9 L	2001 - 1997
DODGE	DURANGO	V-8, 5.2 L	2000 - 1999
DODGE	DURANGO	V-6, 3.9 L	1999 - 1998
DODGE	RAM SERIES PICKUP	V-8, 5.2 L	2001 - 1997
DODGE	RAM SERIES PICKUP	V-8, 5.9 L	2001 - 1996
DODGE	RAM CHARGER	V-8, 5.9 L	2000 - 1999
DODGE	RAM 2500	V-8, 5.2 L	2000 - 1997
DODGE	DURANGO	V-8, 5.2 L	1998 - 1998
DODGE	DURANGO	V-8, 5.9 L	2000 - 1998
DODGE	RAM 3500	V-8, 5.9 L	2001 - 1996
DODGE	RAM 2500	V-8, 5.9 L	2000 - 1997

### K070834

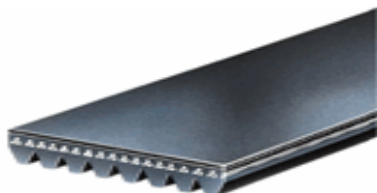

TOYOTA	FJ CRUISER	V-6, 4.0 L	2008 - 2007
TOYOTA	TACOMA	V-6, 4.0 L	2008 - 2010
NISSAN	URVAN	4 CIL, 2.5 L	2009 - 2010

### K070882

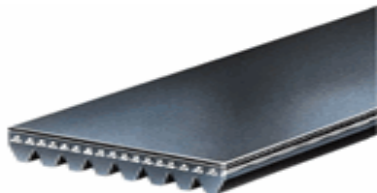

LAND ROVER	DISCOVERY	V-8, 4.0 L	1999	-	1999
------------	-----------	------------	------	---	------

### K070916

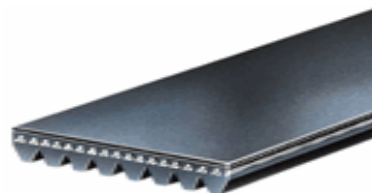

LAND ROVER	RANGE ROVER	V-8, 4.0 L	2000	-	1999
LAND ROVER	RANGE ROVER	V-8, 4.6 L	2002	-	1999

### K070890

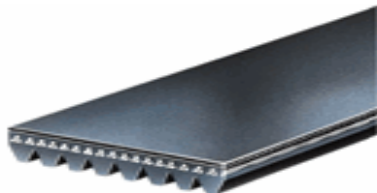

JEEP	GRAND CHEROKEE	V-8, 5.9 L	1998	-	1998
JEEP	GRAND CHEROKEE	V-8, 5.2 L	1998	-	1996

### K070922

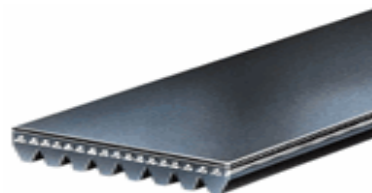

LAND ROVER	DISCOVERY	V-8, 4.0 L	2000	-	2004
LAND ROVER	DISCOVERY SERIES II	V-8, 4.0 L	2001	-	1999

### K070901

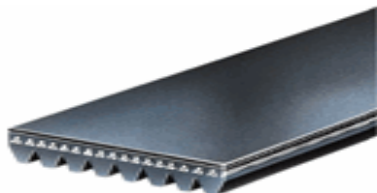

TOYOTA	HIACE	4 CIL, 2.7 L	2008	-	2010
--------	-------	--------------	------	---	------

### K070931

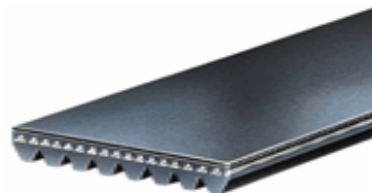

VOLKSWAGEN	TOUAREG	V-8, 4.2 L	2006	-	2005
------------	---------	------------	------	---	------

### K070903

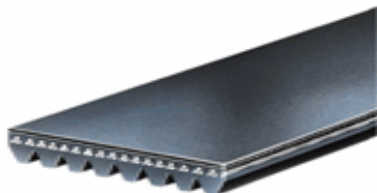

DODGE	RAM 1500	6 CIL, 3.9 L	2003	-	2003
DODGE	RAM MAXI VAN 2500	V-6, 3.9 L	2001	-	1997
DODGE	RAM MAXI WAGON 3500	V-8, 5.9 L	2002	-	1997
DODGE	RAM WAGON 2500	V-8, 5.9 L	2001	-	1997
DODGE	RAM WAGON 2500	V-8, 5.2 L	2001	-	1997
DODGE	RAM MAXI VAN 2500	V-8, 5.2 L	2002	-	1997
DODGE	RAM WAGON 3500	V-8, 5.9 L	2002	-	2002
DODGE	RAM MAXI VAN 3500	V-8, 5.9 L	2002	-	1997
DODGE	RAM WAGON 1500	V-6, 3.9 L	2001	-	1997
DODGE	RAM MAXI VAN 1500	V-6, 3.9 L	2002	-	1997

### K070951

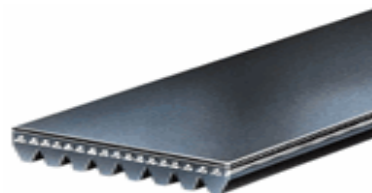

MITSUBISHI	MONTERO	V-6, 3.8 L	2007	-	2004
------------	---------	------------	------	---	------

### K070971

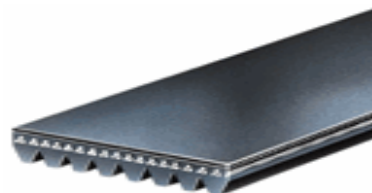

## Aplicación por Producto

NISSAN	ARMADA	V-8, 5.6 L	2006 - 2010
NISSAN	TITAN	V-8, 5.6 L	2009 - 2009

### K071013

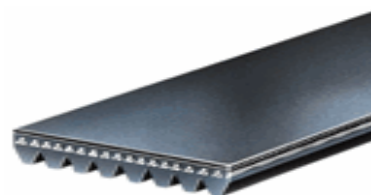

DODGE	RAM 3500	V-8, 5.7 L	2007 - 2003
DODGE	RAM 2500	V-8, 5.7 L	2008 - 2008

### K071031

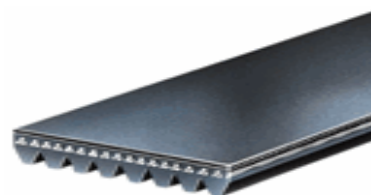

DODGE	RAM SERIES PICKUP	V-10, 8.0 L	2001 - 1999
-------	-------------------	-------------	-------------

### K071040

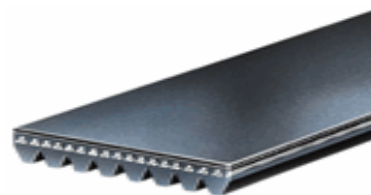

DODGE	RAM 3500	V-8, 5.9 L	2000 - 1997
DODGE	RAM 2500	V-8, 5.9 L	2000 - 1997
DODGE	RAM SERIES PICKUP	V-8, 5.2 L	2000 - 2000
DODGE	RAM CHARGER	V-8, 5.9 L	2001 - 1999

### K071065

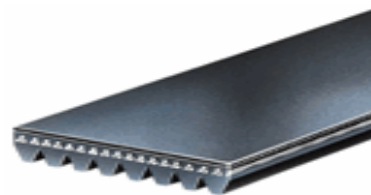

LAND ROVER	DISCOVERY	V-8, 4.0 L	2000 - 2004
------------	-----------	------------	-------------

### K070975

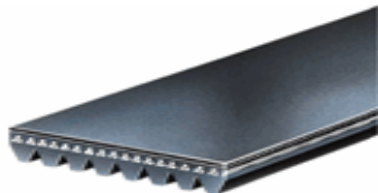

NISSAN	TITAN	V-8, 5.6 L	2008 - 2006
DODGE	DURANGO	V-6, 3.9 L	1999 - 1998
DODGE	RAM SERIES PICKUP	V-6, 3.9 L	2001 - 1997
DODGE	RAM 4000	V-8, 5.9 L	2000 - 1997
DODGE	DURANGO	V-8, 5.9 L	2003 - 1998
DODGE	DURANGO	V-8, 5.2 L	1998 - 1998
DODGE	DURANGO	V-8, 5.2 L	2000 - 1999
DODGE	RAM 4000	V-8, 5.9 L	2002 - 2002
DODGE	RAM 1500	V-6, 3.9 L	2001 - 1997

### K071005

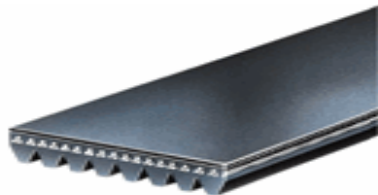

AUDI	A8 QUATTRO	V-8, 4.2 L	2005 - 2005
DODGE	RAM WAGON 3500	V-8, 5.9 L	2002 - 2000
DODGE	RAM WAGON 2500	V-8, 5.2 L	2001 - 1997
AUDI	A8	V-8, 4.2 L	2007 - 2007
DODGE	RAM MAXI VAN 1500	V-6, 3.9 L	2002 - 1997
DODGE	RAM MAXI VAN 2500	V-6, 3.9 L	2001 - 1997
DODGE	RAM WAGON 3500	V-8, 5.2 L	2001 - 2000
DODGE	RAM MAXI VAN 2500	V-8, 5.2 L	2002 - 1997

### K071009

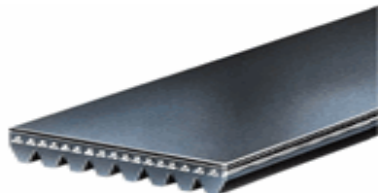

DODGE	DURANGO	V-8, 5.7 L	2005 - 2005
DODGE	DURANGO	V-8, 5.7 L	2007 - 2004
CHRYSLER	ASPEN	V-8, 5.7 L	2007 - 2009
DODGE	RAM SERIES PICKUP	V-10, 8.0 L	2001 - 2000

### K071130

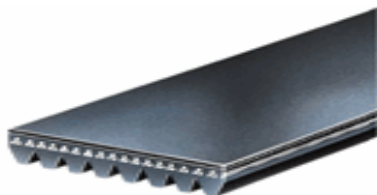

DODGE	RAM SERIES PICKUP	V-8, 5.9 L	2001	-	1997
DODGE	RAM CHARGER	V-8, 5.9 L	2001	-	1999
DODGE	RAM SERIES PICKUP	V-10, 8.0 L	2002	-	1999
DODGE	RAM 2500	V-8, 5.9 L	2000	-	1997
DODGE	RAM RUNNER	V-10, 8.0 L	2000	-	1997
DODGE	RAM 3500	V-8, 5.9 L	2000	-	1997
DODGE	RAM 4000	V-8, 5.9 L	2000	-	1997
DODGE	RAM SERIES PICKUP	V-8, 5.2 L	2000	-	2000

### K080797

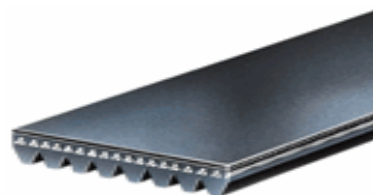

FORD	LOBO	V-8, 5.4 L	2002	-	2002
FORD	LOBO	V-8, 4.6 L	2000	-	1997
FORD	F SERIES PICKUP	V-8, 4.6 L	2001	-	1998
FORD	F-250 XLT	V-8, 4.6 L	2001	-	1998
FORD	F-250 XL	V-8, 5.4 L	1999	-	1999
FORD	F-250 XL	V-8, 4.6 L	2001	-	1998
FORD	F-250	V-8, 4.6 L	2001	-	1998
FORD	F SERIES PICKUP	V-8, 5.4 L	2002	-	1999
FORD	F SERIES PICKUP	V-6, 4.2 L	2000	-	2000

### K080653

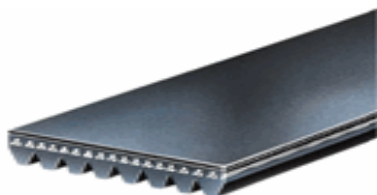

DODGE	RAM SERIES PICKUP	6 CIL, 5.9 L Diesel	2002	-	1999
-------	-------------------	---------------------	------	---	------

### K080806

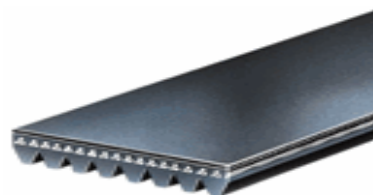

FORD	E SERIES VAN	V-8, 5.4 L	2001	-	1997
FORD	F SERIES PICKUP	V-10, 6.8 L	2000	-	1999
FORD	SUPER DUTY VAN	V-10, 6.8 L	2001	-	1999
FORD	EXCURSION	V-8, 5.4 L	2001	-	2000
FORD	EXCURSION	V-10, 6.8 L	2003	-	2000
FORD	E SERIES VAN	V-8, 4.6 L	2001	-	1999
FORD	SUPER DUTY VAN	V-8, 5.4 L	2001	-	1999
DODGE	RAM SERIES PICKUP	CUMMINS 6B5.9	1997	-	1997
FORD	F-350 SUPER DUTY	V-8, 5.4 L	2001	-	1999
FORD	F SERIES PICKUP	V-8, 4.6 L	1999	-	1999
FORD	SUPER DUTY PICKUP	V-10, 6.8 L	2000	-	1999
FORD	SUPER DUTY PICKUP	V-8, 5.4 L	2001	-	1999
FORD	F-450 SUPER DUTY	V-8, 5.4 L	2000	-	1999
FORD	F-450 SUPER DUTY	V-10, 6.8 L	2004	-	1999

### K080660

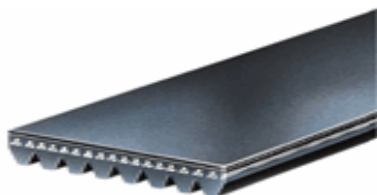

FORD	SUPER DUTY VAN	V-8, 4.6 L	2003	-	2003
FORD	LOBO	V-8, 5.4 L	2002	-	2002
FORD	F SERIES PICKUP	V-8, 5.4 L	2002	-	1999

### K080751

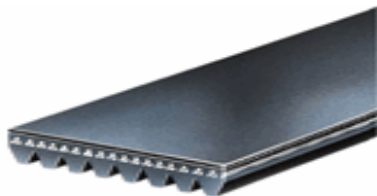

FORD	MUSTANG	V-8, 4.6 L	2004	-	2002
------	---------	------------	------	---	------

### K080810

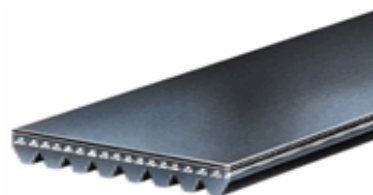

DODGE	RAM SERIES PICKUP	V-8, 5.9 L	2002	-	2002
DODGE	RAM 2500	V-8, 5.9 L	2002	-	2002

## Aplicación por Producto

DODGE	RAM 3500	V-8, 5.9 L	2002	-	2002
DODGE	RAM 4000	V-8, 5.9 L	2002	-	2002
DODGE	RAM SERIES PICKUP	6 CIL, 5.9 L Diesel	2002	-	1999

### K080981

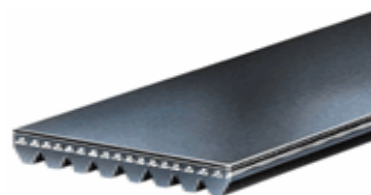

FORD	EXPEDITION	V-8, 5.4 L	2001	-	1997
FORD	EXPEDITION	V-8, 4.6 L	2001	-	1997
LINCOLN	NAVIGATOR	V-8, 5.4 L	2001	-	1998

### K080991

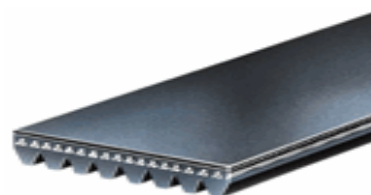

FORD	SUPER DUTY VAN	V-8, 5.4 L	2000	-	1999
FORD	F-250	V-8, 4.6 L	2001	-	1998
FORD	SUPER DUTY VAN	V-8, 4.6 L	2003	-	2003
FORD	E SERIES VAN	V-8, 5.4 L	2001	-	1997
FORD	LOBO	V-8, 4.6 L	2000	-	1997
FORD	F SERIES PICKUP	V-8, 5.4 L	2002	-	1999
FORD	F SERIES PICKUP	V-8, 4.6 L	2001	-	1998
FORD	LOBO	V-8, 5.4 L	2003	-	2002
FORD	EXCURSION	V-10, 6.8 L	2002	-	2000
FORD	F-250 XL	V-8, 4.6 L	2001	-	1998
FORD	E SERIES VAN	V-8, 4.6 L	2001	-	1999
FORD	F-250 XLT	V-8, 4.6 L	2001	-	1998
FORD	F-250 XL	V-8, 5.4 L	1999	-	1999
FORD	EXCURSION	V-8, 5.4 L	2001	-	2000
FORD	SUPER DUTY VAN	V-10, 6.8 L	2001	-	1999

### K081000

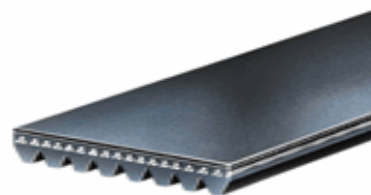

FORD	F-450 SUPER DUTY	V-8, 5.4 L	2000	-	1999
FORD	SUPER DUTY PICKUP	V-10, 6.8 L	2000	-	1999
FORD	F SERIES PICKUP	V-10, 6.8 L	2000	-	1999
FORD	SUPER DUTY PICKUP	V-8, 5.4 L	2001	-	1999
FORD	F-450 SUPER DUTY	V-10, 6.8 L	2004	-	1999
FORD	F-350 SUPER DUTY	V-8, 5.4 L	2001	-	1999

### K080865

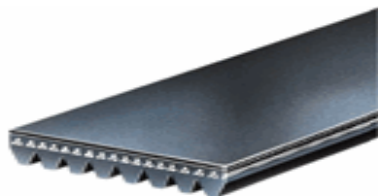

FORD	F-250 SUPER DUTY	V-8, 6.4 L DIESEL	2008	-	2010
FORD	F-450 SUPER DUTY	V-8, 6.4 L DIESEL	2008	-	2010
FORD	F-550 SUPER DUTY	V-8, 6.4 L DIESEL	2008	-	2010

### K080911

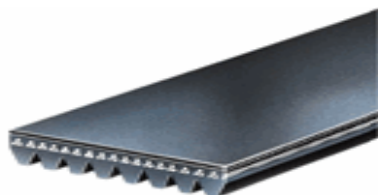

FORD	SUPER DUTY VAN	V-8, 5.4 L	2001	-	2001
------	----------------	------------	------	---	------

### K080948

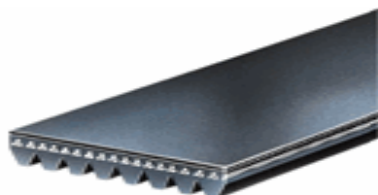

TOYOTA	LAND CRUISER	V-8, 5.7 L	2008	-	2010
TOYOTA	TUNDRA	V-8, 5.7 L	2009	-	2010
TOYOTA	SEQUOIA	V-8, 5.7 L	2009	-	2010

### K080956

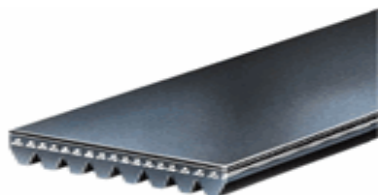

FORD	F-450 SUPER DUTY	V-8, 6.4 L DIESEL	2008	-	2010
FORD	F-550 SUPER DUTY	V-8, 6.4 L DIESEL	2008	-	2010
FORD	F-250 SUPER DUTY	V-8, 6.4 L DIESEL	2008	-	2010



### K081102

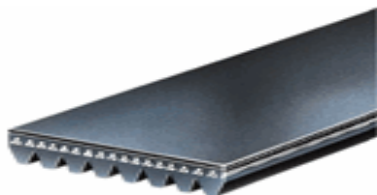

DODGE	RAM 4000	V-6, 6.7 L DIESEL	2008	-	2009
FORD	SUPER DUTY PICKUP	V-10, 6.8 L	2000	-	1999
DODGE	RAM 4000	V-6, 5.9 L DIESEL	2007	-	2008

### K081265

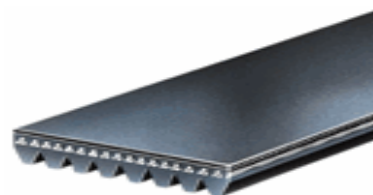

FORD	SUPER DUTY PICKUP	V-8, 6.0 L DIESEL	2003	-	2003
DODGE	RAM 4000	V-6, 5.9 L DIESEL	2007	-	2003

### K081213

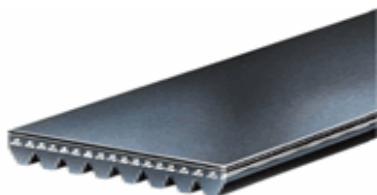

FORD	SUPER DUTY PICKUP	V-8, 7.3 L	2002	-	2002
FORD	SUPER DUTY VAN	V-8, 7.3 L	2001	-	1999

### K081359



FORD	SUPER DUTY VAN	V-8, 7.3 L	2001	-	1999
------	----------------	------------	------	---	------

### K081223

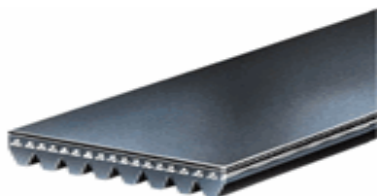

FORD	SUPER DUTY PICKUP	V-8, 7.3 L	2002	-	1999
FORD	F-450 SUPER DUTY	V-8, 7.3 L	2003	-	2001

### K081377

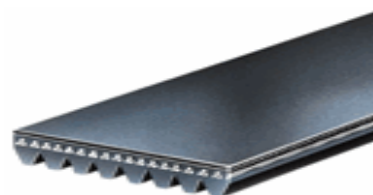

FORD	SUPER DUTY PICKUP	V-8, 7.3 L	2002	-	1999
------	-------------------	------------	------	---	------

### K081264

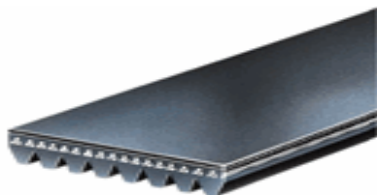

DODGE	RAM 4000	V-6, 6.7 L DIESEL	2008	-	2009
DODGE	RAM 4000	V-6, 5.9 L DIESEL	2008	-	2008

### PQ17490



NISSAN	XTERRA	4 CIL, 2.4 L	2000	-	2000
--------	--------	--------------	------	---	------

### T1013

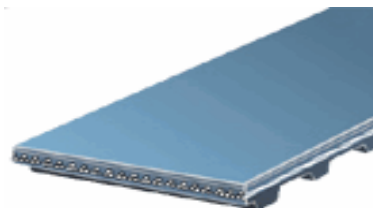

HYUNDAI	ATOS	4 CIL, 1.0 L	2004	-	2000
---------	------	--------------	------	---	------

## Aplicación por Producto

HYUNDAI	ATOS	4 CIL, 1.1 L	2008	-	2010
---------	------	--------------	------	---	------

### T1094

### T1022

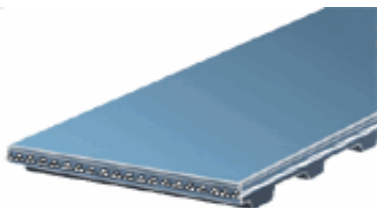

CHEVROLET	ASTRA	4 CIL, 2.0 L	2006	-	2004
CHEVROLET	ZAFIRA	4 CIL, 2.0 L	2006	-	2004

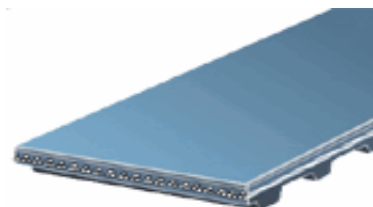

CHEVROLET	CORSA	4 CIL, 1.4 L	2003	-	2003
CHEVROLET	CORSA	4 CIL, 1.4 L	2002	-	2002
CHEVROLET	ASTRA	4 CIL, 1.8 L	2003	-	2000
CHEVROLET	ZAFIRA	4 CIL, 1.8 L	2003	-	2000

### T1050

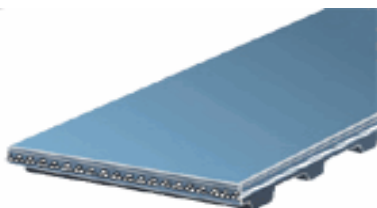

MG	TF	4 CIL, 1.8 L	2002	-	2005
MG	ZR	4 CIL, 1.8 L	2002	-	2005

### T1095

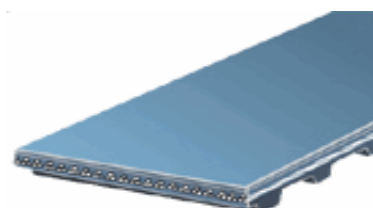

RENAULT	SANDERO	4 CIL, 1.6 L	2010	-	2010
RENAULT	CLIO	4 CIL, 1.6 L	2008	-	2009
RENAULT	MEGANE	4 CIL, 1.6 L	2008	-	2008
RENAULT	KANGOO EXPRESS	4 CIL, 1.6 L	2008	-	2009
RENAULT	STEPWAY	4 CIL, 1.6 L	2010	-	2010
RENAULT	KANGOO	4 CIL, 1.6 L	2008	-	2010
RENAULT	EUROCLIO	4 CIL, 1.6 L	2008	-	2007
NISSAN	PLATINA	4 CIL, 1.6 L	2008	-	2010
NISSAN	APRIO	4 CIL, 1.6 L	2008	-	2010

### T1083

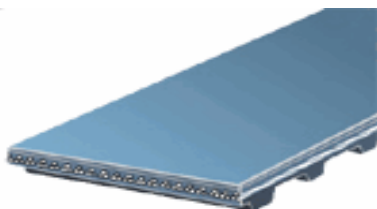

MG	ZR	4 CIL, 1.8 L	2002	-	2005
MG	TF	4 CIL, 1.8 L	2002	-	2005

### T1096

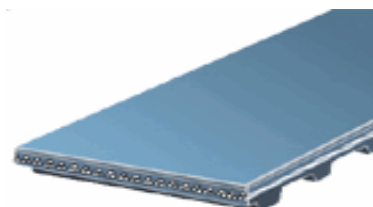

HYUNDAI	H100 VAN/WAGON	4 CIL, 2.5 L DIESE	2009	-	2010
HYUNDAI	H100	4 CIL, 2.5 L DIESE	2008	-	2010

### T1086

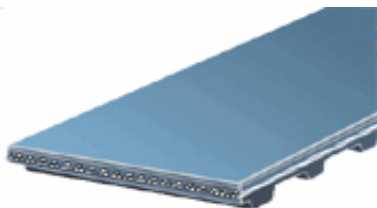

FORD	FIESTA	4 CIL, 1.4 L	2003	-	1999
------	--------	--------------	------	---	------

### T1096A

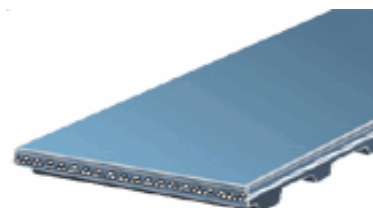

FIAT	GRANDE PUNTO	4 CIL, 1.4 L	2009	-	2010
------	--------------	--------------	------	---	------

## Aplicación por Producto

FIAT	BRAVO	4 CIL. 1.4 L	2009 - 2010
------	-------	--------------	-------------

### T1503

### T124

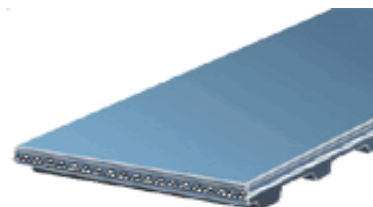
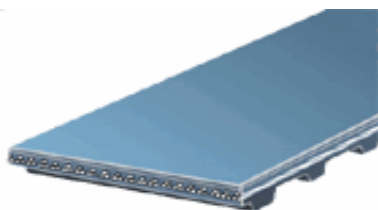

HYUNDAI	H100	4 CIL, 2.4 L	2005 - 2003
---------	------	--------------	-------------

PEUGEOT	307	4 CIL, 2.0 L	2008 - 2009
PEUGEOT	407	4 CIL, 2.2 L	2008 - 2005

### T1284

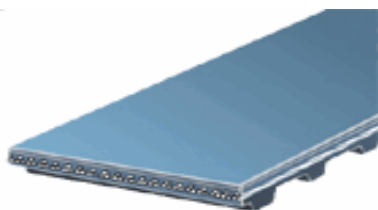

### T1504

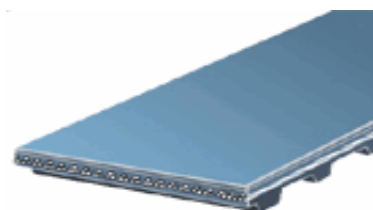

RENAULT	CLIO	4 CIL, 2.0 L SPOR	2006 - 2003
RENAULT	SCENIC	4 CIL, 2.0 L	2003 - 2001
RENAULT	MEGANE	4 CIL, 2.0 L	2003 - 2001

PEUGEOT	306	4 CIL, 2.0 L	2004 - 1999
PEUGEOT	306	4 CIL, 1.8 L	2004 - 1999
PEUGEOT	406	4 CIL, 2.0 L	2004 - 2000

### T139

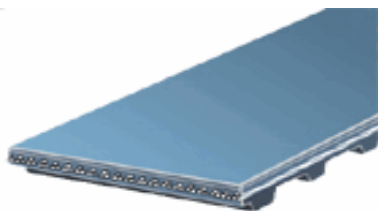

### T1548

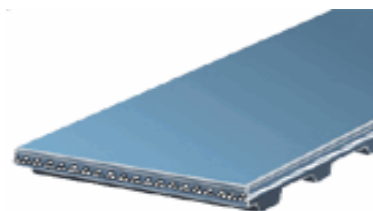

CHRYSLER	GRAND VOYAGER	V-6, 3.3 L	2000 - 2000
----------	---------------	------------	-------------

SEAT	IBIZA	4 CIL, 1.6 L	2007 - 2009
VOLKSWAGEN	SAVEIRO	4 CIL, 1.6 L	2010 - 2010
VOLKSWAGEN	LUPO	4 CIL, 1.6 L	2008 - 2004
VOLKSWAGEN	SPORTVAN	4 CIL, 1.6 L	2008 - 2006
VOLKSWAGEN	GOL	4 CIL, 1.6 L	2009 - 2010
VOLKSWAGEN	POLO	4 CIL, 1.6 L	2007 - 2003
VOLKSWAGEN	CROSSFOX	4 CIL, 1.6 L	2008 - 2006
SEAT	CORDOBA	4 CIL, 1.6 L	2007 - 2008
VOLKSWAGEN	POLO	4 CIL, 1.6 L	2005 - 2004

### T1502

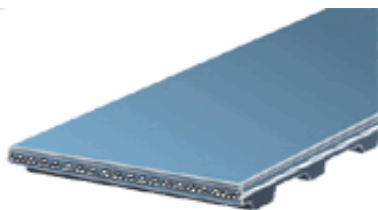

CHEVROLET	LUV	4 CIL, 2.2 L	2003 - 2001
-----------	-----	--------------	-------------

### T1558

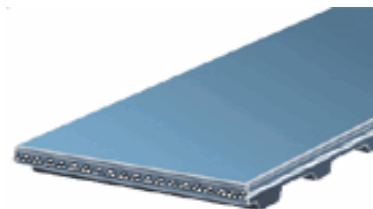

RENAULT	TRAFIC	4 CIL, 1.9 L DIESE	2008 - 2010
---------	--------	--------------------	-------------

### T1565

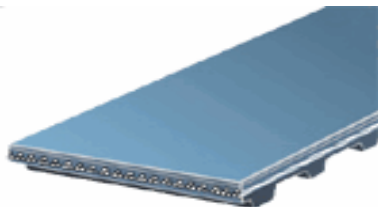

RENAULT	MEGANE	4 CIL, 2.0 L	2009 - 2009
RENAULT	MEGANE	4 CIL, 2.0 L	2008 - 2004
RENAULT	SCENIC	4 CIL, 2.0 L	2007 - 2004
RENAULT	SCENIC	4 CIL, 2.0 L	2009 - 2009

### T1596

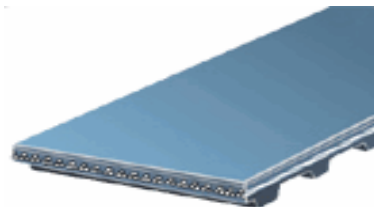

RENAULT	LAGUNA	V6, 2.4 L	2006 - 2004
PEUGEOT	407	V-6, 3.0 L	2008 - 2005
PEUGEOT	406	V-6, 3.0 L	2004 - 1999

### T1570

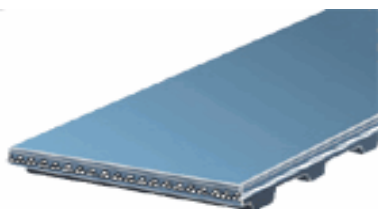

PONTIAC	MATIZ G2	4 CIL, 1.0 L	2008 - 2009
---------	----------	--------------	-------------

### T1621

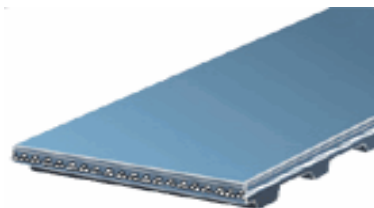

FIAT	DUCATO	4 CIL, 2.3 L DIESE	2008 - 2010
------	--------	--------------------	-------------

### T1581

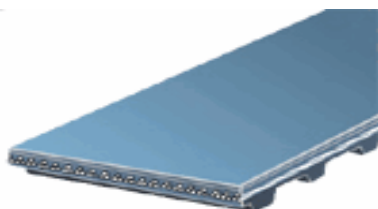

PEUGEOT	207	4 CIL, 1.6 L	2008 - 2009
PEUGEOT	206	4 CIL, 1.6 L	2008 - 1998
PEUGEOT	GRAND RAID	4 CIL, 1.6 L	2008 - 2004
PEUGEOT	PARTNER	4 CIL, 1.6 L	2008 - 2004

### T1637

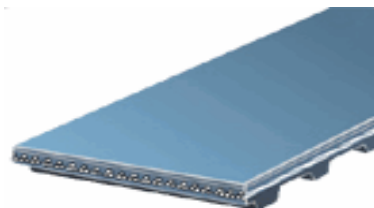

FIAT	PANDA	4 CIL, 1.2 L	2008 - 2010
------	-------	--------------	-------------

### T159

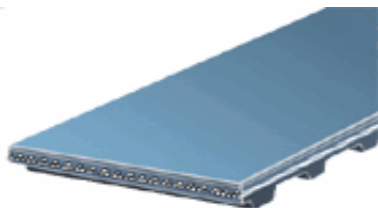

HYUNDAI	H100	4 CIL, 2.4 L	2003 - 2005
---------	------	--------------	-------------

### T167

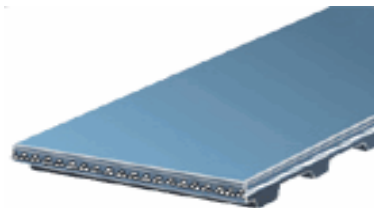

MITSUBISHI	LANCER	4 CIL, 2.0 L	2006 - 2005
------------	--------	--------------	-------------

### T168

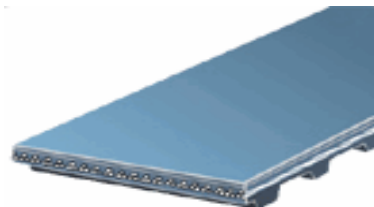

## Aplicación por Producto

MITSUBISHI	OUTLANDER	4 CIL, 2.4 L	2006 - 2004
MITSUBISHI	LANCER	4 CIL, 2.4 L	2006 - 2004
DODGE	STRATUS	4 CIL, 2.4 L	2002 - 2001
MITSUBISHI	GALANT	4 CIL, 2.4 L	2004 - 2004
MITSUBISHI	GALANT	4 CIL, 2.4 L	2007 - 2005
MITSUBISHI	LANCER	4 CIL, 2.0 L	2006 - 2005
MITSUBISHI	GRANDIS	4 CIL, 2.4 L	2008 - 2007

FIAT	PALIO ADVENTURE	4 CIL, 1.8 L	2008 - 2006
CHEVROLET	TORNADO	4 CIL, 1.8 L	2008 - 2009
CHEVROLET	CHEVY C2	4 CIL, 1.6 L	2008 - 2004
FIAT	PALIO	4 CIL, 1.8 L	2008 - 2006
CHEVROLET	MERIVA	4 CIL, 1.8 L	2007 - 2006
CHEVROLET	CHEVY	4 CIL, 1.6 L	2009 - 2010
CHEVROLET	CHEVY C2 SEDAN	4 CIL, 1.6 L	2008 - 2004

**T184**

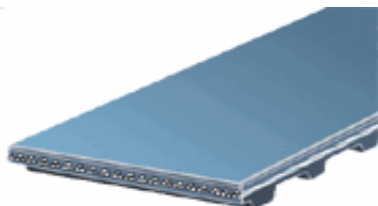

**T207**

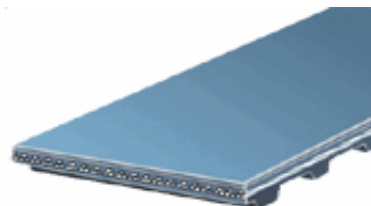

HONDA	CR-V	4 CIL, 2.0 L	2001 - 1999
-------	------	--------------	-------------

AUDI	A8 QUATTRO	V-8, 4.2 L	1999 - 1999
AUDI	A8	V-8, 4.2 L	1999 - 1999
AUDI	A8	V-8, 3.7 L	1999 - 1998

**T186**

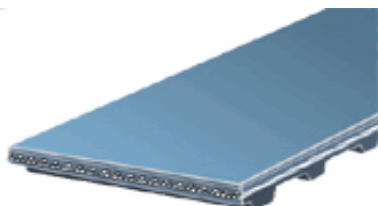

**T212**

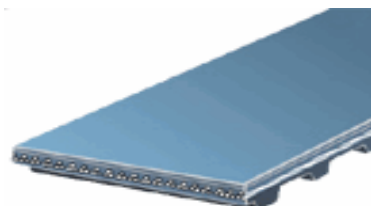

HONDA	ACCORD	4 CIL, 2.3 L	2002 - 1999
-------	--------	--------------	-------------

CHEVROLET	TRACKER	4 CIL, 1.6 L	2000 - 1997
-----------	---------	--------------	-------------

**T201**

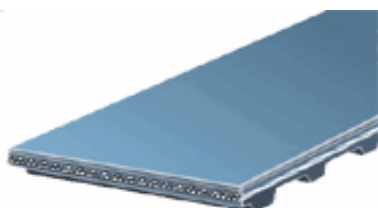

**T224**

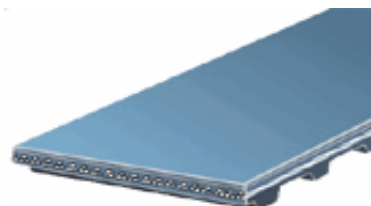

MITSUBISHI	LANCER	4 CIL, 2.0 L	2006 - 2008
MITSUBISHI	LANCER	4 CIL, 2.0 L	2004 - 2004

HONDA	CIVIC	4 CIL, 1.6 L	2000 - 1997
-------	-------	--------------	-------------

**T203**

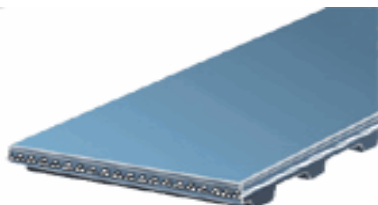

**T232**

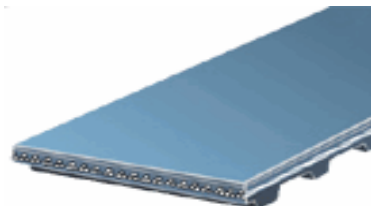

CHEVROLET	CHEVY PICK-UP	4 CIL, 1.6 L	2006 - 2002
CHEVROLET	MERIVA	4 CIL, 1.8 L	2008 - 2008
CHEVROLET	CORSA	4 CIL, 1.8 L	2008 - 2009
CHEVROLET	TORNADO	4 CIL, 1.8 L	2007 - 2003

DODGE	STRATUS	4 CIL, 2.4 L	2002 - 2001
CHRYSLER	SEBRING	4 CIL, 2.4 L	2006 - 2004



## Aplicación por Producto

### T244

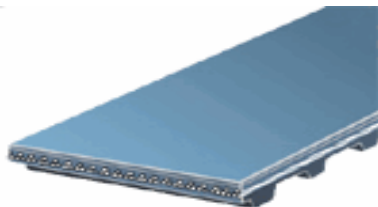

VOLVO	C70	5 CIL, 2.3 L	2001 - 2000
VOLVO	V70	5 CIL, 2.4 L	2001 - 2000

### T254

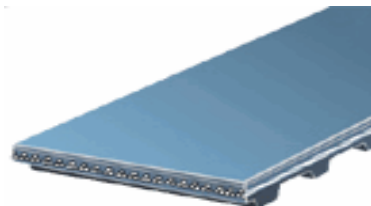

HONDA	ACCORD	4 CIL, 2.3 L	2002 - 1998
-------	--------	--------------	-------------

DODGE	NEON	4 CIL, 2.0 L	2005 - 2005
-------	------	--------------	-------------

### T245

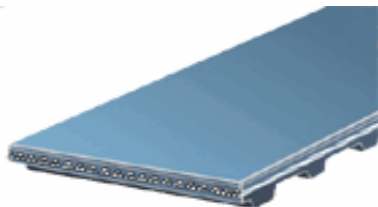

### T257

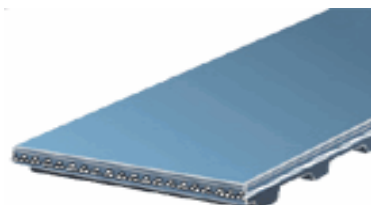

CHRYSLER	CIRRUS	4 CIL, 2.0 L	2000 - 2000
----------	--------	--------------	-------------

TOYOTA	SIENNA	V-6, 3.3 L	2006 - 2004
TOYOTA	SIENNA	V-6, 3.3 L	2005 - 2005
TOYOTA	SIENNA	V-6, 3.0 L	2003 - 2003
TOYOTA	SOLARA	V-6, 3.3 L	2006 - 2005
TOYOTA	CAMRY	V-6, 3.0 L	2005 - 2005
TOYOTA	CAMRY	V-6, 3.0 L	2006 - 2002

### T249

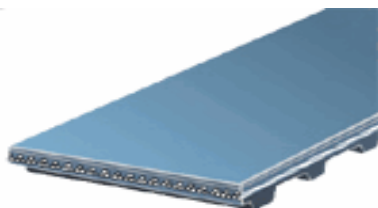

### T259

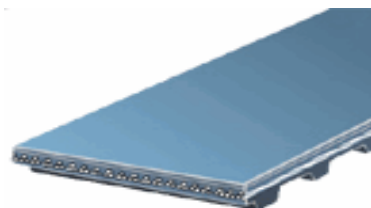

NISSAN	PATHFINDER	V-6, 3.3 L	2000 - 1998
NISSAN	QUEST	6 CIL, 3.3 L	2002 - 2002
NISSAN	XTERRA	V-6, 3.3 L	2002 - 2000
NISSAN	QUEST	V-6, 3.0 L	1998 - 1997
NISSAN	FRONTIER	V-6, 3.3 L	2004 - 1999
NISSAN	QUEST	V-6, 3.3 L	2001 - 1998

NISSAN	QUEST	V-6, 3.3 L	2001 - 1998
NISSAN	QUEST	V-6, 3.3 L	2001 - 1998
NISSAN	QUEST	V-6, 3.3 L	2001 - 1998
NISSAN	QUEST	V-6, 3.3 L	2001 - 1998
NISSAN	QUEST	V-6, 3.3 L	2001 - 1998
NISSAN	QUEST	V-6, 3.3 L	2001 - 1998

### T252

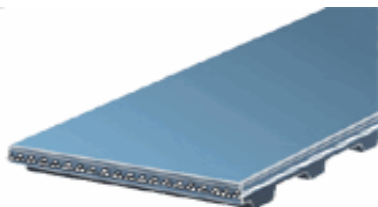

NISSAN	QUEST	V-6, 3.3 L	2001 - 1998
NISSAN	QUEST	V-6, 3.3 L	2001 - 1998
NISSAN	QUEST	V-6, 3.3 L	2001 - 1998
NISSAN	QUEST	V-6, 3.3 L	2001 - 1998
NISSAN	QUEST	V-6, 3.3 L	2001 - 1998
NISSAN	QUEST	V-6, 3.3 L	2001 - 1998

### T260

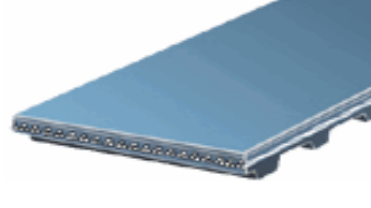

VOLVO	V70	5 CIL, 2.3 L	2001 - 2000
VOLVO	S70	5 CIL, 2.3 L	2000 - 2000
VOLVO	S60	5 CIL, 2.4 L	2001 - 2001
VOLVO	S60	5 CIL, 2.3 L	2001 - 2001
VOLVO	S40	4 CIL, 1.9 L	2001 - 2000
VOLVO	S70	5 CIL, 2.4 L	2000 - 2000
VOLVO	V40	4 CIL, 1.9 L	2001 - 2000
VOLVO	C70	5 CIL, 2.4 L	2001 - 2000

## Aplicación por Producto

VOLKSWAGEN	VW VAN	4 CIL, 1.8 L	2005	-	2005
VOLKSWAGEN	POINTER PICK-UP	4 CIL, 1.8 L	2005	-	1998
VOLKSWAGEN	VW VAN	4 CIL, 1.8 L	2006	-	2006
VOLKSWAGEN	POINTER STATION WAGON	4 CIL, 1.8 L	2001	-	1998
VOLKSWAGEN	POINTER	4 CIL, 2.0 L	2005	-	2006
VOLKSWAGEN	POINTER	4 CIL, 1.8 L	2008	-	1998
VOLKSWAGEN	POINTER	4 CIL, 1.8 L	2005	-	2005
VOLKSWAGEN	DERBY	4 CIL, 1.8 L	2008	-	2006
VOLKSWAGEN	DERBY	4 CIL, 1.8 L	2005	-	2005

### T270

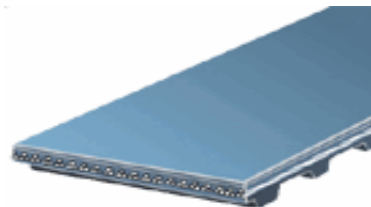

VOLVO	S80	6 CIL, 2.9 L	2001	-	1999
VOLVO	S80	6 CIL, 2.8 L	2001	-	1999

### T271

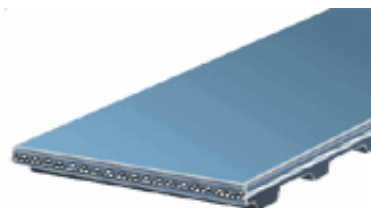

TOYOTA	4 RUNNER	V-6, 3.4 L	2002	-	2002
--------	----------	------------	------	---	------

### T273

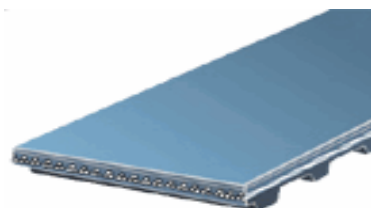

CHEVROLET	LUMINA	V-6, 3.4 L	1996	-	1996
-----------	--------	------------	------	---	------

### T276

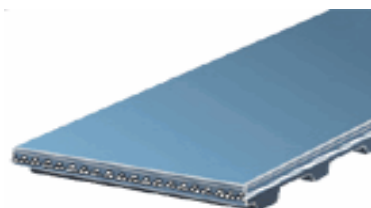

FORD	RANGER F-100	4 CIL, 2.3 L	1997	-	1996
FORD	RANGER	4 CIL, 2.3 L	2002	-	1996
FORD	RANGER	4 CIL, 2.5 L	2001	-	1999
FORD	RANGER F-100	4 CIL, 2.5 L	2000	-	1998

### T262

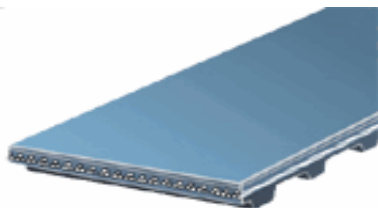

VOLKSWAGEN	CARAVELLE	4 CIL, 1.8 L	1996	-	1996
VOLKSWAGEN	DERBY	4 CIL, 2.0 L	2004	-	2003
VOLKSWAGEN	GTI	4 CIL, 2.0 L	2000	-	1999
VOLKSWAGEN	BEETLE	4 CIL, 2.0 L	2000	-	2000

### T265

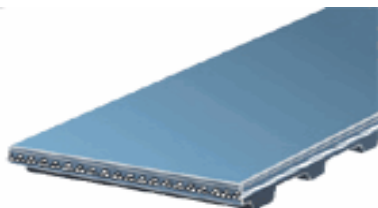

CHRYSLER	PT CRUISER	4 CIL, 2.4 L	2007	-	2010
CHRYSLER	SEBRING	4 CIL, 2.4 L	2006	-	2005
CHRYSLER	CIRRUS	4 CIL, 2.4 L	2005	-	2005
JEEP	WRANGLER	4 CIL, 2.4 L	2006	-	2003
CHRYSLER	PT CRUISER	4 CIL, 2.4 L	2005	-	2005
DODGE	NEON	4 CIL, 2.4 L	2005	-	2005
DODGE	STRATUS	4 CIL, 2.0 L	2006	-	2005
DODGE	NEON	4 CIL, 2.4 L	2006	-	2004

### T269

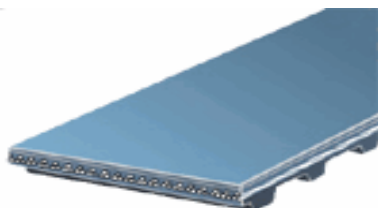

VOLVO	V70	5 CIL, 2.3 L	2000	-	2000
VOLVO	C70 T5	5 CIL, 2.3 L	2000	-	2000

### T282

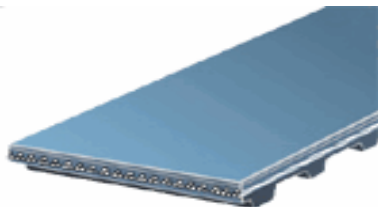

HYUNDAI	ATTITUDE	4 CIL, 1,4 L	2008 - 2010
HYUNDAI	ATTITUDE	4 CIL, 1,6 L	2008 - 2010
HYUNDAI	VERNA	4 CIL, 1,6 L	2006 - 2005
HYUNDAI	ATTITUDE	4 CIL, 1,6 L	2007 - 2006

### T287

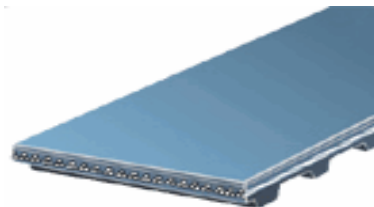

MITSUBISHI	ENDEAVOR	V-6, 3,8 L	2007 - 2005
MITSUBISHI	ENDEAVOR	V-6, 3,8 L	2004 - 2004
MITSUBISHI	ECLIPSE	V-6, 3,8 L	2007 - 2008
MITSUBISHI	GALANT	V-6, 3,8 L	2007 - 2005
MITSUBISHI	GALANT	V-6, 3,8 L	2004 - 2004

### T283

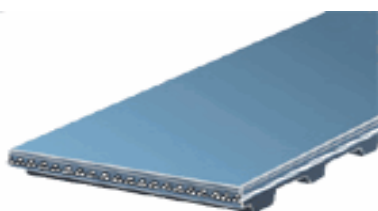

FORD	ESCORT	4 CIL, 2,0 L	2002 - 1997
FORD	FOCUS	4 CIL, 2,0 L	2003 - 2000

### T290

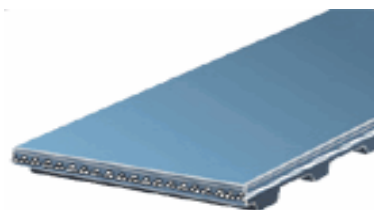

PORSCHE	911	6 CIL, 3,6 L	1998 - 1998
---------	-----	--------------	-------------

### T285

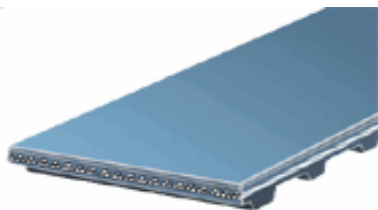

CADILLAC	CATERA	V-6, 3,0 L	2001 - 1998
SAAB	9 - 5	V-6, 3,0 L	2003 - 2002
CADILLAC	CTS	V-6, 3,2 L	2003 - 2003
CHEVROLET	VECTRA	V-6, 3,2 L	2006 - 2003

### T291

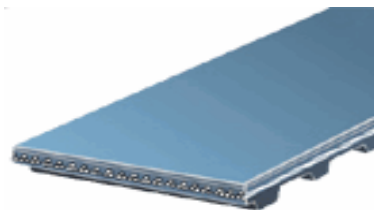

152 DIENTES

VOLKSWAGEN	PASSAT	4 CIL, 1,8 L	2003 - 2002
AUDI	A4	4 CIL, 1,8 L	2001 - 1998
VOLKSWAGEN	PASSAT	4 CIL, 1,8 L	2001 - 1999

### T286

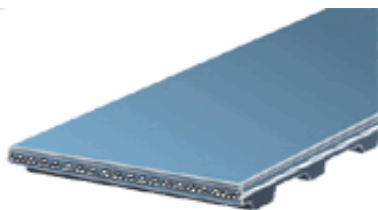

HONDA	ACCORD	V-6, 3,0 L	2002 - 1998
HONDA	PILOT	V-6, 3,5 L	2004 - 2003
HONDA	ODYSSEY	V-6, 3,5 L	2004 - 1999

### T294

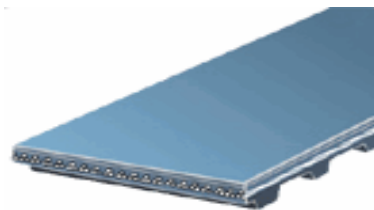

FORD	ESCAPE	4 CIL, 2,0 L	2002 - 2001
FORD	CONTOUR	4 CIL, 2,0 L	2000 - 1998
FORD	ZX2	4 CIL, 2,0 L	2002 - 2001
FORD	FOCUS	4 CIL, 2,0 L	2006 - 2000
FORD	FOCUS	4 CIL, 2,0 L	2005 - 2005
FORD	ESCORT	4 CIL, 2,0 L	2002 - 1998
MERCURY	MYSTIQUE	4 CIL, 2,0 L	2000 - 1998

## Aplicación por Producto

### T295

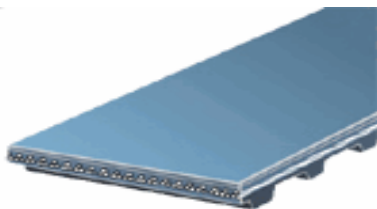

DODGE	NITRO	V-6, 4.0 L	2008 - 2010
DODGE	CHARGER	V-6, 3.5 L	2009 - 2009
DODGE	INTREPID	V-6, 3.2 L	2001 - 1999
DODGE	INTREPID	V-6, 3.5 L	2002 - 2000
CHRYSLER	300 C	V-6, 3.5 L	2006 - 2009
CHRYSLER	TOWN & COUNTRY	V6, 4.0 L	2008 - 2010
CHRYSLER	PACIFICA	V-6, 4.0 L	2008 - 2007
CHRYSLER	300 C	V-8, 6.1 L	2006 - 2005
DODGE	JOURNEY	V-6, 3.5 L	2009 - 2010
CHRYSLER	CONCORDE	V-6, 3.2 L	2001 - 1998
CHRYSLER	300 C	V-8, 5.7 L	2006 - 2005
CHRYSLER	300M	V-6, 3.5 L	2004 - 1999
CHRYSLER	CONCORDE	V-6, 3.5 L	2002 - 2002
CHRYSLER	PACIFICA	V-6, 3.5 L	2006 - 2004

### T296

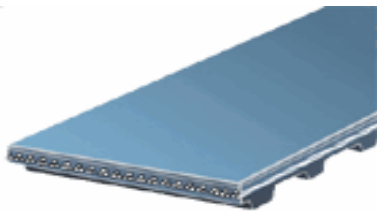

VOLKSWAGEN	BEETLE	4 CIL, 2.0 L	2006 - 1999
VOLKSWAGEN	GOLF	4 CIL, 1.8 L	2003 - 2003
SEAT	IBIZA	4 CIL, 2.0 L	2003 - 2009
VOLKSWAGEN	GOLF	4 CIL, 2.0 L	2006 - 1999
VOLKSWAGEN	GTI	4 CIL, 2.0 L	2000 - 1999
SEAT	CORDOBA	4 CIL, 2.0 L	2003 - 2007
VOLKSWAGEN	JETTA	4 CIL, 2.0 L	2008 - 2010
VOLKSWAGEN	BEETLE	4 CIL, 2.0 L	2005 - 2005
VOLKSWAGEN	POLO	4 CIL, 2.0 L	2005 - 2005
VOLKSWAGEN	POLO	4 CIL, 2.0 L	2004 - 2003

### T297

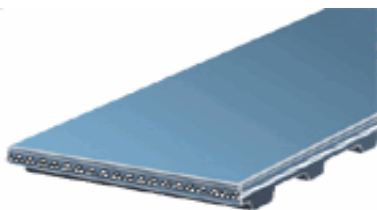

VOLKSWAGEN	PASSAT	V-6, 2.8 L	2004 - 1998
VOLKSWAGEN	GOLF	V-6, 2.8 L	2000 - 1998
VOLKSWAGEN	PASSAT	V-6, 2.8 L	2005 - 2005
AUDI	A8 QUATTRO	V-8, 4.2 L	2005 - 2000
AUDI	A4	V-6, 2.8 L	2000 - 1998
AUDI	A6	V-6, 2.7 L	2000 - 2000
AUDI	S4 QUATTRO	V-6, 2.7 L	2000 - 2000
AUDI	A6	V-6, 2.8 L	2001 - 1998
VOLKSWAGEN	TOUAREG	V-8, 4.2 L	2006 - 2005
AUDI	S4 QUATTRO	V-6, 2.7 L	2002 - 2001
AUDI	A8	V-8, 4.2 L	2006 - 2001
AUDI	A8	V-8, 4.2 L	2007 - 2000
AUDI	ALLROAD QUATTRO	V-6, 2.7 L	2006 - 2002

### T298

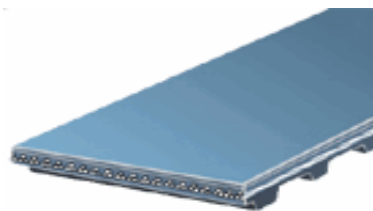

TOYOTA	SEQUOIA	V-8, 4.7 L	2008 - 2007
TOYOTA	4 RUNNER	V-8, 4.7 L	2007 - 2003
TOYOTA	TUNDRA	V-8, 4.7 L	2008 - 2007
TOYOTA	LAND CRUISER	V-8, 4.7 L	2007 - 2003
TOYOTA	4 RUNNER	V-8, 4.7 L	2005 - 2005
TOYOTA	LAND CRUISER	V-8, 4.7 L	2005 - 2005

### T304

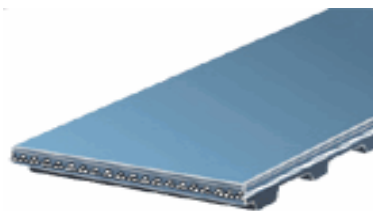

SUBARU	IMPREZA	4 CIL, 2.5 L	2007 - 2006
SUBARU	FORESTER	4 CIL, 2.5 L	2007 - 2006

### T305

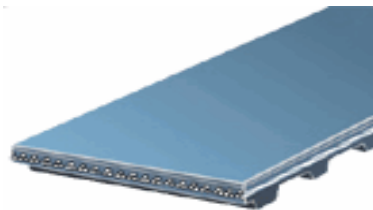

CHEVROLET	ASTRA	4 CIL, 2.4 L	2006 - 2004
CHEVROLET	ZAFIRA	4 CIL, 2.4 L	2006 - 2004

### T306

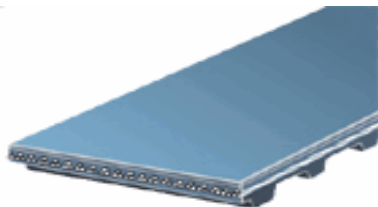

VOLKSWAGEN	JETTA	4 CIL, 2.0 L	2005	-	2005
VOLKSWAGEN	BEETLE	4 CIL, 1.8 L	2005	-	2005
VOLKSWAGEN	BEETLE	4 CIL, 1.8 L	2004	-	1999
VOLKSWAGEN	GOLF	4 CIL, 1.8 L	2005	-	2005
VOLKSWAGEN	GOLF	4 CIL, 1.8 L	2006	-	2000
VOLKSWAGEN	JETTA	4 CIL, 1.8 L	2006	-	2001
VOLKSWAGEN	PASSAT	4 CIL, 1.8 L	2005	-	2005
VOLKSWAGEN	PASSAT	4 CIL, 1.8 L	2004	-	2004
AUDI	TT	4 CIL, 1.8 L	2006	-	2000
VOLKSWAGEN	SHARAN	4 CIL, 1.8 L	2007	-	2003
AUDI	TT	4 CIL, 1.8 L	2001	-	2001
AUDI	A4	4 CIL, 1.8 L	2004	-	2006
VOLKSWAGEN	JETTA	4 CIL, 1.8 L	2005	-	2005
SEAT	LEON	4 CIL, 1.8 L	2005	-	2003
SEAT	AHLAMBRA	4 CIL, 1.8 L	2007	-	2003
SEAT	TOLEDO	4 CIL, 1.8 L	2005	-	2003

### T307

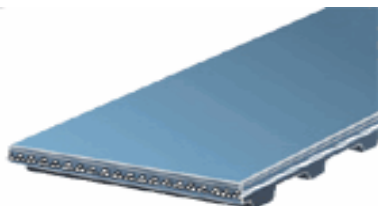

SUBARU	OUTBACK	4 CIL, 2.5 L	2007	-	2006
SUBARU	LEGACY	4 CIL, 2.5 L	2007	-	2006

### T309

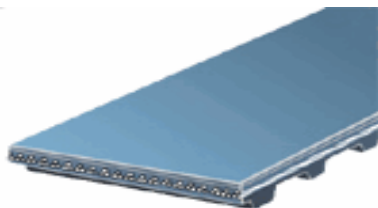

CHEVROLET	OPTRA	4 CIL, 2.0 L	2008	-	2006
CHEVROLET	OPTRA	4 CIL, 2.0 L	2009	-	2010

### T311

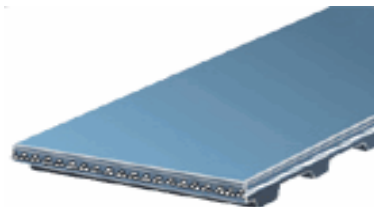

VOLVO	V40	4 CIL, 1.9 L	2001	-	2000
VOLVO	C70	5 CIL, 2.3 L	2001	-	1999
VOLVO	V70	5 CIL, 2.3 L	2001	-	1999
VOLVO	S70	5 CIL, 2.4 L	2000	-	1999
VOLVO	C70	5 CIL, 2.4 L	2001	-	1999
VOLVO	S70	5 CIL, 2.3 L	2000	-	1999
VOLVO	S60	5 CIL, 2.4 L	2001	-	2001
VOLVO	S60	5 CIL, 2.3 L	2001	-	2001
VOLVO	S40	4 CIL, 1.9 L	2001	-	2000
VOLVO	V70	5 CIL, 2.4 L	2001	-	1999

### T312

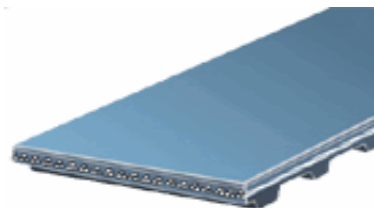

HONDA	CIVIC	4 CIL, 1.7 L	2004	-	2004
HONDA	CIVIC	4 CIL, 1.7 L	2005	-	2001

### T317

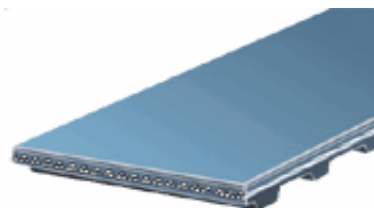

153 DIENTES

VOLKSWAGEN	PASSAT	4 CIL, 1.8 L	2003	-	2002
VOLKSWAGEN	PASSAT	4 CIL, 1.8 L	2001	-	1999
AUDI	A4	4 CIL, 1.8 L	2001	-	1999

### T319

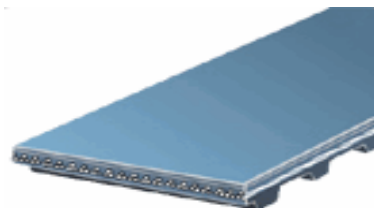

VOLVO	S80	6 CIL, 2.8 L	2001	-	2000
-------	-----	--------------	------	---	------



## Aplicación por Producto

VOLVO	S80	6 CIL, 2.9 L	2005 - 2000
-------	-----	--------------	-------------

### T320

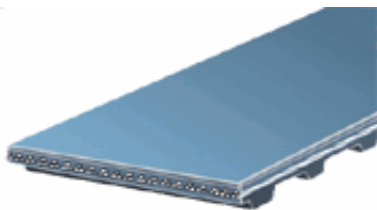

mitsubishi	MONTERO	V-6, 3.8 L	2007 - 2004
------------	---------	------------	-------------

### T321

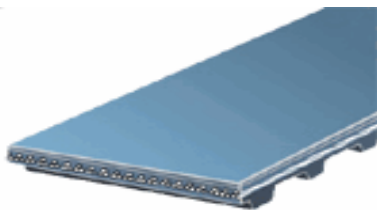

VOLKSWAGEN	JETTA	4 CIL, 1.9 L DIESE2004	- 2000
------------	-------	------------------------	--------

VOLKSWAGEN	CRAFTER	5 CIL, 2.5 L TDI	2008 - 2010
------------	---------	------------------	-------------

### T324

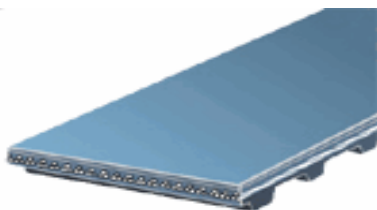

HYUNDAI	VERNA	4 CIL, 1.5 L	2006 - 2004
---------	-------	--------------	-------------

### T326

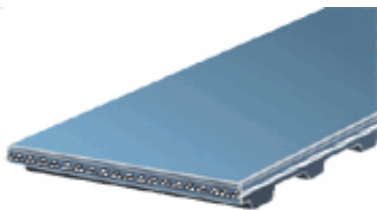

LAND ROVER	FREELANDER	V-6, 2.5 L	2005 - 2002
------------	------------	------------	-------------

### T327

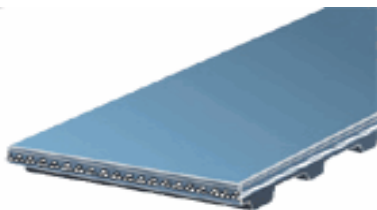

LAND ROVER	FREELANDER	V-6, 2.5 L	2002 - 2005
------------	------------	------------	-------------

### T328

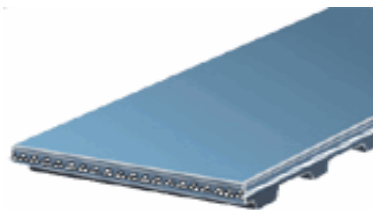

SUBARU	FORESTER	4 CIL, 2.5 L	2007 - 2006
--------	----------	--------------	-------------

SUBARU	OUTBACK	4 CIL, 2.5 L	2007 - 2006
--------	---------	--------------	-------------

SUBARU	IMPREZA	4 CIL, 2.5 L	2007 - 2006
--------	---------	--------------	-------------

SUBARU	LEGACY	4 CIL, 2.5 L	2007 - 2006
--------	--------	--------------	-------------

### T329

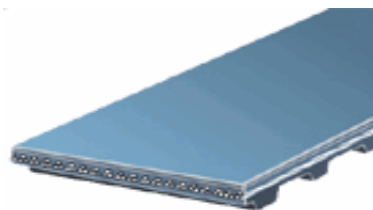

ACURA	TL	V-6, 3.2 L	2008 - 2006
-------	----	------------	-------------

HONDA	PILOT	V-6, 3.5 L	2007 - 2010
-------	-------	------------	-------------

HONDA	ACCORD	V-6, 3.5 L	2008 - 2010
-------	--------	------------	-------------

ACURA	RL	V-6, 3.5 L	2008 - 2006
-------	----	------------	-------------

HONDA	ODYSSEY	V-6, 3.5 L	2007 - 2010
-------	---------	------------	-------------

ACURA	RL	V-6, 3.7 L	2009 - 2010
-------	----	------------	-------------

ACURA	MDX	V-6, 3.7 L	2007 - 2010
-------	-----	------------	-------------

HONDA	ACCORD	V-6, 3.0 L	2004 - 2004
-------	--------	------------	-------------

ACURA	MDX	V-6, 3.5 L	2006 - 2006
-------	-----	------------	-------------

HONDA	RIDGELINE	V-6, 3.5 L	2007 - 2010
-------	-----------	------------	-------------

ACURA	TSX	V-6, 3.5 L	2010 - 2010
-------	-----	------------	-------------

ACURA	TL	V-6, 3.5 L	2008 - 2010
-------	----	------------	-------------

ACURA	TL	V-6, 3.7 L	2009 - 2010
-------	----	------------	-------------

HONDA	ACCORD	V-6, 3.0 L	2007 - 2005
-------	--------	------------	-------------

### T330

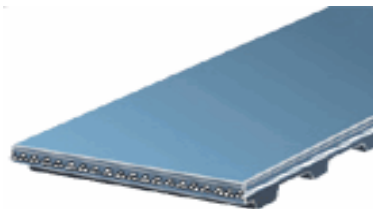

AUDI	A4	V-6, 3.0 L	2003 - 2003
------	----	------------	-------------

AUDI	A4	V-6, 3.0 L	2004 - 2006
------	----	------------	-------------

### T331

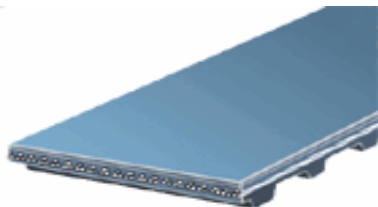

VOLVO	XC90	5 CIL, 2.5 L	2003 - 2006
VOLVO	C30	5 CIL, 2.5 L	2008 - 2010
VOLVO	S60	5 CIL, 2.5 L	2006 - 2004
VOLVO	S60	5 CIL, 2.4 L	2003 - 2003
VOLVO	S40	4 CIL, 1.9 L	2004 - 2002
VOLVO	S80	5 CIL, 2.5 L	2006 - 2005
VOLVO	C70	5 CIL, 2.3 L	2003 - 2002
VOLVO	C70	5 CIL, 2.4 L	2003 - 2002
VOLVO	S40	5 CIL, 2.5 L	2008 - 2007
VOLVO	C30	5 CIL, 2.4 L	2008 - 2010
VOLVO	S40	5 CIL, 2.4 L	2008 - 2005

### T334

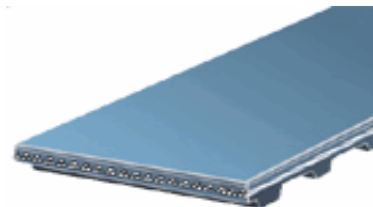

VOLKSWAGEN	GTI	4 CIL, 2.0 L TURB	2008 - 2007
SEAT	ALTEA	4 CIL, 2.0 L	2008 - 2006
VOLKSWAGEN	GOLF	4 CIL, 2.0 L	2006 - 2006
VOLKSWAGEN	JETTA	4 CIL, 2.0 L	2008 - 2010
VOLKSWAGEN	PASSAT	4 CIL, 2.0 L	2008 - 2006
AUDI	A4	4 CIL, 2.0 L	2007 - 2007
VOLKSWAGEN	GLI	4 CIL, 2.0 L TURB	2008 - 2007
SEAT	TOLEDO	4 CIL, 2.0 L	2007 - 2006
AUDI	A3	4 CIL, 2.0 L	2007 - 2008
SEAT	LEON	4 CIL, 2.0 L	2007 - 2006

### T332

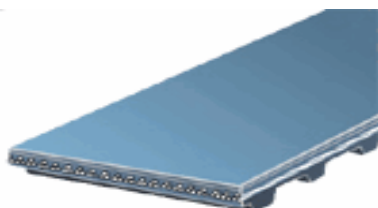

MITSUBISHI	OUTLANDER	4 CIL, 2.4 L	2006 - 2004
MITSUBISHI	GRANDIS	4 CIL, 2.4 L	2008 - 2007
MITSUBISHI	GALANT	4 CIL, 2.4 L	2006 - 2006
MITSUBISHI	LANCER	4 CIL, 2.4 L	2006 - 2004

### T335

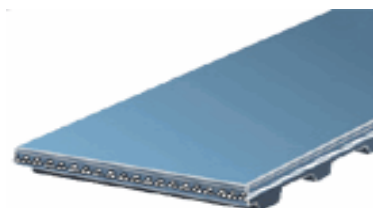

SUZUKI	SWIFT	4 CIL, 1.6 L	2007 - 2008
CHEVROLET	AVEO	4 CIL, 1.6 L	2008 - 2009
PONTIAC	G3	4 CIL, 1.6 L	2008 - 2006

### T333

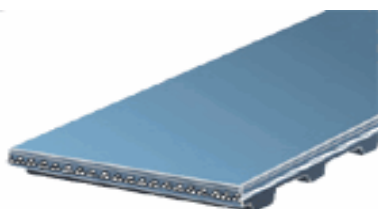

VOLKSWAGEN	JETTA	4 CIL, 1.9 L DIESE	2007 - 2005
VOLKSWAGEN	BORA	4 CIL, 1.9 L DIESE	2007 - 2007
VOLKSWAGEN	EUROVAN	4 CIL, 1.9 L DIESE	2008 - 2009

### T338

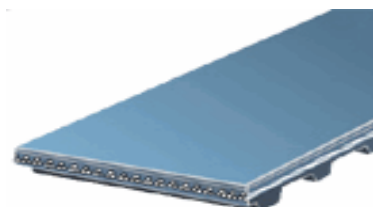

SUZUKI	SWIFT	4 CIL, 1.6 L	2009 - 2009
CHEVROLET	CRUZE	4 CIL, 1.8 L	2010 - 2011
CHEVROLET	ASTRA	4 CIL, 1.8 L	2007 - 2009

### T339

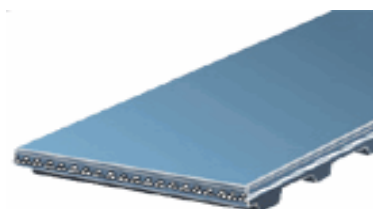

## Aplicación por Producto

MITSUBISHI	OUTLANDER	V-6, 3.0 L	2007 - 2008
------------	-----------	------------	-------------

### T901

### T601

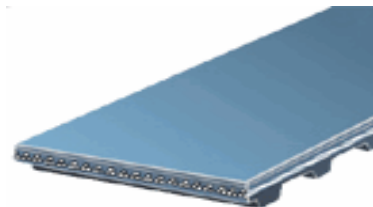
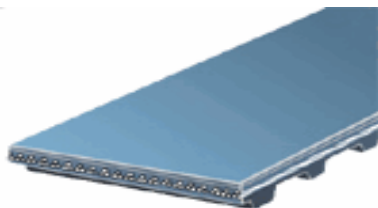

FIAT	PALIO	4 CIL, 1.6 L	2006 - 2003
FIAT	PALIO ADVENTURE	4 CIL, 1.6 L	2006 - 2003

PEUGEOT	206	4 CIL, 1.4 L	2002 - 1998
---------	-----	--------------	-------------

### T901A

### T724

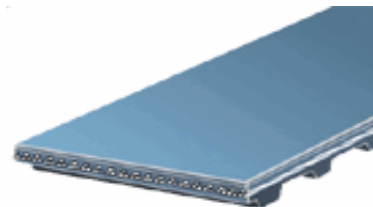
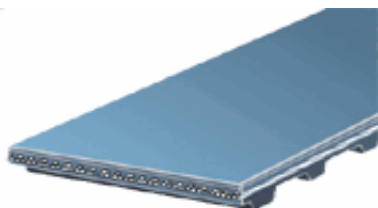

MITSUBISHI	L200	4 CIL, 2.5 L	2008 - 2009
HYUNDAI	H100	4 CIL, 2.5 L DIESE2006	- 2010
HYUNDAI	H100 VANWAGON	4 CIL, 2.5 L DIESE2009	- 2010

PEUGEOT	206	4 CIL, 1.4 L	2008 - 2002
---------	-----	--------------	-------------

## TCKS & COMPONENTES

### TCK1013

### T739

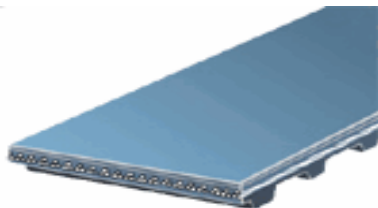

VOLKSWAGEN	EUROVAN	5 CIL, 2.5 L	2002 - 2003
------------	---------	--------------	-------------

HYUNDAI	ATOS	4 CIL, 1.1 L	2005 - 2010
HYUNDAI	ATOS	4 CIL, 1.0 L	2000 - 2004

### TCK1022

### T791

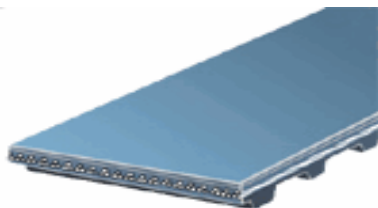

ALFA ROMEO	ALFA 147	4 CIL, 2.0 L	2006 - 2004
------------	----------	--------------	-------------

CHEVROLET	ZAFIRA	4 CIL, 2.0 L	2006 - 2004
CHEVROLET	ASTRA	4 CIL, 2.0 L	2005 - 2004

## Aplicación por Producto

### TCK1094



CHEVROLET	ZAFIRA	4 CIL, 1.8 L	2003 - 2000
CHEVROLET	ASTRA	4 CIL, 1.8 L	2003 - 2000
CHEVROLET	CORSA	4 CIL, 1.4 L	2002 - 2003

### TCK1095



RENAULT	STEPWAY	4 CIL, 1.6 L	2010 - 2010
RENAULT	EUROCLIO	4 CIL, 1.6 L	2007 - 2008
RENAULT	SANDERO	4 CIL, 1.6 L	2010 - 2010
NISSAN	PLATINA	4 CIL, 1.6 L	2007 - 2010
NISSAN	APRIO	4 CIL, 1.6 L	2008 - 2010
RENAULT	KANGOO	4 CIL, 1.6 L	2008 - 2010
RENAULT	CLIO	4 CIL, 1.6 L	2008 - 2009
RENAULT	KANGOO EXPRESS	4 CIL, 1.6 L	2008 - 2009

### TCK139



CHRYSLER	GRAND VOYAGER	V-6, 3.3 L	2000 - 2000
CHRYSLER	VOYAGER	V-6, 3.0 L	2001 - 1996

### TCK1548



VOLKSWAGEN	CROSSFOX	4 CIL, 1.6 L	2008 - 2005
SEAT	CORDOBA	4 CIL, 1.6 L	2007 - 2008
VOLKSWAGEN	GOL	4 CIL, 1.6 L	2009 - 2010

VOLKSWAGEN	SAVEIRO	4 CIL, 1.6 L	2010 - 2010
VOLKSWAGEN	SPORTVAN	4 CIL, 1.6 L	2008 - 2006
VOLKSWAGEN	LUPO	4 CIL, 1.6 L	2008 - 2004
SEAT	IBIZA	4 CIL, 1.6 L	2007 - 2009
VOLKSWAGEN	POLO	4 CIL, 1.6 L	2007 - 2005

### TCK184



HONDA	CR-V	4 CIL, 2.0 L	2001 - 1999
-------	------	--------------	-------------

### TCK192



CHEVROLET	LUMINA	V-6, 3.4 L	1998 - 1997
-----------	--------	------------	-------------

### TCK199



TOYOTA	CAMRY	4 CIL, 2.2 L	2001 - 2001
--------	-------	--------------	-------------

### TCK201



MITSUBISHI	LANCER	4 CIL, 2.0 L	2007 - 2008
------------	--------	--------------	-------------

### TCK203



CHEVROLET	CHEVY	4 CIL, 1.6 L	2009	-	2010
CHEVROLET	CHEVY C2	4 CIL, 1.6 L	2008	-	2004
CHEVROLET	CHEVY C2 SEDAN	4 CIL, 1.6 L	2008	-	2004
CHEVROLET	CHEVY PICK-UP	4 CIL, 1.6 L	2006	-	2002

### TCK244

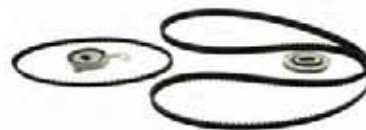

HONDA	ACCORD	4 CIL, 2.3 L	2002	-	1998
-------	--------	--------------	------	---	------

### TCK245



CHRYSLER	CIRRUS	4 CIL, 2.0 L	2000	-	2000
----------	--------	--------------	------	---	------

### TCK212



CHEVROLET	TRACKER	4 CIL, 1.6 L	2000	-	1998
-----------	---------	--------------	------	---	------

### TCK249



NISSAN	QUEST	V-6, 3.0 L	1998	-	1997
NISSAN	QUEST	6 CIL, 3.3 L	2002	-	2002
NISSAN	FRONTIER	V-6, 3.3 L	2004	-	1999
NISSAN	PATHFINDER	V-6, 3.3 L	2000	-	1997
NISSAN	QUEST	V-6, 3.3 L	2001	-	1999
NISSAN	XTERRA	V-6, 3.3 L	2002	-	2000

### TCK224



HONDA	CIVIC	4 CIL, 1.6 L	2000	-	1997
-------	-------	--------------	------	---	------

### TCK227



HONDA	CIVIC	4 CIL, 1.6 L	2000	-	1999
-------	-------	--------------	------	---	------

### TCK250



FORD	CONTOUR	4 CIL, 2.0 L	1997	-	1997
------	---------	--------------	------	---	------



### TCK257



TOYOTA	CAMRY	V-6, 3.0 L	2002 - 2001
TOYOTA	SIENNA	V-6, 3.0 L	2003 - 2000

### TCK271



TOYOTA	4 RUNNER	V-6, 3.4 L	2002 - 2002
--------	----------	------------	-------------

### TCK259



CHRYSLER	SEBRING	V-6, 2.5 L	2000 - 1996
DODGE	STRATUS	V-6, 3.0 L	2003 - 2001
CHRYSLER	SEBRING	V-6, 3.0 L	2004 - 2001
MITSUBISHI	ECLIPSE	V-6, 3.0 L	2005 - 2004

### TCK273



CHEVROLET	LUMINA	V-6, 3.4 L	1997 - 1996
-----------	--------	------------	-------------

### TCK262



VOLKSWAGEN	GTI	4 CIL, 2.0 L	2000 - 1999
------------	-----	--------------	-------------

### TCK262A



VOLKSWAGEN	CABRIO	4 CIL, 2.0 L	1996 - 1996
------------	--------	--------------	-------------

### TCK276



FORD	RANGER	4 CIL, 2.5 L	2001 - 1998
------	--------	--------------	-------------

### TCK283



FORD	FOCUS	4 CIL, 2.0 L	2004 - 2000
FORD	ESCORT	4 CIL, 2.0 L	2002 - 1997

### TCK285



Interference engine application

SAAB	9 - 5	V-6, 3.0 L	2003 - 2000
------	-------	------------	-------------

## Aplicación por Producto

SAAB	9 - 5	V-6, 3.0 L	2003 - 2003
CADILLAC	CATERA	V-6, 3.0 L	1999 - 1998

### TCK294A



### TCK285A



FORD	CONTOUR	4 CIL, 2.0 L	2000 - 1999
FORD	ESCORT	4 CIL, 2.0 L	2002 - 1999
FORD	FOCUS	4 CIL, 2.0 L	2001 - 2001
MERCURY	MYSTIQUE	4 CIL, 2.0 L	2000 - 1999
FORD	FOCUS	4 CIL, 2.0 L	2003 - 2000
FORD	FOCUS	4 CIL, 2.0 L	2006 - 2004
FORD	ZX2	4 CIL, 2.0 L	2003 - 2003

CADILLAC	CATERA	V-6, 3.0 L	2001 - 1999
----------	--------	------------	-------------

### TCK286



### TCK294B



HONDA	ACCORD	V-6, 3.0 L	2001 - 1998
-------	--------	------------	-------------

FORD	ESCAPE	4 CIL, 2.0 L	2002 - 2001
------	--------	--------------	-------------

### TCK287



### TCK295



MITSUBISHI	GALANT	V-6, 3.8 L	2007 - 2004
MITSUBISHI	MONTERO SPORT	V-6, 3.5 L	2004 - 2004
MITSUBISHI	ENDEAVOR	V-6, 3.8 L	2007 - 2004
MITSUBISHI	ECLIPSE	V-6, 3.8 L	2007 - 2008

CHRYSLER	300M	V-6, 3.5 L	2002 - 1999
CHRYSLER	CONCORDE	V-6, 3.5 L	2002 - 2002
DODGE	INTREPID	V-6, 3.5 L	2002 - 2000
CHRYSLER	CONCORDE	V-6, 3.2 L	2001 - 1998
DODGE	INTREPID	V-6, 3.2 L	2001 - 1998

### TCK294



### TCK295A



FORD	ESCORT	4 CIL, 2.0 L	2000 - 1998
MERCURY	MYSTIQUE	4 CIL, 2.0 L	2000 - 1998
FORD	CONTOUR	4 CIL, 2.0 L	1999 - 1998

DODGE	CHARGER	V-6, 3.5 L	2009 - 2009
DODGE	JOURNEY	V-6, 3.5 L	2009 - 2010
CHRYSLER	300 C	V-6, 3.5 L	2007 - 2009

## Aplicación por Producto

DODGE	NITRO	V-6, 4.0 L	2009 - 2010
CHRYSLER	TOWN & COUNTRY	V6, 4.0 L	2008 - 2010

### TCK306



AUDI	A4	4 CIL, 1.8 L	2006 - 2006
------	----	--------------	-------------

### TCK309



CHEVROLET	OPTRA	4 CIL, 2.0 L	2008 - 2006
CHEVROLET	OPTRA	4 CIL, 2.0 L	2009 - 2010

### TCK321



VOLKSWAGEN	JETTA	4 CIL, 1.9 L DIESE	2004 - 2000
------------	-------	--------------------	-------------

### TCK329



ACURA	RL	V-6, 3.5 L	2006 - 2008
ACURA	RL	V-6, 3.7 L	2009 - 2010
HONDA	RIDGELINE	V-6, 3.5 L	2008 - 2010
ACURA	TL	V-6, 3.2 L	2006 - 2008
ACURA	TSX	V-6, 3.5 L	2010 - 2010
ACURA	TL	V-6, 3.5 L	2008 - 2010
HONDA	PILOT	V-6, 3.5 L	2008 - 2010
ACURA	TL	V-6, 3.7 L	2009 - 2010
HONDA	ODYSSEY	V-6, 3.5 L	2008 - 2010
HONDA	ACCORD	V-6, 3.5 L	2008 - 2010
ACURA	MDX	V-6, 3.5 L	2006 - 2006
ACURA	MDX	V-6, 3.7 L	2007 - 2010

### TCK296



SEAT	CORDOBA	4 CIL, 2.0 L	2003 - 2007
VOLKSWAGEN	BEETLE	4 CIL, 2.0 L	2005 - 1998
VOLKSWAGEN	JETTA	4 CIL, 2.0 L	2008 - 2010
VOLKSWAGEN	GOLF	4 CIL, 2.0 L	2006 - 1999
SEAT	IBIZA	4 CIL, 2.0 L	2003 - 2009

### TCK297



AUDI	A8	V-8, 4.2 L	2007 - 2007
------	----	------------	-------------

### TCK298



TOYOTA	TUNDRA	V-8, 4.7 L	2008 - 2007
TOYOTA	LAND CRUISER	V-8, 4.7 L	2007 - 2007

### TCK305



CHEVROLET	ASTRA	4 CIL, 2.4 L	2006 - 2004
CHEVROLET	ZAFIRA	4 CIL, 2.4 L	2006 - 2004

### TCK330



AUDI	A4	V-6, 3.0 L	2006	-	2006
------	----	------------	------	---	------

### TCK901A



PEUGEOT	206	4 CIL, 1.4 L	2006	-	2008
---------	-----	--------------	------	---	------

### TCK331



VOLVO	S40	5 CIL, 2.5 L	2008	-	2007
VOLVO	C30	5 CIL, 2.4 L	2008	-	2010
VOLVO	C30	5 CIL, 2.5 L	2008	-	2010
VOLVO	S40	5 CIL, 2.4 L	2008	-	2005
VOLVO	XC90	5 CIL, 2.5 L	2003	-	2006

### TCK335



CHEVROLET	AVEO	4 CIL, 1.6 L	2009	-	2009
SUZUKI	SWIFT	4 CIL, 1.6 L	2008	-	2008

### TCK901



PEUGEOT	206	4 CIL, 1.4 L	2001	-	1998
---------	-----	--------------	------	---	------

## Aplicación por Producto

### Bomba de Dirección Hidráulica

#### BDH-275



FORD	EXPLORER	V-6, 4.0 L	2000	-	1997
------	----------	------------	------	---	------

#### BDH-286



FORD	WINDSTAR	V-6, 3.8 L	2002	-	1999
------	----------	------------	------	---	------

#### BDH-5104



NISSAN	SENTRA	4 CIL, 2.0 L	2002	-	1998
--------	--------	--------------	------	---	------

#### BDH-5155



NISSAN	QUEST	V-6, 3.3 L	2000	-	2000
--------	-------	------------	------	---	------

NISSAN	PATHFINDER	V-6, 3.5 L	1998	-	1997
--------	------------	------------	------	---	------

NISSAN	PATHFINDER	V-6, 3.3 L	1998	-	1997
--------	------------	------------	------	---	------

#### BDH-5459



TOYOTA	CAMRY	V-6, 3.0 L	2002	-	2001
TOYOTA	CAMRY	4 CIL, 2.2 L	2002	-	2001

#### BDH-5535

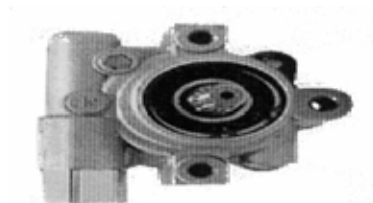

NISSAN	URVAN	4 CIL, 2.4 L	2006	-	2008
--------	-------	--------------	------	---	------

#### BDH-5587



TOYOTA	HIACE	4 CIL, 2.7 L	2006	-	2008
--------	-------	--------------	------	---	------

#### BDH-61607



JEEP	GRAND CHEROKEE	6 CIL, 4.0 L	2001	-	1999
------	----------------	--------------	------	---	------

JEEP	GRAND CHEROKEE	V-8, 4.7 L	2001	-	1999
------	----------------	------------	------	---	------

#### BDH-64610





## Aplicación por Producto

JEEP	LIBERTY	V-6, 3.7 L	2006	-	2002
------	---------	------------	------	---	------

### BDH-7108



DODGE	RAM 1500	V-6, 3.9 L	2005	-	1996
DODGE	RAM 2500	V-8, 5.9 L	2001	-	1999
DODGE	RAM 2500	V-8, 5.2 L	2001	-	1999
DODGE	RAM 2500	V-8, 4.7L	2005	-	2002

### BDH-7111

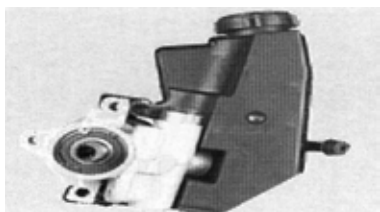

JEEP	GRAND CHEROKEE	6 CIL, 4.0 L	1998	-	1996
------	----------------	--------------	------	---	------

### BDH-7124



FORD	EXPLORER	V-6, 4.0 L	1999	-	1998
------	----------	------------	------	---	------

### BDH-7129



FORD	F-150	V-8, 5.4 L	1999	-	1997
FORD	F-150	V-8, 4.6 L	1999	-	1997
FORD	F-150	V-6, 4.2 L	1999	-	1997

### Ensamble de Dirección Hidráulica

**352350(80310)**

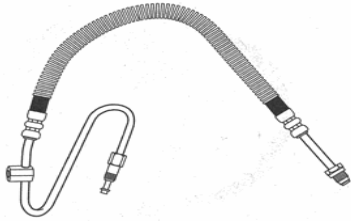

EDH - (44 7/8") - (entrada sensor) 16mm Macho "O" Ring

DODGE	DURANGO	V-8, 4.7 L	2001	-	2001
-------	---------	------------	------	---	------

**352470(80313)**

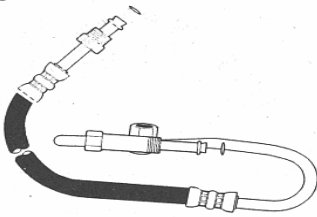

EDH - (49 1/8") - 16mm Macho "O" Ring x 18mm Macho "O" Ring

DODGE	RAM 2500	V-8, 4.7L	2003	-	2002
-------	----------	-----------	------	---	------

**352520(80314)**

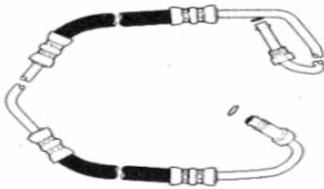

EDH - (59 1/4") - 16mm Macho "O" Ring x 18 mm Macho "O" Ring

CHRYSLER	CIRRUS	4 CIL, 2.4 L	2000	-	1995
CHRYSLER	CIRRUS	4 CIL, 2.0 L	2000	-	2000
DODGE	STRATUS	4 CIL, 2.0 L	2000	-	1995
DODGE	STRATUS	4 CIL, 2.4 L	2000	-	1995

**352650(80315)**

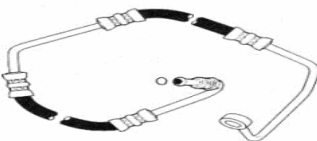

EDH - (58") - 16mm Banjo x 18mm Macho "O" Ring

CHRYSLER	CIRRUS	4 CIL, 2.4 L	2000	-	1999
DODGE	STRATUS	4 CIL, 2.0 L	2000	-	1995
DODGE	STRATUS	4 CIL, 2.4 L	2000	-	1995

**352790(80241)**

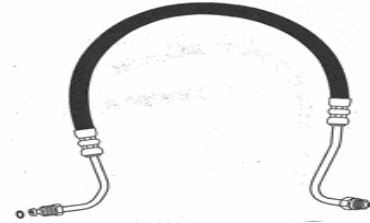

EDH - (35 1/4") - 16mm Macho "O" Ring x 5/16" Macho "O" Ring

FORD	F-250	V-8, 5.4 L	2003	-	2000
------	-------	------------	------	---	------

**352850(80319)**



EDH - (29") - 16mm "O" Ring Giratorio x 5/16" "O" Ring Macho

FORD	F-350 SUPER DUTY	V-8, 5.4 L	2006	-	1999
FORD	SUPER DUTY PICKUP	V-10, 6.8 L	2000	-	2000
FORD	SUPER DUTY PICKUP	V-8, 5.4 L	2000	-	2000
FORD	EXCURSION	V-8, 5.4 L	2002	-	2000

**352860(80320)**



EDH - (27 1/4") - 16mm "O" Ring Giratorio x 5/16" "O" Ring Macho

FORD	F-450 SUPER DUTY	V-10, 6.8 L	2006	-	1999
FORD	EXCURSION	V-10, 6.8 L	2005	-	2005
FORD	EXCURSION	V-10, 6.8 L	2004	-	2000

**352890(80322)**



EDH - (27") - 16mm "O" Ring Giratorio x 16mm "O" Ring Macho

FORD	RANGER	V-6, 4.0 L	2000	-	1999
FORD	RANGER	V-6, 3.0 L	2000	-	1998
FORD	RANGER	4 CIL, 2.5 L	2000	-	1998

### 353090(80328)

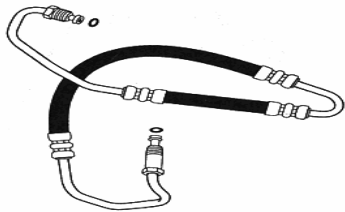

EDH - (48 3/8") - 16mm Macho "O" Ring x 18mm Macho "

JEEP	GRAND CHEROKEE	6 CIL, 4.0 L	2002	-	1998
------	----------------	--------------	------	---	------

### 353110(80329)

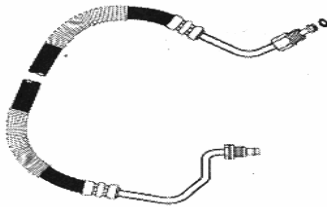

EDH - (33 7/8") - 16mm Macho "O" Ring x 18mm Macho "

CHEVROLET	CAVALIER	4 CIL, 2.2 L	2002	-	2002
-----------	----------	--------------	------	---	------

### 353190(80331)

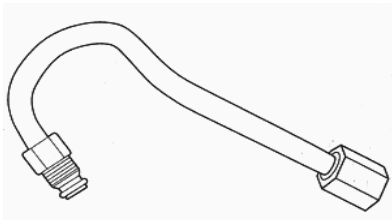

EDH - (10 1/2") - 16mm Hembra "O" Ring x 16mm Macho

CHEVROLET	SILVERADO	V-6, 4.3 L	2000	-	1999
CHEVROLET	SILVERADO	V-8, 5.3 L	2001	-	2000
CHEVROLET	SILVERADO	V-8, 6.0 L	2001	-	2000

### 353600(80287)

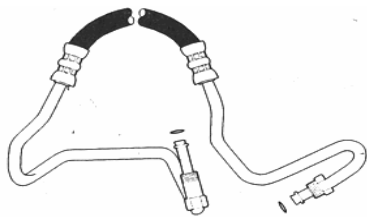

EDH - (43") - 16mm Macho "O" Ring x 18mm Macho "O" F

CHEVROLET	EXPRESS	V-8, 5.0 L	2000	-	2000
CHEVROLET	EXPRESS CARGO VAN	V-8, 5.7 L	2000	-	1998

### 353920(80235)

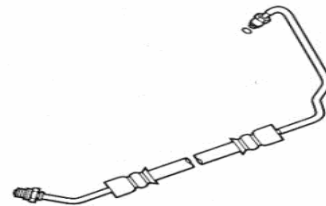

EDH - (30 3/4") - 16mm Macho "O" Ring x 5/16" Macho "O

FORD	F SERIES PICKUP	V-6, 4.2 L	2001	-	2000
FORD	LOBO	V-8, 4.6 L	2002	-	2002
FORD	F-250	V-8, 5.4 L	1999	-	1997
FORD	F-250	V-8, 4.6 L	2000	-	2000
FORD	F-150	V-8, 5.4 L	1999	-	1997
FORD	F-150	V-8, 4.6 L	1999	-	1997
LINCOLN	NAVIGATOR	V-8, 5.4 L	2000	-	1998
FORD	F SERIES PICKUP	V-8, 4.6 L	2001	-	2000
FORD	LOBO	V-8, 5.4 L	2003	-	2003
FORD	EXPEDITION	V-8, 4.6 L	1999	-	1997
FORD	F SERIES PICKUP	V-8, 5.4 L	2002	-	2000

### 353930(80236)

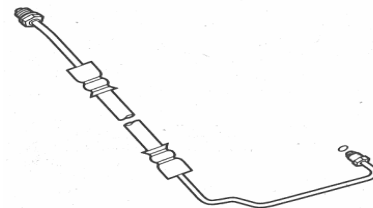

EDH - (34 1/4") - 16mm Hembra "O" Ring x 5/16" Macho "

FORD	F-150	V-6, 4.2 L	2006	-	1997
------	-------	------------	------	---	------

### 353950(80263)

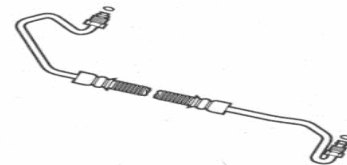

EDH - (38 1/2") - 16mm Macho "O" Ring x 18 mm Macho "

CHEVROLET	SUBURBAN	V-8, 5.7 L	1996	-	1996
-----------	----------	------------	------	---	------

### 354020(80250)

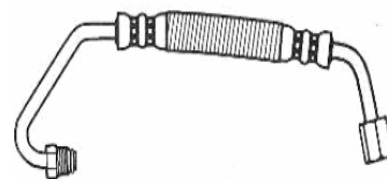

EDH - (15 3/4") - 16mm Macho "O" Ring x 16 mm Hembra

FORD	ESCORT	4 CIL, 2.0 L	2002	-	1998
------	--------	--------------	------	---	------

## Aplicación por Producto

FORD ZX2 4 CIL, 2.0 L 2002 - 2000

**359530(80266)**

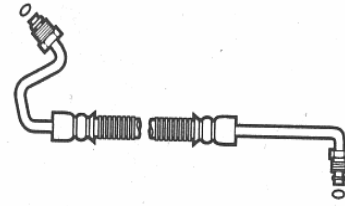

EDH - (37 1/2") - 16mm Macho "O" Ring x 18mm Macho

CHEVROLET C y K SERIES PICKUP V-6, 4.3 L 1998 - 1997

**356130(71399)**

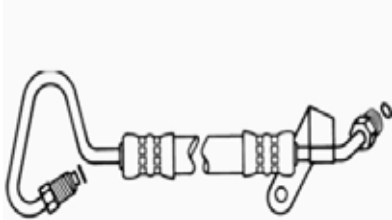

EDH - (31 5/16") - 16mm Macho "O" Ring x 18mm Macho

DODGE RAM CHARGER V-8, 5.9 L 1994 - 1993

DODGE RAM CHARGER V-8, 5.2 L 1994 - 1993

**359190(71668)**

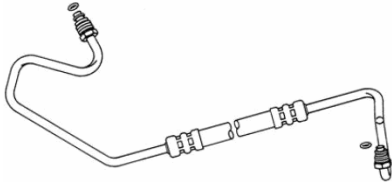

EDH - (37 5/16") - 16mm Macho "O" Ring x 18mm Macho

CHEVROLET SUBURBAN V-8, 5.7 L 1993 - 1993

**359210(71404)**

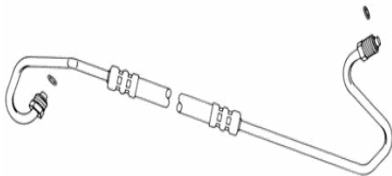

EDH - (38") - 16mm Macho "O" Ring x 18mm Macho "O" F

CHEVROLET BLAZER V-6, 4.3 L 1995 - 1993

CHEVROLET S-10 V-6, 4.3 L 1995 - 1993

**359340(91717)**

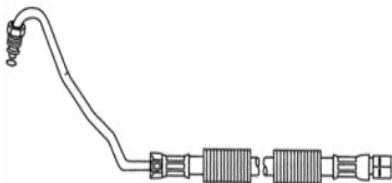

EDH - (27 1/4") - (entrada sensor) 16mm Hembra "O" Ring

CHEVROLET CAVALIER V-6, 3.1 L 1994 - 1993

CHEVROLET CAVALIER V-6, 2.8 L 1994 - 1993

**360090(71824)**

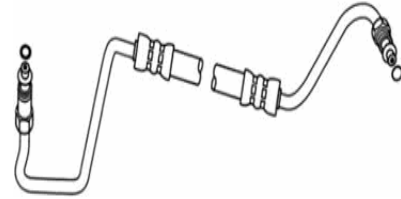

EDH - (38") - 16mm Macho "O" Ring x 18mm Macho "O" F

JEEP CHEROKEE 6 CIL, 4.0 L 1996 - 1996

**360110(71844)**

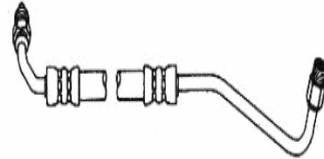

EDH - (26 1/2") - 5/16" "O" Ring Largo Giratorio x 16 mm"

FORD AEROSTAR V-6, 4.0 L 1997 - 1993

**360120(71827)**



EDH - (31 1/4") - (entrada sensor) 5/16" Macho flare inv. x

MERCURY GRAND MARQUIS V-8, 4.6 L 1994 - 1993

FORD CROWN VICTORIA V-8, 4.6 L 1994 - 1993

LINCOLN TOWN CAR V-8, 4.6 L 1993 - 1993

### 360180(71840)

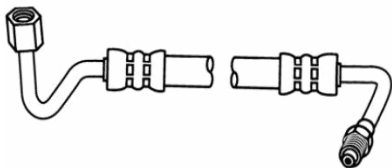

EDH - (17 7/8") - 16mm Hembra x 16mm "O" Ring Giratori

FORD	ESCORT	4 CIL, 1.9 L	1996	-	1994
------	--------	--------------	------	---	------

### 360460(71843)

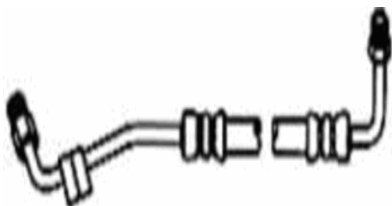

EDH - (27 1/4") - (entrada sensor) 5/16" "O" Ring Largo C

FORD	AEROSTAR	V-6, 3.0 L	1993	-	1993
------	----------	------------	------	---	------

### 360470(91735)

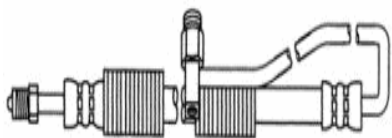

EDH - (53 3/4") - (entrada sensor) 5/16" "O" Ring Largo Gi

FORD	TOPAZ	4 CIL, 2.3 L	1994	-	1993
------	-------	--------------	------	---	------

### 360520(71874)

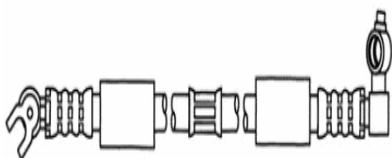

EDH - (21 3/8") - 14mm Hembra x 16mm Banjo

NISSAN	SENTRA	4 CIL, 1.6 L	1997	-	1995
NISSAN	TSURU	4 CIL, 1.6 L	1997	-	1993

### 360530(71878)

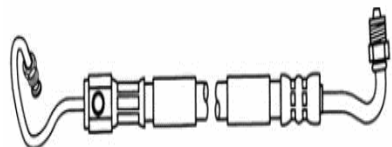

EDH - (28 3/4") - (entrada sensor) 5/16" Macho flare inv. x

FORD	RANGER	V-6, 3.0 L	1996	-	1996
FORD	RANGER	4 CIL, 2.3 L	1997	-	1995

### 360550(80020)



EDH - (31 3/8") - 3/8" "O" Ring Giratorio (Tipo II)

FORD	TOPAZ	4 CIL, 2.3 L	1994	-	1993
------	-------	--------------	------	---	------

### 360600(71875)

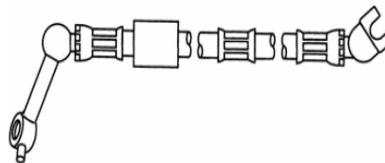

EDH - (30") - 14mm Hembra x 16mm Banjo

NISSAN	TSURU	4 CIL, 2.0 L	1996	-	1993
--------	-------	--------------	------	---	------

### 360970(71823)

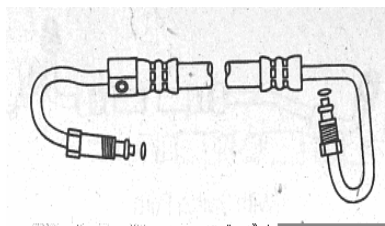

EDH - (32 3/4") - (entrada sensor) 16mm Macho "O" Ring

JEEP	CHEROKEE	4 CIL, 2.5 L	1998	-	1995
------	----------	--------------	------	---	------

### 360980(71817)

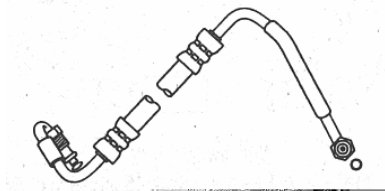

EDH - (36 1/8") - 16mm Macho "O" Ring x 18mm Macho "C"

DODGE	DURANGO	V-8, 5.2 L	1998	-	1998
-------	---------	------------	------	---	------



### 360990(71780)

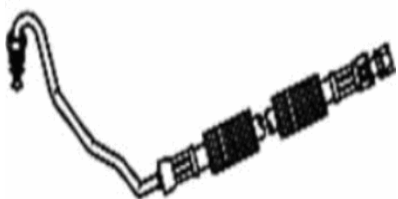

EDH - (28 1/2") - (entrada sensor) 16mm Hembra "O" Ring

PONTIAC	GRAND AM	V-6, 3.1 L	1998	-	1997
PONTIAC	GRAND AM	4 CIL, 2.4 L	1998	-	1998

### 361020(71851)



EDH - (28 1/8") - (entrada sensor) 5/16" Macho flare inv. x

FORD	F-350 SUPER DUTY	V-8, 5.0 L	1995	-	1993
FORD	F-350 SUPER DUTY	V-8, 5.8 L	1995	-	1993

### 361110(80048)

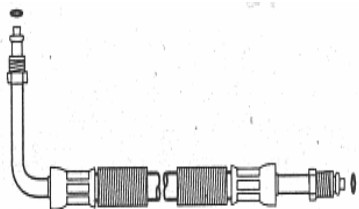

EDH - (22 1/16") - 16mm Macho "O" Ring x 18mm Macho

CHEVROLET	CAMARO Z28	V-6, 3.8 L	2002	-	1996
-----------	------------	------------	------	---	------

### 361260(80264)

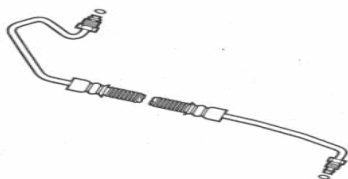

EDH - (39") - 16mm Macho "O" Ring x 18mm Macho "O" f

CHEVROLET	SUBURBAN	V-8, 5.7 L	1999	-	1997
CHEVROLET	C y K SERIES PICKUP	V-8, 5.7 L	1999	-	1997
CHEVROLET	C y K SERIES PICKUP	V-8, 5.0 L	1999	-	1997

### 361330(80234)

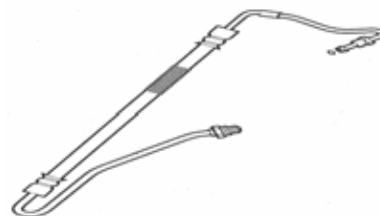

EDH - (45 1/4") - 16mm Hembra "O" Ring x 5/16" Macho \*

MERCURY	GRAND MARQUIS	V-8, 4.6 L	2002	-	1998
LINCOLN	TOWN CAR	V-8, 4.6 L	2002	-	1998
FORD	CROWN VICTORIA	V-8, 4.6 L	2002	-	1998

### 362780(80045)

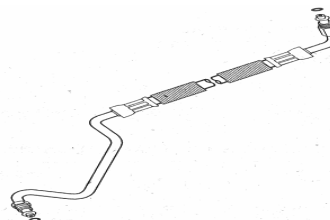

EDH - (33 1/4") - 16mm Macho "O" Ring x 18mm Macho "f

CHEVROLET	REGAL	V-6, 3.8 L	1996	-	1996
-----------	-------	------------	------	---	------

### 362800(80049)



EDH - (37") - 16mm Macho "O" Ring x 18mm Macho "O" f

PONTIAC	SUNFIRE	4 CIL, 2.2 L	1995	-	1995
CHEVROLET	CAVALIER	4 CIL, 2.2 L	1995	-	1995

### 362810(80050)



EDH - (34") - 16mm Hembra "O" Ring x 18mm Macho "O" f

PONTIAC	SUNFIRE	4 CIL, 2.4 L	1998	-	1996
CHEVROLET	CAVALIER	4 CIL, 2.4 L	1999	-	1996
CHEVROLET	CAVALIER	4 CIL, 2.3 L	1995	-	1995
PONTIAC	SUNFIRE	4 CIL, 2.3 L	1995	-	1995

## Aplicación por Producto

### 364660(91644)

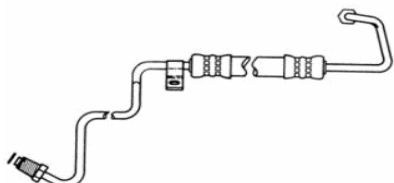

EDH - (44 1/2") - 16mm Macho "O" Ring x 18mm Macho "O" Ring

CHRYSLER	TOWN & COUNTRY	V-6, 3.8 L	1995	-	1994
CHRYSLER	TOWN & COUNTRY	V-6, 3.3 L	1994	-	1993

### 364710(71411)



EDH - (43 1/16") - (entrada sensor) 16mm Macho "O" Ring

CHEVROLET	CAVALIER	4 CIL, 2.2 L	1994	-	1993
-----------	----------	--------------	------	---	------

### 364900(91740)



EDH - (39 1/8") - 16mm "O" Ring giratorio x 16mm "O" R

FORD	ESCORT	4 CIL, 1.8 L	1996	-	1994
------	--------	--------------	------	---	------

### 365060(91707)



EDH - (43 3/8") - 16mm Macho "O" Ring x 18mm Macho "O" Ring

CHEVROLET	REGAL	V-6, 3.8 L	1995	-	1994
-----------	-------	------------	------	---	------

### 365090(71804)

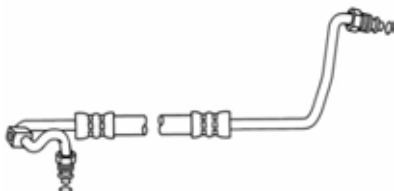

EDH - (40 5/8") - (entrada sensor) 16mm Macho "O" Ring

DODGE	SPIRIT	V-6, 3.0 L	1994	-	1994
DODGE	SPIRIT	4 CIL, 2.5 L	1994	-	1993

### 365110(80061)



EDH - (42") - 16mm Macho "O" Ring x 18mm Macho "O" F

CHRYSLER	CONCORDE	V-6, 3.3 L	1996	-	1993
DODGE	INTREPID	V-6, 3.3 L	1996	-	1993
CHRYSLER	NEW YORKER	V-6, 3.3 L	1996	-	1993

### 365260(80070)

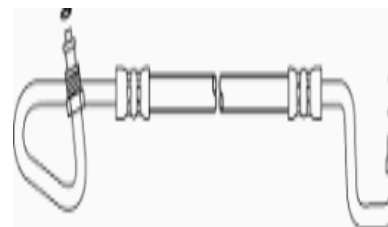

EDH - (47 3/4") - 16mm Macho "O" Ring x 18mm Macho "O" F

DODGE	RAM 2500	V-8, 5.9 L	2001	-	1999
DODGE	RAM 2500	V-8, 5.2 L	2001	-	1999
DODGE	RAM 1500	V-6, 3.9 L	2001	-	1999
DODGE	RAM CHARGER	V-8, 5.2 L	1994	-	1994
DODGE	RAM CHARGER	V-8, 5.9 L	2001	-	1994
DODGE	RAM SERIES PICKUP	V-8, 5.2 L	2001	-	1994
DODGE	RAM WAGON 3500	V-8, 5.2 L	2000	-	2000
DODGE	RAM SERIES PICKUP	V-8, 5.9 L	2001	-	1994
DODGE	RAM SERIES PICKUP	V-6, 3.9 L	2001	-	1994

### 365370(91960)

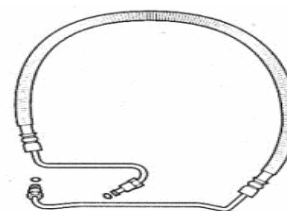

EDH - (61 1/2") - 16mm Macho "O" Ring x 18 mm Macho "O" F

CHEVROLET	CUTLASS	V-6, 3.1 L	1998	-	1997
PONTIAC	GRAND AM	V-6, 3.4 L	2005	-	2000
CHEVROLET	MALIBU	V-6, 3.1 L	2003	-	1997

## Aplicación por Producto

**365970(91650)**

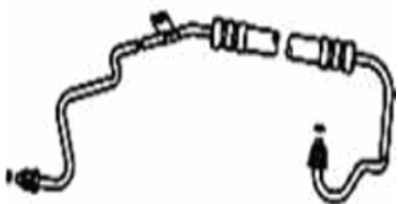

EDH - (53 3/4") - 16mm Macho "O" Ring x 18mm Macho "

DODGE	CARAVAN	4 CIL, 2.5 L	1995	-	1993
-------	---------	--------------	------	---	------

**366190(91675)**

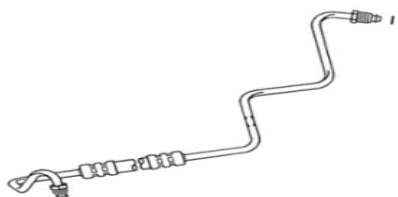

EDH - (45 5/16") - 16mm Macho "O" Ring x 18mm Macho

DODGE	ADVENTURER	V-6, 3.3 L	1995	-	1995
CHRYSLER	GRAND VOYAGER	V-6, 3.8 L	1995	-	1994

**366290(91695)**

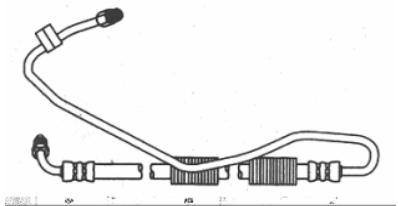

EDH - (79 3/4") - (entrada sensor) 5/16" "O" Ring Largo C

FORD	AEROSTAR	V-6, 3.0 L	1997	-	1994
------	----------	------------	------	---	------

**366400(91743)**



EDH - (43 3/4") - 5/16" Macho Flare Inv. x 16 mm "O" Ring

FORD	F-150	V-6, 4.9 L	1996	-	1995
------	-------	------------	------	---	------

**366420(91710)**

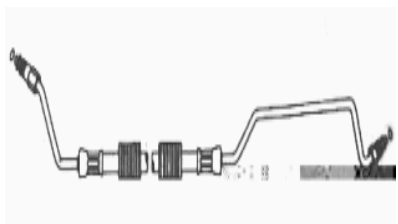

EDH - (44 5/8") - 16mm Macho "O" Ring x 18mm Macho "

OLDSMOBILE	SILHOUETTE	V-6, 3.8 L	1995	-	1994
------------	------------	------------	------	---	------

**366440(71826)**

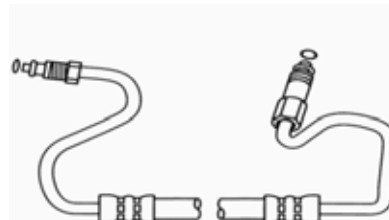

EDH - (40 1/4") - 16mm Macho "O" Ring x 18mm Macho "

JEEP	GRAND CHEROKEE	6 CIL, 4.0 L	1995	-	1994
------	----------------	--------------	------	---	------

**366510(91823)**



EDH - (50 1/8") - 16mm Macho "O" Ring x 18mm Macho "

CHRYSLER	NEW YORKER	V-6, 3.5 L	1997	-	1993
CHRYSLER	CONCORDE	V-6, 3.5 L	1996	-	1993
DODGE	INTREPID	V-6, 3.5 L	1997	-	1993

**366550(91658)**

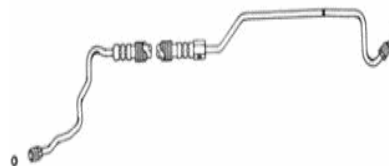

EDH - (49 15/16") - (entrada sensor) 16mm Macho "O" Ring

CHEVROLET	CENTURY	V-6, 3.1 L	1993	-	1993
-----------	---------	------------	------	---	------

**366970(91508)**



EDH - (50 3/4") - 16mm Macho "O" Ring x 18mm Macho "

DODGE	SHADOW	4 CIL, 2.2 L	1994	-	1993
DODGE	SPIRIT	4 CIL, 2.5 L	1994	-	1994
DODGE	SHADOW	4 CIL, 2.5 L	1995	-	1993

## Aplicación por Producto

**367370(91674)**

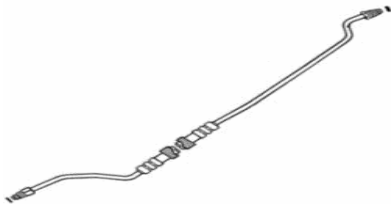

EDH - (76 3/16") - 16mm Macho "O" Ring x 18mm Macho

OLDSMOBILE	SILHOUETTE	V-6, 3.8 L	1995	-	1993
OLDSMOBILE	SILHOUETTE	V-6, 3.1 L	1995	-	1993

**367460(91767)**

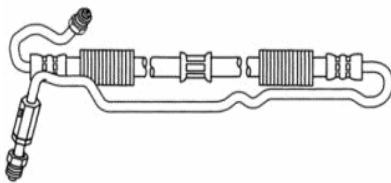

EDH - (62 3/4") - (entrada sensor 16mm "O" Ring Giratoric

MERCURY	COUGAR XR7	V-6, 3.8 L	1994	-	1993
---------	------------	------------	------	---	------

**367490(91709)**

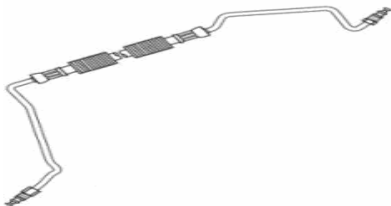

EDH - (47 1/4") - 16mm Macho "O" Ring x 18mm Macho "

CHEVROLET	LUMINA	V-6, 3.4 L	1993	-	1993
-----------	--------	------------	------	---	------

**368500(91730)**

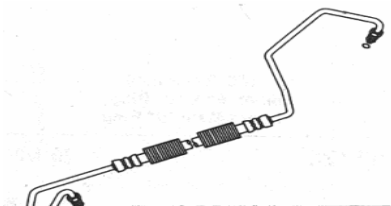

EDH - (55 1/2") - 16mm Macho "O" Ring x 18mm Macho "

CHEVROLET	C y K SERIES PICKUP	V-8, 5.7 L	1994	-	1993
-----------	---------------------	------------	------	---	------

**368690(91824)**

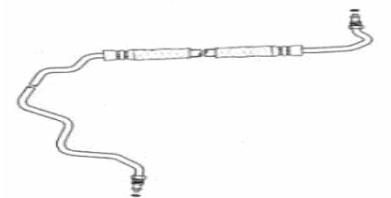

EDH - (54 1/4") - 16mm Macho "O" Ring x 18 mm Macho "

CHRYSLER	GRAND VOYAGER	V-6, 3.8 L	1998	-	1996
DODGE	CARAVAN	4 CIL, 2.4 L	1997	-	1997

**368700(91825)**



EDH - (56 5/8") - 16mm Macho "O" Ring x 18 mm Macho "

CHRYSLER	VOYAGER	V-6, 3.0 L	1998	-	1996
DODGE	CARAVAN	V-6, 3.3 L	1998	-	1996
CHRYSLER	VOYAGER	V-6, 3.3 L	1998	-	1996
CHRYSLER	TOWN & COUNTRY	V-6, 3.8 L	2000	-	1999

**370950(91737)**

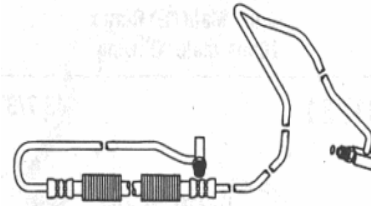

EDH - (92 5/8") - (entrada sensor) 16mm "O" Ring Giratori

MERCURY	SABLE	V-6, 3.8 L	1993	-	1993
---------	-------	------------	------	---	------

**60401**



EDH - (87") - 14mm Banjo x 16mm Banjo

VOLKSWAGEN	JETTA	4 CIL, 2.0 L	2007	-	2000
VOLKSWAGEN	JETTA	4 CIL, 1.8 L	2006	-	2000

**60402**



EDH - (60") - 14mm Banjo x 12mm Banjo

VOLKSWAGEN	POINTER	4 CIL, 2.0 L	2006	-	2002
VOLKSWAGEN	POINTER	4 CIL, 1.8 L	2006	-	2000

71798

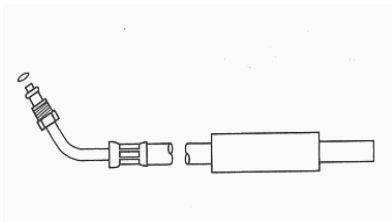

EDH - (32") - 16mm Macho "O" Ring

CHEVROLET	CAVALIER	4 CIL, 2.2 L	2005	-	2005
PONTIAC	SUNFIRE	4 CIL, 2.2 L	2005	-	2005

80041

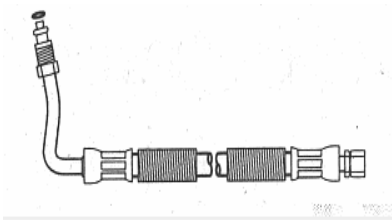

EDH - (24") - 16mm Hembra "O" Ring x 18mm Macho "O"

PONTIAC	GRAND AM	4 CIL, 2.4 L	1998	-	1998
---------	----------	--------------	------	---	------

80051

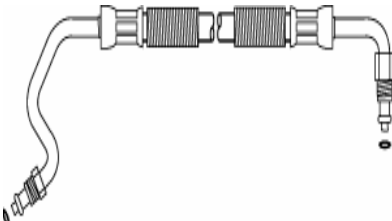

EDH - (38 1/4") - 16mm Macho "O" Ring x 18mm Macho "

PONTIAC	SUNFIRE	4 CIL, 2.4 L	2001	-	2000
CHEVROLET	CAVALIER	4 CIL, 2.2 L	2002	-	1996
PONTIAC	SUNFIRE	4 CIL, 2.2 L	2002	-	1996

80053



EDH - (38 5/8") - (entrada sensor) 16mm Macho "O" Ring

CHEVROLET	S-10	4 CIL, 2.2 L	2003	-	1995
CHEVROLET	S-10	V-6, 4.3 L	1999	-	1997

80076



EDH - (29 3/4") - 5/16" Macho Flare Inv. x 16 mm "O" Ring

LINCOLN	TOWN CAR	V-8, 4.6 L	1996	-	1994
MERCURY	GRAND MARQUIS	V-8, 4.6 L	1996	-	1995
FORD	CROWN VICTORIA	V-8, 4.6 L	1996	-	1995

80080

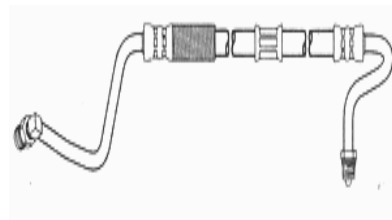

EDH - (49") - 16mm "O" Ring Giratorio x 9/16 "O" Ring Lar

FORD	MUSTANG	V-8, 5.0 L	1995	-	1994
------	---------	------------	------	---	------

80086

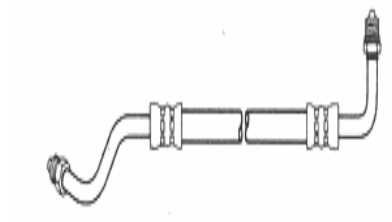

EDH - (28 3/8") - 16mm "O" Ring Giratorio x 16mm "O" Rir

FORD	EXPLORER	V-6, 4.0 L	2002	-	1995
------	----------	------------	------	---	------

80100

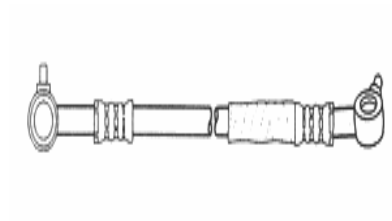

EDH - (28 3/4") - 16mm Banjo x 16mm Banjo

NISSAN	MAXIMA	V-6, 3.0 L	1994	-	1993
--------	--------	------------	------	---	------



## Aplicación por Producto

**80101**



EDH - (26 3/4") - 16mm Banjo x 16mm Banjo

NISSAN	MAXIMA	V-6, 3.0 L	2004	-	1995
INFINITI	INFINITI I30	V-6, 3.0 L	2000	-	1997

**80102**

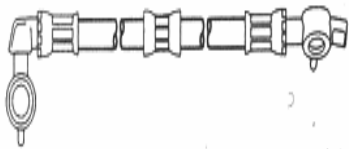

EDH - (22 1/4") - 16mm Banjo x 16mm Banjo

NISSAN	ALTIMA	4 CIL, 2.4 L	1997	-	1994
--------	--------	--------------	------	---	------

**80229**



EDH - (32 1/4") - 16mm Macho "O" Ring x 18mm Macho "

PONTIAC	FIREBIRD TRANS AM	V-8, 5.7 L	2002	-	1998
---------	-------------------	------------	------	---	------

**80230**

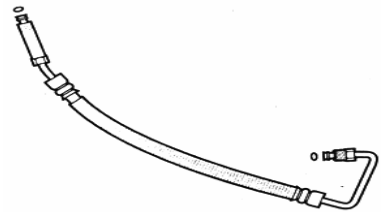

EDH - (25 1/8") - 16mm Macho "O" Ring x 18mm Macho "

CHEVROLET	CORVETTE	V-8, 5.7 L	2004	-	1997
-----------	----------	------------	------	---	------

**80232**

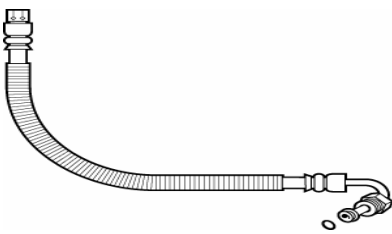

EDH - (28 1/2") - 16mm Hembra "O" Ring x 18mm Macho

CHEVROLET	MALIBU	4 CIL, 2.4 L	1998	-	1997
PONTIAC	GRAND AM	4 CIL, 2.4 L	2001	-	1999

**80233**

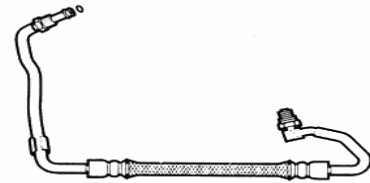

EDH - (29 1/2") - 16mm Hembra "O" Ring x 5/16" Macho "

FORD	CROWN VICTORIA	V-8, 4.6 L	1997	-	1997
MERCURY	GRAND MARQUIS	V-8, 4.6 L	1997	-	1997

**80237**

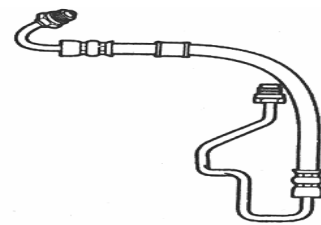

EDH - (41 3/4") - 16mm Macho "O" Ring (Tipo III) x 16mm

FORD	EXPLORER SPORT TRAC	V-6, 4.0 L	2001	-	2001
FORD	EXPLORER	V-6, 4.0 L	2001	-	2000

**80239**

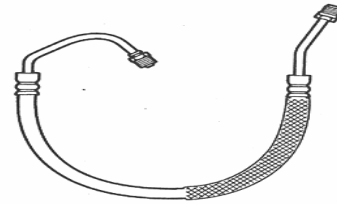

EDH - (37 1/4") - 16mm Macho "O" Ring (Tipo III) x 16mm

FORD	EXPLORER	V-8, 5.0 L	2001	-	2000
------	----------	------------	------	---	------

**80240**

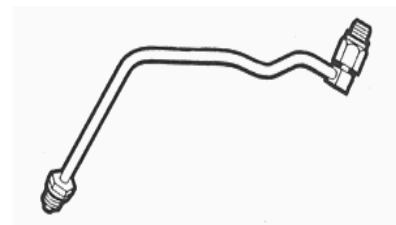

EDH - (13 1/4") - 16mm Macho "O" Ring x 5/16" Macho "C

FORD	MUSTANG	V-8, 4.6 L	1999	-	1999
------	---------	------------	------	---	------

**80251**

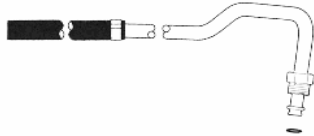

EDH - (22 1/4") - 3/8" Macho "O" Ring

MERCURY	GRAND MARQUIS	V-8, 4.6 L	1999	-	1999
---------	---------------	------------	------	---	------

**80267**



EDH - (45") - 14mm Macho Flare Inv. x 18 mm Macho "O"

HONDA	CIVIC	4 CIL, 1.6 L	2000	-	1998
-------	-------	--------------	------	---	------

**80268**



EDH - (48") - (entrada sensor) 14mm Macho Flare Inv. x 18mm Macho "O"

HONDA	ACCORD	4 CIL, 2.3 L	2000	-	1999
-------	--------	--------------	------	---	------

**80276**



EDH - (32") - 16mm Macho "O" Ring x 18mm Macho "O" F

CHEVROLET	S-10	V-6, 4.3 L	2002	-	1996
CHEVROLET	BLAZER	V-6, 4.3 L	2005	-	1996

**80279**

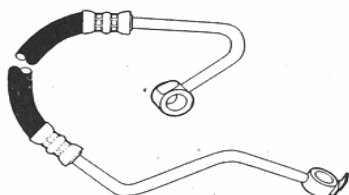

EDH - (38") - 14mm Banjo x 16mm Banjo

CHEVROLET	TRACKER	4 CIL, 2.0 L	2002	-	1999
-----------	---------	--------------	------	---	------

**80286**

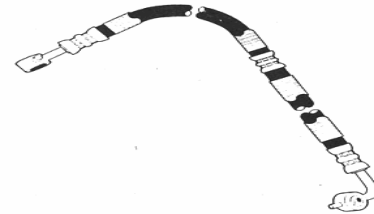

EDH - (24") - 16mm Banjo x 16mm Banjo

NISSAN	ALTIMA	4 CIL, 2.4 L	2001	-	1998
--------	--------	--------------	------	---	------

**80290**

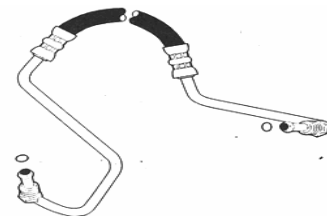

EDH - (37 1/2") - 16mm Macho "O" Ring x 18mm Macho "

JEEP	GRAND CHEROKEE	6 CIL, 4.0 L	2000	-	2000
JEEP	CHEROKEE	6 CIL, 4.0 L	2001	-	1997

**80292**



EDH - (42") - 16mm Macho "O" Ring x 18mm Macho "O" F

JEEP	WRANGLER	4 CIL, 2.5 L	2001	-	1997
------	----------	--------------	------	---	------

**80293**

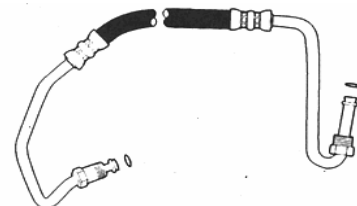

EDH - (44 1/2") - 16mm Macho "O" Ring x 18mm Macho "O" F

JEEP	WRANGLER	6 CIL, 4.0 L	2001	-	2000
------	----------	--------------	------	---	------

80296



EDH - (35 1/2") - 16mm Banjo x 16mm Hembra "O" Ring

CHEVROLET	TRACKER	4 CIL, 1.6 L	1999	-	1999
-----------	---------	--------------	------	---	------

80301



EDH - (30 7/8") - 16mm Hembra "O" Ring x 18mm Macho

PONTIAC	SUNFIRE	4 CIL, 2.2 L	2004	-	2003
PONTIAC	SUNFIRE	4 CIL, 2.4 L	2002	-	2002
CHEVROLET	CAVALIER	4 CIL, 2.2 L	2004	-	2003

80302



EDH - (25 3/8") - 16mm Hembra "O" Ring x 18mm Macho

CHEVROLET	MALIBU	4 CIL, 2.2 L	2006	-	2004
PONTIAC	GRAND AM	4 CIL, 2.2 L	2003	-	2002

80303

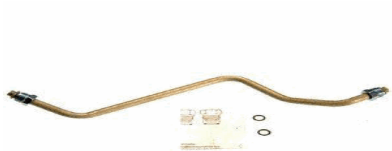

EDH - (15 1/4") - 16mm Macho "O" Ring x 16mm Macho "O" Ring

PONTIAC	GRAND AM	V-6, 3.1 L	1998	-	1998
---------	----------	------------	------	---	------

80306



EDH - (37 1/4") - 16mm Macho "O" Ring x 18mm Macho "O" Ring

DODGE	DURANGO	V-8, 5.9 L	2002	-	1999
DODGE	DURANGO	V-6, 3.9 L	1999	-	1999
DODGE	DURANGO	V-8, 5.2 L	1999	-	1999

80312

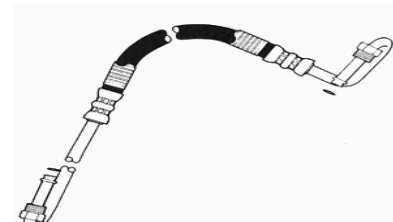

EDH - (44 3/8") - 16mm Macho "O" Ring x 18mm Macho "O" Ring

DODGE	DURANGO	V-8, 5.2 L	2000	-	2000
-------	---------	------------	------	---	------

80321



EDH - (24 3/8") - 16mm "O" Ring Giratorio x 5/16" "O" Ring

FORD	SUPER DUTY PICKUP	V-8, 7.3 L	2000	-	2000
FORD	F-450 SUPER DUTY	V-8, 7.3 L	2003	-	2001

80326

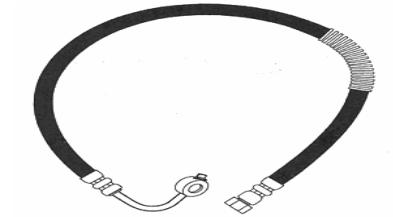

EDH - (42 3/4") - 14mm Hembra Flare Inv. x 16 mm Banjo

DODGE	STRATUS	4 CIL, 2.4 L	2003	-	2003
-------	---------	--------------	------	---	------

80327

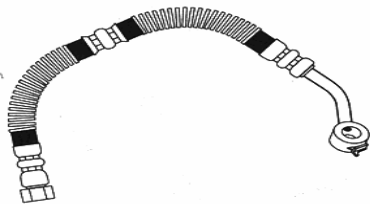

EDH - (18 1/2") - 14mm Hembra Flare Inv. x 16 mm Banj

CHRYSLER	SEBRING	V-6, 3.0 L	2003	-	2001
DODGE	STRATUS	V-6, 3.0 L	2003	-	2001

80332

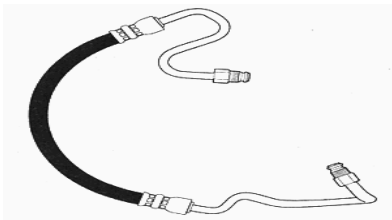

EDH - (39 1/4") - 16mm Macho "O" Ring x 18mm Macho "

CHEVROLET	SILVERADO	V-8, 6.0 L	2007	-	2002
CHEVROLET	SUBURBAN	V-8, 5.3 L	2001	-	2000
CHEVROLET	AVALANCHE	V-8, 5.3 L	2002	-	2002
CHEVROLET	SUBURBAN	V-8, 6.0 L	2001	-	2000

80339

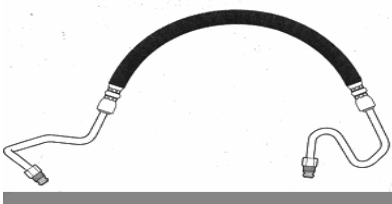

EDH - (39") - 16mm Macho "O" Ring x 18mm Macho "O" F

CHEVROLET	AVALANCHE	V-8, 5.3 L	2003	-	2003
-----------	-----------	------------	------	---	------

80346



EDH - (25 3/4") - 11mm Macho "O" Ring Fijo x 16mm "O"

FORD	RANGER	4 CIL, 2.3 L	2005	-	2002
------	--------	--------------	------	---	------

91723

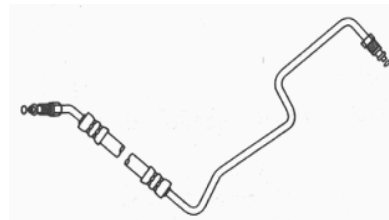

EDH - (43 5/8") - 16mm Macho "O" Ring x 18mm Macho "

PONTIAC	BONNEVILLE	V-6, 3.8 L	1995	-	1994
---------	------------	------------	------	---	------

91755

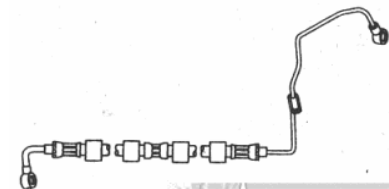

EDH - (48 3/8") - (entrada sensor) 14mm Banjo x 16mm B

NISSAN	300ZX	V-6, 3.0 L	1996	-	1993
--------	-------	------------	------	---	------

91778

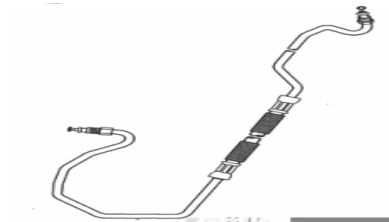

EDH - (65 1/4") - 16mm Macho "O" Ring x 18mm Macho "i

CHEVROLET	CENTURY	V-6, 2.8 L	1996	-	1995
CHEVROLET	CENTURY	V-6, 3.1 L	1996	-	1994

91781

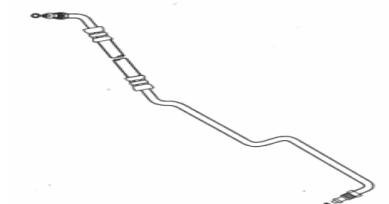

EDH - (41 1/4") - 16mm Macho "O" Ring x 18mm Macho "i

OLDSMOBILE	EIGHTY EIGHT	V-6, 3.8 L	1998	-	1998
PONTIAC	BONNEVILLE	V-6, 3.8 L	1997	-	1996

91804



EDH - (71") - 16mm Macho "O" Ring

PONTIAC	SUNFIRE	4 CIL, 2.2 L	2001	-	1995
---------	---------	--------------	------	---	------

91831

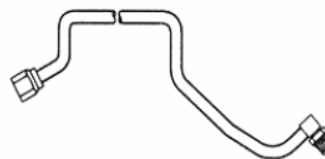

EDH - (26 3/8") - 16mm hembra giratoria x 16mm "O" Ring

LINCOLN	CONTINENTAL	V-8, 4.6 L	2002	-	1995
---------	-------------	------------	------	---	------

91808



EDH - (49 1/2") - 16mm Macho "O" Ring x 18mm Macho "I"

CHEVROLET	LUMINA	V-6, 3.4 L	1998	-	1993
-----------	--------	------------	------	---	------

91835



EDH - (84") - (entrada sensor) 16mm "O" Ring Giratorio x

MERCURY	SABLE	V-6, 3.8 L	1995	-	1994
---------	-------	------------	------	---	------

91817



EDH - (59 1/2") - 16mm Macho "O" Ring x 18mm Macho "I"

CHEVROLET	C y K SERIES PICKUP	V-8, 7.4 L	2000	-	1999
-----------	---------------------	------------	------	---	------

CHEVROLET	C y K SERIES PICKUP	V-8, 8.1 L	2002	-	2001
-----------	---------------------	------------	------	---	------

91836



EDH - (69 1/2") - 16mm "O" Ring giratorio x 16mm "O" R

FORD	THUNDERBIRD	V-8, 4.6 L	1997	-	1994
------	-------------	------------	------	---	------

LINCOLN	MARK VIII	V-8, 4.6 L	1998	-	1994
---------	-----------	------------	------	---	------

91828



EDH - (43") - 16mm hembra giratoria x 16mm "O" Ring gir.

FORD	TOPAZ	4 CIL, 2.3 L	1994	-	1993
------	-------	--------------	------	---	------

FORD	TOPAZ	6 CIL, 3.0 L	1993	-	1993
------	-------	--------------	------	---	------

91837



EDH - (85 3/8") - (entrada sensor) 3/8" Largo "O" Ring Gir

MERCURY	MYSTIQUE	4 CIL, 2.0 L	1997	-	1995
---------	----------	--------------	------	---	------

FORD	CONTOUR	4 CIL, 2.0 L	1997	-	1995
------	---------	--------------	------	---	------



**91838**



EDH - (70 7/8") - (entrada sensor) 3/8" Largo Giratorio "O"

MERCURY	MYSTIQUE	V-6, 2.5 L	1997	-	1995
FORD	CONTOUR	V-6, 2.5 L	1997	-	1995

**91840**



EDH - (62 1/2") - (entrada sensor) 16mm "O" Ring Giratori

FORD	THUNDERBIRD	V-6, 3.8 L	1994	-	1994
------	-------------	------------	------	---	------

**91841**



EDH - (50 3/4") - (entrada sensor) 16mm "O" Ring Giratori

FORD	THUNDERBIRD	V-8, 5.0 L	1993	-	1993
------	-------------	------------	------	---	------

**91842**



EDH - (57 3/4") - (entrada sensor) 16mm "O" Ring Giratori

FORD	THUNDERBIRD	V-8, 5.0 L	1993	-	1993
------	-------------	------------	------	---	------

**91850**



EDH - (81 1/2") - 16mm "O" Ring giratorio x 16mm "O" R

FORD	WINDSTAR	V-6, 3.8 L	1995	-	1995
------	----------	------------	------	---	------

**91851**



EDH - (81 1/2") - 16mm "O" Ring giratorio x 16mm "O" R

FORD	WINDSTAR	V-6, 3.8 L	1995	-	1995
------	----------	------------	------	---	------

**91855**



EDH - (47") - (entrada sensor) 14mm Macho "O" Ring x 1f

NISSAN	240SX	4 CIL, 2.4 L	1998	-	1993
--------	-------	--------------	------	---	------

**91857**



EDH - (71 1/4") - (entrada sensor) 14mm Banjo x 16mm B

NISSAN	PATHFINDER	V-6, 3.0 L	1995	-	1995
NISSAN	PATHFINDER	V-6, 3.5 L	1995	-	1993
NISSAN	PATHFINDER	V-6, 3.3 L	1995	-	1993

**91896**

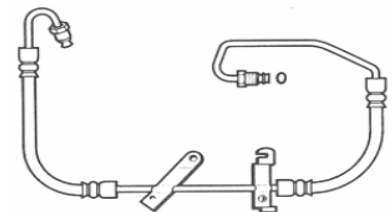

EDH - (56 3/4") - 16mm Macho "O" Ring x 18mm Macho "f"

CHRYSLER	CIRRUS	V-6, 2.5 L	2000	-	1995
JEEP	GRAND CHEROKEE	6 CIL, 4.0 L	1996	-	1994

91933

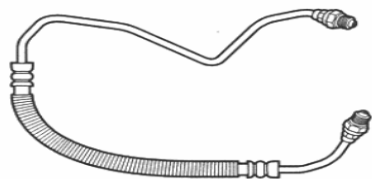

EDH - (38 7/8") - 16mm "O" Ring giratorio x 16mm "O" R

FORD	ESCORT	4 CIL, 1.9 L	1996	-	1994
------	--------	--------------	------	---	------

91934

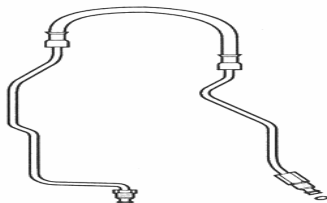

EDH - (46 1/4") - 16mm Macho "O" Ring x 18mm Macho "I"

CHEVROLET	CENTURY	V-6, 3.1 L	1998	-	1997
-----------	---------	------------	------	---	------

91935

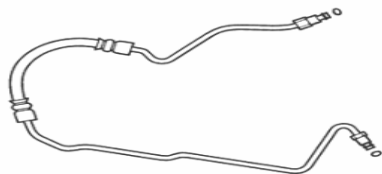

EDH - (46 1/4") - 16mm Macho "O" Ring x 18mm Macho "I"

PONTIAC	GRAND PRIX	V-6, 3.1 L	1998	-	1997
---------	------------	------------	------	---	------

91940

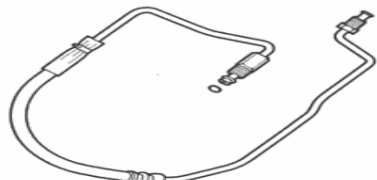

EDH - (59 3/4") - 16mm Macho "O" Ring x 18mm Macho "I"

PONTIAC	GRAND PRIX	V-6, 3.8 L	2003	-	1997
---------	------------	------------	------	---	------

91948

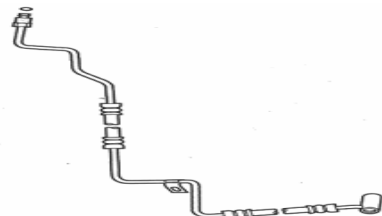

EDH - (62 3/4") - 16mm Banjo x 18mm Macho "O" Ring

DODGE	NEON	4 CIL, 2.0 L	1997	-	1997
-------	------	--------------	------	---	------

91949

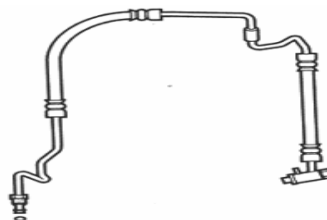

EDH - (65 3/4") - 16mm Banjo x 18mm Macho "O" Ring

DODGE	NEON	4 CIL, 2.0 L	1999	-	1995
-------	------	--------------	------	---	------

91958

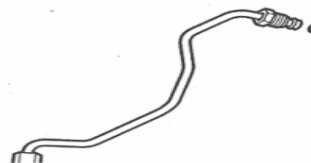

EDH - (19 3/8") - 16mm Macho "O" Ring x 16mm Macho "I"

CHEVROLET	CAVALIER	V-6, 2.8 L	1994	-	1993
-----------	----------	------------	------	---	------

91962

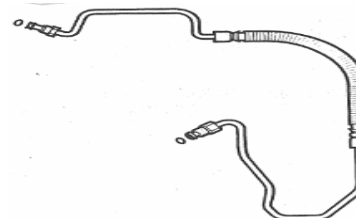

EDH - (65 1/2") - 16mm Macho "O" Ring x 18mm Macho "I"

CHEVROLET	LUMINA	V-6, 3.1 L	1998	-	1998
-----------	--------	------------	------	---	------

91963

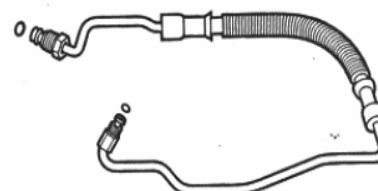

EDH - (49 5/8") - 16mm Macho "O" Ring x 18mm Macho "I"

CHEVROLET	LUMINA	V-6, 3.4 L	1996	-	1996
-----------	--------	------------	------	---	------

91965

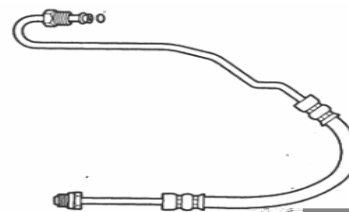

EDH - (40 1/2") - 16mm Macho "O" Ring (Tipo III) x 5/16" I

## Aplicación por Producto

FORD E SERIES VAN V-6, 4.2 L 2002 - 2000

### 91966

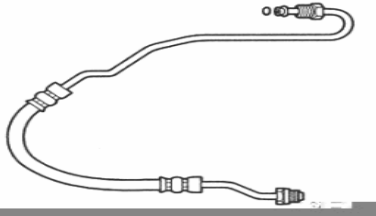

EDH - (39") - 16mm Macho "O" Ring (Tipo III) x 5/16" Macl

FORD	E SERIES VAN	V-8, 5.4 L	2007	-	2001
FORD	E SERIES VAN	V-8, 4.6 L	2006	-	1999
FORD	SUPER DUTY VAN	V-8, 5.4 L	2001	-	2000
FORD	SUPER DUTY VAN	V-10, 6.8 L	2001	-	2000

### 91967



EDH - (45 3/4") - 16mm Macho "O" Ring (Tipo III) x 5/16" Macl

FORD	SUPER DUTY VAN	V-8, 7.3 L	2001	-	2000
------	----------------	------------	------	---	------

### 91968



EDH - (90 1/2") - (entrada sensor) 3/8" giratorio "O" Ring x

MERCURY	MYSTIQUE	4 CIL, 2.0 L	2000	-	1999
FORD	CONTOUR	4 CIL, 2.0 L	1998	-	1998

### 91969

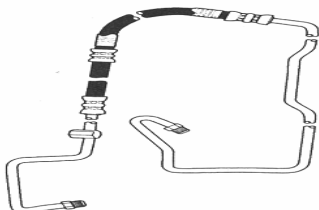

EDH - (76") - (entrada sensor) 3/8" giratorio "O" Ring x 16r

MERCURY	MYSTIQUE	V-6, 2.5 L	2000	-	1998
FORD	CONTOUR	V-6, 2.5 L	2000	-	1998
MERCURY	MYSTIQUE	4 CIL, 2.0 L	1998	-	1998

### 91970

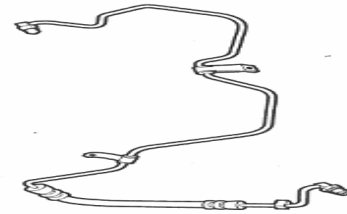

EDH - (74 1/2") - (entrada sensor) 16mm Macho "O" Ring

MERCURY	SABLE	V-6, 3.0 L	2001	-	2001
---------	-------	------------	------	---	------

### 91976

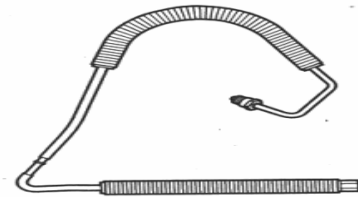

EDH - (54 3/4") - 16mm hembra Inv. Flare x 16mm giratorio

FORD	MUSTANG	V-8, 4.6 L	2000	-	1997
------	---------	------------	------	---	------

### 91978

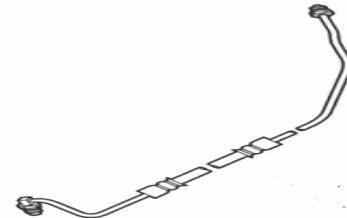

EDH - (37 1/2") - 16mm giratorio "O" Ring x 16mm giratorio

MERCURY	SABLE	V-6, 3.0 L	1998	-	1996
---------	-------	------------	------	---	------

### 91980

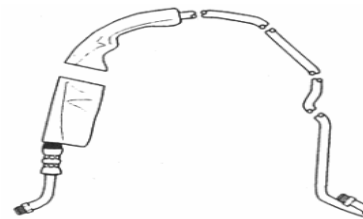

EDH - (62 3/4") - 16mm giratorio "O" Ring x 16mm giratorio

FORD	WINDSTAR	V-6, 3.8 L	1997	-	1996
------	----------	------------	------	---	------

### 91982

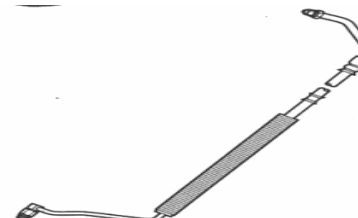

EDH - (50") - 16mm giratorio "O" Ring (Tipo III) x 5/16" giratorio

FORD	MUSTANG	V-6, 3.8 L	1998	-	1998
------	---------	------------	------	---	------

91984



EDH - (39 1/4") - 16mm Macho "O" Ring x 18mm Macho "I"

CHEVROLET	SUBURBAN	V-8, 6.0 L	2002	-	2002
CHEVROLET	SUBURBAN	V-8, 8.1 L	2002	-	2002

91986

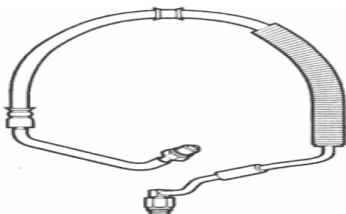

EDH - (49 3/4") - 16mm Macho "O" Ring x 9/16" Macho gir

FORD	MUSTANG	V-8, 4.6 L	2001	-	2001
FORD	MUSTANG	V-6, 3.8 L	2001	-	1999

91998

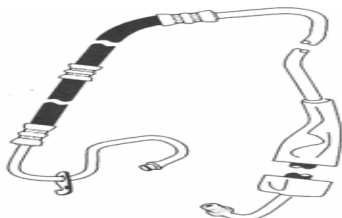

EDH - (69 1/4") - 11mm fijo "O" Ring x 16mm giratorio "O"

FORD	FOCUS	4 CIL, 2.0 L	2000	-	2000
------	-------	--------------	------	---	------

92000

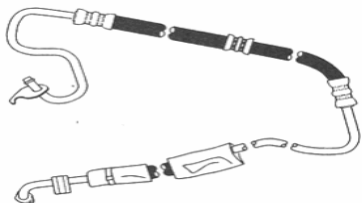

EDH - (65") - (entrada sensor) 11mm Macho fijo "O" Ring :

FORD	FOCUS	4 CIL, 2.0 L	2003	-	2002
------	-------	--------------	------	---	------

92008

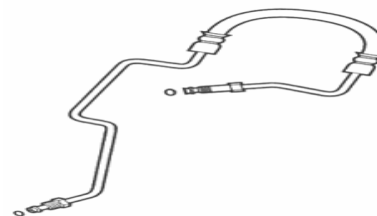

EDH - (47 1/2") - 16mm Macho O-Ring x 18mm Macho O-

FORD	FOCUS	4 CIL, 2.0 L	2001	-	2001
------	-------	--------------	------	---	------

92014

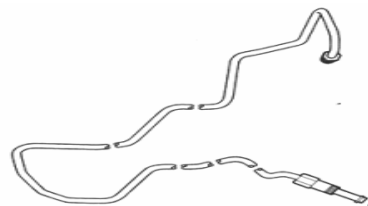

EDH - (61") - 14mm Macho Inv. Flare x 14mm Macho "O" I

NISSAN	QUEST	V-6, 3.3 L	2001	-	1999
NISSAN	QUEST	V-6, 3.0 L	1998	-	1998
NISSAN	QUEST	6 CIL, 3.3 L	2002	-	2002

92018

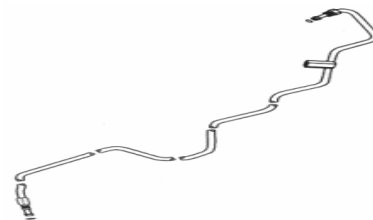

EDH - (61 3/4") - (entrada sensor) 14mm Macho Inv. Flare

NISSAN	QUEST	V-6, 3.0 L	1997	-	1997
--------	-------	------------	------	---	------

92021

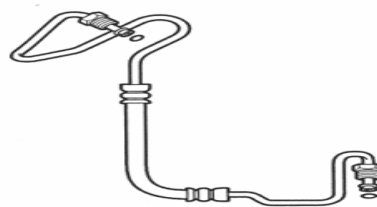

EDH - (44 1/2") - 16mm Macho "O" Ring x 18mm Macho "I"

CHEVROLET	EXPRESS	V-6, 4.3 L	2002	-	2002
CHEVROLET	EXPRESS VAN	V-6, 4.3 L	1999	-	1999

92022

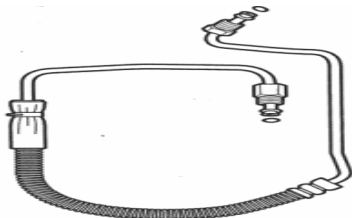

EDH - (61") - 16mm Macho "O" Ring x 18mm Macho "O" F

CHEVROLET	LUMINA	V-6, 3.8 L	1998	-	1998
-----------	--------	------------	------	---	------

92029

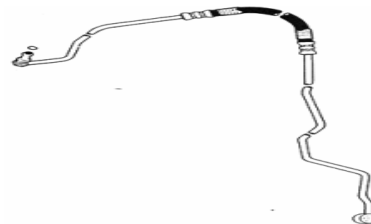

EDH - (67 1/2") - 16mm Banjo x 18mm Macho "O" Ring

VOLKSWAGEN	GOLF	4 CIL, 2.0 L	1999	-	1997
------------	------	--------------	------	---	------

92023

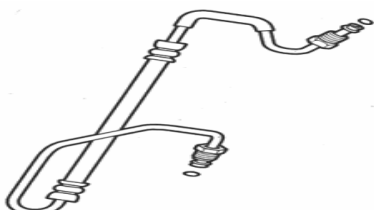

EDH - (45 3/4") - 16mm Macho "O" Ring x 18mm Macho "O" F

JEEP	GRAND CHEROKEE	V-8, 5.2 L	1998	-	1994
JEEP	GRAND CHEROKEE	V-8, 5.9 L	1998	-	1998
JEEP	GRAND CHEROKEE	6 CIL, 4.0 L	1998	-	1996

92030

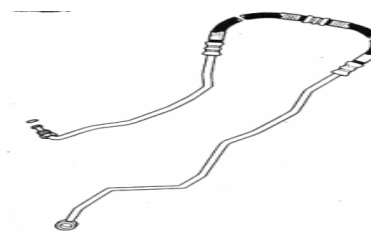

EDH - (69") - 16mm Banjo x 18mm Macho "O" Ring

VOLKSWAGEN	GOLF	4 CIL, 1.8 L	1997	-	1997
VOLKSWAGEN	CABRIO	4 CIL, 2.0 L	1998	-	1995
VOLKSWAGEN	GOLF	4 CIL, 2.0 L	1996	-	1994
VOLKSWAGEN	GTI	4 CIL, 2.0 L	1999	-	1999
VOLKSWAGEN	JETTA	4 CIL, 2.0 L	1999	-	1993

92024

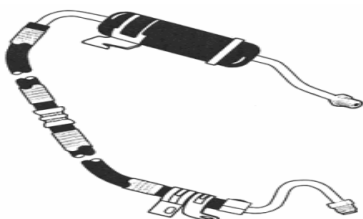

EDH - (43 1/2") - 16mm giratorio "O" Ring x 16mm giratori

MERCURY	SABLE	V-6, 3.0 L	2000	-	1999
---------	-------	------------	------	---	------

92032

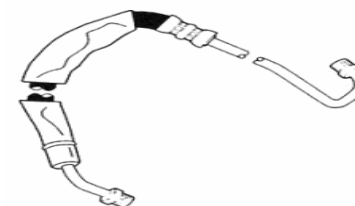

EDH - (59 1/2") - 16mm giratorio "O" Ring x 16mm giratori

FORD	WINDSTAR	V-6, 3.0 L	1998	-	1998
------	----------	------------	------	---	------

92025

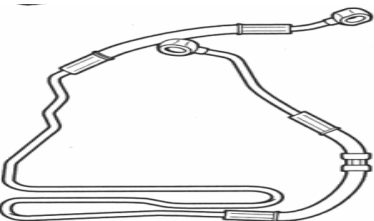

EDH - (86") - 14mm Banjo x 16mm Banjo

VOLKSWAGEN	BEETLE	4 CIL, 2.0 L	2000	-	1998
------------	--------	--------------	------	---	------

92033

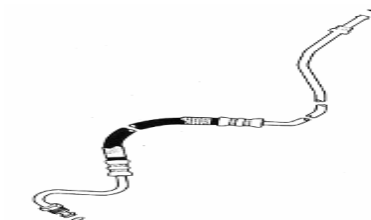

EDH - (46 1/2") - 16mm Macho "O" Ring x 18mm Macho "O" F

CHEVROLET	VENTURE	V-6, 3.4 L	2001	-	2001
-----------	---------	------------	------	---	------



92034

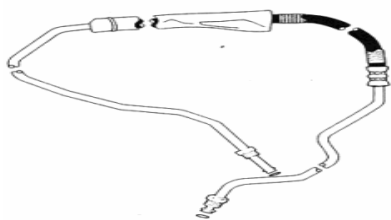

EDH - (62 3/4") - 16mm Macho "O" Ring x 18mm Macho "O"

PONTIAC	AZTEK	V-6, 3.4 L	2005	-	2001
CHEVROLET	VENTURE	V-6, 3.4 L	2002	-	2002

92042

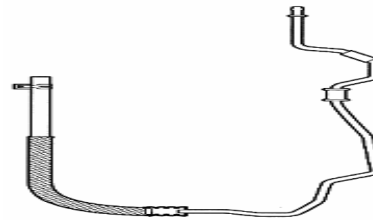

EDH - (59 1/2") - 3/8" tubo doblado x 3/8" I.D. manguera

MERCURY	MYSTIQUE	4 CIL, 2.0 L	2000	-	1998
MERCURY	MYSTIQUE	V-6, 2.5 L	2000	-	1998

92037



EDH - (27 3/4") - 16mm Banjo x 14mm hembra Inv. Flare

NISSAN	MAXIMA	V-6, 3.0 L	2001	-	1999
INFINITI	INFINITI I30	V-6, 3.0 L	2001	-	2001

92043



EDH - (59 3/4") - 16mm giratorio "O" Ring

CHEVROLET	SILVERADO	V-8, 8.1 L	2001	-	2001
-----------	-----------	------------	------	---	------

92039

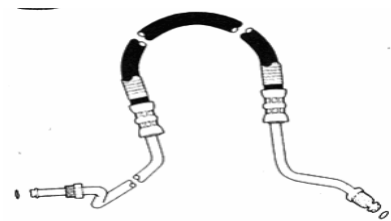

EDH - (56 1/2") - 16mm Macho "O" Ring x 18mm Macho "O"

PONTIAC	GRAND AM	V-6, 3.4 L	2002	-	1999
---------	----------	------------	------	---	------

92048

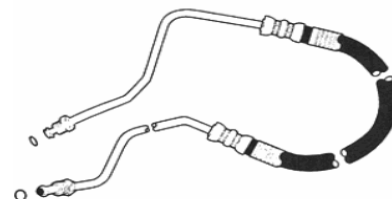

EDH - (45 1/2") - 16mm Macho "O" Ring x 18mm Macho "O"

CHEVROLET	VENTURE	V-6, 3.4 L	1998	-	1998
-----------	---------	------------	------	---	------

92041

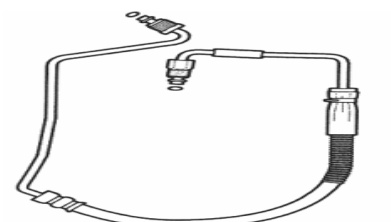

EDH - (62") - 16mm Macho "O" Ring x 18mm Macho "O" F

PONTIAC	GRAND PRIX	V-6, 3.8 L	2002	-	1997
CHEVROLET	IMPALA	V-6, 3.8 L	2005	-	2000
CHEVROLET	MONTE CARLO	V-6, 3.8 L	2005	-	2004

92049

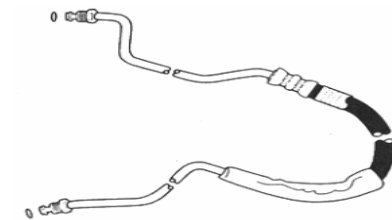

EDH - (43") - 16mm Macho "O" Ring x 18mm Macho "O" F

OLDSMOBILE	SILHOUETTE	V-6, 3.4 L	1996	-	1996
------------	------------	------------	------	---	------

92054

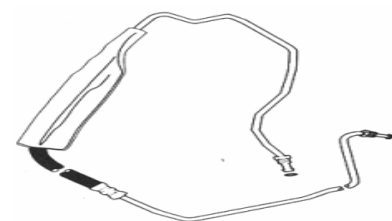

EDH - (72") - 16mm Macho "O" Ring x 18mm Macho "O" F

## Aplicación por Producto

CHEVROLET	IMPALA	V-6, 3.4 L	2004 - 2000
PONTIAC	GRAND PRIX	V-6, 3.1 L	2002 - 1999
CHEVROLET	CENTURY	V-6, 3.1 L	1999 - 1999

**92055**

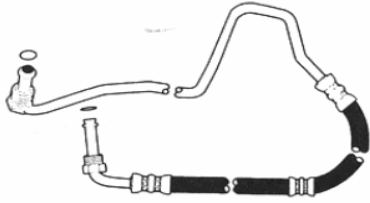

EDH - (43 1/2") - 16mm Macho "O" Ring x 18mm Macho "f"

PONTIAC	BONNEVILLE	V-6, 3.8 L	2005 - 1998
---------	------------	------------	-------------

**92064**

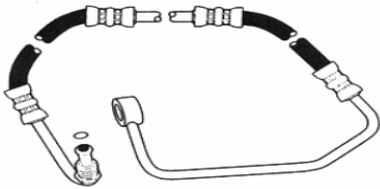

EDH - (57 1/8") - 16mm Banjo x 18mm Macho "O" Ring

DODGE	STRATUS	V-6, 2.5 L	2000 - 1996
-------	---------	------------	-------------

**92070**

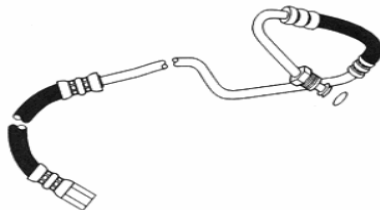

EDH - (51 5/8") - 16mm hembra "O" Ring x 18mm Macho "f"

CHRYSLER	CONCORDE	V-6, 3.2 L	2001 - 1998
CHRYSLER	CONCORDE	V-6, 2.7 L	2000 - 1998
CHRYSLER	300M	V-6, 3.5 L	2003 - 1999
CHRYSLER	CONCORDE	V-6, 3.5 L	2002 - 2002
DODGE	INTREPID	V-6, 3.2 L	2001 - 1998
DODGE	INTREPID	V-6, 3.5 L	2000 - 2000

**92072**

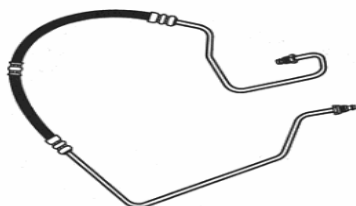

EDH - (66 1/8") - 16mm Macho "O" Ring x 18mm Macho "f"

DODGE	NEON	4 CIL, 2.0 L	2006 - 2000
-------	------	--------------	-------------

**92073**

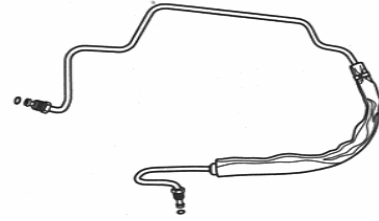

EDH - (53 7/8") - 16mm Macho "O" Ring x 18mm Macho "f"

CHRYSLER	TOWN & COUNTRY	V-6, 3.3 L	2000 - 1999
DODGE	ADVENTURER	V-6, 3.3 L	1999 - 1997
CHRYSLER	GRAND VOYAGER	V-6, 3.3 L	2000 - 1996
CHRYSLER	TOWN & COUNTRY	V-6, 3.8 L	1999 - 1996
CHRYSLER	GRAND VOYAGER	V-6, 3.8 L	2000 - 1996

**92076**

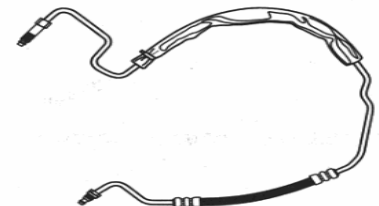

EDH - (58 7/8") - 16mm Macho "O" Ring x 18mm Macho "f"

DODGE	CARAVAN	V-6, 3.3 L	2002 - 2002
DODGE	CARAVAN	V-6, 3.8 L	2002 - 2002
CHRYSLER	TOWN & COUNTRY	V-6, 3.3 L	2002 - 2001
CHRYSLER	TOWN & COUNTRY	V-6, 3.8 L	2002 - 2001

**92078**

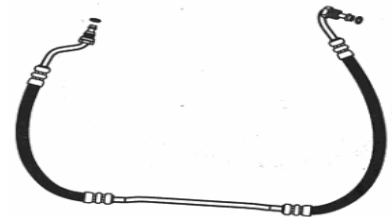

EDH - (53 5/8") - 16mm Macho "O" Ring x 18mm Macho "f"

DODGE	STRATUS	4 CIL, 2.4 L	2004 - 2001
CHRYSLER	SEBRING	4 CIL, 2.4 L	2006 - 2004

**92079**

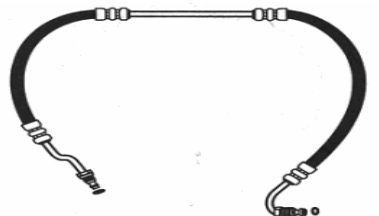

EDH - (49") - 16mm Macho "O" Ring x 18mm Macho "O" F

DODGE	STRATUS	V-6, 2.7 L	2002 - 2001
-------	---------	------------	-------------

92080

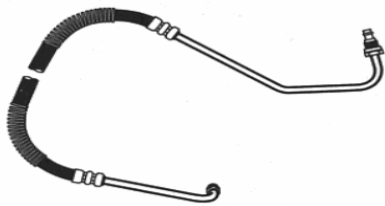

EDH - (61 1/2") - 16mm Macho "O" Ring x 18mm Macho "C"

VOLKSWAGEN	PASSAT	4 CIL, 2.0 L	1993	-	1993
------------	--------	--------------	------	---	------

92081

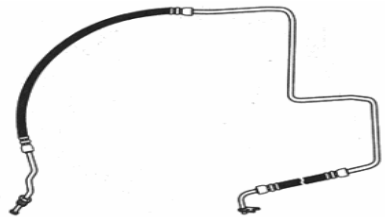

EDH - (82 3/4") - 3/8" Sello fijo x 16mm giratorio "O" Ring

CHEVROLET	TRAILBLAZER	6 CIL, 4.2 L	2007	-	2002
-----------	-------------	--------------	------	---	------

92083



EDH - (55") - 16mm Macho "O" Ring x 18mm Macho "O" F

CHEVROLET	SILVERADO	V-8, 6.6 L	2001	-	2001
-----------	-----------	------------	------	---	------

92090



EDH - (55 3/8") - 16mm Macho "O" Ring x 18mm Macho "C"

CHRYSLER	PT CRUISER	4 CIL, 2.4 L	2002	-	2000
----------	------------	--------------	------	---	------

92091



EDH - (57 1/8") - 16mm Macho "O" Ring x 18mm Macho "C"

CHRYSLER	PT CRUISER	4 CIL, 2.4 L	2007	-	2003
----------	------------	--------------	------	---	------

92092

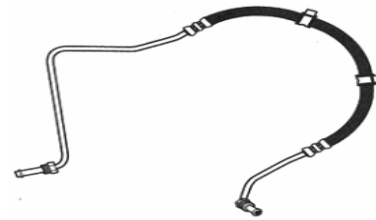

EDH - (52 1/4") - 16mm Macho "O" Ring x 18mm Macho "C"

CHEVROLET	TAHOE	V-8, 5.3 L	2007	-	2006
CHEVROLET	AVALANCHE	V-8, 5.3 L	2006	-	2004
CHEVROLET	SUBURBAN	V-8, 5.3 L	2007	-	2002
CHEVROLET	SONORA	V-8, 5.3 L	2003	-	2003

92100



EDH - (71") - (entrada sensor) 11mm Macho fijo O-Ring x

MERCURY	GRAND MARQUIS	V-8, 4.6 L	2005	-	2004
FORD	CROWN VICTORIA	V-8, 4.6 L	2004	-	2003
LINCOLN	TOWN CAR	V-8, 4.6 L	2006	-	2004

92108



EDH - (44 1/2") - (entrada sensor) 16mm giratorio O-Ring

MERCURY	SABLE	V-6, 3.0 L	2005	-	2002
---------	-------	------------	------	---	------

92110



EDH - (72 5/8") - 16mm Macho O-Ring x 18mm Macho O-

CHRYSLER	PACIFICA	V-6, 3.5 L	2006	-	2006
CHRYSLER	PACIFICA	V-6, 3.8 L	2006	-	2006

92112

CHRYSLER CONCORDE V-6, 3.5 L 1997 - 1997



EDH - (53 5/8") - (entrada sensor) 16mm giratorio O-Ring

FORD WINDSTAR V-6, 3.8 L 2003 - 1999

92113



EDH - (95 1/4") - (entrada sensor) 16mm Macho O-Ring x

LINCOLN LS V-8, 3.9 L 2001 - 2000

92114



EDH - (91 3/8") - (entrada sensor) 16mm Macho O-Ring x

LINCOLN LS V-6, 3.0 L 2001 - 2000

LINCOLN LS V-8, 3.9 L 2002 - 2002

92115



EDH - (64 5/8") - (entrada sensor) 13mm Macho Fijo O-Ri

LINCOLN LS V-8, 3.9 L 2006 - 2003

92121



EDH - (42") - 16mm Macho O-Ring x 3/8" I.D. manguera

## Aplicación por Producto

### Manguera de Enfriamiento

#### 1215T195



1 1/4 - 1 1/2 - 19 1/2 psi: 46

JEEP	CHEROKEE	6 CIL, 4.0 L	1998	-	1998
------	----------	--------------	------	---	------

#### 12T120



NISSAN	SENTRA	4 CIL, 1.6 L	1999	-	1999
--------	--------	--------------	------	---	------

#### 12T150



1 1/4 - 15 psi: 46

DODGE	NEON	4 CIL, 2.0 L	1999	-	1995
VOLKSWAGEN	JETTA	4 CIL, 1.8 L	2000	-	1993
NISSAN	TSURU	4 CIL, 2.0 L	1996	-	1993
FORD	ESCORT	4 CIL, 1.9 L	1996	-	1994
NISSAN	PICK-UP	4 CIL, 2.4 L	1994	-	1993
NISSAN	SENTRA	4 CIL, 1.6 L	1999	-	1999
VOLKSWAGEN	GOLF	4 CIL, 1.8 L	2000	-	1993

#### 12T172



1 1/4 - 17 1/4 psi: 46

VOLKSWAGEN	POINTER PICK-UP	4 CIL, 1.8 L	2001	-	1998
VOLKSWAGEN	POINTER	4 CIL, 1.8 L	2001	-	1998

CHEVROLET	CUTLASS	V-6, 3.1 L	1996	-	1993
VOLKSWAGEN	POINTER STATION WAGON	4 CIL, 1.8 L	2001	-	1998
CHEVROLET	CENTURY	V-6, 3.1 L	1997	-	1993
DODGE	NEON	4 CIL, 2.0 L	1999	-	1995

#### 12T202



1 1/4 - 20 1/4 psi: 46

CHEVROLET	CAVALIER Z24	V-6, 3.1 L	1994	-	1993
CHEVROLET	CAVALIER	V-6, 2.8 L	1994	-	1993
NISSAN	ICHI VAN	4 CIL, 1.8 L	1994	-	1993
CHEVROLET	S-10	4 CIL, 2.2 L	1994	-	1994
VOLKSWAGEN	GOLF	4 CIL, 1.8 L	1994	-	1993
VOLKSWAGEN	JETTA	4 CIL, 1.8 L	1994	-	1993
NISSAN	ESTAQUITAS	4 CIL, 1.8 L	1994	-	1993

#### 12T232



1 1/4 - 23 1/4 psi: 46

VOLKSWAGEN	GOLF	4 CIL, 1.8 L	2000	-	1993
VOLKSWAGEN	JETTA	4 CIL, 1.8 L	2000	-	1993

#### 1517T160



1 1/2 - 1 3/4 - 16 psi: 54

JEEP	CHEROKEE	6 CIL, 4.0 L	1998	-	1998
------	----------	--------------	------	---	------



### 1517T200



1 1/2 - 1 3/4 - 20 psi: 54

FORD	F SERIES PICKUP	V-8, 7.5 L	1997	-	1997
FORD	F-450 SUPER DUTY	V-8, 7.5 L	1997	-	1997
MERCURY	COUGAR XR7	V-6, 3.8 L	1994	-	1993

### 1517T225



1 1/2 - 1 3/4 - 22 1/2 psi: 54

MERCURY	GHIA	V-6, 3.0 L	1994	-	1993
CHEVROLET	CUTLASS	V-6, 3.1 L	1996	-	1993
CHEVROLET	CENTURY	V-6, 3.1 L	1997	-	1993

### 15T185



1 1/2 - 18 1/2 psi: 54

FORD	EXPLORER	V-6, 4.0 L	2001	-	1999
------	----------	------------	------	---	------

### 15T222



1 1/2 - 22 1/4 psi: 54

FORD	F SERIES PICKUP	V-8, 5.8 L	1998	-	1995
DODGE	D-250	V-8, 5.9 L	1993	-	1993

### 15T350



1 1/2 - 35 psi: 54

FORD	F-150	V-6, 4.9 L	1997	-	1995
FORD	F SERIES PICKUP	V-6, 4.9 L	1997	-	1995

### 17T135 GS



DODGE	D-250	V-8, 5.9 L	1993	-	1993
-------	-------	------------	------	---	------

### 17T235



1 1/4 - 23 1/2 psi: 63

MERCURY	GHIA	V-6, 3.0 L	1994	-	1993
---------	------	------------	------	---	------

### 18010



HONDA	ACCORD	V-6, 3.0 L	2002	-	2002
-------	--------	------------	------	---	------

### 18011



## Aplicación por Producto

CHEVROLET	TRACKER	V-6, 2.5 L	2002	-	2002
-----------	---------	------------	------	---	------

**18122**

**18020**



CHEVROLET	MONTE CARLO	V-6, 3.4 L	2005	-	2004
PONTIAC	AZTEK	V-6, 3.4 L	2004	-	2002
CHEVROLET	MALIBU	V-6, 3.1 L	2003	-	2002
CHEVROLET	VENTURE	V-6, 3.4 L	2004	-	2002
CHEVROLET	IMPALA	V-6, 3.4 L	2004	-	2003
PONTIAC	GRAND AM	V-6, 3.4 L	2004	-	2002

**18031**



MERCURY	SABLE / TAURUS	V-6, 3.0 L	2002	-	2002
---------	----------------	------------	------	---	------

**18070**



MERCURY	GRAND MARQUIS	V-8, 4.6 L	2002	-	1999
LINCOLN	TOWN CAR	V-8, 4.6 L	2002	-	1999
FORD	CROWN VICTORIA	V-8, 4.6 L	1999	-	1999

**18079**



CHEVROLET	S-10	4 CIL, 2.2 L	2003	-	1999
-----------	------	--------------	------	---	------

CHEVROLET	SILVERADO	V-8, 4.8 L	2007	-	2001
CADILLAC	ESCALADE	V-8, 6.0 L	2002	-	2002
CHEVROLET	SILVERADO	V-8, 5.3 L	2007	-	2000
CHEVROLET	SUBURBAN	V-8, 6.0 L	2002	-	2000
CHEVROLET	SUBURBAN	V-8, 5.3 L	2002	-	2000
CHEVROLET	SILVERADO	V-8, 6.0 L	2007	-	2000
CADILLAC	ESCALADE	V-8, 5.3 L	2002	-	2002
CHEVROLET	AVALANCHE	V-8, 5.3 L	2002	-	2002

**18124**



DODGE	RAM SERIES PICKUP	6 CIL, 5.9 L Diesel	2002	-	1999
-------	-------------------	---------------------	------	---	------

**18125**



PONTIAC	FIREBIRD TRANS AM	V-8, 5.7 L	2002	-	1999
CHEVROLET	CAMARO Z28	V-8, 5.7 L	2002	-	1998
CHEVROLET	CORVETTE	V-8, 5.7 L	2000	-	1997

**18126**



CADILLAC	ESCALADE	V-8, 5.3 L	2004	-	2004
CADILLAC	ESCALADE	V-8, 6.0 L	2004	-	2004

## Aplicación por Producto

CHEVROLET	SUBURBAN	V-8, 5.3 L	2004 - 2004
CHEVROLET	AVALANCHE	V-8, 5.3 L	2004 - 2004

**18127**



**18219**



HONDA	ACCORD	V-6, 3.0 L	2002 - 2002
-------	--------	------------	-------------

**18225**

CHEVROLET	CORVETTE	V-8, 5.7 L	2004 - 2002
-----------	----------	------------	-------------

**18129**



FORD	WINDSTAR	V-6, 3.8 L	2003 - 2002
------	----------	------------	-------------

**18227**

CHEVROLET	EXPRESS	V-8, 6.0 L	2007 - 2004
CHEVROLET	EXPRESS	V-8, 5.3 L	2007 - 2004

**18201**



HONDA	ACCORD	V-6, 3.0 L	2002 - 2002
-------	--------	------------	-------------

**18230**

TOYOTA	LAND CRUISER	V-8, 4.7 L	2007 - 2004
--------	--------------	------------	-------------

**18202**



CADILLAC	DEVILLE	V-8, 4.6 L	2003 - 2002
----------	---------	------------	-------------

**18242**

CHEVROLET	TRACKER	4 CIL, 2.0 L	2003 - 2002
-----------	---------	--------------	-------------



PONTIAC	SUNFIRE	4 CIL, 2.4 L	2002 - 2000
---------	---------	--------------	-------------

## Aplicación por Producto

**18246**

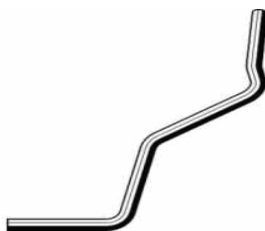

FORD WINDSTAR V-6, 3.8 L 2003 - 2002

**18250**



PONTIAC AZTEK V-6, 3.4 L 2004 - 2004

**18254**



CHEVROLET CAMARO Z28 V-8, 5.7 L 2002 - 2000

**18259**



TOYOTA 4 RUNNER V-8, 4.7 L 2004 - 2004

**18261**



FORD FOCUS 4 CIL, 2.0 L 2002 - 2002

**18275**



MERCEDES BE CLK320 V-6, 3.2 L 2005 - 1999

**18314**



CHRYSLER CONCORDE V-6, 3.5 L 2002 - 2002

DODGE INTREPID V-6, 3.5 L 2002 - 2002

CHRYSLER 300M V-6, 3.5 L 2002 - 2002

**18321**



FORD FOCUS 4 CIL, 2.0 L 2002 - 2002

**18322**



FORD FOCUS 4 CIL, 2.0 L 2002 - 2002

18324



CADILLAC	DEVILLE	V-8, 4.6 L	2003	-	2003
----------	---------	------------	------	---	------

18422



CHEVROLET	TRACKER	V-6, 2.5 L	2002	-	2002
-----------	---------	------------	------	---	------

18429



CHEVROLET	TRACKER	4 CIL, 2.0 L	2003	-	1999
-----------	---------	--------------	------	---	------

18446



PONTIAC	GRAND PRIX	V-6, 3.1 L	1999	-	1999
---------	------------	------------	------	---	------

18447



CHEVROLET	CORVETTE	V-8, 5.7 L	2004	-	2002
-----------	----------	------------	------	---	------

18449



CHRYSLER	CIRRUS	4 CIL, 2.4 L	2000	-	2000
DODGE	STRATUS	4 CIL, 2.4 L	2000	-	1999

18453



CHEVROLET	TRAILBLAZER	6 CIL, 4.2 L	2004	-	2004
-----------	-------------	--------------	------	---	------

18460



NISSAN	FRONTIER	V-6, 3.3 L	2002	-	2002
NISSAN	XTERRA	V-6, 3.3 L	2002	-	2002

18461



NISSAN	XTERRA	V-6, 3.3 L	2002	-	2002
NISSAN	FRONTIER	V-6, 3.3 L	2002	-	2002



## Aplicación por Producto

**18462**



NISSAN	FRONTIER	V-6, 3.3 L	2002	-	2002
NISSAN	XTERRA	V-6, 3.3 L	2002	-	2002

**18463**



CHEVROLET	TRACKER	4 CIL, 2.0 L	2003	-	2003
-----------	---------	--------------	------	---	------

**18700**



HONDA	CR-V	4 CIL, 2.0 L	2001	-	1999
-------	------	--------------	------	---	------

**18701**



HONDA	CR-V	4 CIL, 2.0 L	2001	-	1999
-------	------	--------------	------	---	------

**18710**



DODGE	RAM 4000	V-6, 6.7 L DIESEL	2008	-	2009
-------	----------	-------------------	------	---	------

**18718**



CADILLAC	CTS	V-6, 3.2 L	2003	-	2003
----------	-----	------------	------	---	------

**18748**



HONDA	CIVIC	4 CIL, 1.6 L	2000	-	1999
-------	-------	--------------	------	---	------

**18749**



CHEVROLET	VENTURE	V-6, 3.4 L	2000	-	1999
-----------	---------	------------	------	---	------

**18769**



SUZUKI	GRAND VITARA	4 CIL, 2.4 L	2009	-	2010
--------	--------------	--------------	------	---	------

**18774**



DODGE	RAM 4000	V-6, 6.7 L DIESEL	2008	-	2009
-------	----------	-------------------	------	---	------

**18797**



CHEVROLET	TRAILBLAZER	6 CIL, 4.2 L	2004	-	2002
-----------	-------------	--------------	------	---	------

**18782**



TOYOTA	COROLLA	4 CIL, 1.8 L	2002	-	2002
CADILLAC	DEVILLE	V-8, 4.6 L	2003	-	2003

**18802**



HONDA	CR-V	4 CIL, 2.0 L	2001	-	1999
-------	------	--------------	------	---	------

**18787**



LINCOLN	LS	V-8, 3.9 L	2002	-	2000
JAGUAR	S-TYPE	V-8, 4.0 L	2005	-	2000

**18813**



FORD	MUSTANG	V-6, 3.8 L	1999	-	1996
------	---------	------------	------	---	------

**18792**



HONDA	CIVIC	4 CIL, 1.6 L	2000	-	1999
-------	-------	--------------	------	---	------

**18831**



MERCURY	SABLE / TAURUS	V-6, 3.0 L	2002	-	2002
---------	----------------	------------	------	---	------

**18846**



CHEVROLET	TRAILBLAZER	6 CIL, 4.2 L	2004	-	2004
-----------	-------------	--------------	------	---	------

## Aplicación por Producto

**18849**



MITSUBISHI	ECLIPSE	V-6, 3.8 L	2007 - 2006
------------	---------	------------	-------------

**18856**



CHEVROLET	TRAILBLAZER	6 CIL, 4.2 L	2004 - 2004
-----------	-------------	--------------	-------------

**18868**



MITSUBISHI	ECLIPSE	V-6, 3.8 L	2007 - 2006
------------	---------	------------	-------------

**18873**



CHRYSLER	VOYAGER	V-6, 3.8 L	1999 - 1999
CHEVROLET	CAMARO Z28	V-6, 3.8 L	2002 - 1999
CHRYSLER	GRAND VOYAGER	V-6, 3.8 L	2000 - 2000
CHRYSLER	VOYAGER	V-6, 3.3 L	1999 - 1999
CHRYSLER	TOWN & COUNTRY	V-6, 3.8 L	2000 - 1999

**18882**



DODGE	STRATUS	4 CIL, 2.0 L	2000 - 1999
CHRYSLER	CIRRUS	4 CIL, 2.0 L	2000 - 2000

**18908**



CHEVROLET	CAMARO Z28	V-8, 5.7 L	2002 - 2000
PONTIAC	FIREBIRD TRANS AM	V-8, 5.7 L	2002 - 2001

**18914**



HUMMER	H2	V-8, 6.0 L	2007 - 2005
CHEVROLET	AVALANCHE	V-8, 5.3 L	2004 - 2002
CHEVROLET	SILVERADO	V-8, 4.8 L	2007 - 2001
CHEVROLET	SILVERADO	V-8, 5.3 L	2007 - 2000
CHEVROLET	SILVERADO	V-8, 6.0 L	2007 - 2000
CHEVROLET	SUBURBAN	V-8, 5.3 L	2004 - 2002
CHEVROLET	SUBURBAN	V-8, 6.0 L	2002 - 2002
CADILLAC	ESCALADE	V-8, 5.3 L	2004 - 2004
CADILLAC	ESCALADE	V-8, 6.0 L	2004 - 2004

**18916**



FORD	RANGER	4 CIL, 2.5 L	2001 - 2000
------	--------	--------------	-------------

## Aplicación por Producto

FORD	WINDSTAR	V-6, 3.8 L	2003	-	2002
------	----------	------------	------	---	------

**18948**

**18922**



JEEP	GRAND CHEROKEE	V-8, 4.7 L	2003	-	1999
------	----------------	------------	------	---	------

**18930**



BMW	540I	V-8, 4.4 L	2001	-	1999
BMW	740IL	V-8, 4.4 L	2001	-	1999
BMW	740I	V-8, 4.4 L	2001	-	1999

**18933**



CORTAR A MEDIDA

CHEVROLET	EXPRESS	V-8, 5.3 L	2007	-	2007
CHEVROLET	EXPRESS	V-8, 6.0 L	2006	-	2004
CHEVROLET	EXPRESS	V-8, 5.3 L	2006	-	2005
CHEVROLET	EXPRESS	V-8, 5.3 L	2004	-	2004
CHEVROLET	EXPRESS	V-8, 6.0 L	2007	-	2007

**18937**



SUZUKI	GRAND VITARA	V-6, 3.2 L	2009	-	2010
--------	--------------	------------	------	---	------



CHRYSLER	VOYAGER	V-6, 3.8 L	1999	-	1999
CHRYSLER	TOWN & COUNTRY	V-6, 3.8 L	2000	-	1999
CHRYSLER	VOYAGER	V-6, 3.3 L	1999	-	1999
CHRYSLER	GRAND VOYAGER	V-6, 3.8 L	2000	-	2000

**18951**



FORD	ZX2	4 CIL, 2.0 L	2002	-	2001
FORD	ESCORT	4 CIL, 2.0 L	2000	-	1999

**18952**



CHEVROLET	TRAILBLAZER	6 CIL, 4.2 L	2004	-	2004
-----------	-------------	--------------	------	---	------

**18959**



CHEVROLET	CAMARO Z28	V-8, 5.7 L	2000	-	1998
-----------	------------	------------	------	---	------

18970



NISSAN	ALTIMA	4 CIL, 2.4 L	2001 - 1999
--------	--------	--------------	-------------

19000



LINCOLN	CONTINENTAL	V-8, 4.6 L	2002 - 1997
---------	-------------	------------	-------------

19004



JEEP	WRANGLER	4 CIL, 2.5 L	2000 - 1999
------	----------	--------------	-------------

19005



DODGE	CARAVAN	V-6, 3.3 L FLEX	2003 - 2001
CHRYSLER	TOWN & COUNTRY	V-6, 3.8 L	2003 - 2002
CHRYSLER	VOYAGER	V-6, 3.3 L	2002 - 2002
DODGE	CARAVAN	V-6, 3.3 L	2007 - 2004

19022



CHEVROLET	VENTURE	V-6, 3.4 L	2000 - 1999
-----------	---------	------------	-------------

19025



CHEVROLET	CHEYENNE	V-8, 5.7 L	2000 - 1998
CHEVROLET	C-3500	V-8, 5.7 L	2000 - 1994
CHEVROLET	C-2500	V-8, 5.7 L	2000 - 1996
FORD	F-150	V-6, 4.2 L	2007 - 2002
CHEVROLET	C-1500	V-8, 5.7 L	2000 - 1999
CHEVROLET	400SS	V-8, 5.7 L	2000 - 1999
CHEVROLET	C y K SERIES PICKUP	V-8, 5.7 L	2000 - 1994
CHEVROLET	C y K SERIES PICKUP	V-8, 5.0 L	1999 - 1999
CADILLAC	ESCALADE	V-8, 5.7 L	2000 - 1999
CHEVROLET	C y K SERIES PICKUP	V-6, 4.3 L	1998 - 1996
FORD	SUPER DUTY VAN	V-6, 4.2 L	2001 - 2001
CHEVROLET	BLAZER	V-6, 4.3 L	2005 - 1996
FORD	F SERIES PICKUP	V-6, 4.2 L	2002 - 1999
CHEVROLET	C-1500	V-6, 4.3 L	1998 - 1996
CHEVROLET	EXPRESS CARGO VAN	V-8, 5.7 L	2000 - 1999
CHEVROLET	EXPRESS	V-6, 4.3 L	2003 - 1999
CHRYSLER	GRAND VOYAGER	V-6, 3.8 L	2000 - 2000
CHEVROLET	SUBURBAN	V-8, 5.7 L	1999 - 1998
CHEVROLET	S-10	V-6, 4.3 L	2002 - 1996
CHEVROLET	EXPRESS VAN PASAJEROS	V-6, 4.3 L	2000 - 1998
CHEVROLET	EXPRESS VAN PASAJEROS	V-8, 5.7 L	2000 - 1998
CHEVROLET	EXPRESS CARGO VAN	V-6, 4.3 L	2007 - 2010
CHEVROLET	EXPRESS	V-8, 5.7 L	2002 - 1999
CHRYSLER	VOYAGER	V-6, 3.3 L	1999 - 1999
CHEVROLET	EXPRESS	V-8, 5.0 L	2002 - 1999
CHRYSLER	TOWN & COUNTRY	V-6, 3.8 L	2000 - 1999
FORD	E SERIES VAN	V-6, 4.2 L	2003 - 1999
CHRYSLER	VOYAGER	V-6, 3.8 L	1999 - 1999
CHEVROLET	SILVERADO	V-6, 4.3 L	2007 - 2010



19026



PONTIAC	AZTEK	V-6, 3.4 L	2005	-	2001
PONTIAC	GRAND AM	V-6, 3.1 L	1998	-	1997
CHEVROLET	IMPALA	V-6, 3.4 L	2005	-	2000
PONTIAC	MONTANA	V-6, 3.5 L	2006	-	2006
CHEVROLET	MALIBU	V-6, 3.5 L	2004	-	2004
CHEVROLET	VENTURE	V-6, 3.4 L	2005	-	1997
CHEVROLET	LUMINA	V-6, 3.1 L	1998	-	1998
PONTIAC	TORRENT	V-6, 3.4 L	2008	-	2006
PONTIAC	G6	V-6, 3.5 L	2006	-	2006
CHEVROLET	MALIBU	V-6, 3.1 L	2003	-	1998
PONTIAC	GRAND PRIX	V-6, 3.1 L	2002	-	1999
PONTIAC	GRAND AM	V-6, 3.4 L	2005	-	1999
CHEVROLET	MONTE CARLO	V-6, 3.4 L	2005	-	2004

19030



JAGUAR	S-TYPE	V-8, 4.0 L	2005	-	2000
LINCOLN	LS	V-8, 3.9 L	2002	-	2000

19035



JEEP	GRAND CHEROKEE	V-8, 4.7 L	2003	-	1999
CADILLAC	DEVILLE	V-8, 4.6 L	2003	-	2002

19037



JEEP	WRANGLER	4 CIL, 2.5 L	2000	-	1999
------	----------	--------------	------	---	------

19038



JEEP	CHEROKEE	6 CIL, 4.0 L	2001	-	1999
------	----------	--------------	------	---	------

19039



JEEP	CHEROKEE	6 CIL, 4.0 L	2001	-	1999
JEEP	WRANGLER	6 CIL, 4.0 L	2006	-	2005

19041



TOYOTA	COROLLA	4 CIL, 1.8 L	2002	-	2002
--------	---------	--------------	------	---	------

19042



## Aplicación por Producto

HONDA	CIVIC	4 CIL, 1.6 L	2000	-	1999
-------	-------	--------------	------	---	------

**19044**



HONDA	ACCORD	4 CIL, 2.3 L	2002	-	2002
-------	--------	--------------	------	---	------

**19045**



HONDA	ACCORD	4 CIL, 2.3 L	2002	-	1999
-------	--------	--------------	------	---	------

**19048**



PONTIAC	GRAND AM	V-6, 3.4 L	2004	-	1999
---------	----------	------------	------	---	------

CHEVROLET	MALIBU	V-6, 3.1 L	2003	-	1999
-----------	--------	------------	------	---	------

**19049**



CHEVROLET	MALIBU	V-6, 3.1 L	2003	-	1999
-----------	--------	------------	------	---	------

PONTIAC	GRAND AM	V-6, 3.4 L	2004	-	1999
---------	----------	------------	------	---	------

**19054**



PONTIAC	GRAND PRIX	V-6, 3.1 L	1999	-	1999
---------	------------	------------	------	---	------

**19056**



FORD	MUSTANG	V-8, 4.6 L	2001	-	1999
------	---------	------------	------	---	------

**19058**



FORD	ZX2	4 CIL, 2.0 L	2002	-	2001
------	-----	--------------	------	---	------

FORD	ESCORT	4 CIL, 2.0 L	2000	-	1999
------	--------	--------------	------	---	------

**19060**



FORD	CONTOUR	4 CIL, 2.0 L	2000	-	1999
------	---------	--------------	------	---	------

MERCURY	MYSTIQUE	4 CIL, 2.0 L	2000	-	1999
---------	----------	--------------	------	---	------

## Aplicación por Producto

**19062**



FORD	MUSTANG	V-8, 4.6 L	1999	-	1999
------	---------	------------	------	---	------

**19068**



VOLKSWAGEN	BEETLE	4 CIL, 2.0 L	2002	-	1999
------------	--------	--------------	------	---	------

**19070**



CHEVROLET	S-10	V-6, 4.3 L	2002	-	1999
-----------	------	------------	------	---	------

CHEVROLET	BLAZER	V-6, 4.3 L	2005	-	1999
-----------	--------	------------	------	---	------

**19077**



VOLKSWAGEN	BEETLE	4 CIL, 2.0 L	2002	-	1999
------------	--------	--------------	------	---	------

**19082**



CHEVROLET	EXPRESS	V-8, 6.0 L	2007	-	2007
CHEVROLET	EXPRESS	V-8, 5.3 L	2004	-	2004
CHRYSLER	CIRRUS	4 CIL, 2.4 L	2000	-	2000
CHEVROLET	EXPRESS	V-8, 5.3 L	2007	-	2007
CHEVROLET	EXPRESS	V-8, 6.0 L	2004	-	2004
DODGE	STRATUS	4 CIL, 2.4 L	2000	-	1999
CHEVROLET	EXPRESS	V-8, 6.0 L	2006	-	2005

**19087**



CADILLAC	SEVILLE	V-8, 4.6 L	2003	-	1999
CADILLAC	EL DORADO	V-8, 4.6 L	1999	-	1999
CADILLAC	DEVILLE	V-8, 4.6 L	1999	-	1999
CHRYSLER	PACIFICA	V-6, 3.5 L	2006	-	2006

**19088**



CADILLAC	EL DORADO	V-8, 4.6 L	1999	-	1999
----------	-----------	------------	------	---	------

CADILLAC	DEVILLE	V-8, 4.6 L	1999	-	1999
----------	---------	------------	------	---	------

CADILLAC	SEVILLE	V-8, 4.6 L	2003	-	1999
----------	---------	------------	------	---	------

**19089**



DODGE	STRATUS	V-6, 2.5 L	2000	-	1999
-------	---------	------------	------	---	------

CHRYSLER	CIRRUS	V-6, 2.5 L	2000	-	1999
----------	--------	------------	------	---	------

## Aplicación por Producto

**19090**



CHRYSLER	CIRRUS	V-6, 2.5 L	2000	-	1999
DODGE	STRATUS	V-6, 2.5 L	2000	-	1999

**19092**



TOYOTA	CAMRY	V-6, 3.0 L	2002	-	2002
--------	-------	------------	------	---	------

**19093**



TOYOTA	CAMRY	V-6, 3.0 L	2002	-	2002
--------	-------	------------	------	---	------

**19102**



JEEP	GRAND CHEROKEE	V-8, 4.7 L	2003	-	1999
------	----------------	------------	------	---	------

**19103**



FORD	WINDSTAR	V-6, 3.8 L	2003	-	2002
------	----------	------------	------	---	------

**19105**

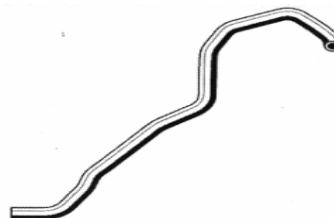

FORD	CONTOUR	V-6, 2.5 L	2000	-	1999
MERCURY	MYSTIQUE	V-6, 2.5 L	2000	-	1999

**19106**



FORD	MUSTANG	V-6, 3.8 L	2000	-	1999
------	---------	------------	------	---	------

**19114**



FORD	F SERIES PICKUP	V-6, 4.2 L	2002	-	1999
FORD	F-150	V-6, 4.2 L	2007	-	2002

**19115**

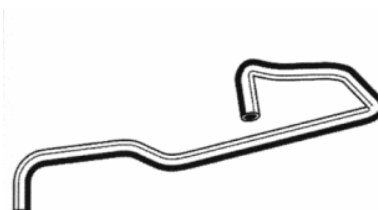

FORD	E SERIES VAN	V-6, 4.2 L	2000	-	1999
------	--------------	------------	------	---	------

19120



PONTIAC	GRAND PRIX	V-6, 3.8 L	2002 - 1999
CHEVROLET	IMPALA	V-6, 3.8 L	2003 - 2000

19121



PONTIAC	GRAND PRIX	V-6, 3.8 L	2002 - 1999
CHEVROLET	IMPALA	V-6, 3.8 L	2003 - 2000

19126



CORTAR A MEDIDA

JEEP	WRANGLER	6 CIL, 4.0 L	2006 - 2005
------	----------	--------------	-------------

19130



TOYOTA	4 RUNNER	V-6, 3.4 L	2002 - 2002
--------	----------	------------	-------------

19140



FORD	RANGER	4 CIL, 2.3 L	2002 - 2001
------	--------	--------------	-------------

19152



FORD	MUSTANG	V-6, 3.8 L	2001 - 1999
------	---------	------------	-------------

19153



FORD	FOCUS	4 CIL, 2.0 L	2004 - 2002
------	-------	--------------	-------------

19154



FORD	FOCUS	4 CIL, 2.0 L	2004 - 2000
------	-------	--------------	-------------

19155



FORD	FOCUS	4 CIL, 2.0 L	2002 - 2002
------	-------	--------------	-------------



**19156**



JEEP	GRAND CHEROKEE	V-8, 4.7 L	2003	-	1999
FORD	FOCUS	4 CIL, 2.0 L	2002	-	2002

**19174**



HONDA	ODYSSEY	V-6, 3.5 L	2002	-	1999
-------	---------	------------	------	---	------

**19175**

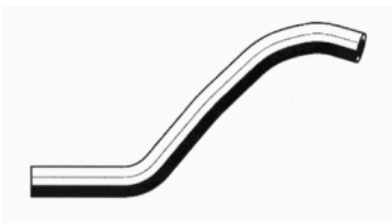

CHEVROLET	VENTURE	V-6, 3.4 L	2004	-	2003
-----------	---------	------------	------	---	------

**19176**



HONDA	CR-V	4 CIL, 2.0 L	2001	-	1999
-------	------	--------------	------	---	------

**19178**

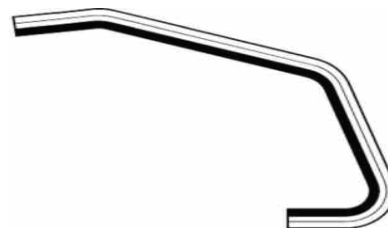

HONDA	ODYSSEY	V-6, 3.5 L	2002	-	2002
-------	---------	------------	------	---	------

**19183**



FORD	EXPLORER	V-8, 5.0 L	2001	-	1999
------	----------	------------	------	---	------

**19186**



NISSAN	SENTRA	4 CIL, 2.0 L	1999	-	1999
--------	--------	--------------	------	---	------

**19187**



NISSAN	SENTRA	4 CIL, 1.6 L	1999	-	1999
--------	--------	--------------	------	---	------

**19188**



NISSAN	SENTRA	4 CIL, 1.6 L	1999	-	1996
--------	--------	--------------	------	---	------

## Aplicación por Producto

**19191**



FORD	SUPER DUTY VAN	V-8, 5.4 L	2002 - 2000
FORD	SUPER DUTY VAN	V-10, 6.8 L	2002 - 1999
FORD	E SERIES VAN	V-8, 5.4 L	2002 - 1999

**19192**



FORD	E SERIES VAN	V-8, 5.4 L	1999 - 1999
------	--------------	------------	-------------

**19193**



FORD	LOBO	V-8, 5.4 L	2002 - 2002
FORD	F SERIES PICKUP	V-8, 4.6 L	2001 - 1999
FORD	EXPEDITION	V-8, 4.6 L	2002 - 1999
CHEVROLET	TRAILBLAZER	6 CIL, 4.2 L	2004 - 2002
FORD	F SERIES PICKUP	V-8, 5.4 L	2002 - 1999
FORD	EXPEDITION	V-8, 5.4 L	2002 - 1999
LINCOLN	NAVIGATOR	V-8, 5.4 L	1999 - 1999

**19199**



FORD	EXPEDITION	V-8, 4.6 L	2002 - 2000
FORD	LOBO	V-8, 5.4 L	2002 - 2002

FORD	F SERIES PICKUP	V-8, 4.6 L	2001 - 2000
FORD	EXPEDITION	V-8, 5.4 L	2002 - 2000
FORD	F SERIES PICKUP	V-8, 5.4 L	2002 - 2000

**19200**



FORD	SUPER DUTY PICKUP	V-8, 7.3 L	2002 - 1999
------	-------------------	------------	-------------

**19201**



FORD	SUPER DUTY PICKUP	V-8, 7.3 L	2002 - 1999
------	-------------------	------------	-------------

**19202**



FORD	SUPER DUTY VAN	V-8, 7.3 L	2001 - 1999
------	----------------	------------	-------------

**19203**

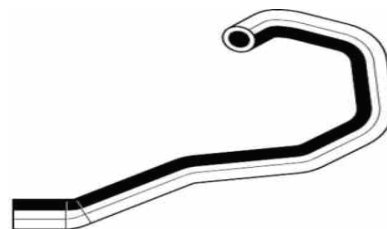

NISSAN	FRONTIER	V-6, 3.3 L	2002 - 2002
NISSAN	XTERRA	V-6, 3.3 L	2002 - 2002

19210



CHEVROLET	MONTE CARLO	V-6, 3.4 L	2005	-	2004
CHEVROLET	VENTURE	V-6, 3.4 L	2004	-	2003
CHEVROLET	IMPALA	V-6, 3.4 L	2004	-	2003

19211



PONTIAC	GRAND PRIX	V-6, 3.1 L	2002	-	2000
CHEVROLET	IMPALA	V-6, 3.4 L	2004	-	2000
CHEVROLET	MONTE CARLO	V-6, 3.4 L	2005	-	2004

19212



NISSAN	FRONTIER	4 CIL, 2.4 L	2002	-	1999
NISSAN	XTERRA	4 CIL, 2.4 L	2002	-	2000

19213



NISSAN	FRONTIER	4 CIL, 2.4 L	2002	-	1999
NISSAN	XTERRA	4 CIL, 2.4 L	2002	-	2000

19214



NISSAN	SENTRA	4 CIL, 1.8 L	2002	-	2000
--------	--------	--------------	------	---	------

19218



FORD	SUPER DUTY PICKUP	V-10, 6.8 L	2000	-	1999
FORD	SUPER DUTY PICKUP	V-8, 5.4 L	2001	-	1999

19219



FORD	EXPEDITION	V-8, 4.6 L	1999	-	1999
FORD	LOBO	V-8, 5.4 L	2002	-	2002
FORD	EXPEDITION	V-8, 5.4 L	1999	-	1999
LINCOLN	NAVIGATOR	V-8, 5.4 L	2000	-	1999
FORD	F SERIES PICKUP	V-8, 4.6 L	1999	-	1999
FORD	F SERIES PICKUP	V-8, 5.4 L	2002	-	2000

19225



CHEVROLET	EXPRESS	V-8, 5.7 L	2002	-	1999
CHEVROLET	EXPRESS	V-8, 5.0 L	2002	-	1999

19226



CHEVROLET	VENTURE	V-6, 3.4 L	2004	-	2003
-----------	---------	------------	------	---	------

19279



C/AA

CHEVROLET	EXPRESS	V-8, 5.3 L	2006	-	2005
CHEVROLET	EXPRESS	V-8, 5.3 L	2007	-	2007
CADILLAC	DEVILLE	V-8, 4.6 L	2003	-	2002
CHEVROLET	EXPRESS	V-8, 5.3 L	2004	-	2004
CHEVROLET	EXPRESS	V-8, 6.0 L	2004	-	2004
CHEVROLET	EXPRESS	V-8, 6.0 L	2007	-	2007

19227



FORD	RANGER	4 CIL, 2.3 L	2001	-	2001
------	--------	--------------	------	---	------

19280



CADILLAC	DEVILLE	V-8, 4.6 L	2003	-	2003
----------	---------	------------	------	---	------

19234



CHRYSLER	CIRRUS	4 CIL, 2.0 L	2000	-	2000
DODGE	STRATUS	4 CIL, 2.0 L	2000	-	1999

19285



19235



LINCOLN	LS	V-8, 3.9 L	2002	-	2000
JAGUAR	S-TYPE	V-8, 4.0 L	2005	-	2000

JEEP	GRAND CHEROKEE	6 CIL, 4.0 L	2002	-	2002
JEEP	GRAND CHEROKEE	V-6, 4.0 L	2003	-	2003

19286



FORD	E SERIES VAN	V-6, 4.2 L	2003	-	2001
FORD	SUPER DUTY VAN	V-6, 4.2 L	2001	-	2001

19287



PONTIAC AZTEK V-6, 3.4 L 2004 - 2004

19288



PONTIAC AZTEK V-6, 3.4 L 2004 - 2004

19305



FORD ESCAPE V-6, 3.0 L 2004 - 2004

19320



CHEVROLET IMPALA V-6, 3.8 L 2004 - 2004

19321



CHEVROLET IMPALA V-6, 3.8 L 2004 - 2004

19329



HONDA CIVIC 4 CIL, 1.7 L 2005 - 2004

19330



HONDA CIVIC 4 CIL, 1.7 L 2005 - 2004

19331



HONDA CIVIC 4 CIL, 1.7 L 2005 - 2004

19332



HONDA CIVIC 4 CIL, 1.7 L 2005 - 2004

19335





## Aplicación por Producto

MAZDA MAZDA 6 4 CIL, 2.3 L 2008 - 2008

**19336**



MAZDA MAZDA 6 4 CIL, 2.3 L 2008 - 2008

**19339**



HONDA CR-V 4 CIL, 2.4 L 2006 - 2006

**19361**



CHRYSLER 300 C V-8, 6.1 L 2006 - 2005

CHRYSLER 300 C V-8, 5.7 L 2006 - 2005

**19415**



MAZDA MAZDA 6 4 CIL, 2.3 L 2008 - 2008

**19416**



MAZDA MAZDA 6 4 CIL, 2.3 L 2008 - 2008

**19447**



MAZDA MAZDA 6 4 CIL, 2.3 L 2008 - 2008

**19466**



MAZDA MAZDA 6 4 CIL, 2.3 L 2008 - 2008

**19467**



MAZDA MAZDA 6 4 CIL, 2.3 L 2008 - 2008

**19468**



MAZDA MAZDA 6 4 CIL, 2.3 L 2008 - 2008

19469



TOYOTA CAMRY V-6, 3.5 L 2008 - 2011

19478



CHEVROLET HHR 4 CIL, 2.4 L 2009 - 2008

19482



JEEP WRANGLER V-6, 3.8 L 2008 - 2010

19498



HONDA ACCORD 4 CIL, 2.4 L 2008 - 2010  
 ACURA TSX 4 CIL, 2.4 L 2010 - 2010  
 HONDA CR-V 4 CIL, 2.4 L 2007 - 2009

19499



CHEVROLET MALIBU V-6, 3.6 L 2008 - 2010

19508



JEEP GRAND CHEROKEE V-6, 3.7 L 2008 - 2009

19509



JEEP GRAND CHEROKEE V-6, 3.7 L 2008 - 2009

19510



DODGE NITRO V-6, 3.7 L 2009 - 2010  
 JEEP LIBERTY V-6, 3.7 L 2008 - 2009

19511



## Aplicación por Producto

DODGE	NITRO	V-6, 3.7 L	2009	-	2010
JEEP	LIBERTY	V-6, 3.7 L	2008	-	2009

**19514**



JEEP	GRAND CHEROKEE	V-8, 5.7 L	2008	-	2009
JEEP	GRAND CHEROKEE	V-8, 6.1 L	2008	-	2009

**19519**



mitsubishi	OUTLANDER	V-6, 3.0 L	2007	-	2008
------------	-----------	------------	------	---	------

**19520**



mitsubishi	OUTLANDER	V-6, 3.0 L	2007	-	2008
------------	-----------	------------	------	---	------

**19545**



SUZUKI	GRAND VITARA	V-6, 3.2 L	2009	-	2010
--------	--------------	------------	------	---	------

**19550**



HONDA	CIVIC	4 CIL, 1.8 L	2008	-	2010
-------	-------	--------------	------	---	------

**19552**



HONDA	CIVIC	4 CIL, 1.8 L	2008	-	2010
-------	-------	--------------	------	---	------

**19605**



CADILLAC	SEVILLE	V-8, 4.6 L	2003	-	2002
----------	---------	------------	------	---	------

**19607**



NISSAN	FRONTIER	4 CIL, 2.4 L	2002	-	1999
NISSAN	XTERRA	4 CIL, 2.4 L	2004	-	2000

**19610**



## Aplicación por Producto

VOLKSWAGEN	PASSAT	4 CIL, 2.0 L	1993	-	1993
------------	--------	--------------	------	---	------

**19663**

**19611**



CHEVROLET	C y K SERIES PICKUP	V-8, 6.5 L	1999	-	1999
-----------	---------------------	------------	------	---	------

CHEVROLET	CAVALIER	4 CIL, 2.2 L	2004	-	2002
PONTIAC	SUNFIRE	4 CIL, 2.2 L	2004	-	2002

**19665**

**19627**



SUZUKI	SWIFT	4 CIL, 1.6 L	2009	-	2009
--------	-------	--------------	------	---	------

CHEVROLET	EXPRESS	V-8, 5.3 L	2006	-	2003
CHEVROLET	EXPRESS	V-8, 5.3 L	2006	-	2005
CHEVROLET	EXPRESS	V-8, 6.0 L	2006	-	2003
CHEVROLET	EXPRESS	V-8, 6.0 L	2007	-	2007
CHEVROLET	EXPRESS	V-8, 5.3 L	2007	-	2007

**19658**



**19666**



CADILLAC	EL DORADO	V-8, 4.6 L	1999	-	1999
CADILLAC	DEVILLE	V-8, 4.6 L	2003	-	1999
CADILLAC	SEVILLE	V-8, 4.6 L	2003	-	1999

CHEVROLET	EXPRESS	V-8, 8.1 L	2002	-	2001
-----------	---------	------------	------	---	------

**19661**



**19670**



VOLKSWAGEN	JETTA	V-6, 2.8 L	2001	-	1999
VOLKSWAGEN	GTI	V-6, 2.8 L	2001	-	1999

CHEVROLET	EXPRESS	V-8, 7.4 L	2000	-	1999
CHEVROLET	C y K SERIES PICKUP	V-8, 7.4 L	2000	-	1999

19672



CHEVROLET	C y K SERIES PICKUP	V-8, 6.5 L	2002 - 1999
-----------	---------------------	------------	-------------

19699



HONDA	ACCORD	V-6, 3.0 L	2002 - 1999
-------	--------	------------	-------------

19673



CHEVROLET	CAMARO Z28	V-8, 5.7 L	2002 - 1999
PONTIAC	FIREBIRD TRANS AM	V-8, 5.7 L	2002 - 1999
CHEVROLET	CAMARO Z28	V-6, 3.8 L	2002 - 1999

19700



CHEVROLET	EXPRESS	V-6, 4.3 L	2003 - 2002
CADILLAC	CATERA	V-6, 3.0 L	2001 - 1998
CHEVROLET	EXPRESS	V-8, 5.7 L	2002 - 2002
CHEVROLET	TRAILBLAZER	6 CIL, 4.2 L	2004 - 2002

19692



FORD	WINDSTAR	V-6, 3.8 L	2003 - 1999
------	----------	------------	-------------

19703



CHEVROLET	CAVALIER	4 CIL, 2.2 L	1999 - 1999
-----------	----------	--------------	-------------

19698



CHEVROLET	EQUINOX	V-6, 3.4 L	2007 - 2005
CADILLAC	CATERA	V-6, 3.0 L	2001 - 1998

19704



PONTIAC	SUNFIRE	4 CIL, 2.2 L	1999 - 1999
PONTIAC	SUNFIRE	4 CIL, 2.4 L	1999 - 1999
CHEVROLET	CAVALIER	4 CIL, 2.2 L	1999 - 1999



19705



VOLKSWAGEN	BEETLE	4 CIL, 2.0 L	2002 - 1999
------------	--------	--------------	-------------

19706



VOLKSWAGEN	CABRIO	4 CIL, 2.0 L	2002 - 1999
VOLKSWAGEN	BEETLE	4 CIL, 2.0 L	2002 - 1999

19707



CHEVROLET	S-10	V-6, 4.3 L	2002 - 1999
CHEVROLET	BLAZER	V-6, 4.3 L	2005 - 1999

19708



DODGE	INTREPID	V-6, 3.2 L	2001 - 1999
DODGE	INTREPID	V-6, 3.5 L	2002 - 2000
CHRYSLER	300M	V-6, 3.5 L	2003 - 1999
VOLKSWAGEN	CABRIO	4 CIL, 2.0 L	2002 - 1999
CHRYSLER	CONCORDE	V-6, 3.2 L	2001 - 1999

19709



DODGE	INTREPID	V-6, 3.5 L	2002 - 2002
CHRYSLER	300M	V-6, 3.5 L	2003 - 2002
CHRYSLER	CONCORDE	V-6, 3.5 L	2002 - 2002

19710



DODGE	INTREPID	V-6, 3.2 L	2001 - 1999
CHRYSLER	CONCORDE	V-6, 3.5 L	2002 - 2002
DODGE	INTREPID	V-6, 3.5 L	2002 - 2000
CHRYSLER	CONCORDE	V-6, 3.2 L	2001 - 1999
CHRYSLER	300M	V-6, 3.5 L	2002 - 1999

19711



DODGE	INTREPID	V-6, 2.7 L	2003 - 2002
-------	----------	------------	-------------

19712



CHRYSLER	CONCORDE	V-6, 2.7 L	2000 - 1999
DODGE	INTREPID	V-6, 2.7 L	2003 - 1999

19714



CADILLAC	EL DORADO	V-8, 4.6 L	1999 - 1999
CADILLAC	SEVILLE	V-8, 4.6 L	2003 - 1999
CADILLAC	DEVILLE	V-8, 4.6 L	1999 - 1999

19724



OLDSMOBILE	EIGHTY EIGHT	V-6, 3.8 L	1999 - 1998
PONTIAC	BONNEVILLE	V-6, 3.8 L	1999 - 1999

19717



CADILLAC	DEVILLE	V-8, 4.6 L	2003 - 2002
----------	---------	------------	-------------

19726



MERCURY	SABLE / TAURUS	V-6, 3.0 L	2002 - 2002
FORD	WINDSTAR	V-6, 3.8 L	2003 - 2002

19722



NISSAN	ALTIMA	V-6, 3.5 L	2009 - 2009
NISSAN	MAXIMA	V-6, 3.5 L	2009 - 2009

19727

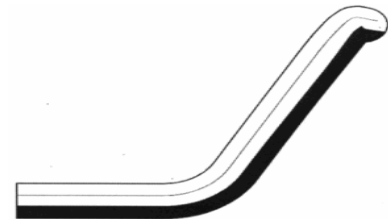

LINCOLN	TOWN CAR	V-8, 4.6 L	2002 - 1999
---------	----------	------------	-------------

19723

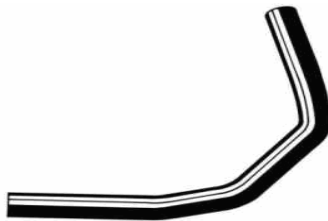

OLDSMOBILE	EIGHTY EIGHT	V-6, 3.8 L	1999 - 1998
------------	--------------	------------	-------------

19728



FORD	MUSTANG	V-8, 4.6 L	2001 - 1999
------	---------	------------	-------------

19729



FORD	MUSTANG	V-8, 4.6 L	1999	-	1999
CHEVROLET	EXPRESS	V-8, 5.3 L	2007	-	2004
CHEVROLET	EXPRESS	V-8, 6.0 L	2007	-	2004

19741



PONTIAC	SUNFIRE	4 CIL, 2.2 L	1999	-	1999
---------	---------	--------------	------	---	------

19734



CADILLAC	EL DORADO	V-8, 4.6 L	2002	-	2000
----------	-----------	------------	------	---	------

19746

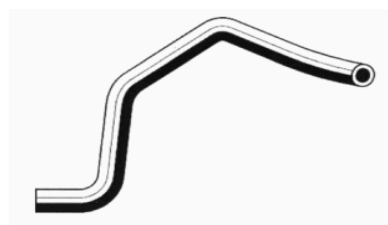

FORD	FOCUS	4 CIL, 2.0 L	2002	-	2000
------	-------	--------------	------	---	------

19736



CHEVROLET	CAVALIER	4 CIL, 2.2 L	2002	-	2002
FORD	WINDSTAR	V-6, 3.8 L	2003	-	1999
PONTIAC	SUNFIRE	4 CIL, 2.2 L	2002	-	2002

19747



CHEVROLET	S-10	4 CIL, 2.2 L	2003	-	1999
-----------	------	--------------	------	---	------

19739



PONTIAC	GRAND AM	4 CIL, 2.4 L	2001	-	1999
FORD	WINDSTAR	V-6, 3.8 L	2003	-	2002

19748



HONDA	ODYSSEY	V-6, 3.5 L	2002	-	1999
-------	---------	------------	------	---	------

19749



CHEVROLET	EXPRESS	V-8, 5.3 L	2007	-	2003
-----------	---------	------------	------	---	------

## Aplicación por Producto

CHEVROLET	EXPRESS	V-8, 6.0 L	2007 - 2003
HONDA	ODYSSEY	V-6, 3.5 L	2002 - 1999

**19750**



HONDA	ODYSSEY	V-6, 3.5 L	2002 - 2002
CHEVROLET	EXPRESS	V-8, 6.0 L	2004 - 2004
CHEVROLET	EXPRESS	V-8, 5.3 L	2004 - 2004
CHEVROLET	EXPRESS	V-8, 5.3 L	2007 - 2007
CHEVROLET	EXPRESS	V-8, 5.3 L	2006 - 2005
CHEVROLET	EXPRESS	V-8, 6.0 L	2006 - 2005
CHEVROLET	EXPRESS	V-8, 6.0 L	2007 - 2007

**19751**

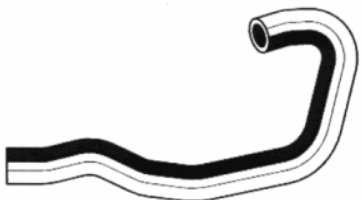

NISSAN	PATHFINDER	V-6, 3.3 L	2000 - 1999
--------	------------	------------	-------------

**19752**

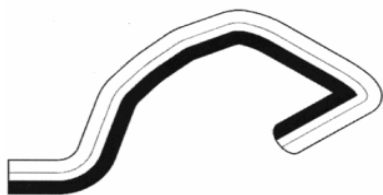

NISSAN	PATHFINDER	V-6, 3.3 L	2000 - 1999
--------	------------	------------	-------------

**19754**



JAGUAR	S-TYPE	V-8, 4.0 L	2005 - 2000
LINCOLN	LS	V-8, 3.9 L	2002 - 2000

**19756**



NISSAN	MAXIMA	V-6, 3.0 L	1999 - 1999
--------	--------	------------	-------------

**19760**

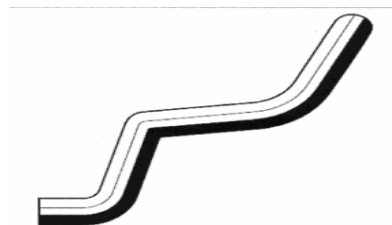

PONTIAC	GRAND AM	V-6, 3.4 L	2004 - 2002
CHEVROLET	MALIBU	V-6, 3.1 L	2003 - 2002

**19761**



CHEVROLET	EXPRESS	V-8, 6.0 L	2007 - 2004
CHEVROLET	EXPRESS	V-8, 5.3 L	2007 - 2004

**19764**



MERCURY	GRAND MARQUIS	V-8, 4.6 L	2002 - 1999
FORD	CROWN VICTORIA	V-8, 4.6 L	1999 - 1999

**19766**



NISSAN ALTIMA 4 CIL, 2.4 L 2001 - 1999

**19773**



CHEVROLET EXPRESS V-8, 5.7 L 2002 - 2002

**19768**



NISSAN	PATHFINDER	V-6, 3.5 L	2002 - 2001
PONTIAC	G6	V-6, 3.9 L	2006 - 2006
PONTIAC	MONTANA	V-6, 3.9 L	2008 - 2006
CHEVROLET	UPLANDER	V-6, 3.9 L	2007 - 2009
PONTIAC	G6	V-6, 3.5 L	2008 - 2007

**19783**

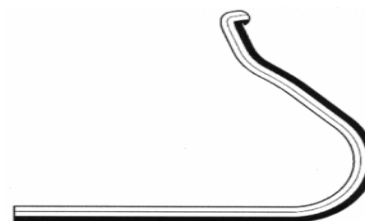

CHEVROLET C y K SERIES PICKUP V-8, 7.4 L 2000 - 2000

**19769**



NISSAN PATHFINDER V-6, 3.5 L 2002 - 2001

**19788**



VOLKSWAGEN BEETLE 4 CIL, 1.8 L 2001 - 1999

**19770**



NISSAN PATHFINDER V-6, 3.5 L 2002 - 2002

**19790**

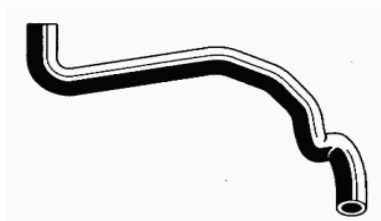

VOLKSWAGEN	PASSAT	V-6, 2.8 L	2001 - 1999
AUDI	A6	V-6, 2.8 L	2001 - 1999

**19793**





## Aplicación por Producto

VOLKSWAGEN	PASSAT	4 CIL, 1.8 L	2003 - 1999
AUDI	A4	4 CIL, 1.8 L	2000 - 1999

### 19802



CHEVROLET	SUBURBAN	V-8, 8.1 L	2006 - 2003
-----------	----------	------------	-------------

### 19805

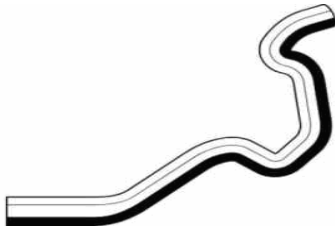

FORD	FREESTAR	V-6, 3.9 L	2006 - 2006
FORD	WINDSTAR	V-6, 3.8 L	2003 - 2002
FORD	FREESTAR	V-6, 4.2 L	2007 - 2006

### 19806



CHEVROLET	TRAILBLAZER	6 CIL, 4.2 L	2004 - 2004
JAGUAR	S-TYPE	V-8, 4.0 L	2005 - 2002
LINCOLN	LS	V-8, 3.9 L	2002 - 2002

### 19807



JAGUAR	S-TYPE	V-8, 4.0 L	2005 - 2002
LINCOLN	LS	V-8, 3.9 L	2002 - 2002

### 19810

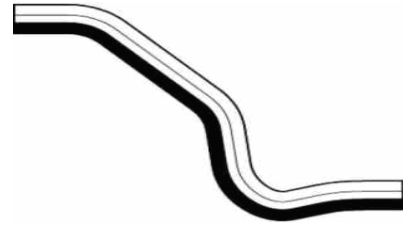

PONTIAC	SUNFIRE	4 CIL, 2.2 L	2002 - 2002
NISSAN	ALTIMA	V-6, 3.5 L	2009 - 2009
CHEVROLET	CAVALIER	4 CIL, 2.2 L	2002 - 2002
NISSAN	MAXIMA	V-6, 3.5 L	2009 - 2009

### 19811



PONTIAC	SUNFIRE	4 CIL, 2.2 L	2002 - 2000
CHEVROLET	CAVALIER	4 CIL, 2.2 L	2002 - 2000

### 19815



CHEVROLET	CAVALIER	4 CIL, 2.2 L	2004 - 2003
CHEVROLET	MALIBU	4 CIL, 2.2 L	2004 - 2004
PONTIAC	SUNFIRE	4 CIL, 2.2 L	2004 - 2004

### 19816



PONTIAC	SUNFIRE	4 CIL, 2.2 L	2004 - 2004
CHEVROLET	CAVALIER	4 CIL, 2.2 L	2004 - 2003
CHEVROLET	MALIBU	4 CIL, 2.2 L	2004 - 2004

19848

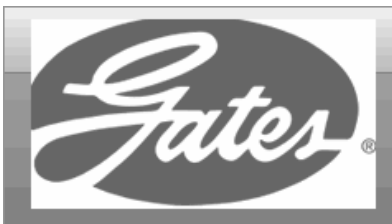

CHEVROLET HHR 4 CIL, 2.4 L 2009 - 2008

19857



CHEVROLET MALIBU V-6, 3.6 L 2008 - 2010

19858



CHEVROLET MALIBU V-6, 3.6 L 2008 - 2010

19865



NISSAN ARMADA V-8, 5.6 L 2006 - 2010

20157



1 1/16" x 12 3/16"

CHEVROLET TRACKER 4 CIL, 1.6 L 1998 - 1997

20226



1 1/2" x 16 3/16"

DODGE DURANGO V-8, 5.9 L 2000 - 2000

20230



1 1/2" x 17 3/16"

FORD EXPLORER V-6, 4.0 L 2001 - 1997

20294



1 1/2" x 12 13/16"

CADILLAC DEVILLE V-8, 4.6 L 2005 - 1997

CADILLAC SEVILLE V-8, 4.6 L 2004 - 2000

20333



13/16" x 6 29/32"

DODGE INTREPID V-6, 2.7 L 2003 - 1999

CHRYSLER CONCORDE V-6, 2.7 L 2000 - 1999

CHRYSLER CONCORDE V-6, 3.3 L 1996 - 1993

20338



5/8" x 4 29/32"

DODGE	RAM SERIES PICKUP	6 CIL, 5.9 L Diesel	2002	-	1999
CADILLAC	ESCALADE	V-8, 5.7 L	2000	-	1999

20473



1 1/2" x 12 13/16"

SUBARU	LEGACY	4 CIL, 2.5 L	2007	-	2006
SUBARU	OUTBACK	4 CIL, 2.5 L	2007	-	2006

20355



1 1/2" x 14"

FORD	E SERIES VAN	V-6, 4.9 L	1996	-	1995
------	--------------	------------	------	---	------

20511



1 1/2" x 14 13/16"

FORD	AEROSTAR	V-6, 4.0 L	1995	-	1995
------	----------	------------	------	---	------

20370



1 1/2" x 17"

DODGE	DURANGO	V-8, 5.9 L	2000	-	2000
-------	---------	------------	------	---	------

20516



1 3/4" x 14 19/32"

FORD	E SERIES VAN	V-6, 4.9 L	1996	-	1995
------	--------------	------------	------	---	------

20470



1 1/2" x 18 11/16"

FORD	EXPLORER	V-6, 4.0 L	2002	-	1997
FORD	EXPLORER SPORT TRAC	V-6, 4.0 L	2006	-	2004

20559



1 1/2" x 1 3/4" x 15 11/16"

JEEP	CHEROKEE	4 CIL, 2.5 L	1997	-	1996
JEEP	CHEROKEE	6 CIL, 4.0 L	1998	-	1998

20563



1 9/32" x 6 5/16"

NISSAN	ALTIMA	4 CIL, 2.4 L	1995	-	1994
--------	--------	--------------	------	---	------

20568



1" x 8 1/2"

NISSAN	PATHFINDER LE 4X2	V-6, 3.3 L	2000	-	1997
--------	-------------------	------------	------	---	------

20609



1 3/4" x 16 13/16"

FORD	F SERIES PICKUP	V-6, 4.9 L	1997	-	1995
FORD	F-150	V-6, 4.9 L	1997	-	1995

20618



3/4" x 4 29/32"

DODGE	INTREPID	V-6, 2.7 L	2003	-	1999
CHRYSLER	CONCORDE	V-6, 3.3 L	1996	-	1993
CHRYSLER	CONCORDE	V-6, 2.7 L	2000	-	1999
CHEVROLET	CAVALIER	4 CIL, 2.2 L	2002	-	2000
PONTIAC	SUNFIRE	4 CIL, 2.2 L	2002	-	2000

20661



1 1/4" x 11 13/32"

NISSAN	ALTIMA	4 CIL, 2.4 L	2000	-	1999
SUZUKI	GRAND VITARA	V-6, 2.5 L	2005	-	2004
CHEVROLET	TRACKER	V-6, 2.5 L	2004	-	2002
SUZUKI	XL-7	V-6, 2.7 L	2006	-	2005

20662



5/8" x 3/4" x 5 3/16"

FORD	EXPLORER	V-8, 5.0 L	2001	-	1999
------	----------	------------	------	---	------

20685



2" x 9 3/16"

HUMMER	H1	V-8, 6.6 L	2007	-	2006
--------	----	------------	------	---	------

20776



1 3/8" x 9 1/2"

NISSAN	MURANO	V-6, 3.5 L	2009	-	2010
--------	--------	------------	------	---	------

## Aplicación por Producto

**20786**



1 3/8" x 1 9/16" x 14 1/2"

CHEVROLET	CORVETTE	V-8, 5.7 L	1995	-	1994
-----------	----------	------------	------	---	------

**20795**



1 1/4" x 20 3/16"

NISSAN	MAXIMA	V-6, 3.0 L	2004	-	1993
NISSAN	ALTIMA	4 CIL, 2.4 L	2001	-	1994

**20808**



1 5/16" x 11 29/32"

CHRYSLER	SEBRING	V-6, 2.5 L	2000	-	1997
----------	---------	------------	------	---	------

**20823**



1 1/2" x 26 19/32"

FORD	EXPLORER	V-6, 4.0 L	1996	-	1995
------	----------	------------	------	---	------

**20850**



1 3/16" x 21 13/16"

CHRYSLER	CONCORDE	V-6, 3.5 L	1997	-	1993
CHRYSLER	NEW YORKER	V-6, 3.5 L	1997	-	1994

**20887**



1 1/2" x 1 3/4" x 6 1/2"

FORD	MUSTANG	V-8, 4.6 L	2001	-	1997
------	---------	------------	------	---	------

**20893**



1 1/4" x 27 1/2"

DODGE	STRATUS	4 CIL, 2.0 L	2004	-	2004
DODGE	NEON	4 CIL, 2.0 L	2004	-	2000
DODGE	NEON	4 CIL, 2.0 L	2005	-	2005

**20900**



1 1/2" x 8 29/32"

FORD	WINDSTAR	V-6, 3.8 L	1998	-	1995
------	----------	------------	------	---	------

**20931**



1 1/2" x 1 3/4" x 16 1/2"

JEEP	WRANGLER	V-6, 4.0 L	2004	-	2004
JEEP	WRANGLER	6 CIL, 4.0 L	2006	-	1999



20940



1 1/4" x 10"

CHEVROLET	TRACKER	4 CIL, 2.0 L	2003	-	1999
NISSAN	PATHFINDER LE 4X2	V-6, 3.3 L	2000	-	1997
NISSAN	PATHFINDER	V-6, 3.3 L	2000	-	1998

20942



1 1/4" x 15 13/32"

SUZUKI	SWIFT	4 CIL, 1.6 L	2007	-	2008
PONTIAC	G3	4 CIL, 1.6 L	2008	-	2006
CHEVROLET	AVEO	4 CIL, 1.6 L	2009	-	2009
CHEVROLET	AVEO	4 CIL, 1.6 L	2008	-	2008

20953



1 1/2" x 12 5/16"

SUBARU	FORESTER	4 CIL, 2.5 L	2007	-	2006
--------	----------	--------------	------	---	------

20982



1 1/2" x 16 5/16"

FORD	RANGER F-100	4 CIL, 2.3 L	1994	-	1993
------	--------------	--------------	------	---	------

20983



1 1/2" x 31"

FORD	RANGER F-100	V-6, 4.0 L	1997	-	1995
------	--------------	------------	------	---	------

21063



1 1/4" x 19 1/2"

NISSAN	ALTIMA	4 CIL, 2.4 L	2000	-	2000
CHRYSLER	LEBARON	V-6, 3.0 L	1995	-	1993

21085



1 1/4" x 13 1/2"

CHEVROLET	CORVETTE	V-8, 5.7 L	1994	-	1993
-----------	----------	------------	------	---	------

21087



1 1/4" x 1 1/2" x 19 5/16"

JEEP	CHEROKEE	6 CIL, 4.0 L	1998	-	1998
JEEP	CHEROKEE	4 CIL, 2.5 L	1998	-	1996

21140



1 7/32" x 1 9/32" x 11 3/32"

CHEVROLET	CORVETTE	V-8, 5.7 L	1994	-	1993
-----------	----------	------------	------	---	------

21145



1 1/2" x 7 19/32"

FORD	EXPLORER	V-6, 4.0 L	2003	-	1997
------	----------	------------	------	---	------

21164



1 1/4" x 20 19/32"

CHRYSLER	PHANTOM R/T	4 CIL, 2.5 L	1995	-	1993
----------	-------------	--------------	------	---	------

21171



1 1/4" x 14"

CHEVROLET	CAPTIVA	4 CIL. 2.4 L	2008	-	2010
-----------	---------	--------------	------	---	------

21178



1 1/2" x 1 3/4" x 19 13/32"

FORD	THUNDERBIRD	V-8, 5.0 L	1993	-	1993
------	-------------	------------	------	---	------

21188



1 1/4" x 32"

CHEVROLET	SUBURBAN	V-8, 5.7 L	1999	-	1999
CHEVROLET	P-30	V-8, 5.7 L	1996	-	1996

21191



1 1/4" x 1 1/2" x 38 19/32"

CHEVROLET	C-3500	V-8, 5.7 L	1995	-	1994
CHEVROLET	C y K SERIES PICKUP	V-8, 5.7 L	1996	-	1993

21193



1 1/4" x 1 1/2" x 20 3/16"

DODGE	ADVENTURER	V-6, 3.3 L	1994	-	1993
-------	------------	------------	------	---	------

21220



1 1/2" x 23 13/32"

FORD	F SERIES PICKUP	V-8, 5.0 L	1997	-	1995
FORD	F-350 XL	V-8, 5.0 L	1998	-	1993

## Aplicación por Producto

21281



1 1/4" x 14 19/32"

CHEVROLET	LUMINA	V-6, 3.4 L	1996	-	1996
OLDSMOBILE	SILHOUETTE	V-6, 3.4 L	1996	-	1996

21329



19/16" x 1 13/16" x 24 11/16"

JEEP	WRANGLER	4 CIL, 2.5 L	1995	-	1993
------	----------	--------------	------	---	------

21347



1 1/4" x 21 29/32"

PONTIAC	GRAND AM	4 CIL, 2.4 L	1998	-	1998
---------	----------	--------------	------	---	------

21352



1 11/32" x 21 13/32"

CHEVROLET	TRACKER	4 CIL, 1.6 L	1999	-	1999
-----------	---------	--------------	------	---	------

21354



1 1/16" x 13 11/16"

CHEVROLET	TRACKER	4 CIL, 1.6 L	1997	-	1997
-----------	---------	--------------	------	---	------

21356



1 3/8" x 14 1/2"

NISSAN	ALTIMA	4 CIL, 2.4 L	1999	-	1994
--------	--------	--------------	------	---	------

21361



1 1/4" x 1 5/16" x 17 5/16"

OLDSMOBILE	SILHOUETTE	V-6, 3.1 L	1994	-	1993
------------	------------	------------	------	---	------

21390



1 1/4" x 14 13/16"

DODGE	STRATUS	4 CIL, 2.4 L	2003	-	2001
-------	---------	--------------	------	---	------

CHRYSLER	SEBRING	4 CIL, 2.4 L	2006	-	2004
----------	---------	--------------	------	---	------

21394



1 1/4" x 20 19/32"

FORD	TOPAZ	4 CIL, 2.3 L	1994	-	1994
------	-------	--------------	------	---	------

21398



1 3/8" x 13 19/32"

CHEVROLET	TRACKER	4 CIL, 1.6 L	2000	-	1999
-----------	---------	--------------	------	---	------

21461



1 3/16" x 3 11/16"

SUZUKI	GRAND VITARA	4 CIL, 2.4 L	2009	-	2010
TOYOTA	COROLLA	4 CIL, 2.4 L	2009	-	2010
TOYOTA	MATRIX	4 CIL, 2.4 L	2009	-	2010

21404



1 1/16" x 11 5/16"

CHEVROLET	TRACKER	4 CIL, 1.6 L	1998	-	1997
HONDA	CIVIC	4 CIL, 1.6 L	2000	-	1997
SUBARU	B9 TRIBECA	6 CIL, 3.0 L	2007	-	2006

21478



1" x 1 1/4" x 17 5/16"

CHRYSLER	PHANTOM R/T	4 CIL, 2.5 L	1995	-	1993
----------	-------------	--------------	------	---	------

21425



1 9/16" x 1 5/8" x 13 29/32"

CADILLAC	DEVILLE	V-8, 4.9 L	1993	-	1993
----------	---------	------------	------	---	------

21488



1" x 14"

HUMMER	H1	V-8, 6.6 L	2007	-	2006
--------	----	------------	------	---	------

21439



1 1/4" x 17 13/32"

CHEVROLET	CAMARO Z28	V-8, 5.7 L	1997	-	1996
FORD	ESCORT	4 CIL, 1.8 L	1996	-	1994
PONTIAC	TRANS AM FIREBIRD	V-8, 5.7 L	1997	-	1996
PONTIAC	FIREBIRD TRANS AM	V-8, 5.7 L	1997	-	1997

21508



1 7/32" x 19 3/32"

CHRYSLER	CIRRUS	V-6, 2.5 L	2000	-	1995
CHRYSLER	SEBRING	V-6, 2.5 L	2000	-	2000
DODGE	STRATUS	V-6, 2.5 L	1999	-	1999
CHRYSLER	SEBRING	V-6, 2.5 L	1999	-	1996

21514



1 1/4" x 14 5/16"

FORD	ESCORT	4 CIL, 2.0 L	2002	-	1999
------	--------	--------------	------	---	------

21532



1 1/4" x 11 19/32"

VOLKSWAGEN	BEETLE	4 CIL, 1.8 L	2001	-	1999
CHEVROLET	TRACKER	4 CIL, 1.6 L	2000	-	2000

21528



1 1/4" x 10 3/32"

CHEVROLET	CAMARO Z28	V-8, 5.7 L	2002	-	1999
DODGE	RAM RUNNER	V-10, 8.0 L	2000	-	1995
DODGE	RAM SERIES PICKUP	V-10, 8.0 L	2002	-	1999
PONTIAC	FIREBIRD TRANS AM	V-8, 5.7 L	2002	-	1999

21534



1 1/4" x 15 19/32"

SUZUKI	XL-7	V-6, 2.7 L	2006	-	2005
TOYOTA	4 RUNNER	V-6, 3.4 L	2002	-	2002
VOLKSWAGEN	JETTA	4 CIL, 1.9 L DIESE	2001	-	2000

21529



1 3/16" x 1 3/8" x 24 1/2"

JEEP	WRANGLER	4 CIL, 2.5 L	1995	-	1993
------	----------	--------------	------	---	------

21551



1 3/16" x 9"

SUZUKI	GRAND VITARA	4 CIL, 2.4 L	2009	-	2010
--------	--------------	--------------	------	---	------

21531



1 1/4" x 10 11/16"

SUZUKI	SWIFT	4 CIL, 1.6 L	2007	-	2008
VOLKSWAGEN	JETTA	4 CIL, 1.9 L DIESE	2001	-	2000
PONTIAC	G3	4 CIL, 1.6 L	2008	-	2006
CHEVROLET	AVEO	4 CIL, 1.6 L	2008	-	2008
CHEVROLET	AVEO	4 CIL, 1.6 L	2009	-	2009

21557



1 1/4" x 18"

CHRYSLER	SEBRING	V-6, 3.0 L	2006	-	2004
MITSUBISHI	ECLIPSE	V-6, 3.0 L	2005	-	2004
PONTIAC	GRAND AM	V-6, 3.1 L	1998	-	1997
CHRYSLER	SEBRING	V-6, 3.0 L	2005	-	2005
DODGE	STRATUS	V-6, 3.0 L	2002	-	2001



## Aplicación por Producto

**21585**



1 1/2" x 20 29/32"

PONTIAC	BONNEVILLE	V-6, 3.8 L	1994	-	1994
---------	------------	------------	------	---	------

**21586**



1 3/16" x 16 13/16"

HONDA	ODYSSEY	V-6, 3.5 L	2002	-	1999
-------	---------	------------	------	---	------

**21589**



1 3/16" x 1 5/16" x 18 11/16"

MERCURY	COUGAR XR7	V-6, 3.8 L	1994	-	1993
---------	------------	------------	------	---	------

**21591**



1 3/16" x 1 5/16" x 14 5/16"

SAAB	9 - 3	4 CIL, 2.0 L	2007	-	2003
CHEVROLET	TRACKER	4 CIL, 1.6 L	2000	-	1999

**21592**



1 1/4" x 14 13/32"

NISSAN	TITAN	V-8, 5.6 L	2009	-	2009
NISSAN	ARMADA	V-8, 5.6 L	2006	-	2009

**21594**



1 1/4" x 1 1/2" x 17 3/16"

CHRYSLER	GRAND VOYAGER	V-6, 3.8 L	1995	-	1994
CHRYSLER	TOWN & COUNTRY	V-6, 3.8 L	1995	-	1994

**21596**



1 3/8" x 24 5/16"

MITSUBISHI	ECLIPSE	V-6, 3.8 L	2007	-	2006
------------	---------	------------	------	---	------

**21615**



1 15/32" x 1 25/32" x 20 13/16"

JEEP	CHEROKEE	4 CIL, 2.5 L	1998	-	1998
JEEP	CHEROKEE	6 CIL, 4.0 L	2001	-	1996
JEEP	GRAND CHEROKEE	6 CIL, 4.0 L	2000	-	1999

**21623**



1 15/32" x 1 1/2" x 16 19/32"

FORD	RANGER F-100	V-6, 4.0 L	1997	-	1993
------	--------------	------------	------	---	------

## Aplicación por Producto

**21631**



1 1/2" x 1 3/4" x 30 13/16"

FORD	F-350 XL	V-8, 5.0 L	1994	-	1993
------	----------	------------	------	---	------

**21634**



1 5/16" x 1 1/2" x 3 19/32"

MERCURY	SABLE / TAURUS	V-6, 3.0 L	1996	-	1996
---------	----------------	------------	------	---	------

**21639**



1 1/4" x 1 1/2" x 29 3/32"

CHRYSLER	PHANTOM	4 CIL, 2.5 L	1993	-	1993
----------	---------	--------------	------	---	------

**21642**



1 1/2" x 13 11/16"

CADILLAC	DEVILLE	V-8, 4.9 L	1994	-	1994
----------	---------	------------	------	---	------

**21660**



1 1/2" x 15 3/32"

BMW	740I	V-8, 4.4 L	2001	-	1999
-----	------	------------	------	---	------

BMW	540I	V-8, 4.4 L	2001	-	1999
BMW	740IL	V-8, 4.4 L	2001	-	1999
TOYOTA	LAND CRUISER	V-8, 4.7 L	2007	-	2003

**21667**



1 1/8" x 1 5/16" x 5 29/32"

CHEVROLET	AVEO	4 CIL, 1.6 L	2008	-	2008
CHEVROLET	AVEO	4 CIL, 1.6 L	2009	-	2009
PONTIAC	G3	4 CIL, 1.6 L	2008	-	2006

**21668**



1 1/2" x 1 3/4" x 19 11/16"

FORD	F-450 SUPER DUTY	V-8, 7.5 L	1997	-	1997
FORD	F SERIES PICKUP	V-8, 7.5 L	1997	-	1997

**21673**



1 1/2" x 19 5/16"

FORD	AEROSTAR	V-6, 3.0 L	1995	-	1993
FORD	RANGER F-100	V-6, 3.0 L	1994	-	1993

**21701**



1 1/4" x 23 1/2"

SAAB	9-3	4 CIL, 2.0 L	2003	-	1999
SAAB	9-3	4 CIL, 2.3 L	2002	-	2000

21707



1 1/4" x 37 29/32"

CHRYSLER	PT CRUISER	4 CIL, 2.4 L	2007	-	2010
----------	------------	--------------	------	---	------

21737



1 5/16" x 22"

NISSAN	240SX	4 CIL, 2.4 L	1994	-	1993
--------	-------	--------------	------	---	------

21710



1 1/2" x 1 3/4" x 26 1/2"

CHEVROLET	C y K SERIES PICKUP	V-8, 5.0 L	1999	-	1999
-----------	---------------------	------------	------	---	------

21739



5/8" x 5 11/16"

JEEP	LIBERTY	V-6, 3.7 L	2007	-	2005
------	---------	------------	------	---	------

21717



1 1/2" x 1 23/32" x 22 1/2"

CHEVROLET	EXPRESS CARGO VAN	V-8, 5.7 L	2000	-	1999
CHEVROLET	EXPRESS	V-8, 5.0 L	1999	-	1999
CHEVROLET	C y K SERIES PICKUP	V-8, 8.1 L	2002	-	2001
CHEVROLET	C y K SERIES PICKUP	V-8, 7.4 L	2000	-	1999
CHEVROLET	EXPRESS	V-8, 5.7 L	1999	-	1999
CHEVROLET	EXPRESS VAN PASAJEROS	V-8, 5.7 L	2000	-	1998

21744



1 5/16" x 12 11/16"

MITSUBISHI	MONTERO SPORT	V-6, 3.5 L	2004	-	2004
------------	---------------	------------	------	---	------

21752



1 1/4" x 19 3/32"

CHEVROLET	S-10	4 CIL, 2.2 L	1997	-	1995
-----------	------	--------------	------	---	------

21735



1 1/2" x 8 5/16"

MERCURY	SABLE / TAURUS	V-6, 3.8 L	1995	-	1993
---------	----------------	------------	------	---	------

21753



1 1/4" x 36"

CHEVROLET	S-10	4 CIL, 2.2 L	1994	-	1994
-----------	------	--------------	------	---	------

21755



1 1/4" x 1 3/8" x 25 13/16"

NISSAN	MAXIMA	V-6, 3.0 L	2004	-	2004
--------	--------	------------	------	---	------

21759



1 1/4" x 30 29/32"

CADILLAC	DEVILLE	V-8, 4.9 L	1995	-	1994
----------	---------	------------	------	---	------

21763



1 1/4" x 11 13/32"

DODGE	NEON	4 CIL, 2.0 L	1999	-	1999
NISSAN	SENTRA	4 CIL, 2.0 L	1999	-	1999

21777



1 1/4" x 1 3/8" x 27 3/16"

CHRYSLER	LEBARON	V-6, 3.0 L	1995	-	1993
----------	---------	------------	------	---	------

21784



7/16" x 4 5/16"

CHRYSLER	LEBARON	V-6, 3.0 L	1995	-	1993
----------	---------	------------	------	---	------

21793



1 1/16" x 19"

NISSAN	SENTRA	4 CIL, 1.6 L	1999	-	1999
--------	--------	--------------	------	---	------

21794



1 1/2" x 20 1/2"

FORD	MUSTANG	V-8, 4.6 L	2001	-	1999
------	---------	------------	------	---	------

21821



1 3/16" x 1 7/16" x 21 29/32"

JEEP	CHEROKEE	6 CIL, 4.0 L	2001	-	1996
JEEP	GRAND CHEROKEE	6 CIL, 4.0 L	2000	-	1999

21832



19/32" x 23/32" x 18"

## Aplicación por Producto

CHRYSLER	300 C	V-6, 3.5 L	2006	-	2005
----------	-------	------------	------	---	------

**21875**

**21834**



1 3/8" x 1 17/32" x 26 1/2"

FORD	AEROSTAR	V-6, 3.0 L	1995	-	1993
------	----------	------------	------	---	------

**21837**



1 1/4" x 1 3/8" x 22"

NISSAN	SENTRA	4 CIL, 2.0 L	1999	-	1999
--------	--------	--------------	------	---	------

**21866**



1 11/32" x 1 9/16" x 9 3/32"

NISSAN	300ZX	V-6, 3.0 L	1996	-	1993
--------	-------	------------	------	---	------

**21871**



1 3/16" x 27 19/32"

HONDA	CR-V	4 CIL, 2.0 L	2001	-	1999
-------	------	--------------	------	---	------



1 3/4" x 15 13/32"

FORD	F SERIES PICKUP	V-8, 7.5 L	1997	-	1997
FORD	F-450 SUPER DUTY	V-8, 7.5 L	1997	-	1997

**21878**



1 11/32" x 1 9/16" x 41 5/16"

NISSAN	300ZX	V-6, 3.0 L	1996	-	1993
--------	-------	------------	------	---	------

**21881**



1 1/4" x 16 3/32"

VOLKSWAGEN	PASSAT	4 CIL, 2.0 L	1993	-	1993
------------	--------	--------------	------	---	------

**21885**



1 1/4" x 1 1/2" x 16 13/32"

CHEVROLET	REGAL	V-6, 3.8 L	1995	-	1994
-----------	-------	------------	------	---	------

**21897**



1 1/4" x 1 3/8" x 26"



## Aplicación por Producto

FORD	RANGER F-100	V-6, 4.0 L	1994	-	1993
------	--------------	------------	------	---	------

**21914**

**21906**



1 1/4" x 33"

CADILLAC	DEVILLE	V-8, 4.9 L	1993	-	1993
----------	---------	------------	------	---	------

**21909**



1 11/16" x 1 25/32" x 3 19/32"

FORD	F-450 SUPER DUTY	V-8, 7.5 L	1997	-	1997
FORD	F SERIES PICKUP	V-8, 7.5 L	1997	-	1997

**21911**



1 7/32" x 6 19/32"

CHEVROLET	MALIBU	4 CIL, 2.2 L	2007	-	2007
-----------	--------	--------------	------	---	------

**21912**



1 1/2" x 25 1/2"

DODGE	RAM WAGON 2500	V-8, 5.2 L	1997	-	1996
DODGE	RAM WAGON 1500	V-8, 5.2 L	1997	-	1996



1 3/8" x 1 9/16" x 8 3/32"

NISSAN	300ZX	V-6, 3.0 L	1996	-	1993
--------	-------	------------	------	---	------

**21918**



1 1/16" x 11 11/16"

NISSAN	SENTRA	4 CIL, 1.6 L	1999	-	1999
--------	--------	--------------	------	---	------

**21921**



1 11/32" x 25 13/16"

NISSAN	240SX	4 CIL, 2.4 L	1998	-	1993
--------	-------	--------------	------	---	------

**21922**



1 3/8" x 1 3/4" x 17"

FORD	ESCORT	4 CIL, 2.0 L	2002	-	1997
FORD	ESCORT	4 CIL, 1.9 L	1996	-	1994

**21927**



1 15/32" x 1 15/32" x 31/32" x 46 31/32"

## Aplicación por Producto

LINCOLN	TOWN CAR	V-8, 4.6 L	1997 - 1993
MERCURY	GRAND MARQUIS	V-8, 4.6 L	1997 - 1993
FORD	CROWN VICTORIA	V-8, 4.6 L	1997 - 1993

### 21956



1 3/4" x 20 1/2"

DODGE	RAM MAXI VAN 3500	V-8, 5.9 L	1997 - 1997
DODGE	RAM MAXI WAGON 3500	V-8, 5.2 L	1996 - 1995
DODGE	RAM MAXI WAGON 3500	V-8, 5.9 L	1997 - 1995
DODGE	RAM WAGON 1500	V-6, 3.9 L	1997 - 1995
DODGE	RAM CHARGER	V-8, 5.2 L	1994 - 1993
DODGE	RAM WAGON 2500	V-8, 5.9 L	1995 - 1994
DODGE	RAM CHARGER	V-8, 5.9 L	1993 - 1993
DODGE	RAM WAGON 1500	V-8, 5.2 L	1997 - 1996
DODGE	RAM WAGON 2500	V-8, 5.2 L	1997 - 1996

### 21960



1 3/8" x 1 17/32" x 25 3/32"

FORD	RANGER F-100	V-6, 3.0 L	1994 - 1993
------	--------------	------------	-------------

### 21964



1 3/16" x 20"

HYUNDAI	VERNA	4 CIL, 1.5 L	2006 - 2004
---------	-------	--------------	-------------

### 21965



1 11/32" x 1 9/16" x 24 3/16"

NISSAN	MAXIMA	V-6, 3.0 L	2004 - 1993
--------	--------	------------	-------------

### 21941



1 17/32" x 1 25/32" x 37"

CADILLAC	ESCALADE	V-8, 5.7 L	2000 - 1999
CHEVROLET	C y K SERIES PICKUP	V-8, 5.0 L	1999 - 1999
CHEVROLET	SUBURBAN	V-8, 5.7 L	1999 - 1999
CHEVROLET	C-2500	V-8, 5.7 L	2000 - 1993
CHEVROLET	C y K SERIES PICKUP	V-8, 5.7 L	2000 - 1993
CHEVROLET	C-3500	V-8, 5.7 L	2000 - 1994

### 21947



1 3/16" x 1 3/8" x 22 3/16"

FORD	RANGER	4 CIL, 2.3 L	2007 - 2009
------	--------	--------------	-------------

### 21948



1 5/16" x 16 13/32"

PONTIAC	BONNEVILLE	V-6, 3.8 L	1994 - 1994
OLDSMOBILE	SILHOUETTE	V-6, 3.8 L	1995 - 1993

### 21954



1 1/2" x 24 29/32"

DODGE	RAM CHARGER	V-8, 5.2 L	1994 - 1993
-------	-------------	------------	-------------

## Aplicación por Producto

21966



1 3/8" x 1 9/16" x 23 3/32"

NISSAN	MAXIMA	V-6, 3.0 L	2004	-	1993
--------	--------	------------	------	---	------

21970



1 1/4" x 1 1/2" x 20 29/32"

JEEP	GRAND CHEROKEE	6 CIL, 4.0 L	1998	-	1994
------	----------------	--------------	------	---	------

21971



1 1/2" x 1 3/4" x 17 3/16"

JEEP	GRAND CHEROKEE	6 CIL, 4.0 L	1998	-	1994
------	----------------	--------------	------	---	------

21974



1 1/2" x 16 13/32"

LINCOLN	MARK VIII	V-8, 4.6 L	1998	-	1994
---------	-----------	------------	------	---	------

21991



1 9/32" x 16 13/32"

CHEVROLET	VENTURE	V-6, 3.4 L	2002	-	1997
-----------	---------	------------	------	---	------

CHEVROLET	LUMINA	V-6, 3.1 L	1998	-	1998
-----------	--------	------------	------	---	------

21995



1 23/32" x 22"

JEEP	GRAND CHEROKEE	V-8, 5.9 L	1998	-	1998
------	----------------	------------	------	---	------

JEEP	GRAND CHEROKEE	V-8, 5.2 L	1998	-	1994
------	----------------	------------	------	---	------

21998



1 1/2" x 24 19/32"

JEEP	GRAND CHEROKEE	V-8, 5.9 L	1998	-	1998
------	----------------	------------	------	---	------

JEEP	GRAND CHEROKEE	V-8, 5.2 L	1998	-	1994
------	----------------	------------	------	---	------

22000



1 1/4" x 1 3/8" x 16 13/16"

CHRYSLER	CONCORDE	V-6, 3.3 L	1996	-	1993
----------	----------	------------	------	---	------

22001

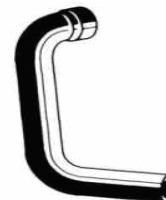

1 1/4" x 1 1/2" x 16 3/16"

CHRYSLER	CONCORDE	V-6, 3.3 L	1996	-	1993
----------	----------	------------	------	---	------

22002



1 1/4" x 1 11/32" x 20 29/32"

CHRYSLER	CONCORDE	V-6, 3.5 L	1997	-	1993
CHRYSLER	NEW YORKER	V-6, 3.5 L	1997	-	1994

22020



1 7/16" x 27 3/32"

FORD	MUSTANG	V-8, 4.6 L	1996	-	1996
------	---------	------------	------	---	------

22003



1 1/4" x 1 1/2" x 44 19/32"

CHRYSLER	TOWN & COUNTRY	V-6, 3.8 L	1995	-	1994
CHRYSLER	GRAND VOYAGER	V-6, 3.8 L	1995	-	1994
DODGE	ADVENTURER	V-6, 3.3 L	1995	-	1993

22026



1 5/16" x 24 29/32"

HYUNDAI	VERNA	4 CIL, 1.6 L	2006	-	2005
---------	-------	--------------	------	---	------

22006



1 1/2" x 17 29/32"

CHRYSLER	GRAND VOYAGER	V-6, 3.8 L	1995	-	1994
CHRYSLER	TOWN & COUNTRY	V-6, 3.8 L	1995	-	1994
DODGE	ADVENTURER	V-6, 3.3 L	1995	-	1993

22028



1 11/32" x 21 19/32"

NISSAN	QUEST	V-6, 3.3 L	2001	-	1999
NISSAN	QUEST	V-6, 3.0 L	1998	-	1997
NISSAN	QUEST	6 CIL, 3.3 L	2002	-	2002

22019



1 1/4" x 1 1/2" x 15 29/32"

OLDSMOBILE	SILHOUETTE	V-6, 3.1 L	1994	-	1993
------------	------------	------------	------	---	------

22037



1 1/4" x 21 3/16"

CHEVROLET	S-10	4 CIL, 2.2 L	2003	-	1995
-----------	------	--------------	------	---	------

### 22038



15/16" x 4 1/2"

DODGE	RAM 2500	V-8, 5.9 L	2002	-	1994
DODGE	RAM 3500	V-8, 5.9 L	2002	-	2002
DODGE	RAM MAXI VAN 2500	V-8, 5.2 L	2002	-	1996
DODGE	RAM 1500	V-6, 3.9 L	2000	-	1994
DODGE	RAM MAXI VAN 3500	V-8, 5.9 L	2002	-	1997
DODGE	RAM CHARGER	V-8, 5.9 L	2001	-	1993
JEEP	GRAND CHEROKEE	V-8, 5.2 L	1998	-	1994
DODGE	RAM MAXI WAGON 3500	V-8, 5.9 L	2002	-	1995
JEEP	GRAND CHEROKEE	V-8, 5.9 L	1998	-	1998
DODGE	RAM 2500	V-8, 5.2 L	2000	-	1995
DODGE	RAM 4000	V-8, 5.9 L	2002	-	2002
DODGE	RAM MAXI WAGON 3500	V-8, 5.2 L	1996	-	1995
DODGE	DURANGO	V-8, 5.9 L	2003	-	1998
DODGE	RAM MAXI VAN 1500	V-6, 3.9 L	2002	-	2002
DODGE	DURANGO	V-6, 3.9 L	1999	-	1998
DODGE	DURANGO	V-8, 5.2 L	2000	-	1998
DODGE	RAM WAGON 2500	V-8, 5.9 L	1995	-	1994
DODGE	RAM WAGON 3500	V-8, 5.9 L	2002	-	2002
DODGE	RAM WAGON 1500	V-8, 5.2 L	2000	-	1996
DODGE	RAM WAGON 2500	V-8, 5.2 L	2001	-	1996
FORD	EXPLORER SPORT TRAC	V-6, 4.0 L	2007	-	2009
FORD	MUSTANG	V-6, 4.0 L	2008	-	2009
FORD	EXPLORER	V-6, 4.0 L	2007	-	2009
DODGE	RAM SERIES PICKUP	V-6, 3.9 L	2001	-	1994
DODGE	RAM SERIES PICKUP	V-8, 5.9 L	2002	-	1994
DODGE	RAM WAGON 1500	V-6, 3.9 L	2001	-	2001
DODGE	RAM SERIES PICKUP	V-8, 5.2 L	2001	-	1995

### 22039



1 1/2" x 1 3/4" x 17 11/16"

CHEVROLET	S-10	V-6, 4.3 L	2002	-	1993
CHEVROLET	BLAZER	V-6, 4.3 L	2005	-	1993

### 22040



1 1/4" x 1 15/32" x 23 3/32"

OLDSMOBILE	SILHOUETTE	V-6, 3.8 L	1995	-	1993
------------	------------	------------	------	---	------

### 22042



1 3/4" x 23 5/16"

FORD	MUSTANG	V-6, 3.8 L	2001	-	1996
------	---------	------------	------	---	------

### 22043



1 7/16" x 36 3/16"

DODGE	RAM 3500	V-8, 5.9 L	2002	-	2002
DODGE	RAM 2500	V-8, 5.9 L	2002	-	2002
DODGE	RAM SERIES PICKUP	V-8, 5.2 L	2001	-	1999
DODGE	RAM SERIES PICKUP	V-8, 5.9 L	2002	-	1999
DODGE	RAM 4000	V-8, 5.9 L	2002	-	2002

### 22044



1 7/16" x 25 19/32"

FORD	THUNDERBIRD	V-8, 4.6 L	1997	-	1994
------	-------------	------------	------	---	------



22046



1 7/32" x 1 7/32" x 11/32" x 14 27/32"

PONTIAC	TRANS AM FIREBIRD	V-8, 5.7 L	1995	-	1995
---------	-------------------	------------	------	---	------

22054



1 9/32" x 19 5/16"

CHEVROLET	REGAL	V-6, 3.8 L	1995	-	1994
-----------	-------	------------	------	---	------

22047



1 5/32" x 1 3/8" x 19 13/32"

FORD	RANGER F-100	4 CIL, 2.3 L	1994	-	1993
------	--------------	--------------	------	---	------

22063



1 1/16" x 11 1/2"

NISSAN	QUEST	V-6, 3.3 L	2001	-	1999
--------	-------	------------	------	---	------

NISSAN	QUEST	V-6, 3.0 L	1998	-	1997
--------	-------	------------	------	---	------

NISSAN	QUEST	6 CIL, 3.3 L	2002	-	2002
--------	-------	--------------	------	---	------

22048



1 5/16" x 20 13/32"

CHEVROLET	TRACKER	V-6, 2.5 L	2004	-	2002
-----------	---------	------------	------	---	------

SUZUKI	GRAND VITARA	V-6, 2.5 L	2005	-	2004
--------	--------------	------------	------	---	------

22065



1 5/16" x 1 5/16" x 23/32" x 17 3/16"

PONTIAC	GRAND AM	4 CIL, 2.4 L	1998	-	1998
---------	----------	--------------	------	---	------

22052



1 9/32" x 20 5/16"

CHEVROLET	LUMINA	V-6, 3.1 L	1998	-	1998
-----------	--------	------------	------	---	------

CHEVROLET	REGAL	V-6, 3.8 L	1996	-	1996
-----------	-------	------------	------	---	------

22066



1 15/32" x 1 1/2" x 37 3/16"

DODGE	RAM SERIES PICKUP	V-6, 3.9 L	2001	-	1999
-------	-------------------	------------	------	---	------

22067



1 15/16" x 20 3/16"

DODGE	RAM SERIES PICKUP	V-10, 8.0 L	2002	-	1999
DODGE	RAM RUNNER	V-10, 8.0 L	2000	-	1995

22068



2" x 35 1/2"

DODGE	RAM SERIES PICKUP	V-10, 8.0 L	2002	-	1999
DODGE	RAM RUNNER	V-10, 8.0 L	2000	-	1995

22069



1 7/32" x 1 15/32" x 23 13/16"

JEEP	CHEROKEE	4 CIL, 2.5 L	1997	-	1996
------	----------	--------------	------	---	------

22073



1 11/32" x 13 13/16"

INFINITI	INFINITI Q45	V-8, 4.1 L	2001	-	1998
----------	--------------	------------	------	---	------

22079



1 17/32" x 13 11/16"

CADILLAC	EL DORADO	V-8, 4.6 L	2002	-	1994
CADILLAC	SEVILLE	V-8, 4.6 L	1999	-	1994
CADILLAC	DEVILLE	V-8, 4.6 L	1999	-	1999

22080



1 1/4" x 40"

CADILLAC	EL DORADO	V-8, 4.6 L	2002	-	1999
CADILLAC	DEVILLE	V-8, 4.6 L	2000	-	1997
CADILLAC	SEVILLE	V-8, 4.6 L	1999	-	1994

22081



1 3/4" x 29 11/16"

DODGE	RAM SERIES PICKUP	6 CIL, 5.9 L Diesel	1999	-	1999
-------	-------------------	---------------------	------	---	------

22082

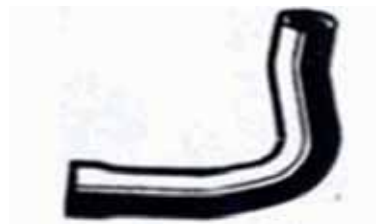

1 15/16" x 2 1/4" x 18 13/32"

DODGE	RAM SERIES PICKUP	6 CIL, 5.9 L Diesel	2002	-	1999
-------	-------------------	---------------------	------	---	------

22083



1 23/32" x 25 1/2"

DODGE	RAM SERIES PICKUP	V-8, 5.2 L	2001	-	1999
DODGE	RAM SERIES PICKUP	V-8, 5.9 L	2002	-	1999
DODGE	RAM 3500	V-8, 5.9 L	2002	-	2002
DODGE	RAM 4000	V-8, 5.9 L	2002	-	2002
DODGE	RAM 2500	V-8, 5.9 L	2002	-	2002

22094



1 1/4" x 1 5/16" x 23/32" x 16 13/16"

PONTIAC	GRAND AM	V-6, 3.1 L	1998	-	1997
---------	----------	------------	------	---	------

22105



1 25/32" x 2 1/8" x 25/32" x 30 3/32"

CHEVROLET	C y K SERIES PICKUP	V-8, 6.5 L	2002	-	1999
-----------	---------------------	------------	------	---	------

22086



1 17/32" x 1 25/32" x 30 3/16"

CHEVROLET	C y K SERIES PICKUP	V-6, 4.3 L	1998	-	1995
CHEVROLET	C-1500	V-6, 4.3 L	1998	-	1995

22109



1 5/16" x 1 5/16" x 23/32" x 18 3/32"

CHEVROLET	CAVALIER	4 CIL, 2.2 L	1995	-	1995
-----------	----------	--------------	------	---	------

22087



1 9/32" x 28 3/32"

CHEVROLET	BLAZER	V-6, 4.3 L	1995	-	1993
-----------	--------	------------	------	---	------

22118



1 1/4" x 1 15/32" x 19 13/16"

DODGE	NEON	4 CIL, 2.0 L	1999	-	1999
-------	------	--------------	------	---	------

22090



1 7/32" x 10 29/32"

PONTIAC	MONTANA	V-6, 3.9 L	2008	-	2006
CHEVROLET	UPLANDER	V-6, 3.9 L	2007	-	2009

22119



1 1/4" x 13 13/32"

DODGE	NEON	4 CIL, 2.0 L	1999	-	1999
-------	------	--------------	------	---	------

22120



1 1/4" x 13 13/32"

DODGE	NEON	4 CIL, 2.0 L	1999	-	1995
-------	------	--------------	------	---	------

22126



1 1/4" x 13 19/32"

DODGE	STRATUS	4 CIL, 2.4 L	2000	-	1995
CHRYSLER	CIRRUS	4 CIL, 2.4 L	2000	-	1995
CHRYSLER	SEBRING	4 CIL, 2.4 L	1999	-	1996

22121



1 1/4" x 1 11/32" x 29"

CHRYSLER	SEBRING	V-6, 2.5 L	2000	-	1996
DODGE	STRATUS	V-6, 2.5 L	2000	-	1995
CHRYSLER	CIRRUS	V-6, 2.5 L	2000	-	1995

22127



1 7/32" x 1 9/32" x 16 3/16"

DODGE	STRATUS	4 CIL, 2.4 L	2000	-	1995
CHRYSLER	SEBRING	4 CIL, 2.4 L	1999	-	1996
CHRYSLER	CIRRUS	4 CIL, 2.4 L	2000	-	1995

22122



1 7/16" x 21 11/16"

FORD	CROWN VICTORIA	V-8, 4.6 L	1994	-	1993
MERCURY	GRAND MARQUIS	V-8, 4.6 L	1997	-	1993
LINCOLN	TOWN CAR	V-8, 4.6 L	1994	-	1993

22128



1 1/4" x 1 5/16" x 16"

CHRYSLER	CIRRUS	4 CIL, 2.0 L	2000	-	2000
DODGE	STRATUS	4 CIL, 2.0 L	2000	-	1995

22125



1 23/32" x 28 29/32"

DODGE	RAM WAGON 1500	V-6, 3.9 L	2001	-	2001
DODGE	RAM SERIES PICKUP	V-6, 3.9 L	2001	-	1998
DODGE	RAM MAXI VAN 1500	V-6, 3.9 L	1999	-	1995
DODGE	RAM 1500	V-6, 3.9 L	2000	-	1998

22129



1 1/4" x 14 19/32"

CHEVROLET	COLORADO	5 CIL, 3.7 L	2007	-	2010
HUMMER	H3	5 CIL, 3.5 L	2007	-	2006
CHEVROLET	COLORADO	5 CIL, 3.5 L	2006	-	2004
CHEVROLET	COLORADO	5 CIL, 3.5 L	2005	-	2005
CHRYSLER	CIRRUS	4 CIL, 2.0 L	2000	-	2000
HUMMER	H3	5 CIL, 3.7 L	2008	-	2010

## Aplicación por Producto

DODGE	STRATUS	4 CIL, 2.0 L	2000	-	1995
GMC	CANYON	5 CIL, 3.7 L	2008	-	2010

**22139**



1 1/2" x 18 3/32"

OLDSMOBILE	EIGHTY EIGHT	V-6, 3.8 L	1999	-	1998
PONTIAC	BONNEVILLE	V-6, 3.8 L	2000	-	1996

**22130**



1 5/16" x 24 1/2"

CHRYSLER	SEBRING	V-6, 2.5 L	2000	-	1997
----------	---------	------------	------	---	------

**22143**



1 23/32" x 21 3/32"

FORD	F-350 SUPER DUTY	V-8, 5.8 L	1997	-	1997
------	------------------	------------	------	---	------

**22131**



1 3/16" x 19 19/32"

LINCOLN	MARK VIII	V-8, 4.6 L	1998	-	1994
---------	-----------	------------	------	---	------

**22144**



1 7/16" x 28 29/32"

FORD	RANGER	V-6, 3.0 L	2002	-	1996
FORD	RANGER F-100	V-6, 3.0 L	2001	-	1998

**22132**



1 7/16" x 14 3/32"

LINCOLN	MARK VIII	V-8, 4.6 L	1998	-	1994
---------	-----------	------------	------	---	------

**22147**



1 5/16" x 23 11/16"

NISSAN	QUEST	V-6, 3.0 L	1998	-	1997
NISSAN	QUEST	6 CIL, 3.3 L	2002	-	2002
NISSAN	QUEST	V-6, 3.3 L	2001	-	1999

**22133**



1 9/32" x 16 3/16"

OLDSMOBILE	SILHOUETTE	V-6, 3.4 L	1996	-	1996
CHEVROLET	LUMINA	V-6, 3.4 L	1996	-	1996



22148



1 5/16" x 1 5/16" x 23/32" x 14 5/16"

CHEVROLET	CAVALIER	4 CIL, 2.2 L	2000	-	1998
CHEVROLET	CAVALIER	4 CIL, 2.4 L	1999	-	1996
CHEVROLET	CAVALIER	4 CIL, 2.3 L	1995	-	1995
PONTIAC	SUNFIRE	4 CIL, 2.4 L	2002	-	1996
CHEVROLET	CAVALIER Z24	4 CIL, 2.4 L	2002	-	1995
PONTIAC	SUNFIRE	4 CIL, 2.3 L	1995	-	1995

22152



1 5/16" x 23 5/16"

PONTIAC	SUNFIRE	4 CIL, 2.4 L	2002	-	1999
PONTIAC	SUNFIRE	4 CIL, 2.3 L	1995	-	1995
CHEVROLET	CAVALIER	4 CIL, 2.4 L	1999	-	1996

22153



1 5/16" x 18 3/16"

PONTIAC	SUNFIRE	4 CIL, 2.2 L	1996	-	1996
---------	---------	--------------	------	---	------

22155



1 15/32" x 19"

FORD	RANGER	4 CIL, 2.3 L	1997	-	1996
FORD	RANGER F-100	4 CIL, 2.3 L	1997	-	1996

22156



1 15/32" x 1 1/2" x 14 3/32"

FORD	RANGER	4 CIL, 2.3 L	1997	-	1996
FORD	RANGER F-100	4 CIL, 2.3 L	1997	-	1996

22149



1 15/32" x 1 15/32" x 3/4" x 13 31/32"

FORD	THUNDERBIRD	V-8, 4.6 L	1997	-	1994
------	-------------	------------	------	---	------

22150



1 7/16" x 22 19/32"

FORD	MUSTANG	V-8, 5.0 L	1995	-	1994
------	---------	------------	------	---	------

22151



1 23/32" x 19 1/2"

FORD	MUSTANG	V-8, 5.0 L	1995	-	1994
------	---------	------------	------	---	------

## Aplicación por Producto

22157



1 15/32" x 27 5/16"

FORD	WINDSTAR	V-6, 3.8 L	1995	-	1995
------	----------	------------	------	---	------

22166



1 1/2" x 15 5/16"

FORD	EXPLORER	V-6, 4.0 L	1996	-	1995
------	----------	------------	------	---	------

22167



1 11/32" x 20"

NISSAN	SENTRA	4 CIL, 2.0 L	1999	-	1999
--------	--------	--------------	------	---	------

22169



1 17/32" x 1 25/32" x 27 3/16"

CHEVROLET	P-30	V-6, 4.3 L	1996	-	1996
-----------	------	------------	------	---	------

22178



1 1/4" x 1 11/16" x 5/8" x 5/8" x 5/8" x 14 13/32"

FORD	CONTOUR	4 CIL, 2.0 L	1997	-	1995
------	---------	--------------	------	---	------

MERCURY	MYSTIQUE	4 CIL, 2.0 L	1997	-	1995
---------	----------	--------------	------	---	------

22179



1 1/4" x 1 11/16" x 5/8" x 5/8" x 5/8" x 14 17/32"

MERCURY	MYSTIQUE	4 CIL, 2.0 L	1997	-	1995
FORD	CONTOUR	4 CIL, 2.0 L	1997	-	1995

22180



1 1/32" x 1 1/4" x 9/32" x 1 7/32" x 1 7/32" x 22 3/16"

FORD	CONTOUR	V-6, 2.5 L	2000	-	1995
MERCURY	MYSTIQUE	V-6, 2.5 L	2000	-	1995
FORD	MONDEO	V-6, 2.5 L	2003	-	2006

22183



1 11/32" x 14 13/16"

MITSUBISHI	ECLIPSE	V-6, 3.8 L	2007	-	2006
NISSAN	MAXIMA	V-6, 3.0 L	2001	-	1995
INFINITI	INFINITI I30	V-6, 3.0 L	2001	-	1998

22184



1 11/32" x 21"

INFINITI	INFINITI I30	V-6, 3.0 L	2001	-	1998
NISSAN	MAXIMA	V-6, 3.0 L	2001	-	1995

22185



1 11/32" x 17 11/16"

NISSAN	XTERRA	4 CIL, 2.4 L	2004	-	2000
NISSAN	FRONTIER	4 CIL, 2.4 L	2004	-	1999

22210



1" x 5"

CHEVROLET	C y K SERIES PICKUP	V-8, 6.5 L	2002	-	1999
CHEVROLET	EXPRESS	V-8, 6.5 L	2002	-	1999

22196

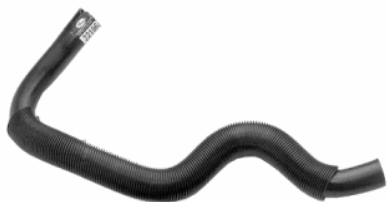

1 9/32" x 32 1/2"

CHEVROLET	S-10	V-6, 4.3 L	2002	-	1996
CHEVROLET	BLAZER	V-6, 4.3 L	2005	-	1996

22211



1 5/16" x 1 5/16" x 3/4" x 15 13/32"

PONTIAC	SUNFIRE	4 CIL, 2.2 L	1996	-	1996
CHEVROLET	CAVALIER	4 CIL, 2.2 L	1997	-	1996

22197



1 11/32" x 18 3/16"

NISSAN	240SX	4 CIL, 2.4 L	1998	-	1995
--------	-------	--------------	------	---	------

22212



1 1/4" x 1 11/32" x 14 5/16"

CHRYSLER	VOYAGER	V-6, 3.0 L	1998	-	1996
----------	---------	------------	------	---	------

22209



1 1/4" x 33 13/32"

CHEVROLET	C y K SERIES PICKUP	V-8, 5.7 L	1997	-	1996
CHEVROLET	C y K SERIES PICKUP	V-8, 5.0 L	1999	-	1999
CHEVROLET	C-2500	V-8, 5.7 L	1997	-	1996

22214



1 1/4" x 22 3/32"

HYUNDAI	VERNA	4 CIL, 1.5 L	2006	-	2004
---------	-------	--------------	------	---	------

## Aplicación por Producto

**22215**



1 1/4" x 16"

HYUNDAI	VERNA	4 CIL, 1.6 L	2006	-	2005
---------	-------	--------------	------	---	------

**22222**



1 1/2" x 14 3/32"

CHRYSLER	VOYAGER	V-6, 3.3 L	2000	-	1996
CHRYSLER	GRAND VOYAGER	V-6, 3.8 L	2000	-	2000
CHRYSLER	TOWN & COUNTRY	V-6, 3.8 L	2000	-	1996
DODGE	CARAVAN	V-6, 3.3 L	2000	-	2000
CHRYSLER	GRAND VOYAGER	V-6, 3.3 L	2000	-	1996
DODGE	ADVENTURER	V-6, 3.3 L	2000	-	1996

**22225**



1 11/32" x 1 1/2" x 41 13/32"

CHRYSLER	VOYAGER	V-6, 3.0 L	1998	-	1996
----------	---------	------------	------	---	------

**22226**



1 1/2" x 40 3/32"

CHRYSLER	GRAND VOYAGER	V-6, 3.3 L	2000	-	1996
CHRYSLER	VOYAGER	V-6, 3.3 L	2000	-	1996
CHRYSLER	VOYAGER	V-6, 3.8 L	1999	-	1999
DODGE	CARAVAN	V-6, 3.3 L	2000	-	2000
CHRYSLER	GRAND VOYAGER	V-6, 3.8 L	2000	-	2000
DODGE	ADVENTURER	V-6, 3.3 L	2000	-	1996

CHRYSLER	TOWN & COUNTRY	V-6, 3.8 L	2000	-	1996
----------	----------------	------------	------	---	------

**22227**



1 1/4" x 1 1/2" x 15 3/16"

CHRYSLER	TOWN & COUNTRY	V-6, 3.8 L	2000	-	1996
CHRYSLER	GRAND VOYAGER	V-6, 3.8 L	2000	-	2000
CHRYSLER	VOYAGER	V-6, 3.3 L	2000	-	1996
CHRYSLER	VOYAGER	V-6, 3.8 L	1999	-	1999
CHRYSLER	GRAND VOYAGER	V-6, 3.3 L	2000	-	1996
DODGE	CARAVAN	V-6, 3.3 L	2000	-	2000
DODGE	ADVENTURER	V-6, 3.3 L	2000	-	1996

**22228**



1 1/4" x 30 3/32"

CHEVROLET	C-1500	V-6, 4.3 L	1998	-	1996
CHEVROLET	C y K SERIES PICKUP	V-6, 4.3 L	1998	-	1996

**22229**



1 1/4" x 1 1/2" x 32 3/16"

CHEVROLET	C y K SERIES PICKUP	V-8, 7.4 L	2000	-	1999
-----------	---------------------	------------	------	---	------

**22233**



1 11/32" x 1 17/32" x 24"

MERCEDES BE	C230	4 CIL, 2.3 L	1999	-	1999
-------------	------	--------------	------	---	------

22234



1 11/32" x 1 17/32" x 15 11/16"

MERCEDES BE	C230	4 CIL, 2.3 L	1999	-	1999
-------------	------	--------------	------	---	------

22243



1 15/32" x 1 15/32" x 23/32" x 17 1/2"

MERCURY	SABLE / TAURUS	V-6, 3.0 L	1996	-	1996
---------	----------------	------------	------	---	------

22239



1 11/32" x 1 1/4" x 18 13/32"

MERCURY	MYSTIQUE	4 CIL, 2.0 L	2000	-	1995
FORD	CONTOUR	4 CIL, 2.0 L	2000	-	1995

22244



1 15/32" x 17 1/2"

LINCOLN	CONTINENTAL	V-8, 4.6 L	2002	-	1995
---------	-------------	------------	------	---	------

22240



1 1/16" x 1 1/4" x 8 13/32"

MERCURY	MYSTIQUE	V-6, 2.5 L	2000	-	1995
FORD	CONTOUR	V-6, 2.5 L	2000	-	1995

22245



1 7/16" x 35 3/16"

LINCOLN	CONTINENTAL	V-8, 4.6 L	2002	-	1995
---------	-------------	------------	------	---	------

22242



1 15/32" x 22 29/32"

MERCURY	SABLE / TAURUS	V-6, 3.0 L	2005	-	1996
---------	----------------	------------	------	---	------

22247



1 3/4" x 31 3/32"

CHEVROLET	C y K SERIES PICKUP	V-8, 6.5 L	2002	-	1999
-----------	---------------------	------------	------	---	------

22248



1 15/32" x 27 13/16"

FORD	MUSTANG	V-6, 3.8 L	2001	-	1996
------	---------	------------	------	---	------



**22249**

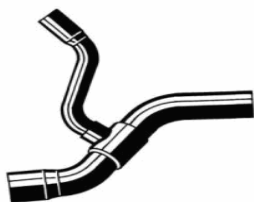

1 15/32" x 1 23/32" x 31/32" x 14 11/16"

FORD	MUSTANG	V-8, 4.6 L	2004	-	1996
------	---------	------------	------	---	------

**22253**



1 3/16" x 1 3/8" x 31 19/32"

VOLVO	V70	5 CIL, 2.3 L	2000	-	1999
VOLVO	C70 T5	5 CIL, 2.3 L	2000	-	2000
VOLVO	V70	5 CIL, 2.4 L	2000	-	1999
VOLVO	C70	5 CIL, 2.3 L	2000	-	1999
VOLVO	C70	5 CIL, 2.4 L	2000	-	1999
VOLVO	S70	5 CIL, 2.4 L	2000	-	1999
VOLVO	S70	5 CIL, 2.3 L	2000	-	1999

**22251**



1 3/16" x 1 3/8" x 14 19/32"

VOLVO	V70	5 CIL, 2.3 L	2001	-	1999
VOLVO	S70	5 CIL, 2.4 L	2000	-	1999
VOLVO	S60	5 CIL, 2.3 L	2001	-	2001
VOLVO	C70 T5	5 CIL, 2.3 L	2000	-	2000
VOLVO	V70	5 CIL, 2.4 L	2000	-	1999
VOLVO	C70	5 CIL, 2.4 L	2001	-	1999
VOLVO	S70	5 CIL, 2.3 L	2000	-	1999
VOLVO	S60	5 CIL, 2.4 L	2001	-	2001
VOLVO	C70	5 CIL, 2.3 L	2001	-	1999

**22254**



1 15/32" x 1 15/32" x 19/32" x 15 19/32"

FORD	RANGER	V-6, 3.0 L	1996	-	1996
------	--------	------------	------	---	------

**22255**



1 15/32" x 1 15/32" x 19/32" x 18 13/32"

FORD	AEROSTAR	V-6, 3.0 L	1997	-	1997
FORD	RANGER F-100	V-6, 3.0 L	1997	-	1996

**22252**



1 3/16" x 1 3/8" x 32 29/32"

VOLVO	S70	5 CIL, 2.4 L	2000	-	1999
VOLVO	V70	5 CIL, 2.4 L	2000	-	1999
VOLVO	V70	5 CIL, 2.3 L	2000	-	2000
VOLVO	C70	5 CIL, 2.4 L	2000	-	1999

**22261**



1 1/4" x 1 1/2" x 45"

CHEVROLET	CAMARO Z28	V-6, 3.8 L	2002	-	1996
-----------	------------	------------	------	---	------

22262



1 9/32" x 19 5/16"

CHEVROLET	CAMARO Z28	V-6, 3.8 L	2001	-	1996
-----------	------------	------------	------	---	------

22263



1 9/32" x 21 1/2"

CHEVROLET	CAMARO Z28	V-8, 5.7 L	1997	-	1996
PONTIAC	FIREBIRD TRANS AM	V-8, 5.7 L	1997	-	1997
PONTIAC	TRANS AM FIREBIRD	V-8, 5.7 L	1997	-	1995

22264



1 9/32" x 14 3/16"

CHEVROLET	REGAL	V-6, 3.8 L	1996	-	1996
-----------	-------	------------	------	---	------

22266



1 9/32" x 32 11/16"

CHEVROLET	P-30	V-6, 4.3 L	1996	-	1996
-----------	------	------------	------	---	------

22269



1 5/16" x 18 3/16"

VOLKSWAGEN	TOUAREG	V-8, 4.2 L	2006	-	2006
CHEVROLET	TRACKER	4 CIL, 2.0 L	2003	-	1999

22275



1 11/32" x 19 1/16" x 18 3/16"

NISSAN	PATHFINDER LE 4X2	V-6, 3.3 L	2000	-	1997
NISSAN	PATHFINDER	V-6, 3.3 L	2000	-	1998

22276



1 19/32" x 4 13/16"

NISSAN	PATHFINDER	V-6, 3.3 L	2000	-	1998
--------	------------	------------	------	---	------

22277



1 1/4" x 1 7/8" x 29/32" x 5/8" x 37 3/4"

VOLKSWAGEN	JETTA	4 CIL, 2.0 L	1994	-	1994
VOLKSWAGEN	CABRIO	4 CIL, 2.0 L	2002	-	1995
VOLKSWAGEN	GOLF	4 CIL, 2.0 L	1997	-	1997

22278



1 7/32" x 13 19/32"

VOLKSWAGEN	CABRIO	4 CIL, 2.0 L	2002	-	1995
VOLKSWAGEN	GOLF	4 CIL, 2.0 L	2001	-	1997
VOLKSWAGEN	GTI	4 CIL, 2.0 L	2000	-	1999
VOLKSWAGEN	JETTA	4 CIL, 2.0 L	2000	-	1994

22282



1 7/32" x 1 15/32" x 11 19/32"

JEEP	WRANGLER	V-6, 4.0 L	2004	-	2004
JEEP	WRANGLER	6 CIL, 4.0 L	2006	-	1997

22279



1 5/16" x 1 9/16" x 10 1/2"

VOLKSWAGEN	GOLF	4 CIL, 2.0 L	2000	-	1998
VOLKSWAGEN	JETTA	4 CIL, 2.0 L	1998	-	1998
MERCEDES BE	C280	V-6, 2.8 L	1998	-	1998

22280



1 15/32" x 1 23/32" x 26 13/32"

JEEP	WRANGLER	4 CIL, 2.4 L	2003	-	2003
JEEP	WRANGLER	4 CIL, 2.5 L	2002	-	2000

22281



1 7/32" x 1 1/4" x 19 13/16"

JEEP	WRANGLER	4 CIL, 2.5 L	2002	-	1997
JEEP	WRANGLER	4 CIL, 2.4 L	2003	-	2003

22283



1 15/32" x 1 23/32" x 13 1/2"

JEEP	WRANGLER	6 CIL, 4.0 L	1998	-	1997
------	----------	--------------	------	---	------

22284



1 3/8" x 1 15/32" x 23 11/16"

FORD	RANGER F-100	V-6, 3.0 L	1997	-	1996
FORD	AEROSTAR	V-6, 3.0 L	1997	-	1996

22286



1 15/32" x 26 29/32"

FORD	WINDSTAR	V-6, 3.8 L	2003	-	1996
------	----------	------------	------	---	------

22287



1 23/32" x 17 13/32"

DODGE	DURANGO	V-8, 5.9 L	1999	-	1998
DODGE	DURANGO	V-8, 5.2 L	1999	-	1998

22288



1 15/32" x 32 1/2"

DODGE	DURANGO	V-8, 5.2 L	1999	-	1998
DODGE	DURANGO	V-8, 5.9 L	1999	-	1998

22290



1 15/32" x 30 19/32"

DODGE	DURANGO	V-6, 3.9 L	1999	-	1998
-------	---------	------------	------	---	------

22291



1 23/32" x 1 3/4" x 23 1/2"

DODGE	DURANGO	V-6, 3.9 L	1999	-	1998
-------	---------	------------	------	---	------

22294

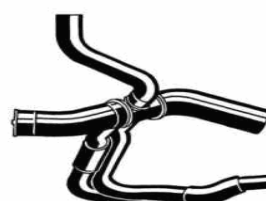

1 23/32" x 1 27/32" x 31/32" x 23/32" x 23/32" x 13

FORD	EXPEDITION	V-8, 5.4 L	2002	-	1997
------	------------	------------	------	---	------

22295

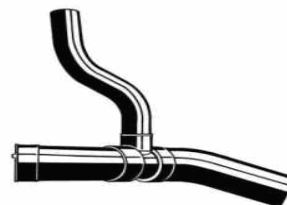

1 23/32" x 1 27/32" x 31/32" x 14 3/4"

FORD	EXPEDITION	V-8, 4.6 L	2002	-	1997
LINCOLN	NAVIGATOR	V-8, 5.4 L	2000	-	1999
FORD	EXPEDITION	V-8, 5.4 L	2002	-	1997

22297

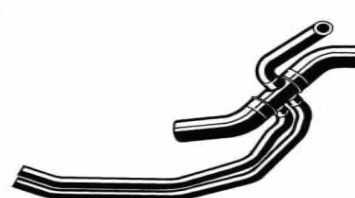

1 23/32" x 1 23/32" x 31/32" x 23/32" x 23/32" x 13

LINCOLN	NAVIGATOR	V-8, 5.4 L	2000	-	1999
FORD	EXPEDITION	V-8, 5.4 L	2002	-	1999
FORD	LOBO	V-8, 5.4 L	2003	-	2002
FORD	F SERIES PICKUP	V-8, 5.4 L	2002	-	1999
FORD	F-250 XL	V-8, 5.4 L	1999	-	1999
FORD	SUPER DUTY VAN	V-8, 4.6 L	2003	-	2003

22298



1 23/32" x 1 23/32" x 31/32" x 14 3/4"

FORD	F-250 XLT	V-8, 4.6 L	2001	-	1998
FORD	SUPER DUTY VAN	V-8, 4.6 L	2003	-	2003
FORD	F-250 XL	V-8, 4.6 L	2001	-	1998
FORD	F SERIES PICKUP	V-8, 4.6 L	2001	-	1998

## Aplicación por Producto

FORD	LOBO	V-8, 4.6 L	2000	-	1997
FORD	LOBO	V-8, 5.4 L	2003	-	2002
FORD	F SERIES PICKUP	V-8, 5.4 L	2002	-	1999

**22304**



1 1/16" x 1 15/32" x 4 13/16"

MERCURY	MYSTIQUE	V-6, 2.5 L	2000	-	1995
FORD	CONTOUR	V-6, 2.5 L	1999	-	1995

**22306**



1 5/16" x 23 29/32"

TOYOTA	CAMRY	V-6, 3.0 L	2002	-	2002
TOYOTA	SIENNA	V-6, 3.0 L	2003	-	2003

**22307**



1 15/32" x 27 13/16"

FORD	MUSTANG	V-8, 4.6 L	2001	-	1999
------	---------	------------	------	---	------

**22309**



1 5/16" x 19 3/16"

TOYOTA	SOLARA	V-6, 3.3 L	2006	-	2005
TOYOTA	CAMRY	V-6, 3.0 L	2006	-	2002
TOYOTA	SIENNA	V-6, 3.0 L	2003	-	2003

**22299**



1 23/32" x 1 23/32" x 31/32" x 24 5/8"

FORD	F SERIES PICKUP	V-6, 4.2 L	2002	-	1998
FORD	F-150	V-6, 4.2 L	2007	-	1998

**22301**



1 23/32" x 24 3/32"

FORD	F-150	V-6, 4.2 L	2007	-	1998
FORD	F SERIES PICKUP	V-6, 4.2 L	2002	-	1998

**22302**

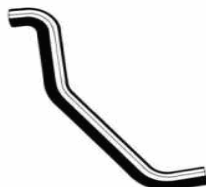

1 23/32" x 29 3/32"

FORD	EXPEDITION	V-8, 5.4 L	2002	-	1997
FORD	EXPEDITION	V-8, 4.6 L	2002	-	1997
FORD	F-250 XL	V-8, 5.4 L	1999	-	1999
FORD	LOBO	V-8, 4.6 L	2000	-	1997
FORD	F-250 XLT	V-8, 4.6 L	2001	-	1998
FORD	F-250 XL	V-8, 4.6 L	2001	-	1998
FORD	F SERIES PICKUP	V-8, 4.6 L	2001	-	1998
LINCOLN	NAVIGATOR	V-8, 5.4 L	2000	-	1999
FORD	LOBO	V-8, 5.4 L	2003	-	2002
FORD	F SERIES PICKUP	V-8, 5.4 L	2002	-	1999



22310



1 15/32" x 23 11/16"

FORD	EXPLORER	V-8, 5.0 L	2001	-	1998
------	----------	------------	------	---	------

22311



1 15/32" x 1 23/32" x 11 13/32"

FORD	EXPLORER	V-8, 5.0 L	1998	-	1998
------	----------	------------	------	---	------

22312



1 23/32" x 24 19/32"

FORD	E SERIES VAN	V-8, 7.3 L	2001	-	1997
------	--------------	------------	------	---	------

FORD	SUPER DUTY VAN	V-8, 7.3 L	2001	-	1999
------	----------------	------------	------	---	------

22314



1 23/32" x 26 11/16"

FORD	E SERIES VAN	V-6, 4.2 L	2003	-	1997
------	--------------	------------	------	---	------

FORD	SUPER DUTY VAN	V-6, 4.2 L	2001	-	2001
------	----------------	------------	------	---	------

22315



1 23/32" x 20 19/32"

FORD	E SERIES VAN	V-8, 4.6 L	2006	-	1999
------	--------------	------------	------	---	------

FORD	E SERIES VAN	V-8, 5.4 L	2007	-	1997
------	--------------	------------	------	---	------

FORD	SUPER DUTY VAN	V-8, 4.6 L	2003	-	2003
------	----------------	------------	------	---	------

FORD	SUPER DUTY VAN	V-8, 5.4 L	2001	-	1999
------	----------------	------------	------	---	------

22316



1 23/32" x 20 3/16"

FORD	SUPER DUTY VAN	V-10, 6.8 L	2001	-	1999
------	----------------	-------------	------	---	------

FORD	E SERIES VAN	V-8, 5.4 L	1999	-	2010
------	--------------	------------	------	---	------

FORD	E SERIES VAN	V-8, 4.6 L	2008	-	2010
------	--------------	------------	------	---	------

22317



1 23/32" x 1 23/32" x 31/32" x 39 7/32"

FORD	E SERIES VAN	V-6, 4.2 L	2001	-	1997
------	--------------	------------	------	---	------

22318



1 23/32" x 1 23/32" x 31/32" x 23/32" x 23/32" x 34

FORD	SUPER DUTY VAN	V-8, 5.4 L	2001	-	1999
------	----------------	------------	------	---	------

FORD	E SERIES VAN	V-8, 5.4 L	2001	-	1997
------	--------------	------------	------	---	------

## Aplicación por Producto

**22319**



1 23/32" x 1 23/32" x 31 3/32" x 26 3/16"

FORD	E SERIES VAN	V-8, 7.3 L	2001	-	1997
FORD	SUPER DUTY VAN	V-8, 7.3 L	2001	-	1999

**22322**



1 3/16" x 14 5/16"

HONDA	CR-V	4 CIL, 2.0 L	2001	-	1999
-------	------	--------------	------	---	------

**22323**



1 1/32" x 29 29/32"

HONDA	CIVIC	4 CIL, 1.6 L	2000	-	1997
-------	-------	--------------	------	---	------

**22328**



1 1/4" x 20 13/32"

PONTIAC	BONNEVILLE	V-6, 3.8 L	2005	-	2000
---------	------------	------------	------	---	------

**22329**



1 17/32" x 17 11/16"

PONTIAC	BONNEVILLE	V-6, 3.8 L	2005	-	2000
---------	------------	------------	------	---	------

**22331**



1 5/16" x 23 19/32"

PONTIAC	GRAND AM	4 CIL, 2.4 L	2001	-	1999
---------	----------	--------------	------	---	------

**22332**



1 5/16" x 19 3/32"

CHEVROLET	MALIBU	V-6, 3.1 L	2003	-	1998
PONTIAC	GRAND AM	V-6, 3.4 L	2005	-	1999

**22334**



1 5/16" x 1 5/16" x 3/4" x 13 31/32"

PONTIAC	GRAND AM	V-6, 3.4 L	1999	-	1999
CHEVROLET	MALIBU	V-6, 3.1 L	2000	-	1999

**22335**



1 3/16" x 21 13/16"

TOYOTA	COROLLA	4 CIL, 1.8 L	2002	-	2002
--------	---------	--------------	------	---	------

## Aplicación por Producto

22337

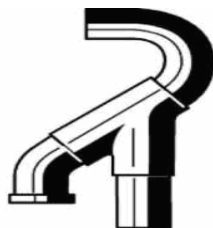

1 1/4" x 1 1/4" x 1 1/2" x 5/16" x 15 3/8"

MERCURY	SABLE / TAURUS	V-6, 3.0 L	1999	-	1996
---------	----------------	------------	------	---	------

22338



1 3/16" x 15 29/32"

HONDA	ACCORD	4 CIL, 2.3 L	2002	-	1998
-------	--------	--------------	------	---	------

22339



1 3/16" x 35 3/16"

HONDA	ACCORD	4 CIL, 2.3 L	2002	-	1998
-------	--------	--------------	------	---	------

22340



1 3/16" x 19 3/32"

HONDA	ACCORD	V-6, 3.0 L	2002	-	1998
-------	--------	------------	------	---	------

22341



1 3/16" x 26"

HONDA	ACCORD	V-6, 3.0 L	2002	-	1998
-------	--------	------------	------	---	------

HONDA	ODYSSEY	V-6, 3.5 L	2002	-	1999
-------	---------	------------	------	---	------

22342



1 5/16" x 20 5/16"

CHEVROLET	CAVALIER	4 CIL, 2.2 L	2002	-	1998
PONTIAC	SUNFIRE	4 CIL, 2.2 L	2002	-	1998

22343



1 5/16" x 1 5/16" x 23 32" x 15 11/32"

CHEVROLET	CAVALIER	4 CIL, 2.2 L	2002	-	1999
PONTIAC	SUNFIRE	4 CIL, 2.2 L	2002	-	1998

22344



1 1/4" x 21 3/16"

CHEVROLET	IMPALA	V-6, 3.8 L	2003	-	2000
PONTIAC	GRAND PRIX	V-6, 3.1 L	2002	-	1997
CHEVROLET	IMPALA	V-6, 3.4 L	2002	-	2000
PONTIAC	GRAND PRIX	V-6, 3.8 L	2003	-	1997

22345



1 1/4" x 15 1/2"

PONTIAC	SUNFIRE	4 CIL, 2.2 L	2005	-	2002
CHEVROLET	CAVALIER	4 CIL, 2.2 L	2005	-	2002
PONTIAC	GRAND PRIX	V-6, 3.1 L	2002	-	1997
CHEVROLET	IMPALA	V-6, 3.4 L	2002	-	2000

22346



1 11/32" x 11 3/16"

FORD	ZX2	4 CIL, 2.0 L	2002	-	2001
FORD	ESCORT	4 CIL, 2.0 L	2001	-	1998

22351



1 15/32" x 1 15/32" x 19/32" x 17 5/16"

FORD	RANGER	V-6, 3.0 L	2002	-	1998
FORD	RANGER F-100	V-6, 3.0 L	2001	-	1998

22347



1 11/32" x 13 19/32"

FORD	ESCORT	4 CIL, 2.0 L	2001	-	1998
FORD	ZX2	4 CIL, 2.0 L	2002	-	2001

22352



1 9/32" x 24 3/16"

PONTIAC	FIREBIRD TRANS AM	V-8, 5.7 L	2002	-	1999
CHEVROLET	CAMARO Z28	V-8, 5.7 L	2002	-	1999

22349



1 15/32" x 26 1/2"

FORD	RANGER F-100	V-6, 4.0 L	2001	-	1998
FORD	RANGER	V-6, 4.0 L	2000	-	1999

22353



1 9/32" x 8 1/2"

CHEVROLET	CAMARO Z28	V-8, 5.7 L	2002	-	1998
NISSAN	ALTIMA	V-6, 3.5 L	2008	-	2007
NISSAN	ALTIMA	4 CIL, 2.5 L	2007	-	2007
PONTIAC	TRANS AM FIREBIRD	V-8, 5.7 L	2000	-	1998
PONTIAC	FIREBIRD TRANS AM	V-8, 5.7 L	2002	-	1999

22350

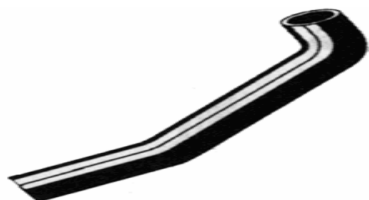

1 15/32" x 15 1/2"

FORD	RANGER	V-6, 4.0 L	2001	-	1999
FORD	RANGER F-100	V-6, 4.0 L	2001	-	1998

22354



1 9/32" x 14 29/32"

PONTIAC	FIREBIRD TRANS AM	V-8, 5.7 L	2002	-	1999
CHEVROLET	CAMARO Z28	V-8, 5.7 L	2002	-	1998
PONTIAC	TRANS AM FIREBIRD	V-8, 5.7 L	2000	-	1998

22356



1 9/32" x 19 5/16"

CHEVROLET	S-10	4 CIL, 2.2 L	2003	-	1998
-----------	------	--------------	------	---	------

22357



CORTAR A MEDIDA

1 9/32" x 32 3/16"

CHRYSLER	CIRRUS	4 CIL, 2.4 L	2005	-	2005
CHEVROLET	EXPRESS VAN PASAJEROS	V-8, 5.7 L	2000	-	1998
CHEVROLET	EXPRESS CARGO VAN	V-8, 5.7 L	2000	-	1999
CHEVROLET	EXPRESS	V-8, 5.7 L	2002	-	1999
CHEVROLET	EXPRESS	V-8, 5.0 L	2002	-	1999
DODGE	STRATUS	4 CIL, 2.4 L	2006	-	2001

22358



1 1/4" x 36 3/16"

CHEVROLET	SUBURBAN	V-8, 5.7 L	1999	-	1998
CHEVROLET	C y K SERIES PICKUP	V-8, 5.7 L	2000	-	1998
CHEVROLET	C-3500	V-8, 5.7 L	2000	-	1996
CADILLAC	ESCALADE	V-8, 5.7 L	2000	-	1999

22359



1 25/32" x 2 5/32 x 3/4" x 21 15/32"

CHEVROLET	EXPRESS	V-8, 6.5 L	2002	-	1999
-----------	---------	------------	------	---	------

22360



1 3/4" x 32 3/16"

CHEVROLET	EXPRESS	V-8, 7.4 L	2000	-	1999
CHEVROLET	EXPRESS	V-8, 6.5 L	2002	-	1999

22361



1 9/32" x 19 3/32"

CHEVROLET	VENTURE	V-6, 3.4 L	2005	-	1997
PONTIAC	AZTEK	V-6, 3.4 L	2005	-	2001

22362



1 9/32" x 31 11/16"

CHEVROLET	EXPRESS	V-6, 4.3 L	2002	-	1999
CHEVROLET	EXPRESS VAN PASAJEROS	V-6, 4.3 L	2000	-	1998

22363



1 15/32" x 16 1/2"

MERCURY	SABLE / TAURUS	V-6, 3.0 L	2001	-	1996
---------	----------------	------------	------	---	------



22364



1 15/32" x 11 11/16"

FORD	RANGER F-100	4 CIL, 2.5 L	2001	-	1998
FORD	RANGER	4 CIL, 2.5 L	2001	-	1999

22368



1 15/32" x 1 15/32" x 23/32" x 10 15/16"

MERCURY	SABLE / TAURUS	V-6, 3.0 L	2000	-	1997
---------	----------------	------------	------	---	------

22365

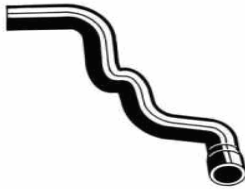

1 17/32" x 1 25/32" x 27 19/32"

CHEVROLET	EXPRESS	V-8, 7.4 L	2000	-	1999
-----------	---------	------------	------	---	------

22369



1 15/32" x 1 15/32" x 23/32" x 9 29/32"

MERCURY	SABLE / TAURUS	V-6, 3.0 L	1996	-	1996
---------	----------------	------------	------	---	------

22366



1 7/32" x 1 5/16" x 19/32" x 19/32" x 19/32" x 11 15/16"

FORD	CONTOUR	4 CIL, 2.0 L	2000	-	1998
MERCURY	MYSTIQUE	4 CIL, 2.0 L	2000	-	1998

22371

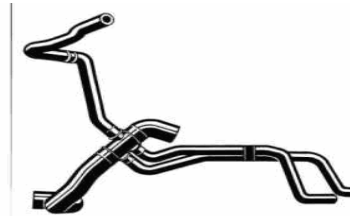

1 23/32" x 1 23/32" x 31/32" x 23/32" x 23/32" x 30"

FORD	SUPER DUTY VAN	V-10, 6.8 L	2001	-	1999
------	----------------	-------------	------	---	------

22367



1 1/4" x 1 11/32" x 19/32" x 19/32" x 19/32" x 11 5/8"

MERCURY	MYSTIQUE	4 CIL, 2.0 L	2000	-	1998
FORD	CONTOUR	4 CIL, 2.0 L	2000	-	1998

22372



1 23/32" x 1 23/32" x 31/32" x 33 7/32"

FORD	E SERIES VAN	V-8, 5.4 L	2007	-	2010
FORD	E SERIES VAN	V-8, 4.6 L	2006	-	2010

22373



1 9/32" x 16 5/16"

## Aplicación por Producto

CHEVROLET	IMPALA	V-6, 3.8 L	2005	-	2000
PONTIAC	GRAND PRIX	V-6, 3.8 L	2005	-	1997

**22374**



1 17/32" x 1 25/32" x 26 19/32"

CHEVROLET	EXPRESS VAN PASAJEROS	V-6, 4.3 L	1999	-	1998
CHEVROLET	EXPRESS	V-6, 4.3 L	1999	-	1999

**22375**



1 9/32" x 17 3/32"

PONTIAC	BONNEVILLE	V-6, 3.8 L	2000	-	1996
OLDSMOBILE	EIGHTY EIGHT	V-6, 3.8 L	1999	-	1998

**22378**



1 11/32" x 1 9/16" x 25 19/32"

CADILLAC	CATERA	V-6, 3.0 L	2001	-	1998
----------	--------	------------	------	---	------

**22379**



1 11/32" x 18 3/32"

CADILLAC	CATERA	V-6, 3.0 L	2001	-	1998
----------	--------	------------	------	---	------

**22380**



1 15/32" x 19 3/32"

FORD	RANGER	4 CIL, 2.5 L	2001	-	1999
FORD	RANGER F-100	4 CIL, 2.5 L	2001	-	1998

**22386**



1 7/32" x 1 15/32" x 5 1/2"

MERCURY	SABLE / TAURUS	V-6, 3.0 L	1999	-	1996
---------	----------------	------------	------	---	------

**22388**



1 7/16" x 1 5/8" x 15/16" x 40"

MERCURY	GRAND MARQUIS	V-8, 4.6 L	2002	-	1998
MERCURY	GRAND MARQUIS	V-8, 4.6 L	2001	-	2000
LINCOLN	TOWN CAR	V-8, 4.6 L	2002	-	1998
FORD	CROWN VICTORIA	V-8, 4.6 L	2002	-	1998

**22392**

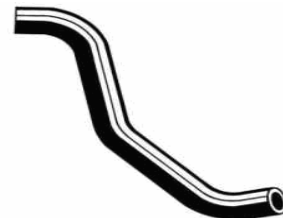

1 15/32" x 22 5/16"

FORD	CROWN VICTORIA	V-8, 4.6 L	2002	-	1998
MERCURY	GRAND MARQUIS	V-8, 4.6 L	2002	-	1998
LINCOLN	TOWN CAR	V-8, 4.6 L	2002	-	2002

**22393**

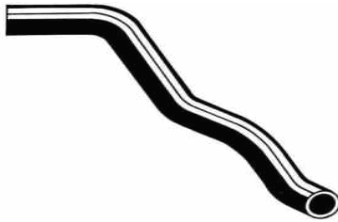

1 15/32" x 21 13/16"

LINCOLN	TOWN CAR	V-8, 4.6 L	1997	-	1995
FORD	CROWN VICTORIA	V-8, 4.6 L	1997	-	1995

**22396**

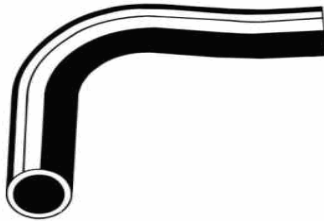

1 11/16" x 17 29/32"

DODGE	RAM WAGON 1500	V-8, 5.2 L	2000	-	1998
DODGE	RAM MAXI VAN 3500	V-8, 5.9 L	2002	-	1998
DODGE	RAM WAGON 2500	V-8, 5.2 L	2000	-	1998
DODGE	RAM MAXI VAN 2500	V-8, 5.2 L	2002	-	1996
DODGE	RAM WAGON 3500	V-8, 5.9 L	2002	-	2002
DODGE	RAM MAXI WAGON 3500	V-8, 5.9 L	2002	-	1998

**22397**



1 11/32" x 17 5/16"

PONTIAC	GRAND AM	4 CIL, 2.4 L	2001	-	1999
---------	----------	--------------	------	---	------

**22398**



19/32" x 23/32" x 3/8" x 15 3/8"

FORD	ESCORT	4 CIL, 2.0 L	2002	-	1999
------	--------	--------------	------	---	------

**22399**



19/32" x 7/8" x 3/8" x 23 1/4"

FORD	ESCORT	4 CIL, 2.0 L	2002	-	1999
------	--------	--------------	------	---	------

**22404**



1 9/32" x 23 11/16"

CHEVROLET	CORVETTE	V-8, 5.7 L	2004	-	1997
-----------	----------	------------	------	---	------

**22405**



1 9/32" x 14 13/32"

CHEVROLET	CORVETTE	V-8, 5.7 L	2004	-	1997
-----------	----------	------------	------	---	------

**22407**



1 1/8" x 1 7/32" x 18 3/16"

VOLKSWAGEN	BEETLE	4 CIL, 2.0 L	2008	-	1998
VOLKSWAGEN	JETTA	4 CIL, 2.0 L	2003	-	2003
VOLKSWAGEN	GOLF	4 CIL, 1.8 L	2003	-	2003
VOLKSWAGEN	GOLF	4 CIL, 2.0 L	2003	-	2003

22408



1 1/8" x 1 7/32" x 34 29/32"

VOLKSWAGEN	BEETLE	4 CIL, 2.0 L	2001	-	1998
------------	--------	--------------	------	---	------

22413



1 7/32" x 16 1/2"

NISSAN	XTERRA	4 CIL, 2.4 L	2001	-	2001
--------	--------	--------------	------	---	------

22416



1 11/32" x 19 13/16"

LAND ROVER	DISCOVERY	V-8, 4.0 L	1999	-	2004
NISSAN	FRONTIER	4 CIL, 2.4 L	2004	-	1999
NISSAN	XTERRA	4 CIL, 2.4 L	2004	-	2000
LAND ROVER	DISCOVERY SERIES II	V-8, 4.0 L	2001	-	1999

22418



1 1/4" x 22"

DODGE	INTREPID	V-6, 2.7 L	2003	-	1998
CHRYSLER	CONCORDE	V-6, 2.7 L	2000	-	1998

22419



1 1/4" x 17 13/32"

DODGE	INTREPID	V-6, 2.7 L	2003	-	1998
CHRYSLER	CONCORDE	V-6, 2.7 L	2000	-	1998

22420



1 1/4" x 16 5/16"

CHRYSLER	CONCORDE	V-6, 3.2 L	2001	-	1998
DODGE	INTREPID	V-6, 3.2 L	2001	-	1999
CHRYSLER	300M	V-6, 3.5 L	2004	-	1999
CHRYSLER	CONCORDE	V-6, 3.5 L	2002	-	2002
DODGE	INTREPID	V-6, 3.5 L	2002	-	2000

22421



1 1/4" x 1 7/16" x 17 13/16"

CHRYSLER	CONCORDE	V-6, 3.5 L	2002	-	2002
CHRYSLER	300M	V-6, 3.5 L	2004	-	1999
DODGE	INTREPID	V-6, 3.2 L	2001	-	1999
CHRYSLER	CONCORDE	V-6, 3.2 L	2001	-	1998
DODGE	INTREPID	V-6, 3.5 L	2002	-	2000

22425



1 17/32" x 1 25/32" x 19 29/32"

CHEVROLET	EXPRESS	V-8, 5.0 L	2002	-	2000
CHEVROLET	EXPRESS	V-8, 5.7 L	2002	-	2000

## Aplicación por Producto

**22426**



1 17/32" x 1 25/32" x 26 11/16"

CHEVROLET	EXPRESS VAN PASAJEROS	V-6, 4.3 L	2000	-	2000
CHEVROLET	EXPRESS	V-6, 4.3 L	2002	-	2000

**22429**



1 23/32" x 20 19/32"

FORD	F-350 SUPER DUTY	V-8, 5.4 L	2006	-	1999
FORD	EXCURSION	V-8, 5.4 L	2002	-	2000
FORD	SUPER DUTY PICKUP	V-8, 5.4 L	2002	-	1999
FORD	F-450 SUPER DUTY	V-8, 5.4 L	2000	-	1999
FORD	F SERIES PICKUP	V-8, 5.4 L	2000	-	1999

**22430**



1 23/32" x 1 23/32" x 3/4" x 3/4" x 39 1/2"

FORD	EXCURSION	V-8, 5.4 L	2002	-	2000
FORD	F-350 SUPER DUTY	V-8, 5.4 L	2006	-	1999
FORD	F-450 SUPER DUTY	V-8, 5.4 L	2000	-	1999
FORD	F SERIES PICKUP	V-8, 5.4 L	2000	-	1999
FORD	EXCURSION	V-10, 6.8 L	2003	-	2002
FORD	SUPER DUTY PICKUP	V-8, 5.4 L	2002	-	1999

**22431**



1 23/32" x 16 29/32"

FORD	EXCURSION	V-10, 6.8 L	2005	-	2000
FORD	F-450 SUPER DUTY	V-10, 6.8 L	2000	-	1999
FORD	F SERIES PICKUP	V-10, 6.8 L	1999	-	1999
FORD	SUPER DUTY PICKUP	V-10, 6.8 L	2002	-	1999

**22432**

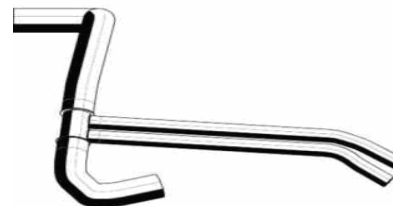

1 23/32" x 1 13/16" x 3/4" x 13/16" x 35 3/16"

FORD	EXCURSION	V-10, 6.8 L	2005	-	2000
FORD	F-450 SUPER DUTY	V-10, 6.8 L	2000	-	2000
FORD	SUPER DUTY PICKUP	V-10, 6.8 L	2002	-	1999

**22433**



1 23/32" x 25"

FORD	SUPER DUTY PICKUP	V-8, 7.3 L	2002	-	1999
FORD	F-450 SUPER DUTY	V-8, 7.3 L	2003	-	1999

**22434**

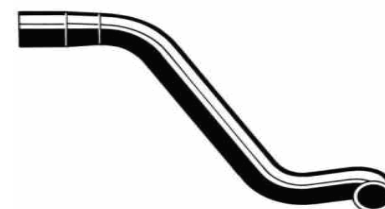

1 3/4" x 2" x 28 3/32"

FORD	F-450 SUPER DUTY	V-8, 7.3 L	2003	-	1999
FORD	SUPER DUTY PICKUP	V-8, 7.3 L	2000	-	1999

**22435**



1 9/32" x 32"

CHEVROLET	SILVERADO	V-6, 4.3 L	2007	-	2010
-----------	-----------	------------	------	---	------



### 22436



1 9/32" x 47 13/16"

CHEVROLET	SILVERADO	V-8, 4.8 L	2007	-	2001
CHEVROLET	SUBURBAN	V-8, 5.3 L	2007	-	2000
CHEVROLET	SONORA	V-8, 5.3 L	2003	-	2003
HUMMER	H2	V-8, 6.0 L	2007	-	2005
CHEVROLET	SILVERADO	V-8, 6.0 L	2007	-	2000
CHEVROLET	SUBURBAN	V-8, 6.0 L	2002	-	2003
CHEVROLET	AVALANCHE	V-8, 5.3 L	2006	-	2002
CHEVROLET	TAHOE	V-8, 5.3 L	2007	-	2006
CADILLAC	ESCALADE	V-8, 6.0 L	2006	-	2002
CADILLAC	ESCALADE	V-8, 5.3 L	2004	-	2002
CHEVROLET	SILVERADO	V-8, 5.3 L	2007	-	2000

### 22437



1 17/32" x 18"

CHEVROLET	TAHOE	V-8, 5.3 L	2007	-	2010
GMC	SIERRA	V-8, 6.2 L	2008	-	2010
CADILLAC	ESCALADE	V-8, 6.2 L	2007	-	2007
CADILLAC	ESCALADE	V-8, 6.0 L	2006	-	2002
CADILLAC	ESCALADE	V-8, 5.3 L	2004	-	2002
GMC	YUKON	V-8, 6.2 L	2008	-	2010
CHEVROLET	AVALANCHE	V-8, 5.3 L	2007	-	2010
CHEVROLET	TAHOE	V-8, 4.8 L	2007	-	2006
CHEVROLET	SUBURBAN	V-8, 6.0 L	2002	-	2003
CADILLAC	ESCALADE	V-8 6.2 L	2007	-	2010
GMC	YUKON	V-8, 5.3 L	2008	-	2007
CHEVROLET	SUBURBAN	V-8, 5.3 L	2007	-	2010
CHEVROLET	SONORA	V-8, 5.3 L	2003	-	2003
CHEVROLET	SILVERADO	V-8, 6.0 L	2007	-	2000
CHEVROLET	SILVERADO	V-8, 4.8 L	2007	-	2010
CHEVROLET	SILVERADO	V-8, 5.3 L	2007	-	2010
GMC	SIERRA	V-8, 5.3 L	2009	-	2010

### 22438



1 17/32" x 1 25/32" x 1" x 24 7/16"

CHEVROLET	SILVERADO	V-6, 4.3 L	2007	-	1999
-----------	-----------	------------	------	---	------

### 22439

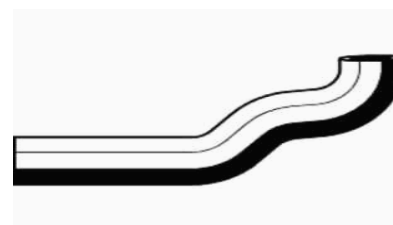

1 5/8" x 13 13/16"

BMW	328IS	V-6, 2.8 L	1999	-	1999
BMW	328I	V-6, 2.8 L	1999	-	1999
BMW	323IS	V-6, 2.5 L	1999	-	1998
BMW	528I	V-6, 2.8 L	1999	-	1998
BMW	323I	V-6, 2.5 L	1999	-	1999
BMW	M	V-6, 3.2 L	1999	-	1999
BMW	Z3	V-6, 2.5 L	2001	-	2000
BMW	Z3	V-6, 2.8 L	2000	-	2000
BMW	Z3	V-6, 3.0 L	2001	-	2001
BMW	M3	V-6, 3.2 L	1999	-	1999

### 22440



1 5/8" x 15 5/16"

BMW	323I	V-6, 2.5 L	1999	-	1999
BMW	323IS	V-6, 2.5 L	1999	-	1998
BMW	328I	V-6, 2.8 L	1999	-	1999
BMW	328IS	V-6, 2.8 L	1999	-	1999
BMW	M3	V-6, 3.2 L	1999	-	1999
BMW	M	V-6, 3.2 L	1999	-	1999
BMW	Z3	V-6, 2.5 L	1999	-	1999

22443



1 11/16" x 22 1/2"

DODGE	RAM 1500	6 CIL, 3.9 L	2003	-	2003
DODGE	RAM MAXI VAN 1500	V-6, 3.9 L	2002	-	2002
DODGE	RAM WAGON 1500	V-6, 3.9 L	2000	-	1998

22448



1 1/2" x 8 13/32"

FORD	WINDSTAR	V-6, 3.8 L	2003	-	1999
FORD	FREESTAR	V-6, 3.9 L	2007	-	2004
FORD	FREESTAR	V-6, 4.2 L	2007	-	2004

22449



1 7/16" x 16 11/16"

FORD	MUSTANG	V-8, 4.6 L	2001	-	1997
------	---------	------------	------	---	------

22451



1 1/2" x 26 3/32"

FORD	EXPLORER	V-6, 4.0 L	2000	-	1999
------	----------	------------	------	---	------

22452

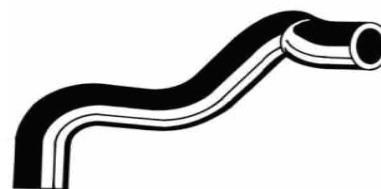

1 1/2" x 1 3/4" x 18 13/16"

FORD	EXPLORER	V-8, 5.0 L	2001	-	1999
------	----------	------------	------	---	------

22453



1 5/16" x 13 3/16"

INFINITI	INFINITI Q45	V-8, 4.1 L	2001	-	1998
----------	--------------	------------	------	---	------

22460

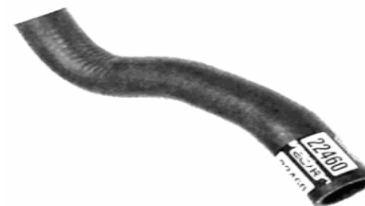

1 1/4" x 1 13/16" x 12 3/32"

DODGE	NEON	4 CIL, 2.0 L	1999	-	1995
-------	------	--------------	------	---	------

22463



1 9/32" x 1 3/8" x 19 5/16"

CHEVROLET	CORVETTE	V-8, 5.7 L	1996	-	1995
-----------	----------	------------	------	---	------

22464

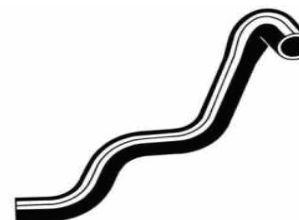

1 9/32" x 1 21/32" x 24 19/32"

CHEVROLET	CORVETTE	V-8, 5.7 L	1996	-	1995
-----------	----------	------------	------	---	------

22465



1 1/4" x 1 19/32" x 3/4" x 18 1/4"

AUDI	A4	4 CIL, 1.8 L	2000	-	2000
------	----	--------------	------	---	------

22467



1 1/2" x 25 3/16"

DODGE	RAM WAGON 1500	V-6, 3.9 L	2000	-	1998
DODGE	RAM 1500	6 CIL, 3.9 L	2003	-	2003
DODGE	RAM MAXI VAN 1500	V-6, 3.9 L	2002	-	2002

22468



19/32" x 19/32" x 1/4" x 34"

FORD	RANGER	V-6, 3.0 L	2001	-	2000
------	--------	------------	------	---	------

22469



19/32" x 19/32" x 1/4" x 34 15/16"

FORD	RANGER	V-6, 3.0 L	2001	-	2001
------	--------	------------	------	---	------

22470

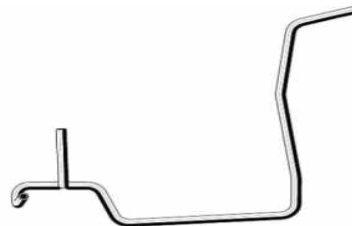

5/8" x 15/16" x 64 11/16"

FORD	E SERIES VAN	V-6, 4.2 L	2000	-	1999
------	--------------	------------	------	---	------

22471



19/32" x 29/32" x 57 5/16"

FORD	E SERIES VAN	V-6, 4.2 L	2000	-	1999
------	--------------	------------	------	---	------

22474



1 1/4" x 13 1/2"

VOLKSWAGEN	GTI	4 CIL, 2.0 L	2000	-	1999
VOLKSWAGEN	JETTA	4 CIL, 2.0 L	2001	-	1994
VOLKSWAGEN	CABRIO	4 CIL, 2.0 L	1995	-	1995
VOLKSWAGEN	GOLF	4 CIL, 2.0 L	2001	-	1997

22477



1 1/2" x 13 11/16"

CADILLAC	DEVILLE	V-8, 4.9 L	1995	-	1994
----------	---------	------------	------	---	------

22478



1 11/32" x 19/16" x 20"

NISSAN	FRONTIER	V-6, 3.3 L	2004	-	1999
NISSAN	XTERRA	V-6, 3.3 L	2002	-	2000

22482

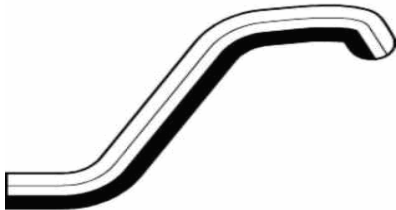

1 1/2" x 23"

DODGE	RAM WAGON 2500	V-8, 5.2 L	2000	-	1998
DODGE	RAM MAXI WAGON 3500	V-8, 5.9 L	2002	-	1998
DODGE	RAM MAXI VAN 3500	V-8, 5.9 L	2002	-	1998
DODGE	RAM MAXI VAN 2500	V-8, 5.2 L	2002	-	2002
DODGE	RAM WAGON 1500	V-8, 5.2 L	2000	-	1998
DODGE	RAM WAGON 3500	V-8, 5.9 L	2002	-	2002

22483

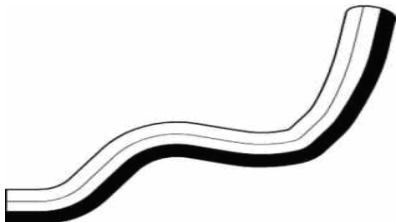

1 1/2" x 1 11/16" x 24 5/16"

JEEP	GRAND CHEROKEE	6 CIL, 4.0 L	2002	-	1999
JEEP	GRAND CHEROKEE	V-6, 4.0 L	2004	-	2003

22484



1 1/2" x 20 13/32"

JEEP	GRAND CHEROKEE	6 CIL, 4.0 L	2002	-	1999
JEEP	GRAND CHEROKEE	V-6, 4.0 L	2004	-	2003

22485



1 1/2" x 1 3/4" x 13 13/16"

JEEP	GRAND CHEROKEE	V-8, 4.7 L	2000	-	1999
------	----------------	------------	------	---	------

22486



1 1/2" x 10 19/32"

JEEP	GRAND CHEROKEE	V-8, 4.7 L	2004	-	1999
------	----------------	------------	------	---	------

22491

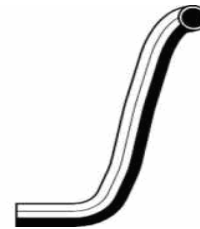

1 15/32" x 1 5/8" x 24 1/2"

TOYOTA	LAND CRUISER	V-8, 4.7 L	2007	-	2003
--------	--------------	------------	------	---	------

22494

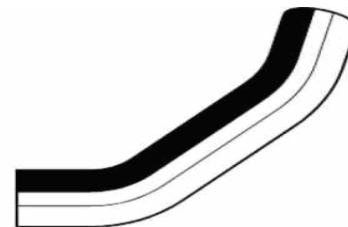

1 1/2" x 10 11/16"

SUBARU	LEGACY	4 CIL, 2.5 L	2007	-	2006
SUBARU	IMPREZA	4 CIL, 2.5 L	2007	-	2006

22498



1 1/2" x 12 5/16"

## Aplicación por Producto

SUBARU FORESTER 4 CIL, 2.5 L 2007 - 2006

**22504**

**22500**



1 1/4" x 1 3/8" x 9 13/16"

FORD FOCUS 4 CIL, 2.0 L 2002 - 2003

**22501**



1 5/16" x 1 7/16" x 13 3/16"

FORD FOCUS 4 CIL, 2.0 L 2002 - 2003

**22502**



1 1/4" x 22 11/16"

FORD FOCUS 4 CIL, 2.0 L 2003 - 2003

**22503**



1 1/4" x 22 1/2"

FORD FOCUS 4 CIL, 2.0 L 2004 - 2003

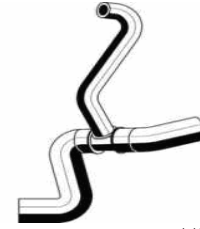

1 1/4" x 1 5/16" x 3/4" x 15 3/32"

FORD FOCUS 4 CIL, 2.0 L 2002 - 2003

**22505**

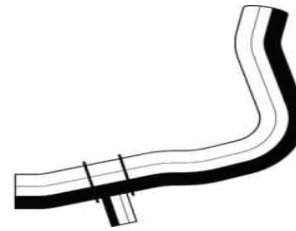

1 1/2" x 1 1/2" x 3/4" x 18 13/16"

MERCURY SABLE / TAURUS V-6, 3.0 L 2005 - 1999

**22508**



1 3/16" x 1 5/16" x 16 3/32"

TOYOTA COROLLA 4 CIL, 1.8 L 2002 - 2002

**22509**



1 7/16" x 15"

BMW 318TI 4 CIL, 1.9 L 1999 - 1998

BMW 318I 4 CIL, 1.9 L 1998 - 1998

JAGUAR S-TYPE V-6, 3.0 L 2005 - 2000

LINCOLN LS V-6, 3.0 L 2001 - 2000



22510



1 7/32" x 1 19/32" x 15"

JAGUAR	S-TYPE	V-6, 3.0 L	2005	-	2003
LINCOLN	LS	V-6, 3.0 L	2001	-	2001

22517



1 3/8" x 10 29/32"

NISSAN	FRONTIER	V-6, 3.3 L	2004	-	1999
NISSAN	XTERRA	V-6, 3.3 L	2002	-	2000

22513

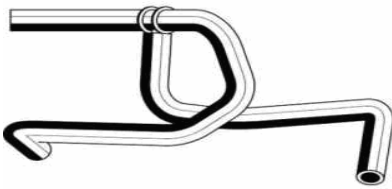

5/8" x 5/8" x 5/8" x 25 1/2"

FORD	EXPEDITION	V-8, 4.6 L	2002	-	1999
FORD	EXPEDITION	V-8, 5.4 L	2002	-	1999
LINCOLN	NAVIGATOR	V-8, 5.4 L	2000	-	1999

22518



1 3/32" x 4 1/2"

NISSAN	XTERRA	V-6, 3.3 L	2002	-	2000
NISSAN	FRONTIER	V-6, 3.3 L	2004	-	1999
NISSAN	PATHFINDER	V-6, 3.3 L	2000	-	1999

22515



1 3/8" x 12 3/16"

NISSAN	ALTIMA	4 CIL, 2.4 L	2001	-	1999
--------	--------	--------------	------	---	------

22519



1" x 5 13/16"

NISSAN	MAXIMA	V-6, 3.0 L	2001	-	2000
INFINITI	INFINITI I30	V-6, 3.0 L	2001	-	2000

22516



1 19/32" x 4 5/16"

NISSAN	FRONTIER	V-6, 3.3 L	2004	-	1999
NISSAN	XTERRA	V-6, 3.3 L	2002	-	2000

22524



1 5/16" x 13 11/16"

CHEVROLET	MALIBU	V-6, 3.1 L	2003	-	1999
PONTIAC	GRAND AM	V-6, 3.4 L	2005	-	1999

## Aplicación por Producto

**22525**



1 1/4" x 44 13/16"

CADILLAC	DEVILLE	V-8, 4.6 L	2005	-	2003
CADILLAC	SEVILLE	V-8, 4.6 L	2004	-	2004

**22526**



1 9/32" x 40 19/32"

CADILLAC	SEVILLE	V-8, 4.6 L	2003	-	2000
----------	---------	------------	------	---	------

**22531**



1 11/32" x 9 3/32"

NISSAN	PATHFINDER	V-6, 3.5 L	2004	-	2001
--------	------------	------------	------	---	------

**22532**



1 11/32" x 24 11/16"

NISSAN	PATHFINDER	V-6, 3.5 L	2004	-	2001
--------	------------	------------	------	---	------

**22534**

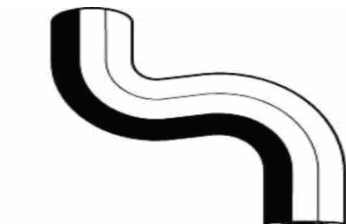

1 5/16" x 9 13/16"

NISSAN	MURANO	6 CIL, 3.5 L	2004	-	2004
NISSAN	SENTRA	4 CIL, 2.0 L	2002	-	2000

**22535**

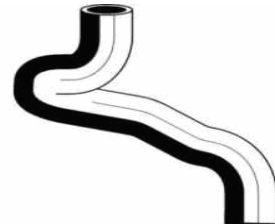

1 5/16" x 20 5/16"

NISSAN	SENTRA	4 CIL, 2.0 L	2002	-	2000
NISSAN	MURANO	6 CIL, 3.5 L	2004	-	2004

**22536**



1 1/32" x 11 11/16"

NISSAN	SENTRA	4 CIL, 1.8 L	2006	-	2000
--------	--------	--------------	------	---	------

**22537**



1 1/32" x 22 5/16"

NISSAN	SENTRA	4 CIL, 1.8 L	2006	-	2000
--------	--------	--------------	------	---	------

**22538**



5/8" x 23/32" x 5/8" x 23 1/8"

FORD	EXPEDITION	V-8, 5.4 L	2002	-	2000
FORD	EXPEDITION	V-8, 4.6 L	2002	-	2000

22539

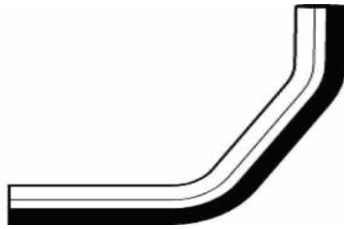

1 3/4" x 20 11/16"

LINCOLN	NAVIGATOR	V-8, 5.4 L	2002	-	1999
---------	-----------	------------	------	---	------

22544



1 15/32" x 18"

DODGE	DURANGO	V-8, 5.9 L	2003	-	2000
-------	---------	------------	------	---	------

22540

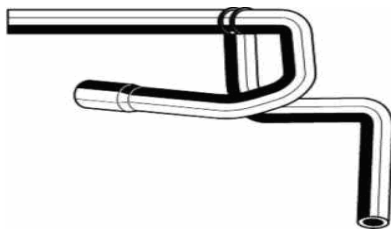

5/8" x 23/32" x 5/8" x 22 3/16"

FORD	EXPEDITION	V-8, 5.4 L	1999	-	1999
FORD	EXPEDITION	V-8, 4.6 L	1999	-	1999
LINCOLN	NAVIGATOR	V-8, 5.4 L	1999	-	1999

22545



1 15/32" x 7 1/2"

DODGE	DURANGO	V-8, 4.7 L	2003	-	2000
-------	---------	------------	------	---	------

22542



1 3/4" x 17"

FORD	SUPER DUTY PICKUP	V-8, 7.3 L	2002	-	1999
------	-------------------	------------	------	---	------

22543



1 15/32" x 13 11/16"

DODGE	DURANGO	V-8, 5.9 L	2003	-	2000
-------	---------	------------	------	---	------

22550



1 23/32" x 16 1/2"

DODGE	DURANGO	V-8, 4.7 L	2003	-	2000
-------	---------	------------	------	---	------

22551



1 23/32" x 19 1/2"

DODGE	DURANGO	V-8, 5.9 L	2003	-	2001
-------	---------	------------	------	---	------

22552



1 11/32" x 15 13/32"

DODGE	NEON	4 CIL, 2.0 L	2002	-	2000
-------	------	--------------	------	---	------

## Aplicación por Producto

CHEVROLET VENTURE V-6, 3.4 L 2005 - 2003

22553



1 1/2" x 10"

SUBARU FORESTER 4 CIL, 2.5 L 2007 - 2006

22554



1" x 3/4" x 5/8" x 5/8" x 19 3/32"

CADILLAC	ESCALADE	V-8, 6.0 L	2004	-	2004
CADILLAC	ESCALADE	V-8, 5.3 L	2004	-	2004
GMC	YUKON	V-8, 5.3 L	2008	-	2007
GMC	YUKON	V-8, 6.2 L	2007	-	2007
CHEVROLET	SUBURBAN	V-8, 6.0 L	2007	-	2003
GMC	SIERRA	V-8, 6.2 L	2007	-	2007
CADILLAC	ESCALADE	V-8 6.2 L	2007	-	2007
CHEVROLET	SUBURBAN	V-8, 5.3 L	2004	-	2003
CHEVROLET	AVALANCHE	V-8, 5.3 L	2004	-	2004

22556



1 5/32" x 14 29/32"

TOYOTA YARIS 4 CIL, 1.5 L 2008 - 2010

22557



1 5/16" x 14"

SUZUKI	AERIO	4 CIL, 2.3 L	2006	-	2005
PONTIAC	AZTEK	V-6, 3.4 L	2005	-	2001

22558



1 1/2" x 1 25/32" x 16 11/16"

CHEVROLET EXPRESS V-8, 8.1 L 2002 - 2001

22559



1 1/2" x 1 25/32" x 26 3/16"

CHEVROLET EXPRESS V-8, 8.1 L 2002 - 2001

22561



1 7/32" x 28 13/32"

FORD MUSTANG V-8, 4.6 L 2001 - 1999

22562

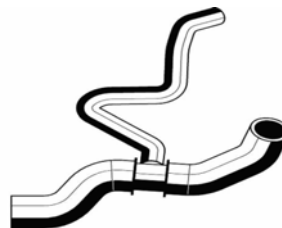

1 7/16" x 1 7/16" x 23 3/32" x 15 1/2"

LINCOLN	LS	V-8, 3.9 L	2002	-	2000
JAGUAR	S-TYPE	V-8, 4.0 L	2005	-	2000

22566



1 7/32" x 34 3/32"

VOLKSWAGEN JETTA 4 CIL, 1.9 L DIESE2005 - 2000

22567

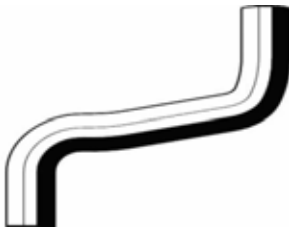

1 7/16" x 20 3/16"

FORD ESCAPE V-6, 3.0 L 2004 - 2001

22568



1 5/16" x 19 29/32"

FORD ESCAPE 4 CIL, 2.0 L 2001 - 2001

22569



1 3/16" x 39 19/32"

FORD ESCAPE V-6, 3.0 L 2004 - 2001

22570



23/32" x 23/32" x 3/8" x 30 7/8"

FORD FOCUS 4 CIL, 2.0 L 2002 - 2000

22571

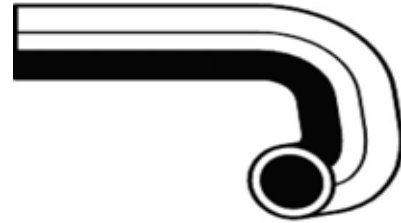

1 7/32" x 9 29/32"

MERCURY SABLE / TAURUS V-6, 3.0 L 2002 - 2002

FORD ESCAPE V-6, 3.0 L 2004 - 2002

22573



1 3/8" x 5 3/32"

MERCEDES BE CLK320 V-6, 3.2 L 2005 - 1999

22574



1 3/8" x 1 5/8" x 12 1/2"

MERCEDES BE CLK320 V-6, 3.2 L 2005 - 1999

MERCEDES BE C280 V-6, 2.8 L 2000 - 1999

22575



1 3/8" x 1 5/8" x 17 13/32"

MERCEDES BE C280 V-6, 2.8 L 2000 - 1999



22576



1 15/32" x 1 5/8" x 20 11/16"

MERCEDES BE E320 V-6, 3.2 L 2006 - 1999

22577



1 1/2" x 1 5/8" x 18 1/2"

MERCEDES BE E320 V-6, 3.2 L 2006 - 2001

22578



1 15/32" x 1 5/8" x 18 29/32"

MERCEDES BE E430 V-8, 4.3 L 2001 - 1999

22579



1 15/32" x 1 5/8" x 15 19/32"

MERCEDES BE E430 V-8, 4.3 L 2000 - 1999

22580



1 3/8" x 1 5/8" x 19 29/32"

MERCEDES BE ML320 V-6, 3.2 L 2001 - 1999

22582



1 13/32" x 1 5/8" x 19 1/2"

MERCEDES BE ML430 V-8, 4.3 L 2001 - 1999

22584

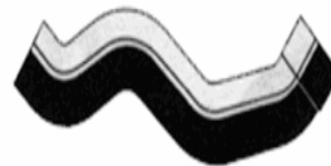

1 13/32" x 1 17/32" x 12 19/32"

MERCEDES BE C230 4 CIL, 2.3 L 2000 - 1999

22585



1 3/8" x 1 5/8" x 12 13/16"

MERCEDES BE C230 4 CIL, 2.3 L 2000 - 1999

22587



1 5/16" x 19 1/2"

MERCEDES BE C280 V-6, 2.8 L 1998 - 1998

22592



1 13/32" x 1 1/2" x 16 3/32"

## Aplicación por Producto

MERCEDES BE SLK230 4 CIL, 2.3 L 2001 - 1999

22602

22593

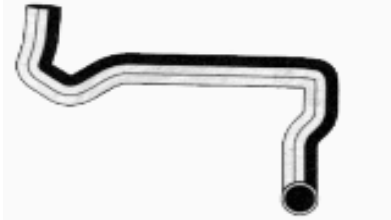

1 3/8" x 1 17/32" x 34 5/16"

MERCEDES BE SLK230 4 CIL, 2.3 L 1999 - 1999

22594



1 13/32" x 1 15/32" x 27 13/32"

MERCEDES BE SLK230 4 CIL, 2.3 L 2001 - 2000

22595



1 15/32" x 1 5/8" x 31 29/32"

MERCEDES BE S500 V-8, 5.0 L 1999 - 1999

MERCEDES BE S420 V-8, 4.2 L 1999 - 1998

MERCEDES BE CL500 V-8, 5.0 L 1999 - 1999

22598



1 7/32" x 1 15/32" x 1/4" x 14 19/32"

VOLKSWAGEN JETTA V-6, 2.8 L 1999 - 1999

VOLKSWAGEN GTI V-6, 2.8 L 1999 - 1999



1 1/4" x 18 5/8"

VOLKSWAGEN GTI V-6, 2.8 L 1999 - 1999

22603

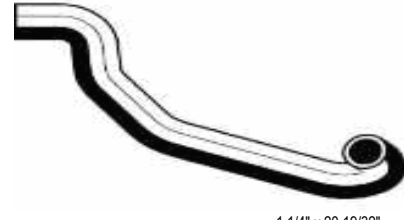

1 1/4" x 20 19/32"

VOLKSWAGEN GTI V-6, 2.8 L 1999 - 1999

VOLKSWAGEN JETTA V-6, 2.8 L 1999 - 1999

VOLKSWAGEN PASSAT V-6, 2.8 L 1999 - 1999

22611



1 5/16" x 1 7/16" x 25"

LAND ROVER DISCOVERY V-8, 4.0 L 1999 - 1999

22615



1 1/4" x 31 11/16"

VOLKSWAGEN GOLF 4 CIL, 1.8 L 2003 - 2003

VOLKSWAGEN BEETLE 4 CIL, 2.0 L 2008 - 2002

VOLKSWAGEN BEETLE 4 CIL, 1.8 L 2005 - 1999

VOLKSWAGEN JETTA 4 CIL, 2.0 L 2003 - 2003

VOLKSWAGEN JETTA 4 CIL, 1.8 L 2003 - 2003

VOLKSWAGEN GOLF 4 CIL, 2.0 L 2003 - 2003

## Aplicación por Producto

**22625**



1 11/32" x 1 1/2" x 20 13/32"

CHRYSLER	VOYAGER	V-6, 3.8 L	2006	-	2004
CHRYSLER	VOYAGER	V-6, 3.3 L	2007	-	2002
DODGE	CARAVAN	V-6, 3.3 L FLEX	2003	-	2001
DODGE	CARAVAN	V-6, 3.3 L	2007	-	2004
CHRYSLER	TOWN & COUNTRY	V-6, 3.8 L	2007	-	2001

**22626**



1 11/32" x 1 1/2" x 12 11/16"

DODGE	CARAVAN	V-6, 3.3 L	2007	-	2004
CHRYSLER	VOYAGER	V-6, 3.8 L	2006	-	2004
CHRYSLER	VOYAGER	V-6, 3.3 L	2007	-	2002
DODGE	CARAVAN	V-6, 3.3 L FLEX	2003	-	2001
CHRYSLER	TOWN & COUNTRY	V-6, 3.8 L	2007	-	2001

**22627**



1 5/16" x 15 29/32"

CHRYSLER	PT CRUISER	4 CIL, 2.4 L	2007	-	2010
----------	------------	--------------	------	---	------

**22628**



CORTAR A MEDIDA

1 5/16" x 30 13/32"

CHRYSLER	SEBRING	V-6, 3.0 L	2005	-	2005
DODGE	STRATUS	V-6, 3.0 L	2002	-	2001
MITSUBISHI	ECLIPSE	V-6, 3.0 L	2005	-	2004

CHRYSLER	SEBRING	V-6, 3.0 L	2006	-	2006
DODGE	STRATUS	4 CIL, 2.4 L	2003	-	2001

**22629**



1 1/4" x 1 9/32" x 17 5/16"

DODGE	STRATUS	4 CIL, 2.4 L	2006	-	2004
-------	---------	--------------	------	---	------

**22630**



1 7/32" x 21 13/16"

DODGE	STRATUS	V-6, 2.7 L	2002	-	2002
-------	---------	------------	------	---	------

**22631**

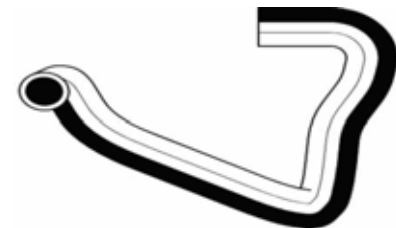

1 1/4" x 28 13/32"

DODGE	STRATUS	V-6, 2.7 L	2002	-	2001
-------	---------	------------	------	---	------

**22635**



1 3/8" x 1 7/16" x 17 29/32"

BMW	318I	4 CIL, 1.9 L	1998	-	1998
BMW	318TI	4 CIL, 1.9 L	1999	-	1998

22637



1 17/32" x 18 11/16"

BMW	750iL	V-12, 5.4 L	2001	-	1998
BMW	528i	V-6, 2.8 L	1999	-	1998

22638



1 1/2" x 10 1/8"

BMW	530i	6 CIL, 3.0 L	2002	-	2002
BMW	528i	V-6, 2.8 L	2000	-	2000
BMW	323Ci	V-6, 2.5 L	2000	-	2000
BMW	525i	6 CIL, 2.5 L	2005	-	2001
BMW	323i	V-6, 2.5 L	2000	-	2000
BMW	328i	V-6, 2.8 L	2000	-	2000

22639



1 1/2" x 14 3/32"

BMW	330Ci	V-6, 3.0 L	2006	-	2004
BMW	530i	6 CIL, 3.0 L	2002	-	2002
BMW	525i	6 CIL, 2.5 L	2005	-	2001
BMW	Z3	V-6, 2.8 L	2000	-	2000
BMW	323i	V-6, 2.5 L	2000	-	2000
BMW	Z3	V-6, 2.5 L	2001	-	1999
BMW	323Ci	V-6, 2.5 L	2000	-	2000
BMW	Z3	V-6, 3.0 L	2001	-	2001
BMW	528i	V-6, 2.8 L	2000	-	2000
BMW	330Ci	6 CIL, 3.0 L	2003	-	2001
BMW	328i	V-6, 2.8 L	2000	-	2000
BMW	325i	V-6, 2.5 L	2003	-	2001

22646



1 15/32" x 35 19/32"

FORD	RANGER	V-6, 4.0 L	2001	-	2001
FORD	EXPLORER SPORT TRAC	V-6, 4.0 L	2006	-	2004

22648



1 5/16" x 1 17/32" x 14 19/32"

CHEVROLET	C y K SERIES PICKUP	V-8, 8.1 L	2002	-	2001
-----------	---------------------	------------	------	---	------

22651

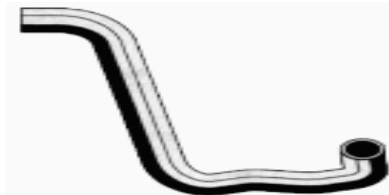

1 5/16" x 1 17/32" x 30"

CHEVROLET	TRAILBLAZER	6 CIL, 4.2 L	2007	-	2002
-----------	-------------	--------------	------	---	------

22652



1 5/16" x 10 3/32"

CHEVROLET	TRAILBLAZER	6 CIL, 4.2 L	2007	-	2002
-----------	-------------	--------------	------	---	------

22653



1 1/4" x 1 15/32" x 17 11/32"

## Aplicación por Producto

FORD RANGER 4 CIL, 2.3 L 2004 - 2001

**22661**

**22654**



1 1/4" x 1 15/32" x 22 13/32"

FORD RANGER 4 CIL, 2.3 L 2007 - 2009

**22656**



1 11/32" x 17 19/32"

MITSUBISHI MONTERO V-6, 3.8 L 2007 - 2004

**22657**



1 5/16" x 35"

MITSUBISHI MONTERO V-6, 3.8 L 2007 - 2004

**22658**

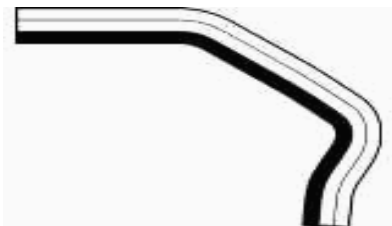

1 11/32" x 21"

MITSUBISHI MONTERO SPORT V-6, 3.5 L 2004 - 2004

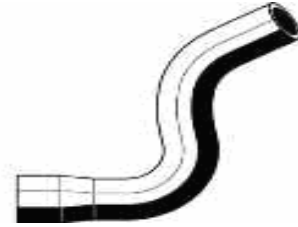

1 15/32" x 1 25/32" x 15 5/16"

JEEP GRAND CHEROKEE V-8, 4.7 L 2004 - 2001

**22667**



1 3/16" x 1 1/4" x 22 5/8"

FORD TOPAZ 4 CIL, 2.3 L 1994 - 1994

**22676**



1 1/4" x 1 13/32" x 14 9/16"

VOLVO S80 6 CIL, 2.9 L 2005 - 1999

VOLVO S80 6 CIL, 2.8 L 2001 - 1999

**22677**



1 7/32" x 1 13/32" x 31 13/32"

VOLVO S80 6 CIL, 2.8 L 2001 - 1999

VOLVO S80 6 CIL, 2.9 L 2005 - 1999



22681



1 13/32" x 24 5/16"

FORD	AEROSTAR	V-6, 4.0 L	1995	-	1995
------	----------	------------	------	---	------

22691



1 7/16" x 19 7/32"

FORD	EXPLORER	V-6, 4.0 L	2007	-	2004
------	----------	------------	------	---	------

22682



1 1/2" x 14 29/32"

CHEVROLET	SUBURBAN	V-8, 8.1 L	2006	-	2003
-----------	----------	------------	------	---	------

22692



1 15/32" x 17 32/32"

DODGE	RAM 2500	V-8, 4.7 L	2003	-	2008
DODGE	STRATUS	4 CIL, 2.4 L	2002	-	2002

22688



1 5/16" x 12 19/32"

TOYOTA	RAV 4	4 CIL, 2.4 L	2006	-	2003
CHEVROLET	MALIBU	V-6, 3.5 L	2006	-	2004
CHEVROLET	MALIBU	V-6, 3.5 L	2005	-	2005
TOYOTA	RAV 4	4 CIL, 2.0 L	2003	-	2003
PONTIAC	G6	V-6, 3.5 L	2006	-	2006

22693



1 23/32" x 19 21/32"

DODGE	RAM 2500	V-8, 4.7 L	2003	-	2008
-------	----------	------------	------	---	------

22696



1 9/32" x 19 3/16"

PONTIAC	GRAND AM	4 CIL, 2.2 L	2002	-	2002
CHEVROLET	MALIBU	4 CIL, 2.2 L	2004	-	2004

22689



1 5/16" x 12 17/32"

TOYOTA	RAV 4	4 CIL, 2.4 L	2006	-	2003
--------	-------	--------------	------	---	------

**22697**



1 5/16" x 1 5/16" x 3/4" x 18 13/32"

PONTIAC	GRAND AM	4 CIL, 2.2 L	2002	-	2002
CHEVROLET	MALIBU	4 CIL, 2.2 L	2004	-	2004

**22698**



1 13/16" x 21 19/32"

TOYOTA	RAV 4	4 CIL, 2.0 L	2003	-	2003
CHEVROLET	SILVERADO	V-8, 6.6 L	2007	-	2001

**22708**



1 5/16" x 1 5/16" x 3/4" x 20 19/32"

CHEVROLET	CAVALIER	4 CIL, 2.2 L	2005	-	2002
PONTIAC	SUNFIRE	4 CIL, 2.2 L	2005	-	2003

**22718**



1 25/32" x 12 1/32"

JEEP	LIBERTY	V-6, 3.7 L	2007	-	2002
------	---------	------------	------	---	------

**22719**



1 15/32" x 10 27/32"

JEEP	LIBERTY	V-6, 3.7 L	2007	-	2002
------	---------	------------	------	---	------

**22720**



1 5/16" x 16 9/32"

MINIBISHI	LANCER	4 CIL, 2.0 L	2006	-	2008
-----------	--------	--------------	------	---	------

**22722**



1 9/32" x 1 1/2" x 21 3/16"

CADILLAC	CTS	V-6, 3.2 L	2004	-	2004
----------	-----	------------	------	---	------

**22723**



1 9/32" x 20 13/32"

CADILLAC	CTS	V-6, 3.2 L	2004	-	2004
----------	-----	------------	------	---	------

**22730**



1 5/16" x 15 11/16"

SUZUKI	AERIO	4 CIL, 2.3 L	2006	-	2005
--------	-------	--------------	------	---	------

**22746**



1 11/16" x 21 13/32"

DODGE	RAM 1500	V-6, 3.7 L	2005	-	2004
-------	----------	------------	------	---	------

**22750**



1 1/2" x 15 19/32"

HUMMER	H2	V-8, 6.0 L	2007	-	2005
--------	----	------------	------	---	------

**22751**



1 9/32" x 37 19/32"

CHEVROLET	EXPRESS CARGO VAN	V-6, 4.3 L	2007	-	2010
CHEVROLET	EXPRESS	V-6, 4.3 L	2003	-	2003

**22752**



1 1/2" x 1 3/4" x 30 13/32"

CHEVROLET	EXPRESS	V-6, 4.3 L	2003	-	2003
-----------	---------	------------	------	---	------

**22753**



1 9/32" x 16 29/32"

CHEVROLET	TRAILBLAZER	V-8, 5.3 L	2007	-	2003
-----------	-------------	------------	------	---	------

**22754**



1 9/16" x 22 3/32"

CHEVROLET	TRAILBLAZER	V-8, 5.3 L	2007	-	2003
-----------	-------------	------------	------	---	------

**22755**



1 9/32" x 41 29/32"

CHEVROLET	EXPRESS	V-8, 6.0 L	2007	-	2004
CHEVROLET	EXPRESS	V-8, 5.3 L	2007	-	2004

**22756**



1 17/32" x 19 1/2"

CHEVROLET	EXPRESS	V-8, 5.3 L	2007	-	2003
CHEVROLET	EXPRESS	V-8, 6.0 L	2007	-	2003

22757



1 3/16" x 1 11/32" x 20 29/32"

TOYOTA	MATRIX	4 CIL, 1.8 L	2008	-	2003
TOYOTA	COROLLA	4 CIL, 1.8 L	2008	-	2003

22777



1 15/32" x 1 3/4" x 21 1/8"

DODGE	RAM 2500	V-8, 5.7 L	2008	-	2008
DODGE	RAM 3500	V-8, 5.7 L	2007	-	2003

22758



1 5/16" x 19 29/32"

TOYOTA	MATRIX	4 CIL, 1.8 L	2008	-	2003
TOYOTA	COROLLA	4 CIL, 1.8 L	2008	-	2003

22788



1 1/2" x 21 3/8"

FORD	MONDEO	V-6, 2.5 L	2003	-	2003
MERCURY	GRAND MARQUIS	V-8, 4.6 L	2005	-	2003
FORD	MONDEO	4 CIL, 2.0 L	2003	-	2003

22759



1 5/16" x 20 19/32"

TOYOTA	MATRIX	4 CIL, 1.8 L	2006	-	2003
--------	--------	--------------	------	---	------

22789



1 7/16" x 25 3/4"

FORD	EXPLORER	V-6, 4.0 L	1995	-	1995
------	----------	------------	------	---	------

22761



1 1/2" x 20 13/32"

DODGE	RAM 1500	V-6, 3.7 L	2005	-	2008
-------	----------	------------	------	---	------

22790



1 7/16" x 16 1/2"

FORD	EXPLORER	V-8, 4.6 L	2007	-	2004
------	----------	------------	------	---	------

## Aplicación por Producto

22791



1 1/2" X 25 17/32"

FORD EXPLORER V-8, 4.6 L 2007 - 2004

22793



1 1/2" x 15 19/32"

FORD EXPLORER V-6, 4.0 L 2007 - 2004

22805



1 3/16" x 36 5/8"

FORD ESCAPE V-6, 3.0 L 2005 - 2006

22807



1 1/2" x 29 29/32"

FORD MUSTANG V-8, 4.6 L 2004 - 2004

22808



1 7/32" x 32 13/16"

VOLKSWAGEN GOLF 4 CIL, 2.0 L 2006 - 2000

VOLKSWAGEN	GOLF	4 CIL, 1.8 L	2006	-	2001
VOLKSWAGEN	JETTA	4 CIL, 1.8 L	2006	-	2001
VOLKSWAGEN	JETTA	4 CIL, 2.0 L	2008	-	2010

22809



1 1/2" x 22"

LINCOLN TOWN CAR V-8, 4.6 L 2002 - 1998

22811



1 1/2" x 9 5/16"

MERCURY SABLE / TAURUS V-6, 3.0 L 2005 - 2000

22813



1 1/4" x 16"

CHEVROLET IMPALA V-6, 3.4 L 2005 - 2004

22814



1 9/32" x 18 29/32"

CHEVROLET	IMPALA	V-6, 3.4 L	2005	-	2004
PONTIAC	GRAND PRIX	V-6, 3.8 L	2005	-	2004
CHRYSLER	PT CRUISER	4 CIL, 2.4 L	2005	-	2005
CHEVROLET	IMPALA	V-6, 3.8 L	2005	-	2004



22817



VOLVO	S60	5 CIL, 2.5 L	2006	-	2004
-------	-----	--------------	------	---	------

22825



1 5/16" x 21 3/32"

TOYOTA	SOLARA	V-6, 3.3 L	2006	-	2005
TOYOTA	CAMRY	V-6, 3.0 L	2006	-	2003

22819



VOLVO	S60	5 CIL, 2.5 L	2006	-	2004
VOLVO	S60	5 CIL, 2.3 L	2001	-	2001
VOLVO	S60	5 CIL, 2.4 L	2001	-	2001

22826



1 9/32" x 16 11/16"

TOYOTA	CAMRY	4 CIL, 2.4 L	2006	-	2003
--------	-------	--------------	------	---	------

22821



1 11/32" x 25 1/2"

NISSAN	MAXIMA	V-6, 3.0 L	1994	-	1993
--------	--------	------------	------	---	------

22827



1 9/32" x 14 19/32"

TOYOTA	CAMRY	4 CIL, 2.4 L	2006	-	2003
HYUNDAI	ATTITUDE	4 CIL, 1.6 L	2006	-	2007
HYUNDAI	ATTITUDE	4 CIL, 1.6 L	2008	-	2010
HYUNDAI	ATTITUDE	4 CIL, 1.4 L	2008	-	2010

22822



1 9/32" x 15 13/32"

PONTIAC	G6	V-6, 3.5 L	2006	-	2006
CHEVROLET	MALIBU	V-6, 3.5 L	2006	-	2005

22829



HONDA	CIVIC	4 CIL, 1.7 L	2005	-	2003
-------	-------	--------------	------	---	------

22830



HONDA CIVIC 4 CIL, 1.7 L 2005 - 2003

22831



1 15/32" x 20 3/32"

TOYOTA 4 RUNNER V-8, 4.7 L 2007 - 2004

22832



1 15/32" x 20 3/16"

TOYOTA 4 RUNNER V-8, 4.7 L 2007 - 2004

22834



MAZDA MAZDA 6 4 CIL, 2.3 L 2007 - 2008

22835



MAZDA MAZDA 6 V-6, 3.0 L 2007 - 2006

22836



MAZDA MAZDA 6 V-6, 3.0 L 2007 - 2006

22837



MAZDA MAZDA 6 4 CIL, 2.3 L 2007 - 2008

22838



MAZDA MAZDA 6 V-6, 3.0 L 2007 - 2006

22839



JAGUAR S-TYPE V-6, 3.0 L 2005 - 2003

22844



15/16" x 17 3/16"

## Aplicación por Producto

TOYOTA	FJ CRUISER	V-6, 4.0 L	2008	-	2007
TOYOTA	TACOMA	V-6, 4.0 L	2008	-	2010

**22845**



1 5/16" x 19 11/16"

TOYOTA	FJ CRUISER	V-6, 4.0 L	2008	-	2007
TOYOTA	TACOMA	V-6, 4.0 L	2008	-	2010

**22848**



HONDA	CR-V	4 CIL, 2.0 L	2002	-	2002
HONDA	CR-V	4 CIL, 2.4 L	2006	-	2006

**22849**



HONDA	CR-V	4 CIL, 2.4 L	2006	-	2006
-------	------	--------------	------	---	------

**22851**



1 5/16" x 1 1/2" x 17 3/16"

CHRYSLER	PACIFICA	V-6, 3.5 L	2006	-	2005
CHRYSLER	PACIFICA	V-6, 3.8 L	2006	-	2005

**22852**

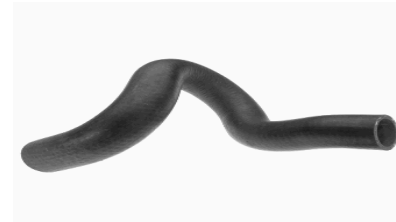

1 5/16" x 1 1/2" x 19 5/16"

CHRYSLER	PACIFICA	V-6, 3.5 L	2006	-	2005
CHRYSLER	PACIFICA	V-6, 3.8 L	2006	-	2005

**22853**



1 1/4" x 19 11/16"

CHRYSLER	PT CRUISER	4 CIL, 2.4 L	2007	-	2010
----------	------------	--------------	------	---	------

**22858**



FORD	EXPEDITION	V-8, 5.4 L	2005	-	2006
------	------------	------------	------	---	------

**22859**



FORD	F-250	V-8, 4.6 L	2006	-	2005
FORD	LOBO	V-8, 5.4 L	2007	-	2008
FORD	LOBO	V-8, 4.6 L	2006	-	2008
FORD	F-150	V-8, 4.6 L	2008	-	2008

**22863**



FORD	LOBO	V-8, 4.6 L	2006	-	2008
FORD	LOBO	V-8, 5.4 L	2007	-	2008
FORD	F-150	V-8, 4.6 L	2008	-	2008
FORD	F-250	V-8, 4.6 L	2006	-	2005

**22870**



MITSUBISHI	ENDEAVOR	V-6, 3.8 L	2004	-	2004
MITSUBISHI	ENDEAVOR	V-6, 3.8 L	2007	-	2005

**22871**



MITSUBISHI	ENDEAVOR	V-6, 3.8 L	2007	-	2005
MITSUBISHI	ENDEAVOR	V-6, 3.8 L	2004	-	2004
MITSUBISHI	OUTLANDER	4 CIL, 2.4 L	2006	-	2004

**22875**



VOLKSWAGEN	GOLF	4 CIL, 2.0 L	2005	-	2002
VOLKSWAGEN	GOLF	4 CIL, 2.0 L	2006	-	2006
VOLKSWAGEN	JETTA	4 CIL, 2.0 L	2008	-	2010
VOLKSWAGEN	JETTA	4 CIL, 2.0 L	2006	-	2006
VOLKSWAGEN	JETTA	4 CIL, 2.0 L	2005	-	2005

**22876**



VOLKSWAGEN	JETTA	4 CIL, 2.0 L	2008	-	2010
VOLKSWAGEN	GOLF	4 CIL, 2.0 L	2006	-	2006
VOLKSWAGEN	JETTA	4 CIL, 2.0 L	2006	-	2005
VOLKSWAGEN	GOLF	4 CIL, 2.0 L	2005	-	2002

**22879**



VOLKSWAGEN	GOLF	4 CIL, 1.8 L	2006	-	2001
VOLKSWAGEN	JETTA	4 CIL, 1.8 L	2006	-	2001

**22880**

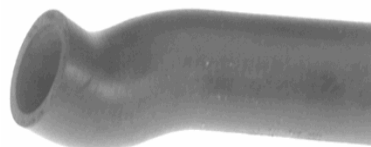

VOLKSWAGEN	GOLF	4 CIL, 1.8 L	2004	-	2001
VOLKSWAGEN	JETTA	4 CIL, 1.9 L DIESE	2005	-	2002
VOLKSWAGEN	JETTA	4 CIL, 1.8 L	2004	-	2001

**22883**



DODGE	NEON	4 CIL, 2.4 L	2006	-	2004
-------	------	--------------	------	---	------

22884



VOLKSWAGEN	JETTA	4 CIL, 1.9 L DIESEL	2005	-	2002
DODGE	NEON	4 CIL, 2.4 L	2006	-	2004
DODGE	NEON	4 CIL, 2.0 L	2006	-	2004

22888



mitsubishi	LANCER	4 CIL, 2.0 L	2006	-	2004
------------	--------	--------------	------	---	------

22892



DODGE	RAM 4000	V-6, 6.7 L DIESEL	2008	-	2008
DODGE	RAM 4000	V-6, 5.9 L DIESEL	2007	-	2003

22893



DODGE	RAM 4000	V-6, 5.9 L DIESEL	2007	-	2003
DODGE	RAM 4000	V-6, 6.7 L DIESEL	2008	-	2008

22894

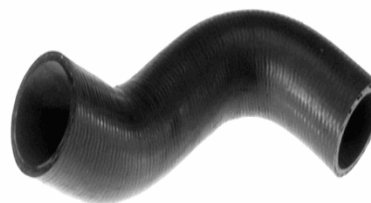

DODGE	DURANGO	V-8, 4.7 L	2005	-	2005
-------	---------	------------	------	---	------

22885



SUBARU	OUTBACK	4 CIL, 2.5 L	2007	-	2006
SUBARU	IMPREZA	4 CIL, 2.5 L	2007	-	2006

22886



SUBARU	OUTBACK	4 CIL, 2.5 L	2007	-	2006
SUBARU	IMPREZA	4 CIL, 2.5 L	2007	-	2006
SUBARU	LEGACY	4 CIL, 2.5 L	2007	-	2006

22887



mitsubishi	LANCER	4 CIL, 2.0 L	2006	-	2004
------------	--------	--------------	------	---	------



**22896**



DODGE	DURANGO	V-8, 5.7 L	2007	-	2005
CHRYSLER	ASPEN	V-8, 5.7 L	2007	-	2009

**22907**



CHEVROLET	COLORADO	4 CIL, 2.8 L	2006	-	2005
CHEVROLET	COLORADO	4 CIL, 2.9 L	2007	-	2010

**22897**



CHRYSLER	ASPEN	V-8, 5.7 L	2007	-	2009
DODGE	DURANGO	V-8, 5.7 L	2007	-	2005

**22908**



CHEVROLET	COLORADO	4 CIL, 2.8 L	2006	-	2006
CHEVROLET	COLORADO	4 CIL, 2.9 L	2007	-	2010

**22901**



TOYOTA	SIENNA	V-6, 3.3 L	2006	-	2004
--------	--------	------------	------	---	------

**22911**



CADILLAC	CTS	V-6, 3.6 L	2006	-	2005
----------	-----	------------	------	---	------

**22902**



TOYOTA	SIENNA	V-6, 3.3 L	2006	-	2004
--------	--------	------------	------	---	------

**22912**



CADILLAC	CTS	V-6, 3.6 L	2006	-	2005
----------	-----	------------	------	---	------

22913



CHEVROLET	OPTRA	4 CIL, 2.0 L	2008	-	2006
CHEVROLET	OPTRA	4 CIL, 2.0 L	2009	-	2010

22914



CHEVROLET	OPTRA	4 CIL, 2.0 L	2009	-	2010
CHEVROLET	OPTRA	4 CIL, 2.0 L	2008	-	2006

22917



HUMMER	H3	5 CIL, 3.7 L	2008	-	2010
GMC	CANYON	5 CIL, 3.7 L	2008	-	2010
CHEVROLET	COLORADO	5 CIL, 3.7 L	2007	-	2010
CHEVROLET	COLORADO	5 CIL, 3.5 L	2006	-	2006
HUMMER	H3	5 CIL, 3.5 L	2007	-	2006

22918



PONTIAC	G3	4 CIL, 1.6 L	2008	-	2006
CHEVROLET	AVEO	4 CIL, 1.6 L	2009	-	2009
CHEVROLET	AVEO	4 CIL, 1.6 L	2008	-	2008
SUZUKI	SWIFT	4 CIL, 1.6 L	2007	-	2008

22927



CHEVROLET	SUBURBAN	V-8, 8.1 L	2006	-	2003
-----------	----------	------------	------	---	------

22931



SAAB	9-3	4 CIL, 2.3 L	2002	-	2000
SAAB	9-3	4 CIL, 2.0 L	2003	-	1999

22932



SAAB	9-5	V-6, 3.0 L	2003	-	2003
SAAB	9-5	4 CIL, 2.3 L	2007	-	2002

22934



SAAB	9-5	V-6, 3.0 L	2002	-	2002
------	-----	------------	------	---	------

**22936**



SAAB	9 - 5	V-6, 3.0 L	2003	-	2003
SAAB	9 - 5	4 CIL, 2.3 L	2007	-	2002

**22942**



DODGE	CHARGER	V-6, 3.5 L	2008	-	2009
CHRYSLER	300 C	V-6, 3.5 L	2006	-	2009

**22937**



SAAB	9 - 3	4 CIL, 2.0 L	2007	-	2003
------	-------	--------------	------	---	------

**22943**



DODGE	CHARGER	V-6, 3.5 L	2008	-	2007
CHRYSLER	300 C	V-6, 3.5 L	2006	-	2005

**22940**



CHRYSLER	300 C	V-8, 6.1 L	2006	-	2005
DODGE	CHARGER	V-8, 5.7 L	2008	-	2007
CHRYSLER	300 C	V-8, 5.7 L	2006	-	2009

**22963**



NISSAN	ALTIMA	V-6, 3.5 L	2006	-	2002
NISSAN	MAXIMA	V-6, 3.5 L	2007	-	2008

**22941**



DODGE	CHARGER	V-8, 5.7 L	2008	-	2007
CHRYSLER	300 C	V-8, 5.7 L	2006	-	2009
CHRYSLER	300 C	V-8, 6.1 L	2006	-	2005

**22964**



NISSAN	ALTIMA	V-6, 3.5 L	2006	-	2002
NISSAN	QUEST	V-6, 3.5 L	2007	-	2009
NISSAN	MAXIMA	V-6, 3.5 L	2007	-	2008

22965



NISSAN ..... ALTIMA ..... 4 CIL, 2.5 L ..... 2006 - 2003

22966



NISSAN ..... ALTIMA ..... 4 CIL, 2.5 L ..... 2006 - 2003

22967



NISSAN ..... 350Z ..... V-6, 3.5 L ..... 2006 - 2003

22968



NISSAN ..... 350Z ..... V-6, 3.5 L ..... 2006 - 2003

22969



NISSAN ..... MAXIMA ..... V-6, 3.5 L ..... 2004 - 2004

22970



NISSAN ..... MAXIMA ..... V-6, 3.5 L ..... 2004 - 2003

22971



NISSAN ..... SENTRA ..... 4 CIL, 2.5 L ..... 2006 - 2010

22972



NISSAN ..... SENTRA ..... 4 CIL, 2.5 L ..... 2006 - 2010

22983



NISSAN ..... GALANT ..... V-6, 3.8 L ..... 2007 - 2005

22984



## Aplicación por Producto

MITSUBISHI GALANT V-6, 3.8 L 2007 - 2005

**22989**



**22985**



MITSUBISHI LANCER 4 CIL, 2.0 L 2007 - 2008

**22994**



MITSUBISHI LANCER 4 CIL, 2.4 L 2006 - 2004

**22986**



MERCURY GRAND MARQUIS V-8, 4.6 L 2003 - 2003

LINCOLN TOWN CAR V-8, 4.6 L 2003 - 2003

MITSUBISHI LANCER 4 CIL, 2.4 L 2006 - 2004

**22987**



**22997**



MITSUBISHI LANCER 4 CIL, 2.4 L 2006 - 2004

DODGE NEON 4 CIL, 2.0 L 2006 - 2004

**22988**



**23019**



MITSUBISHI LANCER 4 CIL, 2.0 L 2006 - 2008

CHEVROLET EQUINOX V-6, 3.4 L 2007 - 2006

**23020**





## Aplicación por Producto

CHEVROLET	EQUINOX	V-6, 3.4 L	2007	-	2006
PONTIAC	TORRENT	V-6, 3.4 L	2008	-	2006

**23036**



**23021**



JEEP	GRAND CHEROKEE	V-8, 5.7 L	2007	-	2009
JEEP	COMMANDER	V-8, 5.7 L	2008	-	2009
JEEP	GRAND CHEROKEE	V-8, 6.1 L	2007	-	2009

**23037**



CHEVROLET	MALIBU	4 CIL, 2.4 L	2008	-	2010
CHEVROLET	MALIBU	4 CIL, 2.2 L	2007	-	2006

**23022**



JEEP	GRAND CHEROKEE	V-8, 4.7 L	2007	-	2005
------	----------------	------------	------	---	------

CHEVROLET	MALIBU	4 CIL, 2.2 L	2006	-	2006
-----------	--------	--------------	------	---	------

**23028**



**23038**



CADILLAC	CTS	V-6, 3.6 L	2007	-	2007
----------	-----	------------	------	---	------

JEEP	GRAND CHEROKEE	V-8, 4.7 L	2007	-	2005
------	----------------	------------	------	---	------

**23035**



**23039**



JEEP	GRAND CHEROKEE	V-8, 5.7 L	2007	-	2009
JEEP	COMMANDER	V-8, 5.7 L	2008	-	2009

JEEP	GRAND CHEROKEE	V-6, 3.7 L	2007	-	2009
------	----------------	------------	------	---	------

23040



JEEP GRAND CHEROKEE V-6, 3.7 L 2007 - 2009

23054



FORD MUSTANG V-8, 4.6 L 2007 - 2009

23041



DODGE DAKOTA V-6, 3.7 L 2008 - 2009

23055



FORD MUSTANG V-8, 4.6 L 2007 - 2006

23042



DODGE DAKOTA V-6, 3.7 L 2008 - 2007

23064



MITSUBISHI OUTLANDER 4 CIL, 2.4 L 2005 - 2005

23050



FORD MUSTANG V-6, 4.0 L 2007 - 2009

23068



DODGE RAM 2500 V-8, 5.7 L 2008 - 2008

23053



FORD MUSTANG V-8, 4.6 L 2007 - 2006

DODGE RAM 3500 V-8, 5.7 L 2007 - 2003

23074



VOLKSWAGEN	BORA SPORTWAGEN	5 CIL. 2.5 L	2008	-	2009
VOLKSWAGEN	BORA	5 CIL. 2.5 L	2009	-	2009
VOLKSWAGEN	BORA	5 CIL. 2.5 L	2008	-	2005

23122



PONTIAC	G6	V-6, 3.5 L	2008	-	2007
PONTIAC	G6	V-6, 3.9 L	2006	-	2006
CHEVROLET	MALIBU	V-6, 3.5 L	2007	-	2007

23075



VOLKSWAGEN	BORA	5 CIL. 2.5 L	2008	-	2005
VOLKSWAGEN	BORA	5 CIL. 2.5 L	2009	-	2009
VOLKSWAGEN	BORA SPORTWAGEN	5 CIL. 2.5 L	2008	-	2009

23124



PONTIAC	G6	V-6, 3.5 L	2007	-	2007
PONTIAC	G6	V-6, 3.9 L	2006	-	2006
CHEVROLET	MALIBU	V-6, 3.5 L	2007	-	2007

23078



PONTIAC	MONTANA	V-6, 3.5 L	2006	-	2006
---------	---------	------------	------	---	------

23127



CHEVROLET	EXPRESS	V-8, 6.0 L	2008	-	2010
CHEVROLET	EXPRESS	V-8, 5.3 L	2008	-	2010

23079



PONTIAC	MONTANA	V-6, 3.5 L	2006	-	2006
---------	---------	------------	------	---	------

23128



CHEVROLET	EXPRESS CARGO VAN	V-6, 4.3 L	2007	-	2010
-----------	-------------------	------------	------	---	------

## Aplicación por Producto

23130



TOYOTA RAV 4 4 CIL, 2.4 L 2007 - 2008

23143



CHEVROLET SILVERADO V-6, 4.3 L 2008 - 2010

TOYOTA RAV 4 V-6, 3.5 L 2008 - 2010

23137



23145



PONTIAC TORRENT V-6, 3.4 L 2008 - 2006

TOYOTA YARIS 4 CIL, 1.5 L 2008 - 2010

23138



23146



CHEVROLET MALIBU 4 CIL, 2.2 L 2007 - 2007

TOYOTA YARIS 4 CIL, 1.5 L 2008 - 2010

23140



23153



CHEVROLET UPLANDER V-6, 3.9 L 2006 - 2009

PONTIAC MONTANA V-6, 3.9 L 2008 - 2006

TOYOTA CAMRY V-6, 3.5 L 2008 - 2011

23142



**23154**



TOYOTA CAMRY V-6, 3.5 L 2008 - 2011

**23157**



SUZUKI GRAND VITARA V-6, 2.7 L 2008 - 2006

**23158**



SUZUKI GRAND VITARA V-6, 2.7 L 2008 - 2006

**23163**



CHEVROLET HHR 4 CIL, 2.4 L 2008 - 2010

**23164**



CHEVROLET CAPTIVA 4 CIL, 2.4 L 2008 - 2010

CHEVROLET HHR 4 CIL, 2.4 L 2008 - 2006

**23165**



PONTIAC G4 4 CIL, 2.4 L 2006 - 2006

PONTIAC G4 4 CIL, 2.2 L 2006 - 2006

**23166**



PONTIAC G4 4 CIL, 2.4 L 2006 - 2006

PONTIAC G4 4 CIL, 2.2 L 2006 - 2006

**23167**



FORD FIVE HUNDRED V-6, 3.0 L 2007 - 2007

**23169**



FORD FIVE HUNDRED V-6, 3.0 L 2007 - 2007



## Aplicación por Producto

23172



TOYOTA	CAMRY	4 CIL, 2.4 L	2008	-	2009
--------	-------	--------------	------	---	------

23184



SUBARU	B9 TRIBECA	6 CIL, 3.0 L	2007	-	2006
--------	------------	--------------	------	---	------

23174



GMC	SIERRA	V-8, 6.2 L	2009	-	2010
GMC	YUKON	V-8, 6.2 L	2009	-	2010
CHEVROLET	AVALANCHE	V-8, 5.3 L	2008	-	2010
CHEVROLET	TAHOE	V-8, 4.8 L	2007	-	2006
CHEVROLET	SILVERADO	V-8, 4.8 L	2008	-	2010
CHEVROLET	TAHOE	V-8, 5.3 L	2008	-	2010
CHEVROLET	SUBURBAN	V-8, 6.0 L	2008	-	2007
GMC	SIERRA	V-8, 5.3 L	2009	-	2010
CHEVROLET	SUBURBAN	V-8, 5.3 L	2008	-	2010
CHEVROLET	SILVERADO	V-8, 5.3 L	2008	-	2010
CADILLAC	ESCALADE	V-8 6.2 L	2007	-	2010

SUBARU	B9 TRIBECA	6 CIL, 3.0 L	2007	-	2006
--------	------------	--------------	------	---	------

23177



23230



FORD	FIVE HUNDRED	V-6, 3.0 L	2007	-	2006
------	--------------	------------	------	---	------

HYUNDAI	ATTITUDE	4 CIL, 1.4 L	2008	-	2010
HYUNDAI	ATTITUDE	4 CIL, 1.6 L	2008	-	2010
HYUNDAI	ATTITUDE	4 CIL, 1.6 L	2006	-	2007

23178



23233



TOYOTA	CAMRY	4 CIL, 2.4 L	2008	-	2009
--------	-------	--------------	------	---	------

TOYOTA	CAMRY	4 CIL, 2.5 L	2010	-	2011
--------	-------	--------------	------	---	------

23179



JEEP	WRANGLER	V-6, 3.8 L	2008	-	2010
------	----------	------------	------	---	------

23234



JEEP ..... WRANGLER ..... V-6, 3.8 L ..... 2008 - 2010

23265



ACURA ..... TL ..... V-6, 3.2 L ..... 2006 - 2006

23251



NISSAN	FRONTIER	V-6, 4.0 L	2007 - 2007
NISSAN	XTERRA	V-6, 4.0 L	2007 - 2007
NISSAN	FRONTIER	V-6, 4.0 L	2008 - 2008
NISSAN	PATHFINDER	V-6, 4.0 L	2007 - 2010

23266



FORD ..... F-450 SUPER DUTY ..... V-10, 6.8 L ..... 2007 - 2007

23252



NISSAN	FRONTIER	V-6, 4.0 L	2008 - 2008
NISSAN	PATHFINDER	V-6, 4.0 L	2007 - 2010
NISSAN	FRONTIER	V-6, 4.0 L	2007 - 2007
NISSAN	XTERRA	V-6, 4.0 L	2007 - 2007

23267



FORD ..... F-150 ..... V-6, 4.2 L ..... 2008 - 2008

23264



ACURA ..... TL ..... V-6, 3.2 L ..... 2006 - 2006

23271



FORD	ESCAPE	V-6, 3.0 L	2005 - 2009
MERCURY	MARINER	V-6, 3.0 L	2007 - 2009

23273



## Aplicación por Producto

FORD F-350 SUPER DUTY V-8, 5.4 L 2007 - 2009

**23274**



FORD F-150 V-6, 4.2 L 2008 - 2008

**23275**



FORD F-450 SUPER DUTY V-10, 6.8 L 2007 - 2007

**23276**



FORD FOCUS 4 CIL, 2.0 L 2008 - 2009

SUZUKI SWIFT 4 CIL, 1.6 L 2009 - 2009

**23280**

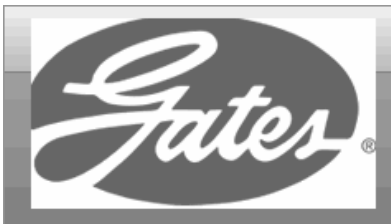

NISSAN TITAN V-8, 5.6 L 2009 - 2009

NISSAN ARMADA V-8, 5.6 L 2006 - 2010

**23281**



NISSAN TITAN V-8, 5.6 L 2009 - 2009

NISSAN ARMADA V-8, 5.6 L 2006 - 2010

**23284**



TOYOTA SIENNA V-6, 3.5 L 2007 - 2010

**23285**



NISSAN SENTRA 4 CIL, 2.0 L 2008 - 2010

**23286**



NISSAN SENTRA 4 CIL, 2.0 L 2008 - 2010

**23288**



## Aplicación por Producto

NISSAN	MURANO	V-6, 3.5 L	2008 - 2005
NISSAN	QUEST	V-6, 3.5 L	2008 - 2009

**23297**



FORD	FOCUS	4 CIL, 2.0 L	2008 - 2009
------	-------	--------------	-------------

**23298**



TOYOTA	SIENNA	V-6, 3.5 L	2007 - 2010
--------	--------	------------	-------------

**23299**



TOYOTA	RAV 4	4 CIL, 2.4 L	2007 - 2008
--------	-------	--------------	-------------

**23301**



TOYOTA	RAV 4	V-6, 3.5 L	2008 - 2010
--------	-------	------------	-------------

**23306**



NISSAN	TIIDA	4 CIL, 1.8 L	2008 - 2010
--------	-------	--------------	-------------

**23289**



NISSAN	MURANO	V-6, 3.5 L	2008 - 2005
--------	--------	------------	-------------

**23290**



MINI	COOPER	4 CIL, 1.6 L	2005 - 2007
------	--------	--------------	-------------

**23293**



GMC	ACADIA	V-6, 3.6 L	2009 - 2010
CHEVROLET	TRAVERSE	V-6, 3.6 L	2010 - 2011
BUICK	ENCLAVE	V-6, 3.6 L	2010 - 2010

**23294**



CHEVROLET	TRAVERSE	V-6, 3.6 L	2010 - 2011
GMC	ACADIA	V-6, 3.6 L	2009 - 2010
BUICK	ENCLAVE	V-6, 3.6 L	2010 - 2010

**23307**



NISSAN	TIIDA	4 CIL, 1.8 L	2008	-	2010
--------	-------	--------------	------	---	------

**23318**



HONDA	RIDGELINE	V-6, 3.5 L	2006	-	2007
-------	-----------	------------	------	---	------

**23309**



TOYOTA	SEQUOIA	V-8, 5.7 L	2009	-	2010
TOYOTA	TUNDRA	V-8, 5.7 L	2009	-	2010

**23319**



HONDA	PILOT	V-6, 3.5 L	2006	-	2008
ACURA	MDX	V-6, 3.5 L	2006	-	2006

**23310**



TOYOTA	TUNDRA	V-8, 5.7 L	2009	-	2010
TOYOTA	SEQUOIA	V-8, 5.7 L	2009	-	2010

**23320**



ACURA	MDX	V-6, 3.5 L	2006	-	2006
HONDA	PILOT	V-6, 3.5 L	2006	-	2008

**23317**



HONDA	RIDGELINE	V-6, 3.5 L	2006	-	2007
-------	-----------	------------	------	---	------

**23326**



HONDA	CIVIC	4 CIL, 1.8 L	2008	-	2010
-------	-------	--------------	------	---	------



23327



HONDA ..... CIVIC HIBRIDO ..... 4 CIL, 1.3 L ..... 2005 - 2010

23332



HONDA ..... CIVIC HIBRIDO ..... 4 CIL, 1.3 L ..... 2005 - 2010

23337



CHEVROLET ..... MALIBU ..... V-6, 3.6 L ..... 2008 - 2010

23338



CHEVROLET ..... MALIBU ..... V-6, 3.6 L ..... 2008 - 2010

23339



NISSAN ..... 370Z ..... V-6, 3.7 L ..... 2009 - 2009

23340



NISSAN ..... 370Z ..... V-6, 3.7 L ..... 2009 - 2009

23341



HONDA ..... CIVIC HIBRIDO ..... 4 CIL, 1.3 L ..... 2005 - 2010

23342



HONDA ..... CIVIC ..... 4 CIL, 1.8 L ..... 2008 - 2010

23343



NISSAN ..... 350Z ..... V-6, 3.5 L ..... 2007 - 2009

23344



## Aplicación por Producto

NISSAN 350Z V-6, 3.5 L 2007 - 2009

23350

23345



NISSAN ALTIMA V-6, 3.5 L 2008 - 2009

NISSAN MAXIMA V-6, 3.5 L 2009 - 2009

NISSAN ALTIMA 4 CIL, 2.5 L 2008 - 2009

23351

23346



NISSAN MAXIMA V-6, 3.5 L 2009 - 2009

NISSAN ALTIMA V-6, 3.5 L 2008 - 2009

NISSAN FRONTIER 4 CIL, 2.5 L 2007 - 2007

23352

23347

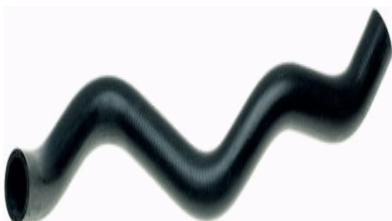

NISSAN FRONTIER 4 CIL, 2.5 L 2007 - 2007

NISSAN MAXIMA V-6, 3.5 L 2009 - 2009

NISSAN ALTIMA V-6, 3.5 L 2008 - 2009

23348



23353



NISSAN ALTIMA 4 CIL, 2.5 L 2008 - 2009

SUZUKI SX4 4 CIL, 2.0 L 2008 - 2010

NISSAN MAXIMA V-6, 3.5 L 2009 - 2009

NISSAN ALTIMA 4 CIL, 2.5 L 2009 - 2009

NISSAN ALTIMA V-6, 3.5 L 2009 - 2009

23354



SUZUKI	SX4	4 CIL, 2.0 L	2008	-	2010
--------	-----	--------------	------	---	------

23364



FORD	EXPLORER	V-6, 4.0 L	2007	-	2009
FORD	EXPLORER SPORT TRAC	V-6, 4.0 L	2007	-	2009

23361



FORD	EXPLORER	V-8, 4.6 L	2007	-	2007
FORD	EXPLORER SPORT TRAC	V-8, 4.6 L	2007	-	2007

23365



MAZDA	MAZDA 3	4 CIL, 2.0 L	2006	-	2008
MAZDA	MAZDA 3	4 CIL, 2.3 L	2006	-	2009

23362



FORD	EXPLORER SPORT TRAC	V-8, 4.6 L	2007	-	2009
FORD	EXPLORER	V-8, 4.6 L	2007	-	2009

23367



FORD	MUSTANG	V-8, 4.6 L	2008	-	2009
------	---------	------------	------	---	------

23363



FORD	EXPLORER	V-6, 4.0 L	2007	-	2009
FORD	EXPLORER SPORT TRAC	V-6, 4.0 L	2007	-	2009

23373



MINI	COOPER	4 CIL, 1.6 L	2005	-	2007
------	--------	--------------	------	---	------

23374



MINI ..... COOPER ..... 4 CIL, 1.6 L ..... 2005 - 2007

23375



MINI ..... COOPER ..... 4 CIL, 1.6 L ..... 2005 - 2007

23376



MINI ..... COOPER ..... 4 CIL, 1.6 L ..... 2005 - 2007

23377



MINI ..... COOPER ..... 4 CIL, 1.6 L ..... 2005 - 2007

23378



MINI ..... COOPER ..... 4 CIL, 1.6 L ..... 2005 - 2007

23383



CHEVROLET EXPRESS ..... V-8, 5.3 L ..... 2008 - 2010  
 CHEVROLET EXPRESS ..... V-8, 6.0 L ..... 2008 - 2010

23384



CHEVROLET HHR ..... 4 CIL, 2.4 L ..... 2009 - 2010

23386



SUZUKI ..... XL-7 ..... V-6, 3.6 L ..... 2007 - 2009

23387



SUZUKI ..... XL-7 ..... V-6, 3.6 L ..... 2007 - 2009

23388



HONDA CR-V 4 CIL, 2.4 L 2007 - 2009

23389



HONDA CR-V 4 CIL, 2.4 L 2007 - 2009

23390



HONDA ODYSSEY V-6, 3.5 L 2007 - 2010

23391



HONDA ODYSSEY V-6, 3.5 L 2007 - 2010

23393



ACURA RL V-6, 3.5 L 2006 - 2008

23394



ACURA RL V-6, 3.5 L 2006 - 2008

23395



HONDA ODYSSEY V-6, 3.5 L 2005 - 2006

23396



HONDA ODYSSEY V-6, 3.5 L 2005 - 2006

23397



ACURA TL V-6, 3.5 L 2008 - 2008

ACURA TL V-6, 3.2 L 2007 - 2008



## Aplicación por Producto

23399

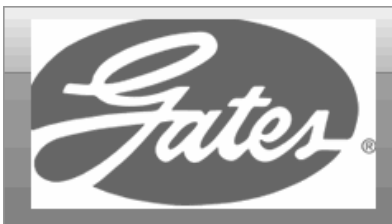

ACURA	TL	V-6, 3.5 L	2008	-	2008
ACURA	TL	V-6, 3.2 L	2007	-	2008

23406



NISSAN	MURANO	V-6, 3.5 L	2009	-	2010
--------	--------	------------	------	---	------

23410



DODGE	NITRO	V-6, 3.7 L	2007	-	2010
-------	-------	------------	------	---	------

23411



DODGE	NITRO	V-6, 3.7 L	2007	-	2010
-------	-------	------------	------	---	------

23412



MITSUBISHI	OUTLANDER	V-6, 3.0 L	2007	-	2008
------------	-----------	------------	------	---	------

23424



MITSUBISHI	OUTLANDER	V-6, 3.0 L	2007	-	2008
------------	-----------	------------	------	---	------

23425



MITSUBISHI	OUTLANDER	V-6, 3.0 L	2007	-	2008
------------	-----------	------------	------	---	------

23429



DODGE	NITRO	V-6, 4.0 L	2009	-	2010
-------	-------	------------	------	---	------

23431



CHEVROLET	MALIBU	4 CIL, 2.4 L	2008	-	2010
-----------	--------	--------------	------	---	------

23438



HUMMER H2 V-8, 6.2 L 2008 - 2010

23439



HUMMER H2 V-8, 6.2 L 2008 - 2010

23443



FORD FUSION 4 CIL, 2.3 L 2007 - 2009

23444



FORD EDGE V-6, 3.5 L 2007 - 2010

23445



FORD EDGE V-6, 3.5 L 2007 - 2010

23454



CHRYSLER 300 C V-6, 3.5 L 2007 - 2009  
DODGE CHARGER V-6, 3.5 L 2009 - 2009

23455



TOYOTA HIGHLANDER V-6, 3.5 L 2008 - 2009

23456



TOYOTA HIGHLANDER V-6, 3.5 L 2008 - 2009

23457



TOYOTA LAND CRUISER V-8, 5.7 L 2008 - 2010

23458



TOYOTA LAND CRUISER V-8, 5.7 L 2008 - 2010

23464



CHRYSLER TOWN & COUNTRY V6, 4.0 L 2008 - 2010

23465



CHRYSLER TOWN & COUNTRY V6, 4.0 L 2008 - 2010

23472



CHEVROLET MALIBU 4 CIL, 2.4 L 2008 - 2010

23476



CHEVROLET ASTRA 4 CIL, 1.8 L 2007 - 2009

23479



NISSAN ROGUE 4 CIL, 2.5 L 2008 - 2010

23480



NISSAN ROGUE 4 CIL, 2.5 L 2008 - 2010

23487



SUZUKI SWIFT 4 CIL, 1.6 L 2009 - 2009

23490



CHEVROLET CAPTIVA V-6, 3.6 L 2008 - 2010

23491



## Aplicación por Producto

CHEVROLET MALIBU 4 CIL, 2.4 L 2008 - 2010

**23529**



**23495**



TOYOTA MATRIX 4 CIL, 2.4 L 2009 - 2010

TOYOTA COROLLA 4 CIL, 2.4 L 2009 - 2010

CHEVROLET CAPTIVA V-6, 3.6 L 2008 - 2010

**23583**



**23517**



SUZUKI GRAND VITARA 4 CIL, 2.4 L 2009 - 2010

HONDA ODYSSEY V-6, 3.5 L 2008 - 2010

**23584**



**23518**



SUZUKI GRAND VITARA V-6, 3.2 L 2009 - 2010

HONDA ACCORD V-6, 3.5 L 2008 - 2010

**23586**



**23528**



SUZUKI GRAND VITARA V-6, 3.2 L 2009 - 2010

TOYOTA MATRIX 4 CIL, 2.4 L 2009 - 2010

TOYOTA COROLLA 4 CIL, 2.4 L 2009 - 2010

**24022**



2 1/2"

## Aplicación por Producto

JAGUAR	S-TYPE	V-8, 4.0 L	2002	-	2002
LINCOLN	LS	V-8, 3.9 L	2002	-	2002

**28408**

**24026**



FORD	ESCAPE	V-6, 3.0 L	2004	-	2004
FORD	ESCAPE	V-6, 3.0 L	2003	-	2002

**25150**



HONDA	CIVIC	4 CIL, 1.6 L	1999	-	1999
-------	-------	--------------	------	---	------

**25265**



CHEVROLET	C y K SERIES PICKUP	V-8, 5.0 L	1999	-	1999
-----------	---------------------	------------	------	---	------

**25302**



DODGE	ADVENTURER	V-6, 3.3 L	1995	-	1995
-------	------------	------------	------	---	------



CHEVROLET	EXPRESS	V-8, 6.0 L	2004	-	2004
CHEVROLET	TRACKER	V-6, 2.5 L	2003	-	2002
CHEVROLET	MALIBU	V-6, 3.1 L	2003	-	2002
CHEVROLET	EXPRESS	V-8, 5.3 L	2004	-	2004
CHEVROLET	TRACKER	4 CIL, 2.0 L	2003	-	2002
CHEVROLET	TRACKER	V-6, 2.5 L	2003	-	2002
CHEVROLET	TRACKER	V-6, 2.5 L	2003	-	2002
PONTIAC	GRAND AM	V-6, 3.4 L	2003	-	2002
PONTIAC	SUNFIRE	4 CIL, 2.2 L	2002	-	2002
CHEVROLET	TRAILBLAZER	V-8, 5.3 L	2003	-	2003
PONTIAC	GRAND AM	V-6, 3.4 L	2004	-	2004
CHEVROLET	SUBURBAN	V-8, 5.3 L	2003	-	2002
CADILLAC	ESCALADE	V-8, 5.3 L	2004	-	2004
JAGUAR	S-TYPE	V-8, 4.0 L	2002	-	2002
CHEVROLET	SUBURBAN	V-8, 6.0 L	2002	-	2002
CHEVROLET	TRACKER	V-6, 2.5 L	2003	-	2002
CHEVROLET	IMPALA	V-6, 3.4 L	2004	-	2004
CHEVROLET	CAVALIER	4 CIL, 2.2 L	2002	-	2002
MERCURY	SABLE / TAURUS	V-6, 3.0 L	2002	-	2002
TOYOTA	COROLLA	4 CIL, 1.8 L	2002	-	2002
TOYOTA	CAMRY	V-6, 3.0 L	2002	-	2002
CHEVROLET	SUBURBAN	V-8, 5.3 L	2004	-	2004
PONTIAC	SUNFIRE	4 CIL, 2.2 L	2002	-	2002
CHEVROLET	AVALANCHE	V-8, 5.3 L	2003	-	2002
CHEVROLET	AVALANCHE	V-8, 5.3 L	2004	-	2004
CHEVROLET	TRACKER	V-6, 2.5 L	2003	-	2002
PONTIAC	GRAND AM	V-6, 3.4 L	2003	-	2002
CADILLAC	ESCALADE	V-8, 6.0 L	2004	-	2004
LINCOLN	LS	V-8, 3.9 L	2002	-	2002

**28461**



CHEVROLET	TRACKER	V-6, 2.5 L	2004	-	2002
-----------	---------	------------	------	---	------

28466



FORD	EXPEDITION	V-8, 5.4 L	2002	-	2002
TOYOTA	LAND CRUISER	V-8, 4.7 L	2004	-	2003
CHEVROLET	S-10	4 CIL, 2.2 L	2003	-	2002
CHEVROLET	EXPRESS	V-8, 6.0 L	2007	-	2004
CHEVROLET	EXPRESS	V-8, 5.3 L	2007	-	2004
CHEVROLET	EXPRESS	V-6, 4.3 L	2003	-	2002
CHEVROLET	EXPRESS	V-6, 4.3 L	2003	-	2003
CHEVROLET	EXPRESS	V-6, 4.3 L	2003	-	2002
FORD	EXPEDITION	V-8, 4.6 L	2002	-	2002
CHEVROLET	EXPRESS	V-8, 5.7 L	2002	-	2002
FORD	F-150	V-6, 4.2 L	2006	-	2002
FORD	ESCORT	4 CIL, 2.0 L	2001	-	1998
MERCURY	SABLE / TAURUS	V-6, 3.0 L	2002	-	2002

28467



CHEVROLET	EXPRESS	V-6, 4.3 L	2003	-	2002
-----------	---------	------------	------	---	------

28468



CHEVROLET	EXPRESS	V-8, 5.7 L	2002	-	2002
-----------	---------	------------	------	---	------

28469



CHEVROLET	S-10	4 CIL, 2.2 L	2002	-	2002
FORD	F SERIES PICKUP	V-6, 4.2 L	2002	-	2002

28474



CHEVROLET	VENTURE	V-6, 3.4 L	2004	-	2002
CHEVROLET	EXPRESS	V-6, 4.3 L	2003	-	2002
NISSAN	MAXIMA	V-6, 3.0 L	2000	-	1998
INFINITI	INFINITI I30	V-6, 3.0 L	2000	-	1998

28475



CORTAR A MEDIDA

JAGUAR	S-TYPE	V-8, 4.0 L	2005	-	2003
CHEVROLET	EXPRESS	V-6, 4.3 L	2003	-	2002
JAGUAR	S-TYPE	V-8, 4.0 L	2002	-	2002
LINCOLN	LS	V-8, 3.9 L	2002	-	2002
CHEVROLET	EXPRESS	V-8, 5.7 L	2002	-	2002

28500



CHEVROLET	TRAILBLAZER	6 CIL, 4.2 L	2004	-	2004
PONTIAC	GRAND AM	V-6, 3.4 L	2004	-	2004
PONTIAC	AZTEK	V-6, 3.4 L	2004	-	2004



## Aplicación por Producto

### 30T 3/4"



3"

CADILLAC	DEVILLE	V-8, 4.6 L	2003	-	2002
CHRYSLER	300M	V-6, 3.5 L	2003	-	2002
CHEVROLET	EXPRESS	V-6, 4.3 L	2003	-	2002
CHEVROLET	CORVETTE	V-8, 5.7 L	2003	-	2002
CHRYSLER	CONCORDE	V-6, 3.5 L	2002	-	2002
CHEVROLET	EXPRESS	V-8, 5.7 L	2002	-	2002
CHEVROLET	EXPRESS	V-6, 4.3 L	2003	-	2002
CHEVROLET	SUBURBAN	V-8, 5.3 L	2003	-	2002
CHEVROLET	SUBURBAN	V-8, 8.1 L	2002	-	2002
CHEVROLET	SUBURBAN	V-8, 6.0 L	2002	-	2002
NISSAN	PATHFINDER	V-6, 3.5 L	2002	-	2002
CHEVROLET	S-10	4 CIL, 2.2 L	2002	-	2002

### 30T 5/8"



15"

DODGE	RAM MAXI WAGON 3500	V-8, 5.9 L	2002	-	2002
DODGE	RAM MAXI WAGON 3500	V-8, 5.9 L	2002	-	2002
DODGE	RAM MAXI WAGON 3500	V-8, 5.9 L	2002	-	2002
DODGE	RAM MAXI VAN 2500	V-8, 5.2 L	2002	-	2002
CHRYSLER	TOWN & COUNTRY	V-6, 3.8 L	2003	-	2002
DODGE	RAM MAXI VAN 2500	V-8, 5.2 L	2002	-	2002
DODGE	RAM MAXI WAGON 3500	V-8, 5.9 L	2002	-	2002
DODGE	RAM MAXI VAN 2500	V-8, 5.2 L	2002	-	2002
DODGE	RAM MAXI VAN 3500	V-8, 5.9 L	2002	-	2002
CHRYSLER	TOWN & COUNTRY	V-6, 3.8 L	2003	-	2002
DODGE	RAM MAXI WAGON 3500	V-8, 5.9 L	2002	-	2002
DODGE	RAM MAXI WAGON 3500	V-8, 5.9 L	2002	-	2002
CHEVROLET	EXPRESS	V-6, 4.3 L	2003	-	2002
DODGE	RAM MAXI WAGON 3500	V-8, 5.9 L	2002	-	2002
DODGE	RAM MAXI WAGON 3500	V-8, 5.9 L	2002	-	2002
DODGE	RAM MAXI VAN 1500	V-6, 3.9 L	2002	-	2002
DODGE	RAM MAXI VAN 1500	V-6, 3.9 L	2002	-	2002
DODGE	NEON	4 CIL, 2.0 L	2002	-	2002
DODGE	RAM MAXI VAN 1500	V-6, 3.9 L	2002	-	2002
DODGE	RAM MAXI VAN 2500	V-8, 5.2 L	2002	-	2002
LINCOLN	TOWN CAR	V-8, 4.6 L	2002	-	2002

FORD	WINDSTAR	V-6, 3.8 L	2003	-	2002
CHRYSLER	VOYAGER	V-6, 3.3 L	2002	-	2002
DODGE	RAM MAXI VAN 1500	V-6, 3.9 L	2002	-	2002
DODGE	RAM MAXI WAGON 3500	V-8, 5.9 L	2002	-	2002
DODGE	RAM MAXI VAN 3500	V-8, 5.9 L	2002	-	2002
DODGE	RAM MAXI VAN 3500	V-8, 5.9 L	2002	-	2002
DODGE	RAM MAXI VAN 3500	V-8, 5.9 L	2002	-	2002
DODGE	RAM MAXI VAN 3500	V-8, 5.9 L	2002	-	2002
DODGE	RAM WAGON 3500	V-8, 5.9 L	2002	-	2002
DODGE	RAM WAGON 3500	V-8, 5.9 L	2002	-	2002
DODGE	RAM WAGON 3500	V-8, 5.9 L	2002	-	2002
DODGE	RAM WAGON 3500	V-8, 5.9 L	2002	-	2002
DODGE	RAM WAGON 3500	V-8, 5.9 L	2002	-	2002
HONDA	ACCORD	V-6, 3.0 L	2002	-	2002
CHRYSLER	TOWN & COUNTRY	V-6, 3.8 L	2003	-	2002
MERCURY	SABLE / TAURUS	V-6, 3.0 L	2002	-	2002
DODGE	RAM MAXI VAN 1500	V-6, 3.9 L	2002	-	2002
CHRYSLER	PT CRUISER	4 CIL, 2.4 L	2002	-	2002
CHEVROLET	SUBURBAN	V-8, 8.1 L	2002	-	2002
CHRYSLER	PT CRUISER	4 CIL, 2.4 L	2002	-	2002
DODGE	RAM MAXI VAN 3500	V-8, 5.9 L	2002	-	2002
DODGE	NEON	4 CIL, 2.0 L	2002	-	2002
CHRYSLER	TOWN & COUNTRY	V-6, 3.8 L	2003	-	2002
DODGE	RAM MAXI VAN 3500	V-8, 5.9 L	2002	-	2002
DODGE	RAM MAXI VAN 3500	V-8, 5.9 L	2002	-	2002
DODGE	RAM MAXI VAN 3500	V-8, 5.9 L	2002	-	2002
DODGE	RAM MAXI VAN 1500	V-6, 3.9 L	2002	-	2002
DODGE	RAM WAGON 3500	V-8, 5.9 L	2002	-	2002
DODGE	RAM WAGON 3500	V-8, 5.9 L	2002	-	2002
CHRYSLER	VOYAGER	V-6, 3.3 L	2002	-	2002
CHEVROLET	TRAILBLAZER	V-8, 5.3 L	2003	-	2003
HONDA	ACCORD	4 CIL, 2.3 L	2002	-	2002
FORD	EXPLORER	V-8, 4.6 L	2003	-	2002
DODGE	RAM MAXI VAN 2500	V-8, 5.2 L	2002	-	2002
DODGE	RAM MAXI VAN 2500	V-8, 5.2 L	2002	-	2002
CHRYSLER	VOYAGER	V-6, 3.3 L	2002	-	2002
CHEVROLET	TRAILBLAZER	V-8, 5.3 L	2003	-	2003
CHRYSLER	VOYAGER	V-6, 3.3 L	2002	-	2002
FORD	EXPLORER	V-6, 4.0 L	2002	-	2002
CHEVROLET	CORVETTE	V-8, 5.7 L	2003	-	2002
DODGE	RAM SERIES PICKUP	V-8, 5.9 L	2002	-	2002
DODGE	RAM MAXI VAN 1500	V-6, 3.9 L	2002	-	2002
FORD	EXPEDITION	V-8, 4.6 L	2002	-	2002
DODGE	RAM MAXI VAN 1500	V-6, 3.9 L	2002	-	2002
DODGE	RAM WAGON 3500	V-8, 5.9 L	2002	-	2002
HONDA	ODYSSEY	V-6, 3.5 L	2002	-	2002
DODGE	RAM MAXI VAN 2500	V-8, 5.2 L	2002	-	2002
DODGE	RAM SERIES PICKUP	V-8, 5.9 L	2002	-	2002
DODGE	RAM MAXI VAN 2500	V-8, 5.2 L	2002	-	2002
DODGE	RAM MAXI VAN 1500	V-6, 3.9 L	2002	-	2002
CHEVROLET	CAMARO Z28	V-8, 5.7 L	2002	-	2002

## Aplicación por Producto

CHEVROLET	EXPRESS	V-8, 5.7 L	2002 - 2002
DODGE	RAM MAXI VAN 2500	V-8, 5.2 L	2002 - 2002

### 35B 1"



10"

TOYOTA	CAMRY	V-6, 3.0 L	2002 - 2002
--------	-------	------------	-------------

### 35B 1/2"

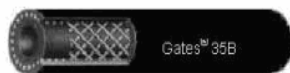

3"

NISSAN	XTERRA	V-6, 3.3 L	2002 - 2002
CHEVROLET	SUBURBAN	V-8, 5.3 L	2003 - 2002
CHEVROLET	SUBURBAN	V-8, 8.1 L	2002 - 2002
CHEVROLET	VENTURE	V-6, 3.4 L	2004 - 2002
CHEVROLET	SUBURBAN	V-8, 5.3 L	2004 - 2004
NISSAN	FRONTIER	V-6, 3.3 L	2002 - 2002
NISSAN	XTERRA	V-6, 3.3 L	2002 - 2002
CHEVROLET	AVALANCHE	V-8, 5.3 L	2004 - 2004
CHEVROLET	AVALANCHE	V-8, 5.3 L	2005 - 2005
CHEVROLET	AVALANCHE	V-8, 5.3 L	2003 - 2002
CADILLAC	ESCALADE	V-8, 6.0 L	2004 - 2004
CHEVROLET	SUBURBAN	V-8, 6.0 L	2002 - 2002
CADILLAC	ESCALADE	V-8, 5.3 L	2004 - 2004
NISSAN	FRONTIER	V-6, 3.3 L	2002 - 2002

### 35B 1/4"



19"

LINCOLN	NAVIGATOR	V-8, 5.4 L	2002 - 2002
LINCOLN	NAVIGATOR	V-8, 5.4 L	2002 - 2002
CHEVROLET	CAMARO Z28	V-8, 5.7 L	2002 - 2002
FORD	F SERIES PICKUP	V-6, 4.2 L	2002 - 2002
CHEVROLET	TRACKER	4 CIL, 2.0 L	2003 - 2002
CHEVROLET	TRACKER	4 CIL, 2.0 L	2003 - 2002

FORD	FOCUS	4 CIL, 2.0 L	2004 - 2004
CHEVROLET	TRACKER	4 CIL, 2.0 L	2003 - 2002
CHEVROLET	CORVETTE	V-8, 5.7 L	2004 - 2004
CHEVROLET	CORVETTE	V-8, 5.7 L	2003 - 2002
FORD	F SERIES PICKUP	V-6, 4.2 L	2002 - 2002

### 35B 3/4"



25"

CADILLAC	SRX	V-6, 3.6 L	2004 - 2004
CADILLAC	SRX	V-6, 3.6 L	2005 - 2005
CADILLAC	ESCALADE	V-8, 6.0 L	2004 - 2004
CHEVROLET	CORVETTE	V-8, 5.7 L	2004 - 2004
CHEVROLET	EXPRESS	V-8, 6.0 L	2004 - 2004
CADILLAC	SRX	V-8, 4.6 L	2004 - 2004
CHEVROLET	EXPRESS CARGO VAN	V-6, 4.3 L	2004 - 2004
CADILLAC	ESCALADE	V-8, 5.3 L	2004 - 2004
CHEVROLET	TRAILBLAZER	6 CIL, 4.2 L	2004 - 2004
CADILLAC	SRX	V-8, 4.6 L	2004 - 2004
CHEVROLET	EXPRESS	V-8, 5.3 L	2004 - 2004
CHEVROLET	SUBURBAN	V-8, 5.3 L	2004 - 2004

### 35B 3/8"



11"

FORD	LOBO	V-8, 5.4 L	2002 - 2002
PONTIAC	SUNFIRE	4 CIL, 2.2 L	2002 - 2002
MERCURY	SABLE / TAURUS	V-6, 3.0 L	2002 - 2002
MERCURY	SABLE / TAURUS	V-6, 3.0 L	2002 - 2002
MERCURY	GRAND MARQUIS	V-8, 4.6 L	2002 - 2002
FORD	F SERIES PICKUP	V-6, 4.2 L	2002 - 2002
CHEVROLET	MALIBU	4 CIL, 2.2 L	2004 - 2004
CHEVROLET	MALIBU	V-6, 3.1 L	2003 - 2002
CHEVROLET	MALIBU	V-6, 3.1 L	2003 - 2002
FORD	SUPER DUTY PICKUP	V-8, 7.3 L	2002 - 2002
PONTIAC	AZTEK	V-6, 3.4 L	2003 - 2002
FORD	RANGER	V-6, 3.0 L	2002 - 2002
PONTIAC	SUNFIRE	4 CIL, 2.2 L	2005 - 2005
PONTIAC	SUNFIRE	4 CIL, 2.2 L	2004 - 2004
PONTIAC	SUNFIRE	4 CIL, 2.2 L	2005 - 2005
PONTIAC	AZTEK	V-6, 3.4 L	2004 - 2004

## Aplicación por Producto

FORD	EXPEDITION	V-8, 5.4 L	2002	-	2002
CHEVROLET	CORVETTE	V-8, 5.7 L	2003	-	2002
CHEVROLET	CORVETTE	V-8, 5.7 L	2004	-	2004
CHEVROLET	EXPRESS	V-8, 5.3 L	2003	-	2003
PONTIAC	AZTEK	V-6, 3.4 L	2003	-	2002
FORD	EXPEDITION	V-8, 4.6 L	2002	-	2002
CHEVROLET	TRAILBLAZER	V-8, 5.3 L	2003	-	2003
CHEVROLET	EXPRESS	V-8, 5.7 L	2002	-	2002
CHEVROLET	TRAILBLAZER	V-8, 5.3 L	2003	-	2003
CHEVROLET	EXPRESS	V-8, 6.0 L	2004	-	2004
FORD	ESCAPE	V-6, 3.0 L	2003	-	2002
CHEVROLET	EXPRESS	V-8, 6.0 L	2003	-	2003
CHEVROLET	CAVALIER	4 CIL, 2.2 L	2005	-	2002
CHEVROLET	TRAILBLAZER	6 CIL, 4.2 L	2003	-	2002
CHEVROLET	TRAILBLAZER	6 CIL, 4.2 L	2004	-	2004
CHEVROLET	EXPRESS CARGO VAN	V-6, 4.3 L	2004	-	2004
LINCOLN	TOWN CAR	V-8, 4.6 L	2002	-	2002
FORD	EXPLORER	V-6, 4.0 L	2002	-	2002
CHEVROLET	S-10	4 CIL, 2.2 L	2002	-	2002
FORD	EXPLORER	V-8, 4.6 L	2003	-	2002
CHEVROLET	CAVALIER	4 CIL, 2.2 L	2004	-	2004
CHEVROLET	CAVALIER	4 CIL, 2.2 L	2005	-	2002
CHEVROLET	EXPRESS	V-8, 5.3 L	2004	-	2004
CHEVROLET	VENTURE	V-6, 3.4 L	2004	-	2002
LINCOLN	NAVIGATOR	V-8, 5.4 L	2002	-	2002
CHEVROLET	EXPRESS	V-6, 4.3 L	2003	-	2002
CHEVROLET	COLORADO	5 CIL, 3.5 L	2005	-	2005
PONTIAC	GRAND AM	V-6, 3.4 L	2003	-	2002
CHEVROLET	IMPALA	V-6, 3.4 L	2005	-	2005
CHEVROLET	COLORADO	4 CIL, 2.8 L	2005	-	2005
CHEVROLET	IMPALA	V-6, 3.8 L	2004	-	2004
CHEVROLET	IMPALA	V-6, 3.8 L	2005	-	2002
PONTIAC	GRAND AM	V-6, 3.4 L	2004	-	2004
FORD	ESCAPE	V-6, 3.0 L	2004	-	2004
CHEVROLET	IMPALA	V-6, 3.4 L	2004	-	2004
CHEVROLET	COLORADO	5 CIL, 3.5 L	2004	-	2004

### 35B 5/8"



CHEVROLET	EXPRESS	V-8, 5.3 L	2004	-	2004
VOLKSWAGEN	JETTA	4 CIL, 2.0 L	2005	-	2005
VOLKSWAGEN	JETTA	4 CIL, 2.0 L	2005	-	2005
CHEVROLET	EXPRESS CARGO VAN	V-6, 4.3 L	2004	-	2004
MERCURY	GRAND MARQUIS	V-8, 4.6 L	2002	-	2002
CHEVROLET	CORVETTE	V-8, 5.7 L	2004	-	2004
CHEVROLET	TRAILBLAZER	6 CIL, 4.2 L	2004	-	2004
FORD	FOCUS	4 CIL, 2.0 L	2004	-	2004
CHEVROLET	EXPRESS	V-8, 6.0 L	2004	-	2004
VOLKSWAGEN	GOLF	4 CIL, 2.0 L	2005	-	2005
VOLKSWAGEN	GOLF	4 CIL, 2.0 L	2005	-	2005

### CH-110021



1 1/4 x 24

DODGE	NEON	4 CIL, 2.0 L	1999	-	1995
DODGE	STRATUS	V-6, 2.5 L	1999	-	1995

### CH-110031



1 1/4 x 19

DODGE	STRATUS	V-6, 2.5 L	2000	-	2000
-------	---------	------------	------	---	------

### CH-110043



5/8 x 39

### 35B 5/16"

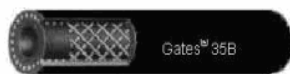

10"

CHEVROLET	TRACKER	V-6, 2.5 L	2004	-	2004
CHEVROLET	TRACKER	V-6, 2.5 L	2004	-	2004
CHEVROLET	TRACKER	V-6, 2.5 L	2004	-	2004
CHEVROLET	TRACKER	V-6, 2.5 L	2004	-	2004
CHEVROLET	TRACKER	V-6, 2.5 L	2004	-	2004
FORD	FOCUS	4 CIL, 2.0 L	2004	-	2004

## Aplicación por Producto

DODGE	STRATUS	V-6, 2.5 L	2000	-	2000
-------	---------	------------	------	---	------

**CH-110591**

**CH-110081**



1 x 18.5

HYUNDAI	ATOS	4 CIL, 1.0 L	2004	-	2000
HYUNDAI	ATOS	4 CIL, 1.1 L	2008	-	2010

**CH-110092**



1 x 34

HYUNDAI	ATOS	4 CIL, 1.1 L	2008	-	2010
HYUNDAI	ATOS	4 CIL, 1.0 L	2004	-	2000

**CH-110301**



1 1/4 x 16.5

DODGE	NEON	4 CIL, 2.0 L	1999	-	1995
-------	------	--------------	------	---	------

**CH-110312**



1 1/4 x 16.5

DODGE	NEON	4 CIL, 2.0 L	1999	-	1995
-------	------	--------------	------	---	------



1 1/2 x 23.5

DODGE	RAM CHARGER	V-8, 5.9 L	1993	-	1993
DODGE	RAM WAGON 2500	V-8, 5.9 L	1995	-	1994
DODGE	RAM WAGON 1500	V-6, 3.9 L	1997	-	1995
DODGE	RAM MAXI VAN 2500	V-8, 5.2 L	1999	-	1996
DODGE	RAM MAXI VAN 3500	V-8, 5.9 L	1997	-	1997
DODGE	RAM MAXI WAGON 3500	V-8, 5.2 L	1996	-	1995
DODGE	RAM MAXI WAGON 3500	V-8, 5.9 L	1997	-	1995

**CH-111182**



1 1/4 x 39

CHRYSLER	LEBARON	4 CIL, 2.5 L	1994	-	1993
----------	---------	--------------	------	---	------

**CH-111191**



1 1/2 x 27

DODGE	D-250	V-8, 5.9 L	1993	-	1993
-------	-------	------------	------	---	------

**CH-111302**



1 3/4 x 18

DODGE	D-250	V-8, 5.9 L	1993	-	1993
-------	-------	------------	------	---	------

### CH-111311



1 x 18

CHRYSLER	PHANTOM	4 CIL, 2.5 L	1993	-	1993
DODGE	SPIRIT	4 CIL, 2.5 L	1994	-	1993

### CH-111332



1 1/4 x 35

DODGE	SPIRIT	4 CIL, 2.5 L	1994	-	1993
-------	--------	--------------	------	---	------

### CH-114581



2 x 31.75

DODGE	RAM 6500 DIESEL	PERKINS F-IV 6L-1997	-	1994
DODGE	RAM SERIES PICKUP	PERKINS F-IV 6L-1997	-	1994

### CH-114582



2 1/8 x 18.75

DODGE	RAM 6500 DIESEL	PERKINS F-IV 6L-1997	-	1994
DODGE	RAM SERIES PICKUP	PERKINS F-IV 6L-1997	-	1994

### CH-115591



1 1/2 x 40

DODGE	RAM CHARGER	V-8, 5.9 L	2001	-	1993
DODGE	RAM MAXI VAN 2500	V-8, 5.2 L	1999	-	1996
DODGE	RAM MAXI VAN 3500	V-8, 5.9 L	1999	-	1999
DODGE	RAM 4000	V-8, 5.9 L	2001	-	1995
DODGE	RAM WAGON 3500	V-8, 5.2 L	2001	-	2000
DODGE	RAM SERIES PICKUP	V-8, 5.9 L	2001	-	1994
DODGE	RAM WAGON 2500	V-8, 5.2 L	2001	-	2001
DODGE	RAM MAXI WAGON 3500	V-8, 5.9 L	2000	-	1998
DODGE	RAM 2500	V-8, 5.9 L	2000	-	1994
DODGE	RAM 3500	V-8, 5.9 L	2001	-	1994
DODGE	RAM 2500	V-8, 5.2 L	2000	-	1995
DODGE	RAM SERIES PICKUP	V-8, 5.2 L	2000	-	1995

### CH-116391



1 1/2 x 41

DODGE	RAM 1500	V-6, 3.9 L	2000	-	1994
DODGE	RAM WAGON 1500	V-6, 3.9 L	2001	-	2001
DODGE	RAM MAXI VAN 1500	V-6, 3.9 L	1999	-	1995
DODGE	RAM SERIES PICKUP	V-6, 3.9 L	2001	-	1994

### CH-116392



1 3/4 x 32

DODGE	RAM 1500	V-6, 3.9 L	1997	-	1994
DODGE	RAM SERIES PICKUP	V-6, 3.9 L	1997	-	1994

### CH-117592



1 3/4 x 32.5

DODGE	RAM CHARGER	V-8, 5.9 L	2001	-	1993
DODGE	RAM 2500	V-8, 5.9 L	2000	-	1994
DODGE	RAM 3500	V-8, 5.9 L	2001	-	1994
DODGE	RAM 2500	V-8, 5.2 L	2000	-	1995
DODGE	RAM 4000	V-8, 5.9 L	2001	-	1995
DODGE	RAM SERIES PICKUP	V-8, 5.9 L	2001	-	1994
DODGE	RAM WAGON 2500	V-8, 5.2 L	2001	-	2001
DODGE	RAM WAGON 3500	V-8, 5.2 L	2001	-	2000
DODGE	RAM MAXI VAN 2500	V-8, 5.2 L	1999	-	1996
DODGE	RAM MAXI VAN 3500	V-8, 5.9 L	1999	-	1999
DODGE	RAM MAXI WAGON 3500	V-8, 5.9 L	2000	-	1998
DODGE	RAM SERIES PICKUP	V-8, 5.2 L	2000	-	1995

### CH-119401



HYUNDAI	H100	4 CIL, 2.4 L	2003	-	2005
---------	------	--------------	------	---	------

### CH-119402



HYUNDAI	H100	4 CIL, 2.4 L	2003	-	2005
---------	------	--------------	------	---	------

### CH-118251



1 x 19

DODGE	SPIRIT	4 CIL, 2.5 L	1993	-	1993
CHRYSLER	LEBARON	4 CIL, 2.5 L	1994	-	1993

### CH-119411



HYUNDAI	H100	4 CIL, 2.5 L DIESE2006	-	-	2010
---------	------	------------------------	---	---	------

### CH-119412



HYUNDAI	H100	4 CIL, 2.5 L DIESE2006	-	-	2010
---------	------	------------------------	---	---	------

### CH-118252



1 1/4 x 40.5

DODGE	SPIRIT	4 CIL, 2.5 L	1993	-	1993
-------	--------	--------------	------	---	------

### CH-130011



1 1/2 x 66.63

FORD	F-150	V-6, 4.9 L	1997	-	1995
------	-------	------------	------	---	------



## Aplicación por Producto

FORD	F SERIES PICKUP	V-6, 4.9 L	1997	-	1995
------	-----------------	------------	------	---	------

**CH-130132**



3/4 x 33

FORD	KA	4 CIL, 1.6 L	2005	-	2007
------	----	--------------	------	---	------

**CH-130022**



1 1/4 x 13

FORD	ESCORT	4 CIL, 1.8 L	1996	-	1994
------	--------	--------------	------	---	------

**CH-130142**



3/4 x 9

FORD	KA	4 CIL, 1.6 L	2002	-	2007
------	----	--------------	------	---	------

**CH-130041**



1 1/4 x 17.25

FORD	ESCORT	4 CIL, 1.9 L	1996	-	1994
------	--------	--------------	------	---	------

FORD	ESCORT	4 CIL, 2.0 L	2001	-	1997
------	--------	--------------	------	---	------

**CH-130151**



1 x 26.75

FORD	FIESTA	4 CIL, 1.4 L	2003	-	1999
------	--------	--------------	------	---	------

**CH-130052**



1 3/16 x 14

MERCURY	MYSTIQUE	V-6, 2.5 L	1997	-	1995
---------	----------	------------	------	---	------

FORD	CONTOUR	4 CIL, 2.0 L	1997	-	1995
------	---------	--------------	------	---	------

**CH-130221**



FORD	FIESTA	4 CIL, 1.6 L	2003	-	2010
------	--------	--------------	------	---	------

**CH-130121**



1 x 26.75

FORD	KA	4 CIL, 1.6 L	2005	-	2007
------	----	--------------	------	---	------

**CH-130232**



FORD	FIESTA	4 CIL, 1.6 L	2005	-	2008
------	--------	--------------	------	---	------

**CH-130241**



FORD IKON 4 CIL, 1.6 L 2003 - 2007

**CH-130261**



FORD ECOSPORT 4 CIL, 2.0 L 2007 - 2010

**CH-130272**



FORD ECOSPORT 4 CIL, 2.0 L 2007 - 2010

**CH-130281**



FORD COURIER 4 CIL, 1.6 L 2006 - 2007

**CH-130292**



FORD FIESTA 4 CIL, 1.6 L 2008 - 2010  
 FORD COURIER 4 CIL, 1.6 L 2006 - 2007

**CH-130521**



1 1/2 x 22

FORD THUNDERBIRD V-8, 5.0 L 1993 - 1993

**CH-131052**



1 1/2 x 29

MERCURY GHIA V-6, 3.0 L 1994 - 1993

**CH-131281**



1 1/2 x 26

MERCURY SABLE / TAURUS V-6, 3.8 L 1995 - 1993

**CH-131282**



2 x 7

FORD F SERIES PICKUP V-8, 5.8 L 1997 - 1995  
 FORD F-250 XLT V-8, 5.8 L 1997 - 1993  
 FORD F-250 XL V-8, 5.8 L 1997 - 1993

### CH-132382



1 1/2 x 21

MERCURY	COUGAR XR7	V-6, 3.8 L	1994	-	1993
---------	------------	------------	------	---	------

### CH-135381



1 1/2 x 36

FORD	F-150	V-6, 3.8 L	1994	-	1993
------	-------	------------	------	---	------

### CH-135382



1 3/4 x 35

FORD	F-150	V-6, 3.8 L	1994	-	1993
------	-------	------------	------	---	------

### CH-135581



1 1/2 x 37.5

FORD	F-250 XL	V-8, 5.0 L	1996	-	1993
FORD	F-350 XL	V-8, 5.8 L	1998	-	1993
FORD	F SERIES PICKUP	V-8, 5.8 L	1998	-	1995
FORD	F SERIES PICKUP	V-8, 5.0 L	1997	-	1995
FORD	F-250 XLT	V-8, 5.0 L	1996	-	1993
FORD	F-250 XLT	V-8, 5.8 L	1996	-	1993
FORD	F-250 XL	V-8, 5.8 L	1996	-	1993

### CH-136502



1 3/4 x 36

FORD	F-250 XLT	V-8, 5.0 L	1997	-	1993
FORD	F-250 XL	V-8, 5.0 L	1997	-	1993
FORD	F SERIES PICKUP	V-8, 5.8 L	1998	-	1995
FORD	F-350 XL	V-8, 5.8 L	1998	-	1993
FORD	F-350 XL	V-8, 5.0 L	1998	-	1993
FORD	F SERIES PICKUP	V-8, 5.0 L	1997	-	1995

### CH-136623



5/8 x 9

FORD	F SERIES PICKUP	V-8, 5.8 L	1998	-	1995
FORD	F SERIES PICKUP	V-8, 5.0 L	1997	-	1995
FORD	F-250 XL	V-8, 5.0 L	1997	-	1993
FORD	F-250 XLT	V-8, 5.0 L	1997	-	1993
FORD	EXPLORER	V-8, 5.0 L	1998	-	1998
FORD	F-350 XL	V-8, 5.8 L	1998	-	1993
FORD	F-350 XL	V-8, 5.0 L	1998	-	1993

### CH-136752



1 3/4 x 28

MERCURY	GHIA	V-6, 3.0 L	1994	-	1993
---------	------	------------	------	---	------

### CH-137581



1 1/2 x 23.75

## Aplicación por Producto

FORD F SERIES PICKUP V-8, 5.8 L 1998 - 1995

### CH-139401



FORD MONDEO 4 CIL, 2.0 L 2003 - 2006

### CH-139402



FORD MONDEO 4 CIL, 2.0 L 2003 - 2006

### CH-139412



FORD MONDEO V-6, 2.5 L 2003 - 2006

### CH-140111



1 1/4 x 26.75

CHEVROLET	ASTRA	4 CIL, 2.4 L	2006	-	2004
CHEVROLET	ASTRA	4 CIL, 1.8 L	2003	-	2000
CHEVROLET	ZAFIRA	4 CIL, 1.8 L	2003	-	2000
CHEVROLET	ZAFIRA	4 CIL, 2.4 L	2006	-	2004

### CH-140131



1 1/4 x 26.75

CHEVROLET ASTRA 4 CIL, 2.2 L 2000 - 2003

### CH-140141



1 1/4 x 26.75

CHEVROLET ZAFIRA 4 CIL, 1.8 L 2003 - 2000

CHEVROLET ASTRA 4 CIL, 1.8 L 2003 - 2000

### CH-140152



1 1/4 x 26.75

CHEVROLET ZAFIRA 4 CIL, 1.8 L 2003 - 2000

CHEVROLET ZAFIRA 4 CIL, 2.4 L 2006 - 2004

CHEVROLET ASTRA 4 CIL, 1.8 L 2003 - 2000

CHEVROLET ASTRA 4 CIL, 2.4 L 2006 - 2004

### CH-140162



CHEVROLET ASTRA 4 CIL, 2.2 L 2003 - 2000

CHEVROLET ZAFIRA 4 CIL, 2.2 L 2003 - 2000

### CH-140184



CHEVROLET	MONZA	4 CIL, 1.6 L	2004	-	1994
CHEVROLET	CHEVY C2	4 CIL, 1.6 L	2008	-	2004
CHEVROLET	CHEVY SWING	4 CIL, 1.6 L	2003	-	1994
CHEVROLET	CHEVY POP	4 CIL, 1.6 L	2003	-	1994
CHEVROLET	CHEVY	4 CIL, 1.6 L	2009	-	2010
CHEVROLET	CHEVY JOY	4 CIL, 1.6 L	2003	-	1994
CHEVROLET	CHEVY C2 SEDAN	4 CIL, 1.6 L	2008	-	2004
CHEVROLET	CHEVY PICK-UP	4 CIL, 1.6 L	2006	-	2002

### CH-140202



1 5/16 x 33.75

CHEVROLET	C-1500	6 CIL, 4.1 L	1996	-	1995
-----------	--------	--------------	------	---	------

### CH-140222



CHEVROLET	CORSA	4 CIL, 1.8 L	2008	-	2003
CHEVROLET	TORNADO	4 CIL, 1.8 L	2007	-	2003
CHEVROLET	TORNADO	4 CIL, 1.8 L	2008	-	2009
CHEVROLET	CORSA	4 CIL, 1.8 L	2009	-	2009

### CH-140187



15/32 x 33.5

CHEVROLET	CHEVY C2	4 CIL, 1.6 L	2008	-	2004
CHEVROLET	CHEVY	4 CIL, 1.6 L	2009	-	2010
CHEVROLET	CHEVY JOY	4 CIL, 1.6 L	2003	-	1994
CHEVROLET	CHEVY SWING	4 CIL, 1.6 L	2003	-	1994
CHEVROLET	CHEVY PICK-UP	4 CIL, 1.6 L	2006	-	2002
CHEVROLET	CHEVY POP	4 CIL, 1.6 L	2003	-	1994
CHEVROLET	CHEVY C2 SEDAN	4 CIL, 1.6 L	2008	-	2004
CHEVROLET	MONZA	4 CIL, 1.6 L	2004	-	1994

### CH-140231



CHEVROLET	LUV	4 CIL, 2.2 L	2003	-	2001
-----------	-----	--------------	------	---	------

### CH-140201



CHEVROLET	CORSA	4 CIL, 1.8 L	2008	-	2003
CHEVROLET	CORSA	4 CIL, 1.8 L	2009	-	2009
CHEVROLET	TORNADO	4 CIL, 1.8 L	2008	-	2009
CHEVROLET	TORNADO	4 CIL, 1.8 L	2007	-	2003

### CH-140242



CHEVROLET	LUV	4 CIL, 2.2 L	2003	-	2001
-----------	-----	--------------	------	---	------

### CH-140253



CHEVROLET	CHEVY C2	4 CIL, 1.6 L	2008	-	2004
CHEVROLET	MONZA	4 CIL, 1.6 L	2004	-	1994
CHEVROLET	CHEVY	4 CIL, 1.6 L	2009	-	2010
CHEVROLET	CHEVY C2 SEDAN	4 CIL, 1.6 L	2008	-	2004
CHEVROLET	CHEVY SWING	4 CIL, 1.6 L	2003	-	1994
CHEVROLET	CHEVY JOY	4 CIL, 1.6 L	2003	-	1994
CHEVROLET	CHEVY PICK-UP	4 CIL, 1.6 L	2006	-	2002
CHEVROLET	CHEVY POP	4 CIL, 1.6 L	2003	-	1994

### CH-140471



1 5/16 x 14.75

CHEVROLET	CHEVY SWING	4 CIL, 1.6 L	2003	-	1994
CHEVROLET	MONZA	4 CIL, 1.6 L	2004	-	1994
CHEVROLET	CHEVY	4 CIL, 1.6 L	2009	-	2010
CHEVROLET	CHEVY POP	4 CIL, 1.6 L	2003	-	1994
CHEVROLET	CHEVY C2	4 CIL, 1.6 L	2008	-	2004
CHEVROLET	CHEVY PICK-UP	4 CIL, 1.6 L	2006	-	2002
CHEVROLET	CHEVY C2 SEDAN	4 CIL, 1.6 L	2008	-	2004
CHEVROLET	CHEVY JOY	4 CIL, 1.6 L	2003	-	1994

### CH-140441



1 1/4 x 39

CHEVROLET	400SS	V-8, 5.7 L	2000	-	1999
CHEVROLET	CHEYENNE	V-8, 5.7 L	2000	-	1996
CHEVROLET	SUBURBAN	V-8, 5.7 L	1997	-	1996
CHEVROLET	C-2500	V-8, 5.7 L	2000	-	1998
CHEVROLET	C-1500	V-8, 5.7 L	2000	-	1999
CHEVROLET	C y K SERIES PICKUP	V-8, 5.7 L	2000	-	1998

### CH-140482



1 5/16 x 21

CHEVROLET	CHEVY	4 CIL, 1.6 L	2009	-	2010
CHEVROLET	CHEVY POP	4 CIL, 1.6 L	2003	-	1994
CHEVROLET	CHEVY C2 SEDAN	4 CIL, 1.6 L	2008	-	2004
CHEVROLET	CHEVY C2	4 CIL, 1.6 L	2008	-	2004
CHEVROLET	CHEVY PICK-UP	4 CIL, 1.6 L	2006	-	2002
CHEVROLET	MONZA	4 CIL, 1.6 L	2004	-	1994
CHEVROLET	CHEVY SWING	4 CIL, 1.6 L	2003	-	1994
CHEVROLET	CHEVY JOY	4 CIL, 1.6 L	2003	-	1994

### CH-140451



1 5/16 x 16.5

CHEVROLET	CHEVY PICK-UP	4 CIL, 1.6 L	2006	-	2002
CHEVROLET	CHEVY POP	4 CIL, 1.6 L	2003	-	1994
CHEVROLET	CHEVY C2	4 CIL, 1.6 L	2008	-	2004
CHEVROLET	CHEVY	4 CIL, 1.6 L	2009	-	2010
CHEVROLET	MONZA	4 CIL, 1.6 L	2004	-	1994
CHEVROLET	CHEVY SWING	4 CIL, 1.6 L	2003	-	1994
CHEVROLET	CHEVY C2 SEDAN	4 CIL, 1.6 L	2008	-	2004
CHEVROLET	CHEVY JOY	4 CIL, 1.6 L	2003	-	1994

### CH-140491



1 5/16 x 27.5

CHEVROLET	CAVALIER	4 CIL, 2.4 L	1999	-	1998
CHEVROLET	CAVALIER Z24	4 CIL, 2.4 L	2002	-	1995



### CH-140511



1 5/16 x 21.5

PONTIAC	SUNFIRE	4 CIL, 2.4 L	2000	-	1996
CHEVROLET	CAVALIER	4 CIL, 2.3 L	1995	-	1995
CHEVROLET	CAVALIER	4 CIL, 2.2 L	1997	-	1995

### CH-141073



17/32 x 8

CHEVROLET	C-35	V-8, 5.7 L	1993	-	1993
CHEVROLET	C y K SERIES PICKUP	V-8, 5.7 L	1993	-	1993

### CH-141002



1 1/2 x 28

CHEVROLET	P-30	V-8, 5.7 L	1995	-	1993
CHEVROLET	SUBURBAN	V-8, 5.7 L	1999	-	1999

### CH-141102



1 1/2 x 29

CHEVROLET	CENTURY	V-6, 3.1 L	1997	-	1993
CHEVROLET	CUTLASS	V-6, 3.1 L	1996	-	1993

### CH-141021



1 1/4 x 23

CHEVROLET	CUTLASS	V-6, 3.1 L	1996	-	1993
-----------	---------	------------	------	---	------

### CH-141281



1 1/4 x 32

CHEVROLET	C-35	V-8, 5.7 L	1993	-	1993
CHEVROLET	C y K SERIES PICKUP	V-8, 5.7 L	1993	-	1993

### CH-141022



1 1/2 x 23

CHEVROLET	C y K SERIES PICKUP	V-8, 5.7 L	1993	-	1993
CHEVROLET	C-35	V-8, 5.7 L	1993	-	1993

### CH-141571



1 1/4 x 38

CHEVROLET	C y K SERIES PICKUP	V-6, 4.3 L	1995	-	1995
CHEVROLET	C-3500	V-8, 5.7 L	1995	-	1994
CHEVROLET	C-2500	V-8, 5.7 L	1995	-	1993
CHEVROLET	C-1500	V-6, 4.3 L	1995	-	1995
CHEVROLET	C y K SERIES PICKUP	V-8, 5.7 L	1995	-	1993

### CH-145342



1 9/16 x 25.5

CHEVROLET	C-1500	6 CIL, 4.1 L	1996	-	1995
-----------	--------	--------------	------	---	------

### CH-147151



1 1/4 x 25.5

CHEVROLET	S-10	V-6, 3.1 L	1994	-	1993
CHEVROLET	S-10	V-6, 4.3 L	1994	-	1994

### CH-146571



1 1/4 x 36.25

CHEVROLET	HUNTER 2500	V-8, 5.7 L	1995	-	1993
CHEVROLET	C y K SERIES PICKUP	V-8, 5.7 L	1993	-	1993

### CH-147162



1 1/4 x 24

CHEVROLET	S-10	V-6, 4.3 L	1994	-	1994
CHEVROLET	S-10	V-6, 3.1 L	1994	-	1993

### CH-146572



1 1/2 x 34

CHEVROLET	400SS	V-8, 5.7 L	2000	-	1999
CHEVROLET	C-1500	V-8, 5.7 L	2000	-	1999
CHEVROLET	CHEYENNE	V-8, 5.7 L	2000	-	1993
CHEVROLET	HUNTER 2500	V-8, 5.7 L	1995	-	1993
CHEVROLET	SUBURBAN	V-8, 5.7 L	1998	-	1996
CHEVROLET	C y K SERIES PICKUP	V-8, 5.7 L	2000	-	1993

### CH-147211



1 1/4 x 21

CHEVROLET	CENTURY	V-6, 3.1 L	1997	-	1993
-----------	---------	------------	------	---	------

### CH-147282



1 5/16 x 6.5

CHEVROLET	CAVALIER Z24	V-6, 3.1 L	1994	-	1993
CHEVROLET	CAVALIER	V-6, 2.8 L	1994	-	1993

### CH-147011



1 1/4 x 24

CHEVROLET	CAVALIER	V-6, 2.8 L	1994	-	1993
CHEVROLET	CAVALIER Z24	V-6, 3.1 L	1994	-	1993

CH-148271



1 1/2 x 33.5

CHEVROLET P-30 V-8, 5.7 L 1995 - 1993

CH-148282



1 5/16 x 6.5

CHEVROLET CAVALIER V-6, 2.8 L 1993 - 1993

CH-148286



5/16 x 17.5

CHEVROLET CAVALIER V-6, 2.8 L 1994 - 1993

CH-148572

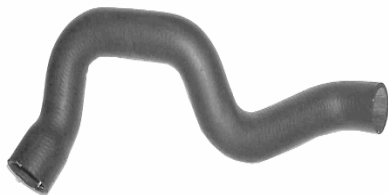

1 1/2 x 26.75

CHEVROLET P-30 V-8, 5.7 L 1993 - 1993

CH-149001



CHEVROLET ASTRA 4 CIL. 2.0 L 2004 - 2006

CH-149002



CHEVROLET ASTRA 4 CIL. 2.0 L 2004 - 2006

CH-149011



CHEVROLET ASTRA 4 CIL. 2.4 L 2004 - 2006

CH-149012



CHEVROLET ASTRA 4 CIL. 2.4 L 2004 - 2006

CH-149101



PONTIAC MATIZ G2 4 CIL. 1.0 L 2003 - 2009

CH-149102



## Aplicación por Producto

PONTIAC MATIZ G2 4 CIL. 1.0 L 2003 - 2009

**CH-180012**

**CH-149201**



1 1/16 x 21.5

NISSAN TSURU 4 CIL. 1.6 L 2005 - 2010

CHEVROLET MERIVA 4 CIL. 1.8 L 2005 - 2008

**CH-180021**

**CH-149202**



1 1/16 x 19.5

NISSAN TSURU 4 CIL. 1.6 L 1997 - 1993

CHEVROLET MERIVA 4 CIL. 1.8 L 2005 - 2008

**CH-180031**

**CH-149203**



1 1/3 x 20.5

NISSAN ESTAQUITAS 4 CIL. 2.4 L 2001 - 1998

NISSAN CHASIS 4 CIL. 2.4 L 2001 - 1998

NISSAN PICK-UP DOBLE CABINA 4 CIL. 2.4 L 2001 - 1998

NISSAN KING CAB 4 CIL. 2.4 L 2001 - 1998

CHEVROLET CHEVY C2 SEDAN 4 CIL. 1.6 L 2004 - 2008

CHEVROLET MONZA 4 CIL. 1.6 L 1994 - 2004

CHEVROLET CHEVY 4 CIL. 1.6 L 2009 - 2010

CHEVROLET CHEVY PICK-UP 4 CIL. 1.6 L 2002 - 2006

CHEVROLET CHEVY POP 4 CIL. 1.6 L 1994 - 2003

CHEVROLET CHEVY SWING 4 CIL. 1.6 L 1994 - 2003

CHEVROLET CHEVY C2 4 CIL. 1.6 L 2004 - 2008

CHEVROLET CHEVY JOY 4 CIL. 1.6 L 1994 - 1998

**CH-180032**

**CH-180011**



1 1/16 x 23.5

NISSAN SENTRA 4 CIL. 1.6 L 1997 - 1995

1 1/16 x 15.5

NISSAN SENTRA 4 CIL. 1.6 L 1997 - 1995

NISSAN TSURU 4 CIL. 1.6 L 2005 - 2010

### CH-180041



1 5/16 x 21

NISSAN	PICK-UP	4 CIL, 2.4 L	1994	-	1993
--------	---------	--------------	------	---	------

### CH-180071



1 5/8 x 12.5

NISSAN	SENTRA	4 CIL, 1.6 L	1999	-	1998
--------	--------	--------------	------	---	------

### CH-180042



1 11/32 x 29.5

NISSAN	PICK-UP DOBLE CABINA	4 CIL, 2.4 L	2001	-	1998
NISSAN	KING CAB	4 CIL, 2.4 L	2001	-	1998
NISSAN	CHASIS	4 CIL, 2.4 L	2001	-	1998
NISSAN	ESTAQUITAS	4 CIL, 2.4 L	2001	-	1998

### CH-180082



1 1/16 x 24.5

NISSAN	SENTRA	4 CIL, 1.6 L	1999	-	1998
--------	--------	--------------	------	---	------

### CH-180051



1 11/32 x 14

NISSAN	SENTRA	4 CIL, 1.8 L	2003	-	2000
NISSAN	SENTRA	4 CIL, 1.6 L	1999	-	1998
NISSAN	SENTRA	4 CIL, 2.0 L	2002	-	1998

### CH-180141



RE-USAR LA MANGA Y EL COMPONENTE METALICO I

NISSAN	URVAN	4 CIL, 2.4 L	2005	-	2005
NISSAN	URVAN	4 CIL, 2.4 L	2004	-	2008

### CH-180152



NISSAN	URVAN	4 CIL, 2.4 L	2005	-	2008
--------	-------	--------------	------	---	------

### CH-180062



NISSAN	SENTRA	4 CIL, 1.6 L	1999	-	1998
NISSAN	SENTRA	4 CIL, 2.0 L	2002	-	1998
NISSAN	SENTRA	4 CIL, 1.8 L	2003	-	2000

### CH-180162



1 1/16 x 17.5

## Aplicación por Producto

NISSAN	TSURU	4 CIL, 1.6 L	1997 - 1993
--------	-------	--------------	-------------

### CH-180164



5/8 x 43

NISSAN	TSURU	4 CIL, 1.6 L	1996 - 1993
--------	-------	--------------	-------------

### CH-180182



RENAULT	KANGOO	4 CIL, 1.6 L	2008 - 2010
RENAULT	CLIO	4 CIL, 1.6 L	2008 - 2009
RENAULT	KANGOO EXPRESS	4 CIL, 1.6 L	2008 - 2009
NISSAN	PLATINA	4 CIL, 1.6 L	2008 - 2010

### CH-180191



RENAULT	CLIO	4 CIL, 1.6 L	2008 - 2009
RENAULT	KANGOO EXPRESS	4 CIL, 1.6 L	2008 - 2009
NISSAN	PLATINA	4 CIL, 1.6 L	2008 - 2010
RENAULT	KANGOO	4 CIL, 1.6 L	2008 - 2010

### CH-180202



NISSAN	PICK-UP	4 CIL, 2.4 L	2007 - 1994
NISSAN	ESTAQUITAS	4 CIL, 2.4 L	2001 - 1995
NISSAN	ESTAQUITAS	4 CIL, 2.4 L	2007 - 2002

### CH-181001



1 x 22

NISSAN	ICHI VAN	4 CIL, 1.8 L	1994 - 1993
NISSAN	ESTAQUITAS	4 CIL, 1.8 L	1994 - 1993

### CH-181194



5/8 x 18

NISSAN	ICHI VAN	4 CIL, 1.8 L	1994 - 1993
--------	----------	--------------	-------------

### CH-181214



5/8 x 40

NISSAN	ICHI VAN	4 CIL, 1.8 L	1994 - 1994
--------	----------	--------------	-------------

### CH-181222



1 3/16 x 25

NISSAN	ICHI VAN	4 CIL, 1.8 L	1994 - 1993
NISSAN	ESTAQUITAS	4 CIL, 1.8 L	1994 - 1993



## Aplicación por Producto

**CH-181263**



1 1/32 x 14

NISSAN	TSURU	4 CIL, 1.6 L	2001	-	1994
NISSAN	TSURU	4 CIL, 2.0 L	1996	-	1999

**CH-181414**



5/8 x 18

NISSAN	ICHI VAN	4 CIL, 1.8 L	1993	-	1993
--------	----------	--------------	------	---	------

**CH-186241**



1 11/32 x 19

NISSAN	ICHI VAN	4 CIL, 2.4 L	1994	-	1993
--------	----------	--------------	------	---	------

**CH-186242**



1 11/32 x 26

NISSAN	ICHI VAN	4 CIL, 2.4 L	1994	-	1993
--------	----------	--------------	------	---	------

**CH-188163**



1 1/32 x 14.5

NISSAN	TSURU	4 CIL, 1.6 L	1997	-	1993
--------	-------	--------------	------	---	------

**CH-189164**



5/8 x 13

NISSAN	TSURU	4 CIL, 1.6 L	1997	-	1993
--------	-------	--------------	------	---	------

**CH-189201**



1 11/32 x 13

NISSAN	TSURU	4 CIL, 2.0 L	1996	-	1999
--------	-------	--------------	------	---	------

**CH-189202**



1 11/32 x 22.5

NISSAN	TSURU	4 CIL, 2.0 L	1996	-	1999
--------	-------	--------------	------	---	------

**CH-220034**



3/4 x 17.5

VOLKSWAGEN	DERBY	4 CIL, 1.8 L	2001	-	1999
VOLKSWAGEN	JETTA	4 CIL, 1.8 L	2000	-	1993
VOLKSWAGEN	GOLF	4 CIL, 1.8 L	2000	-	1993

### CH-220054



3/4 x 22.404

VOLKSWAGEN	DERBY	4 CIL, 1.8 L	2001	-	1999
VOLKSWAGEN	GOLF	4 CIL, 1.8 L	2000	-	1993
VOLKSWAGEN	JETTA	4 CIL, 1.8 L	2000	-	1993

### CH-220333



3/4 x 9

VOLKSWAGEN	GOLF	4 CIL, 1.8 L	2000	-	1993
VOLKSWAGEN	JETTA	4 CIL, 1.8 L	2000	-	1993

### CH-220064



3/4 x 21

VOLKSWAGEN	JETTA	4 CIL, 1.8 L	2000	-	1993
VOLKSWAGEN	GOLF	4 CIL, 1.8 L	2000	-	1993
VOLKSWAGEN	DERBY	4 CIL, 1.8 L	2001	-	1999

### CH-220371



1 1/4 x 15

VOLKSWAGEN	POINTER	4 CIL, 1.8 L	2001	-	1998
VOLKSWAGEN	POINTER PICK-UP	4 CIL, 1.8 L	2001	-	1998
VOLKSWAGEN	POINTER STATION WAGON	4 CIL, 1.8 L	2001	-	1998

### CH-220073



1 1/32 x 22

VOLKSWAGEN	JETTA	4 CIL, 1.8 L	2000	-	1993
VOLKSWAGEN	GOLF	4 CIL, 1.8 L	2000	-	1993

### CH-220423



1 x 18

VOLKSWAGEN	POINTER PICK-UP	4 CIL, 1.8 L	2001	-	1998
VOLKSWAGEN	POINTER	4 CIL, 1.8 L	2001	-	1998
VOLKSWAGEN	POINTER STATION WAGON	4 CIL, 1.8 L	2001	-	1998

### CH-220083



1/2 x 9

VOLKSWAGEN	JETTA	4 CIL, 1.8 L	2000	-	1993
VOLKSWAGEN	GOLF	4 CIL, 1.8 L	2000	-	1993

### CH-220523



3/4 x 17.75

VOLKSWAGEN	POINTER PICK-UP	4 CIL, 1.8 L	2001	-	1998
VOLKSWAGEN	POINTER	4 CIL, 1.8 L	2001	-	1998
VOLKSWAGEN	POINTER STATION WAGON	4 CIL, 1.8 L	2001	-	1998

### CH-220532



1 1/4 x 21

VOLKSWAGEN	POINTER	4 CIL, 1.8 L	2001	-	1998
VOLKSWAGEN	POINTER PICK-UP	4 CIL, 1.8 L	2001	-	1998
VOLKSWAGEN	POINTER STATION WAGON	4 CIL, 1.8 L	2001	-	1998

### CH-220702



1 3/16 x 14.5

VOLKSWAGEN	DERBY	4 CIL, 1.8 L	2008	-	1999
------------	-------	--------------	------	---	------

### CH-220551



1 x 11

VOLKSWAGEN	JETTA	4 CIL, 2.0 L	1997	-	1995
VOLKSWAGEN	GOLF	4 CIL, 2.0 L	1997	-	1995

### CH-220711



1 3/16 x 21.5

VOLKSWAGEN	DERBY	4 CIL, 1.8 L	2008	-	1999
------------	-------	--------------	------	---	------

### CH-220593



1 x 19

VOLKSWAGEN	DERBY	4 CIL, 1.8 L	2001	-	1999
VOLKSWAGEN	GOLF	4 CIL, 1.8 L	2000	-	1993
VOLKSWAGEN	PANEL	4 CIL, 1.8 L	2001	-	1993
VOLKSWAGEN	JETTA	4 CIL, 1.8 L	2000	-	1993
VOLKSWAGEN	COMBI	4 CIL, 1.8 L	2001	-	1993
VOLKSWAGEN	CARAVELLE	4 CIL, 1.8 L	1996	-	1993

### CH-220721



1 1/4 x 16.5

VOLKSWAGEN	JETTA	4 CIL, 2.0 L	1998	-	1998
VOLKSWAGEN	GOLF	4 CIL, 2.0 L	2001	-	1998

### CH-220731



1 1/4 x 12

VOLKSWAGEN	JETTA	4 CIL, 2.0 L	2001	-	1998
VOLKSWAGEN	GOLF	4 CIL, 2.0 L	2001	-	1998

### CH-220663



3/4 X 17

VOLKSWAGEN	GOLF	4 CIL, 1.8 L	2000	-	1993
VOLKSWAGEN	JETTA	4 CIL, 1.8 L	2000	-	1993

### CH-220741



1 1/4 x 15.5

VOLKSWAGEN	EUROVAN	5 CIL, 2.5 L	2002	-	2003
------------	---------	--------------	------	---	------

### CH-220782



SEAT	CORDOBA	4 CIL, 1.6 L	2007	-	2008
SEAT	IBIZA	4 CIL, 1.6 L	2007	-	2009
VOLKSWAGEN	POLO	4 CIL, 1.6 L	2007	-	2003

### CH-220751



1 3/16 x 29.5

VOLKSWAGEN	EUROVAN	5 CIL, 2.5 L	2002	-	2003
------------	---------	--------------	------	---	------

### CH-220811



VOLKSWAGEN	DERBY	4 CIL, 1.8 L	2004	-	2003
------------	-------	--------------	------	---	------

### CH-220762



1 3/16 x 26

1 A 2

VOLKSWAGEN	EUROVAN	5 CIL, 2.5 L	2006	-	2006
VOLKSWAGEN	EUROVAN	5 CIL, 2.5 L	2002	-	2003
VOLKSWAGEN	EUROVAN	5 CIL, 2.5 L	2005	-	2005

### CH-220832



VOLKSWAGEN	DERBY	4 CIL, 2.0 L	2004	-	2003
VOLKSWAGEN	DERBY	4 CIL, 1.8 L	2008	-	2003

### CH-220772



1 1/4 x 32.5

VOLKSWAGEN	EUROVAN	5 CIL, 2.5 L	2002	-	2001
VOLKSWAGEN	EUROVAN	5 CIL, 2.5 L	2006	-	2006
VOLKSWAGEN	EUROVAN	5 CIL, 2.5 L	2005	-	2005

### CH-220841



VOLKSWAGEN	POINTER	4 CIL, 1.8 L	2008	-	2002
VOLKSWAGEN	POINTER PICK-UP	4 CIL, 1.8 L	2005	-	2002

### CH-220852



VOLKSWAGEN	POINTER PICK-UP	4 CIL, 1.8 L	2005	-	2002
VOLKSWAGEN	POINTER	4 CIL, 1.8 L	2008	-	2002

### CH-227182



VOLKSWAGEN	CARAVELLE	4 CIL, 1.8 L	1996	-	1993
VOLKSWAGEN	COMBI	4 CIL, 1.8 L	2001	-	1993
VOLKSWAGEN	PANEL	4 CIL, 1.8 L	2001	-	1993

### CH-220871



SEAT	IBIZA	4 CIL, 1.6 L	2007	-	2009
SEAT	CORDOBA	4 CIL, 1.6 L	2007	-	2008
VOLKSWAGEN	POLO	4 CIL, 1.6 L	2007	-	2003

### CH-228181



1 1/16 x 24.375

VOLKSWAGEN	JETTA	4 CIL, 1.8 L	2000	-	1993
VOLKSWAGEN	GOLF	4 CIL, 1.8 L	2000	-	1993

### CH-221003



3/4 x 7.25

VOLKSWAGEN	SEDAN	4 CIL, 1.6 L	2001	-	1993
------------	-------	--------------	------	---	------

### CH-228182



1 1/16 x 23.375

VOLKSWAGEN	JETTA	4 CIL, 1.8 L	2000	-	1993
VOLKSWAGEN	GOLF	4 CIL, 2.0 L	2001	-	1995
VOLKSWAGEN	JETTA	4 CIL, 2.0 L	1997	-	1995
VOLKSWAGEN	GOLF	4 CIL, 1.8 L	2000	-	1993
VOLKSWAGEN	CABRIO	4 CIL, 2.0 L	2000	-	1999

### CH-227181



VOLKSWAGEN	PANEL	4 CIL, 1.8 L	2001	-	1993
VOLKSWAGEN	CARAVELLE	4 CIL, 1.8 L	1996	-	1993
VOLKSWAGEN	COMBI	4 CIL, 1.8 L	2001	-	1993

### CH-229181



1 x 22.25

VOLKSWAGEN	JETTA	4 CIL, 1.8 L	1994	-	1993
VOLKSWAGEN	GOLF	4 CIL, 1.8 L	2000	-	1993

### CH-229182

NISSAN FRONTIER 4 CIL, 2.4 L 2002 - 2002



1 x 12

VOLKSWAGEN	JETTA	4 CIL, 1.8 L	1994	-	1993
VOLKSWAGEN	GOLF	4 CIL, 1.8 L	2000	-	1993

### CH-230001



PEUGEOT	PARTNER	4 CIL, 1.6 L	2004	-	2008
PEUGEOT	GRAND RAID	4 CIL, 1.6 L	2004	-	2008
PEUGEOT	206	4 CIL, 1.4 L	1998	-	2008
PEUGEOT	206	4 CIL, 1.6 L	1998	-	2008

### CH-230002



PEUGEOT	206	4 CIL, 1.4 L	1998	-	2008
PEUGEOT	GRAND RAID	4 CIL, 1.6 L	2004	-	2008
PEUGEOT	PARTNER	4 CIL, 1.6 L	2004	-	2008
PEUGEOT	206	4 CIL, 1.6 L	1998	-	2008

### CHARTER 1 1/4"



(3 1/2")

LAND ROVER	RANGE ROVER	V-8, 4.0 L	2000	-	1999
NISSAN	XTERRA	4 CIL, 2.4 L	2004	-	2001
LAND ROVER	RANGE ROVER	V-8, 4.6 L	2002	-	1999
NISSAN	XTERRA	4 CIL, 2.4 L	2002	-	2002



## Aplicación por Producto

### Tapones de Aceite

**31066**



JEEP	CHEROKEE	4 CIL, 2.5 L	1997 - 1996
JEEP	CHEROKEE	6 CIL, 4.0 L	1998 - 1998

**31081**

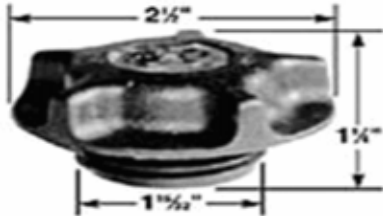

TOYOTA	RAV 4	4 CIL, 2.0 L	2003 - 2003
TOYOTA	LAND CRUISER	V-8, 4.7 L	2007 - 2003
TOYOTA	4 RUNNER	V-8, 4.7 L	2006 - 2003
TOYOTA	HIGHLANDER	V-6, 3.5 L	2008 - 2008
TOYOTA	TUNDRA	V-8, 4.7 L	2008 - 2007
TOYOTA	MATRIX	4 CIL, 1.8 L	2004 - 2003
TOYOTA	COROLLA	4 CIL, 1.8 L	2004 - 2002
TOYOTA	4 RUNNER	V-6, 3.4 L	2002 - 2002
TOYOTA	RAV 4	4 CIL, 2.4 L	2004 - 2003
TOYOTA	CAMRY	4 CIL, 2.2 L	2001 - 2001
TOYOTA	SEQUOIA	V-8, 4.7 L	2008 - 2007
TOYOTA	SIENNA	V-6, 3.5 L	2009 - 2010

**31085**

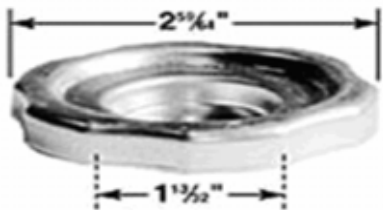

MITSUBISHI	ECLIPSE	V-6, 3.0 L	2005 - 2004
MITSUBISHI	LANCER	4 CIL, 2.0 L	2006 - 2008
MITSUBISHI	MONTERO	V-6, 3.8 L	2007 - 2004
MITSUBISHI	ECLIPSE	V-6, 3.8 L	2007 - 2008
CHRYSLER	CIRRUS	4 CIL, 2.4 L	2005 - 2005
MITSUBISHI	ENDEAVOR	V-6, 3.8 L	2007 - 2004
CHRYSLER	GRAND VOYAGER	V-6, 3.3 L	2000 - 2000

MITSUBISHI	GALANT	V-6, 3.8 L	2007 - 2004
DODGE	STRATUS	4 CIL, 2.4 L	2004 - 2001
DODGE	STRATUS	V-6, 3.0 L	2002 - 2001
CHRYSLER	SEBRING	4 CIL, 2.4 L	1996 - 1996
MITSUBISHI	OUTLANDER	4 CIL, 2.4 L	2006 - 2004
MITSUBISHI	MONTERO SPORT	V-6, 3.5 L	2004 - 2004
CHRYSLER	SEBRING	V-6, 3.0 L	2006 - 2004
CHRYSLER	SEBRING	V-6, 2.5 L	1999 - 1997
MITSUBISHI	GALANT	4 CIL, 2.4 L	2007 - 2004
MITSUBISHI	LANCER	4 CIL, 2.4 L	2006 - 2004

**31099**

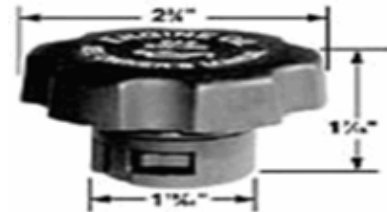

CHEVROLET	EXPRESS VAN	V-6, 4.3 L	2000 - 1998
CHEVROLET	C y K SERIES PICKUP	V-8, 7.4 L	2000 - 1999
CHEVROLET	C y K SERIES PICKUP	V-8, 8.1 L	2002 - 2001
CHEVROLET	EXPRESS	V-6, 4.3 L	2002 - 2001
CHEVROLET	EXPRESS	V-8, 5.0 L	2002 - 2000
CHEVROLET	EXPRESS	V-8, 5.7 L	2002 - 1999
CHEVROLET	EXPRESS	V-8, 7.4 L	1999 - 1999
CHEVROLET	EXPRESS	V-8, 8.1 L	2002 - 2001
CHEVROLET	EXPRESS CARGO VAN	V-8, 5.7 L	2000 - 1998
CHEVROLET	EXPRESS VAN PASAJEROS	V-6, 4.3 L	2000 - 1998
CHEVROLET	SUBURBAN	V-8, 8.1 L	2002 - 2002
CHEVROLET	SILVERADO	V-8, 8.1 L	2001 - 2001

**31100**

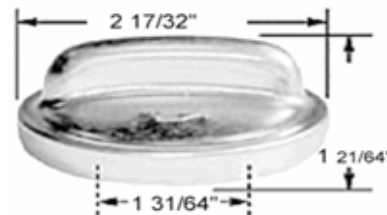

VOLKSWAGEN	BEETLE	4 CIL, 2.0 L	2008 - 1998
BMW	323IS	V-6, 2.5 L	1999 - 1999
VOLKSWAGEN	BEETLE	5 CIL, 2.5 L	2008 - 2006
BMW	318TI	4 CIL, 1.9 L	1999 - 1999
AUDI	TT	4 CIL, 1.8 L	2006 - 2000
VOLKSWAGEN	BORA	5 CIL, 2.5 L	2008 - 2005
MERCEDES BE	SLK320	V-6, 3.2 L	2000 - 2000
MERCEDES BE	SLK230	4 CIL, 2.3 L	2000 - 1998
AUDI	S4 QUATTRO	V-6, 2.7 L	2002 - 2000
VOLKSWAGEN	BORA SPORTWAGEN	5 CIL, 2.5 L	2008 - 2009

## Aplicación por Producto

MERCEDES BE	ML320	V-6, 3.2 L	2000	-	1999
AUDI	ALLROAD QUATTRO	V-6, 2.7 L	2006	-	2002
MERCEDES BE	E320	V-6, 3.2 L	2000	-	1997
MERCEDES BE	C280	V-6, 2.8 L	2000	-	1997
AUDI	A8	V-8, 4.2 L	2001	-	1999
MERCEDES BE	C230	4 CIL. 2.3 L	2000	-	1997
VOLKSWAGEN	BORA	5 CIL. 2.5 L	2009	-	2009
BMW	740IL	V-8, 4.4 L	2001	-	1999
BMW	Z4	V-6, 3.0 L	2004	-	2004
BMW	Z4	V-6, 2.5 L	2006	-	2004
BMW	Z4	6 CIL. 3.0 L	2003	-	2003
BMW	Z4	6 CIL. 2.5 L	2003	-	2003
BMW	Z3	V-6, 3.0 L	2001	-	1999
BMW	Z3	V-6, 2.8 L	2000	-	1999
BMW	Z3	V-6, 2.5 L	2001	-	2000
BMW	X5	V-8, 4.4 L	2004	-	2000
BMW	X5	V-6, 3.0 L	2004	-	2001
BMW	M5	V-8, 5.0 L	2003	-	2003
BMW	M3	V-6, 3.2 L	2006	-	1999
BMW	760LI	V-12, 6.0 L	2004	-	2004
BMW	330CI	V-6, 3.0 L	2006	-	2004
BMW	745I	V-8, 4.4 L	2004	-	2003
VOLKSWAGEN	BEETLE	4 CIL. 1.8 L	2005	-	1999
BMW	740I	V-8, 4.4 L	2001	-	1998
BMW	545I	V-8, 4.4 L	2005	-	2004
BMW	540I	V-8, 4.4 L	2001	-	2001
BMW	528I	V-6, 2.8 L	1999	-	1998
BMW	525I	6 CIL. 2.5 L	2005	-	2002
BMW	530I	6 CIL. 3.0 L	2002	-	2002
BMW	330XI	6 CIL. 3.0 L	2001	-	2001
AUDI	A8	V-8, 3.7 L	1999	-	1999
BMW	330CI	6 CIL. 3.0 L	2003	-	2001
BMW	328IS	V-6, 2.8 L	1999	-	1998
BMW	328I	V-6, 2.8 L	2000	-	1998
BMW	325I	V-6, 2.5 L	2005	-	2001
BMW	325CI	V-6, 2.5 L	2006	-	2001
BMW	750IL	V-12, 5.4 L	2001	-	1998
VOLKSWAGEN	EUROVAN	5 CIL. 2.5 L	2002	-	2003
AUDI	A3	4 CIL. 2.0 L	2006	-	2008
AUDI	A3	V-6, 3.2 L	2007	-	2008
VOLKSWAGEN	TOUAREG	V-6, 3.6 L	2007	-	2008
VOLKSWAGEN	TOUAREG	V-6, 3.2 L	2006	-	2005
VOLKSWAGEN	PASSAT	V-6, 3.6 L	2008	-	2006
AUDI	A4	4 CIL. 1.8 L	2004	-	1998
VOLKSWAGEN	PASSAT	4 CIL. 1.8 L	2005	-	1999
AUDI	A4	V-6, 2.8 L	2000	-	1998
VOLKSWAGEN	JETTA	4 CIL. 2.0 L	2008	-	2010
VOLKSWAGEN	JETTA	4 CIL. 1.9 L DIESE2005	2005	-	2000
AUDI	A4	V-6, 3.0 L	2004	-	2002
VOLKSWAGEN	GTI	4 CIL. 2.0 L	2000	-	1999
VOLKSWAGEN	GTI	V-6, 2.8 L	2001	-	1999
AUDI	A6	V-6, 2.7 L	2000	-	2000

AUDI	A6	V-6, 2.8 L	2001	-	1998
------	----	------------	------	---	------

### 31103



CHEVROLET	SUBURBAN	V-8, 6.0 L	2004	-	2003
CADILLAC	ESCALADE	V-8, 6.2 L	2007	-	2007
CADILLAC	SRX	V-6, 3.6 L	2006	-	2004
CHEVROLET	SUBURBAN	V-8, 7.4 L	2004	-	2002
CADILLAC	SRX	V-8, 4.6 L	2004	-	2004
CHEVROLET	EXPRESS	V-8, 6.5 L	2000	-	2000
CHEVROLET	EXPRESS	V-8, 6.0 L	2007	-	2010
CHEVROLET	EXPRESS	V-8, 5.3 L	2007	-	2010
CHEVROLET	SUBURBAN	V-8, 8.1 L	2004	-	2002
CHEVROLET	EXPRESS	V-6, 4.3 L	2003	-	2003
CHEVROLET	TAHOE	V-8, 4.8 L	2007	-	2006
CHEVROLET	SUBURBAN	V-8, 5.7 L	2004	-	2002
CHEVROLET	EQUINOX	V-6, 3.4 L	2007	-	2005
CADILLAC	CTS	V-6, 3.2 L	2004	-	2003
CHEVROLET	COLORADO	5 CIL. 3.7 L	2007	-	2010
CHEVROLET	COLORADO	5 CIL. 3.5 L	2006	-	2004
CHEVROLET	COLORADO	4 CIL. 2.9 L	2007	-	2010
CHEVROLET	COLORADO	4 CIL. 2.8 L	2006	-	2005
CHEVROLET	CAPTIVA	V-6, 3.6 L	2008	-	2010
CHEVROLET	TRAILBLAZER	6 CIL. 4.2 L	2007	-	2002
CHEVROLET	CAPTIVA	4 CIL. 2.4 L	2009	-	2010
CHEVROLET	CAPTIVA	4 CIL. 2.4 L	2008	-	2008
CHEVROLET	TRAILBLAZER	V-8, 5.3 L	2003	-	2003
CHEVROLET	TRAVERSE	V-6, 3.6 L	2010	-	2011
CHEVROLET	TAHOE	V-8, 5.3 L	2007	-	2010
CHEVROLET	S-10	4 CIL. 2.2 L	2002	-	1999
CHEVROLET	SILVERADO	V-8, 5.3 L	2001	-	2010
BMW	X5	V-6, 3.0 L	2007	-	2009
GMC	CANYON	5 CIL. 3.7 L	2008	-	2010
GMC	ACADIA	V-6, 3.6 L	2009	-	2010
GMC	SIERRA	V-8, 5.3 L	2009	-	2010
CADILLAC	DEVILLE	V-8, 4.6 L	2005	-	1997
GMC	SIERRA	V-8, 6.2 L	2009	-	2010
CHEVROLET	SILVERADO	V-8, 6.0 L	2007	-	2002
CHEVROLET	LUMINA	V-6, 3.1 L	1998	-	1996
CHEVROLET	SILVERADO	V-8, 6.6 L	2001	-	2001
CADILLAC	CTS	V-6, 3.6 L	2006	-	2005
DODGE	DURANGO	V-8, 5.2 L	1999	-	1999
CHEVROLET	EXPRESS CARGO VAN	V-6, 4.3 L	2007	-	2010
GMC	YUKON	V-8, 6.2 L	2009	-	2010
CADILLAC	ESCALADE	V-8 6.2 L	2008	-	2010

## Aplicación por Producto

CADILLAC	ESCALADE	V-8, 5.3 L	2004 - 2002
OLDSMOBILE	EIGHTY EIGHT	V-6, 3.8 L	1999 - 1998
CHEVROLET	SILVERADO	V-8, 4.8 L	2007 - 2010
CHEVROLET	UPLANDER	V-6, 3.5 L	2007 - 2005
CADILLAC	ESCALADE	V-8, 5.7 L	2000 - 1999
CADILLAC	ESCALADE	V-8, 6.0 L	2006 - 2002
CHEVROLET	SONORA	V-8, 5.3 L	2003 - 2003
BUICK	ENCLAVE	V-6, 3.6 L	2010 - 2010
CHEVROLET	SUBURBAN	V-8, 5.3 L	2007 - 2010
CADILLAC	SEVILLE	V-8, 4.6 L	2004 - 1998
PONTIAC	MONTANA	V-6, 3.5 L	2006 - 2006
CHEVROLET	AVALANCHE	V-8, 5.3 L	2007 - 2010
CHEVROLET	CAVALIER	4 CIL, 2.2 L	2005 - 2002
CHEVROLET	MALIBU	V-6, 3.1 L	2003 - 1999
PONTIAC	G6	V-6, 3.9 L	2006 - 2006
PONTIAC	GRAND AM	4 CIL, 2.2 L	2003 - 2002
CHEVROLET	MALIBU	4 CIL, 2.2 L	2007 - 2004
PONTIAC	GRAND AM	4 CIL, 2.4 L	2001 - 1998
CHRYSLER	PACIFICA	V-6, 3.5 L	2006 - 2004
CHEVROLET	IMPALA	V-6, 3.8 L	2005 - 2000
PONTIAC	TORRENT	V-6, 3.4 L	2008 - 2006
PONTIAC	GRAND AM	V-6, 3.1 L	1998 - 1997
CHEVROLET	MALIBU	V-6, 3.5 L	2007 - 2003
DODGE	INTREPID	V-6, 2.7 L	2003 - 1998
CHRYSLER	PT CRUISER	4 CIL, 2.4 L	2007 - 2005
CHEVROLET	IMPALA	V-6, 3.4 L	2005 - 2000
PONTIAC	GRAND PRIX	V-6, 3.1 L	2002 - 1997
CHEVROLET	HHR	4 CIL, 2.4 L	2008 - 2006
PONTIAC	AZTEK	V-6, 3.4 L	2005 - 2001
DODGE	STRATUS	V-6, 2.7 L	2002 - 2001
CHEVROLET	CORVETTE	V-8, 6.0 L	2007 - 2005
PONTIAC	GRAND PRIX	V-6, 3.8 L	2005 - 1997
CHEVROLET	CORVETTE	V-8, 5.7 L	2004 - 1997
PONTIAC	SOLSTICE	4 CIL, 2.4 L	2008 - 2006
DODGE	JOURNEY	V-6, 3.5 L	2009 - 2010
PONTIAC	SUNFIRE	4 CIL, 2.2 L	2004 - 2003
DODGE	DURANGO	V-8, 5.9 L	2002 - 1998
PONTIAC	GRAND AM	V-6, 3.4 L	2005 - 1999
CHRYSLER	CONCORDE	V-6, 2.7 L	2000 - 1998
PONTIAC	G4	4 CIL, 2.4 L	2006 - 2006
CHEVROLET	CAMARO Z28	V-6, 3.8 L	2002 - 1996
PONTIAC	G4	4 CIL, 2.2 L	2006 - 2006
CHEVROLET	VENTURE	V-6, 3.4 L	2005 - 1998
PONTIAC	FIREBIRD TRANS AM	V-8, 5.7 L	2002 - 1998
OLDSMOBILE	SILHOUETTE	V-6, 3.4 L	1996 - 1996
PONTIAC	G6	V-6, 3.5 L	2008 - 2006
HUMMER	H3	5 CIL, 3.7 L	2008 - 2010
PONTIAC	G5	4 CIL, 2.2 L	2008 - 2007
HUMMER	H2	V-8, 6.2 L	2008 - 2010
CHEVROLET	MONTE CARLO	V-6, 3.8 L	2005 - 2004
HUMMER	H3	5 CIL, 3.5 L	2007 - 2006
GMC	YUKON	V-8, 5.3 L	2008 - 2007

HUMMER	H2	V-8, 6.0 L	2007 - 2006
CHEVROLET	MONTE CARLO	V-6, 3.4 L	2005 - 2004
PONTIAC	G5	4 CIL, 2.4 L	2008 - 2007
CHEVROLET	MALIBU	V-6, 3.6 L	2008 - 2010
SAAB	9-3	V-6, 2.8 L	2007 - 2006
CHEVROLET	SILVERADO	V-6, 4.3 L	2007 - 2010
CHEVROLET	CAMARO Z28	V-8, 5.7 L	2002 - 2000
CHEVROLET	UPLANDER	V-6, 3.9 L	2006 - 2009

### 31109

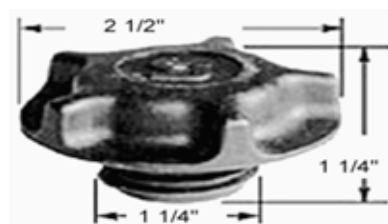

FORD	SUPER DUTY PICKUP	V-8, 6.0 L DIESEL	2003 - 2003
SUZUKI	AERIO	4 CIL, 2.3 L	2006 - 2005
FORD	SUPER DUTY PICKUP	V-10, 6.8 L	2000 - 2003
FORD	SUPER DUTY VAN	V-8, 5.4 L	2001 - 2000
FORD	WINDSTAR	V-6, 3.0 L	1998 - 1998
FORD	SUPER DUTY PICKUP	V-8, 7.3 L	2000 - 2000
FORD	SUPER DUTY VAN	V-8, 4.6 L	2003 - 2003
FORD	SUPER DUTY VAN	V-8, 7.3 L	2001 - 2000
FORD	SUPER DUTY PICKUP	V-8, 5.4 L	2003 - 2000
FORD	SUPER DUTY VAN	V-10, 6.8 L	2002 - 2000
FORD	SUPER DUTY VAN	V-6, 4.2 L	2001 - 2003
CHEVROLET	TRACKER	4 CIL, 1.6 L	2000 - 1997
FORD	EXPEDITION	V-8, 5.4 L	2004 - 2000
FORD	EXPLORER	V-8, 4.6 L	2002 - 2002
HYUNDAI	ATTITUDE	4 CIL, 1.6 L	2008 - 2010
FORD	EXPLORER	V-8, 5.0 L	2001 - 1998
HYUNDAI	ATTITUDE	4 CIL, 1.4 L	2008 - 2010
FORD	F-350 SUPER DUTY	V-8, 5.4 L	2006 - 1999
FORD	F SERIES PICKUP	V-8, 4.6 L	2001 - 2000
FORD	EXCURSION	V-10, 6.8 L	2005 - 2001
FORD	F SERIES PICKUP	V-8, 5.4 L	2002 - 2000
FORD	F-150	V-6, 4.2 L	2006 - 1999
HONDA	ODYSSEY	V-6, 3.5 L	2003 - 2003
CHEVROLET	TRACKER	V-6, 2.5 L	2004 - 2002
CHEVROLET	TRACKER	4 CIL, 2.0 L	2003 - 1999
FORD	F-250	V-8, 4.6 L	2006 - 1998
FORD	F SERIES PICKUP	V-6, 4.2 L	2001 - 2000
FORD	MUSTANG	V-8, 4.6 L	2004 - 1999
LINCOLN	NAVIGATOR	V-8, 5.4 L	2007 - 1998
LINCOLN	AVIATOR	V-8, 4.6 L	2003 - 2005
LINCOLN	LS	V-8, 3.9 L	2003 - 2000
LAND ROVER	FREELANDER	V-6, 2.5 L	2005 - 2002
FORD	ESCORT	4 CIL, 2.0 L	2000 - 1998
FORD	FOCUS	4 CIL, 2.0 L	2004 - 2004

## Aplicación por Producto

FORD	EXPEDITION	V-8, 4.6 L	2004	-	1997
FORD	MUSTANG	V-6, 3.8 L	2001	-	1998
FORD	EXCURSION	V-8, 5.4 L	2002	-	2001
MERCURY	SABLE	V-6, 3.0 L	2000	-	1996
FORD	E SERIES VAN	V-6, 4.2 L	2003	-	2000
FORD	E SERIES VAN	V-8, 4.6 L	2006	-	1999
FORD	E SERIES VAN	V-8, 5.4 L	2007	-	2001
FORD	ESCAPE	4 CIL, 2.0 L	2002	-	2002
HONDA	PILOT	V-6, 3.5 L	2007	-	2003
MERCURY	MYSTIQUE	4 CIL, 2.0 L	1999	-	1999
FORD	RANGER	4 CIL, 2.5 L	2001	-	1999
HONDA	ACCORD	4 CIL, 2.3 L	2002	-	1999
FORD	LOBO	V-8, 4.6 L	2007	-	2002
HONDA	CIVIC	4 CIL, 1.6 L	2000	-	1998
FORD	RANGER	4 CIL, 2.3 L	2003	-	1997
HONDA	ACCORD	V-6, 3.0 L	2007	-	1999
HONDA	CIVIC	4 CIL, 1.7 L	2003	-	2001
FORD	LOBO	V-8, 5.4 L	2007	-	2003
FORD	F-450 SUPER DUTY	V-8, 7.3 L	2003	-	2001
FORD	FREESTAR	V-6, 4.2 L	2007	-	2004
FORD	RANGER	V-6, 3.0 L	2000	-	1996
FORD	RANGER	V-6, 4.0 L	2000	-	1999
FORD	F-450 SUPER DUTY	V-10, 6.8 L	2006	-	2010
FORD	F-550 SUPER DUTY	V-10, 6.8 L	2008	-	2010
HONDA	CR-V	4 CIL, 2.0 L	2001	-	1999
FORD	FREESTAR	V-6, 3.9 L	2007	-	2004
FORD	F-450 SUPER DUTY	V-8, 7.5 L	1997	-	1997

NISSAN	SENTRA	4 CIL, 1.8 L	2006	-	2000
NISSAN	QUEST	6 CIL, 3.3 L	2002	-	2002
NISSAN	PATHFINDER	V-6, 4.0 L	2007	-	2010
NISSAN	FRONTIER	V-6, 4.0 L	2007	-	2005
NISSAN	FRONTIER	4 CIL, 2.5 L	2007	-	2005
NISSAN	FRONTIER	4 CIL, 2.4 L	2004	-	1999
INFINITI	Q45	V-8, 4.5 L	2003	-	2002
NISSAN	MURANO	6 CIL, 3.5 L	2006	-	2004
NISSAN	FRONTIER	V-6, 3.3 L	2004	-	1999
NISSAN	ARMADA	V-8, 5.6 L	2006	-	2010
NISSAN	TSURU	4 CIL, 1.6 L	2005	-	2010
NISSAN	TIIDA	4 CIL, 1.8 L	2008	-	2010
NISSAN	ROGUE	4 CIL, 2.5 L	2008	-	2010
NISSAN	QUEST	V-6, 3.5 L	2007	-	2009
NISSAN	XTERRA	4 CIL, 2.4 L	2004	-	2000
NISSAN	SENTRA	4 CIL, 2.5 L	2006	-	2010
NISSAN	SENTRA	4 CIL, 2.0 L	2008	-	2010
NISSAN	MURANO	V-6, 3.5 L	2008	-	2010
NISSAN	FRONTIER	V6, 4.0 L	2008	-	2008
NISSAN	XTERRA	V-6, 4.0 L	2007	-	2005
NISSAN	350Z	V-6, 3.5 L	2006	-	2009
NISSAN	QUEST	V-6, 3.3 L	2001	-	1998
INFINITI	INFINITI Q45	V-8, 4.1 L	2001	-	1999
NISSAN	MAXIMA	V-6, 3.5 L	2007	-	2008
NISSAN	LUCCINO	4 CIL, 2.0 L	1998	-	1996
NISSAN	ALTIMA	V-6, 3.5 L	2008	-	2009
NISSAN	QUEST	V-6, 3.0 L	1998	-	1997
NISSAN	ALTIMA	4 CIL, 2.5 L	2008	-	2010
NISSAN	TITAN	V-8, 5.6 L	2008	-	2009
NISSAN	370Z	V-6, 3.7 L	2009	-	2009
NISSAN	XTERRA	V-6, 3.3 L	2002	-	2000
NISSAN	QUEST	6 CIL, 3.5 L	2006	-	2004
INFINITI	INFINITI I30	V-6, 3.0 L	2001	-	1997
NISSAN	X-TRAIL	4 CIL, 2.5 L	2008	-	2008
RENAULT	KOLEOS	4 CIL, 2.5 L	2009	-	2010

31111

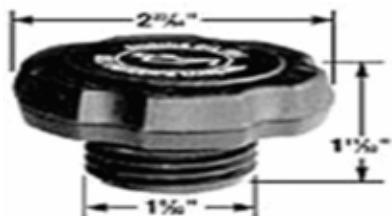

PONTIAC	SUNFIRE	4 CIL, 2.2 L	1999	-	1999
PONTIAC	GRAND AM	4 CIL, 2.4 L	2001	-	1998
PONTIAC	FIREBIRD TRANS AM	V-8, 5.7 L	1997	-	1997
CHEVROLET	CAVALIER	4 CIL, 2.4 L	1999	-	1996
PONTIAC	SUNFIRE	4 CIL, 2.4 L	2002	-	1999

31115



INFINITI	INFINITI Q45	V-8, 4.5 L	2003	-	2002
----------	--------------	------------	------	---	------

31117

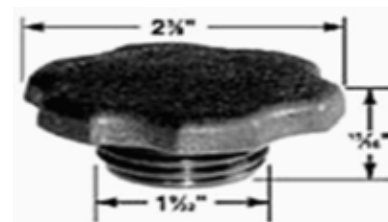

FORD	ZX2	4 CIL, 2.0 L	2001	-	2000
FORD	EXPLORER SPORT TRAC	V-6, 4.0 L	2001	-	2001
FORD	EXPLORER	V-6, 4.0 L	2001	-	2000
MAZDA	CX-7	4 CIL, 2.3 L	2008	-	2006
MAZDA	CX-9	V-6, 3.7 L	2008	-	2007
FORD	ESCAPE	4 CIL, 2.0 L	2001	-	2001
FORD	ESCORT	4 CIL, 2.0 L	2002	-	2002

## Aplicación por Producto

LINCOLN	LS	V-8, 3.9 L	2006 - 2004
LINCOLN	TOWN CAR	V-8, 4.6 L	2006 - 2005

**31118**



DODGE	CHARGER	V-6, 3.5 L	2008 - 2007
DODGE	CHARGER	V-8, 5.7 L	2008 - 2009
DODGE	CHARGER	V-8, 6.1 L	2008 - 2009
MINI	COOPER	4 CIL, 1.6 L	2006 - 2005
DODGE	INTREPID	V-6, 3.2 L	2001 - 1998
DODGE	CALIBER	4 CIL, 2.4 L	2008 - 2009
DODGE	STRATUS	V-6, 2.5 L	2000 - 2000
CHRYSLER	VOYAGER	V-6, 3.3 L	2007 - 1999
DODGE	CARAVAN	4 CIL, 2.4 L	2002 - 2002
DODGE	CARAVAN	V-6, 3.0 L	2002 - 2002
DODGE	CARAVAN	V-6, 3.3 L	2007 - 2002
DODGE	CARAVAN	V-6, 3.3 L FLEX	2003 - 2001
DODGE	CARAVAN	V-6, 3.8 L	2002 - 2002
DODGE	NEON	4 CIL, 2.4 L	2006 - 2003
CHRYSLER	SEBRING	4 CIL, 2.4 L	2006 - 1999
CHRYSLER	300 C	V-8, 5.7 L	2006 - 2009
CHRYSLER	300 C	V-8, 6.1 L	2006 - 2005
CHRYSLER	300M	V-6, 3.5 L	2004 - 1999
CHRYSLER	CONCORDE	V-6, 2.7 L	2000 - 1999
CHRYSLER	CONCORDE	V-6, 3.2 L	2001 - 1998
CHRYSLER	GRAND VOYAGER	V-6, 3.8 L	2000 - 2000
DODGE	AVENGER	4 CIL, 2.0 L	2008 - 2009
MITSUBISHI	OUTLANDER	V-6, 3.0 L	2007 - 2008
DODGE	AVENGER	4 CIL, 2.4 L	2008 - 2009
CHRYSLER	GRAND VOYAGER	V-6, 3.3 L	2000 - 1999
CHRYSLER	GRAND VOYAGER	V-6, 3.8 L	1999 - 1999
CHRYSLER	TOWN & COUNTRY	V-6, 3.3 L	2003 - 1999
CHRYSLER	TOWN & COUNTRY	V-6, 3.8 L	2007 - 1999
CHRYSLER	VOYAGER	V-6, 3.0 L	2001 - 2000
CHRYSLER	VOYAGER	V-6, 3.8 L	1999 - 1999
DODGE	DURANGO	V-6, 3.9 L	1999 - 1999
CHRYSLER	PT CRUISER	4 CIL, 2.4 L	2004 - 2010
JEEP	GRAND CHEROKEE	V-8, 4.0 L	2001 - 1999
JEEP	WRANGLER	V-6, 3.8 L	2007 - 2009
JEEP	WRANGLER	6 CIL, 4.0 L	2006 - 1999
JEEP	WRANGLER	4 CIL, 2.4 L	2006 - 2003
JEEP	PATRIOT	4 CIL, 2.4 L	2008 - 2010
JEEP	GRAND CHEROKEE	V-8, 6.1 L	2008 - 2009
JEEP	GRAND CHEROKEE	V-8, 5.9 L	1998 - 1998
DODGE	DURANGO	V-8, 5.9 L	2003 - 1999

JEEP	GRAND CHEROKEE	V-8, 4.7 L	2002 - 1999
DODGE	RAM SERIES PICKUP	V-8, 4.7L	2002 - 2002
JEEP	GRAND CHEROKEE	V-6, 4.0 L	2004 - 2003
JEEP	GRAND CHEROKEE	6 CIL, 4.0 L	2002 - 1996
JEEP	COMPASS	4 CIL, 2.4 L	2008 - 2010
JEEP	COMMANDER	V-8, 5.7 L	2008 - 2009
JEEP	CHEROKEE	6 CIL, 4.0 L	2001 - 1996
JEEP	CHEROKEE	4 CIL, 2.5 L	1998 - 1998
JEEP	GRAND CHEROKEE	V-8, 5.7 L	2007 - 2009
DODGE	RAM 2500	V-8, 5.9 L	2002 - 2002
DODGE	DURANGO	V-8, 5.7 L	2008 - 2009
CHRYSLER	300 C	V-6, 3.5 L	2006 - 2005
DODGE	JOURNEY	4 CIL, 2.4 L	2009 - 2010
DODGE	ADVENTURER	V-6, 3.3 L	1999 - 1999
DODGE	RAM 1500	V-6, 3.7 L	2002 - 2002
DODGE	RAM 1500	V-6, 3.9 L	2001 - 1999
JEEP	WRANGLER	V-6, 4.0 L	2004 - 2004
DODGE	RAM 2500	V-8, 5.7 L	2009 - 2009
DODGE	RAM WAGON 3500	V-8, 5.2 L	2000 - 2000
DODGE	RAM 4000	V-6, 5.9 L DIESEL	2007 - 2008
DODGE	RAM 4000	V-6, 6.7 L DIESEL	2008 - 2009
DODGE	RAM MAXI VAN 1500	V-6, 3.9 L	2002 - 2002
DODGE	RAM MAXI VAN 3500	V-8, 5.9 L	2002 - 2002
DODGE	RAM MAXI WAGON 3500	V-8, 5.9 L	2002 - 2002
DODGE	RAM SERIES PICKUP	V-6, 3.7 L	2002 - 2002
DODGE	DURANGO	V-8, 5.2 L	2000 - 1998
DODGE	RAM 2500	V-8, 4.7L	2003 - 2002

**31119**

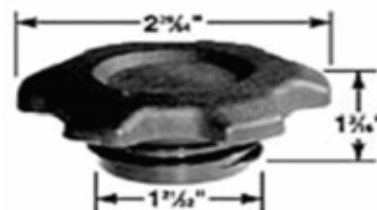

SUBARU	IMPREZA	4 CIL, 2.5 L	2007 - 2006
SUBARU	B9 TRIBECA	6 CIL, 3.0 L	2007 - 2006
SUBARU	LEGACY	4 CIL, 2.5 L	2007 - 2006
SUBARU	FORESTER	4 CIL, 2.5 L	2007 - 2006
SUBARU	OUTBACK	4 CIL, 2.5 L	2007 - 2006

**31120**

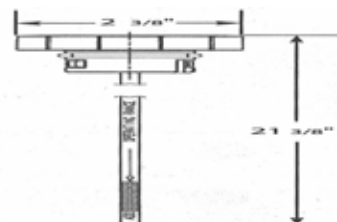

PONTIAC	SUNFIRE	4 CIL, 2.4 L	1997 - 1997
---------	---------	--------------	-------------

## Aplicación por Producto

31121

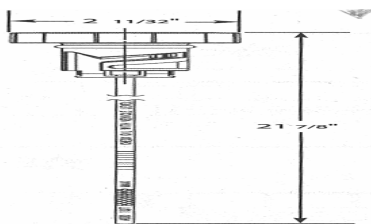

PONTIAC	SUNFIRE	4 CIL, 2.2 L	2001 - 2000
CHEVROLET	CAVALIER	4 CIL, 2.2 L	2001 - 1998

31124



CHEVROLET	S-10	4 CIL, 2.2 L	1998 - 1996
-----------	------	--------------	-------------

31275

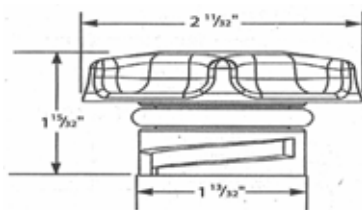

LINCOLN	TOWN CAR	V-8, 4.6 L	2004 - 2003
FORD	F-450 SUPER DUTY	V-10, 6.8 L	2008 - 2010
FORD	LOBO	V-8, 5.4 L	2004 - 2004
FORD	E SERIES VAN	V-8, 4.6 L	2008 - 2010
FORD	EXPLORER SPORT TRAC	V-6, 4.0 L	2006 - 2009
FORD	E SERIES VAN	V-8, 5.4 L	2004 - 2010
FORD	EDGE	V-6, 3.5 L	2007 - 2010
FORD	ESCAPE	V-6, 3.0 L	2007 - 2009
FORD	F-550 SUPER DUTY	V-10, 6.8 L	2008 - 2010
LINCOLN	MKX	V-6, 3.5 L	2008 - 2007
FORD	EXPEDITION	V-8, 5.4 L	2005 - 2008
FORD	EXPLORER	V-6, 4.0 L	2007 - 2009
FORD	EXPLORER	V-8, 4.6 L	2007 - 2009
FORD	EXPLORER SPORT TRAC	V-8, 4.6 L	2007 - 2009
LINCOLN	MARK LT	V-8, 5.4 L	2008 - 2007
FORD	RANGER	V-6, 4.0 L	2001 - 2001
FORD	FOCUS	4 CIL, 2.0 L	2003 - 2000
MERCURY	GRAND MARQUIS	V-8, 4.6 L	2005 - 2004
FORD	FIVE HUNDRED	V-6, 3.0 L	2007 - 2005
MERCURY	MILAN	V-6, 3.0 L	2007 - 2006

FORD	ESCORT	4 CIL, 2.0 L	2001 - 2001
FORD	CROWN VICTORIA	V-8, 4.6 L	2004 - 2003
LAND ROVER	RANGE ROVER	V-8, 4.4 L	2006 - 2008
FORD	RANGER	4 CIL, 2.3 L	2001 - 2010
FORD	MUSTANG	V-6, 4.0 L	2007 - 2005
MERCURY	SABLE	V-6, 3.0 L	2005 - 2001
FORD	RANGER	V-6, 3.0 L	2002 - 2001
MERCURY	MARINER	V-6, 3.0 L	2007 - 2009
LINCOLN	LS	V-6, 3.0 L	2001 - 2000
FORD	MUSTANG	V-8, 4.6 L	2007 - 2009
LINCOLN	MKZ	V-6, 3.5 L	2008 - 2007
FORD	FUSION	V-6, 3.0 L	2008 - 2007

31278

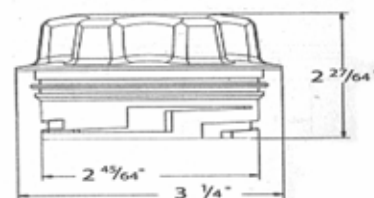

DODGE	NITRO	V-6, 3.7 L	2008 - 2010
JEEP	GRAND CHEROKEE	V-8, 4.7 L	2007 - 1999
DODGE	DURANGO	V-8, 4.7 L	2006 - 2001
JEEP	GRAND CHEROKEE	V-6, 3.7 L	2007 - 2005
DODGE	RAM 1500	V-6, 3.7 L	2005 - 2004
JEEP	LIBERTY	V-6, 3.7 L	2007 - 2004
DODGE	DURANGO	V-6, 3.7 L	2005 - 2004
DODGE	DAKOTA	V-6, 3.7 L	2008 - 2007

31279

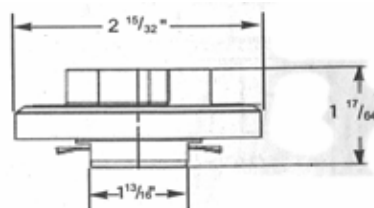

TOYOTA	SIENNA	V-6, 3.0 L	2003 - 2003
TOYOTA	CAMRY	V-6, 3.0 L	2006 - 2002
TOYOTA	SIENNA	V-6, 3.3 L	2006 - 2004
TOYOTA	SOLARA	V-6, 3.3 L	2006 - 2005



## Aplicación por Producto

### 31280

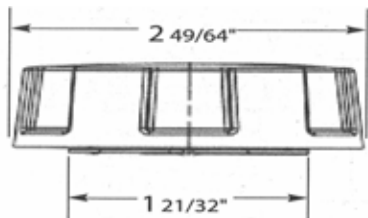

VOLVO	S60	5 CIL, 2.5 L	2006	-	2004
VOLVO	S80	6 CIL, 2.9 L	2005	-	1999
VOLVO	S80	6 CIL, 2.8 L	2001	-	2000
VOLVO	C70	5 CIL, 2.4 L	2004	-	1999
VOLVO	V40	4 CIL, 1.9 L	2001	-	2001
VOLVO	S60	5 CIL, 2.4 L	2003	-	2001
VOLVO	V70	5 CIL, 2.3 L	2001	-	1999
VOLVO	S70	5 CIL, 2.4 L	1999	-	1999
VOLVO	C70	5 CIL, 2.3 L	2004	-	2001
VOLVO	S40	4 CIL, 1.9 L	2001	-	2000
VOLVO	V70	5 CIL, 2.4 L	2001	-	1999
VOLVO	S70	5 CIL, 2.3 L	1999	-	1999
VOLVO	XC90	5 CIL, 2.5 L	2006	-	2003
VOLVO	S60	5 CIL, 2.3 L	2001	-	2001

### 31281



MERCEDES BE	CLK55	V-8, 5.5 L	2006	-	2001
-------------	-------	------------	------	---	------

### 31282



BMW	323CI	V-6, 2.5 L	2000	-	2000
BMW	X3	6 CIL, 3.0 L	2006	-	2005
BMW	X5	6 CIL, 3.0 L	2006	-	2005
BMW	328I	V-6, 2.8 L	1999	-	1999
BMW	323I	V-6, 2.5 L	2000	-	1999
BMW	760LI	V-12, 6.0 L	2005	-	2005
BMW	760I	V-12, 6.0 L	2005	-	2005
LAND ROVER	RANGE ROVER	V-8, 4.4 L	2005	-	2003
BMW	M5	V-8, 5.0 L	2002	-	2000

BMW	318TI	4 CIL, 1.9 L	1998	-	1998
BMW	318I	4 CIL, 1.9 L	1998	-	1998
BMW	323IS	V-6, 2.5 L	1998	-	1998
BMW	540I	V-8, 4.4 L	2000	-	1998
BMW	645CI	V-8, 4.4 L	2005	-	2005
BMW	325XI	6 CIL, 2.5 L	2005	-	2005
BMW	740I	V-8, 4.4 L	2000	-	2000
BMW	Z3	V-6, 2.8 L	2000	-	2000
BMW	740IL	V-8, 4.4 L	2000	-	2000
BMW	745I	V-8, 4.4 L	2005	-	2005
BMW	745LI	V-8, 4.4 L	2005	-	2005
BMW	330XI	6 CIL, 3.0 L	2006	-	2005
BMW	Z3	V-6, 2.5 L	2000	-	1999
BMW	528I	V-6, 2.8 L	2000	-	2000
BMW	525I	6 CIL, 2.5 L	2001	-	2001

### 31284

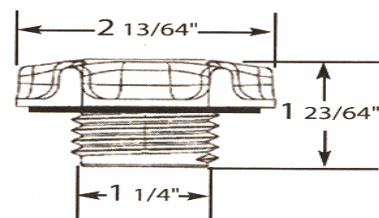

ACURA	RL	V-6, 3.7 L	2009	-	2010
ACURA	TL	V-6, 3.2 L	2008	-	2006
ACURA	TL	V-6, 3.5 L	2008	-	2009
HONDA	ACCORD	4 CIL, 2.4 L	2007	-	2010
SUZUKI	GRAND VITARA	V-6, 2.7 L	2008	-	2006
ACURA	RL	V-6, 3.5 L	2008	-	2006
ACURA	MDX	V-6, 3.5 L	2006	-	2006
HONDA	CR-V	4 CIL, 2.0 L	2002	-	2002
SUZUKI	XL-7	V-6, 2.7 L	2006	-	2005
HONDA	CR-V	4 CIL, 2.4 L	2007	-	2009
HONDA	ODYSSEY	V-6, 3.5 L	2007	-	2010
ACURA	MDX	V-6, 3.7 L	2008	-	2007
HONDA	PILOT	V-6, 3.5 L	2004	-	2010
HONDA	RIDGELINE	V-6, 3.5 L	2006	-	2009
HONDA	FIT	4 CIL, 1.5 L	2008	-	2010
HONDA	CIVIC HIBRIDO	4 CIL, 1.3 L	2007	-	2010
HONDA	CIVIC	4 CIL, 1.8 L	2007	-	2010
HONDA	CIVIC	4 CIL, 1.7 L	2005	-	2004
SUZUKI	SX4	4 CIL, 2.0 L	2008	-	2007
ACURA	TL	V-6, 3.7 L	2009	-	2009
HONDA	CITY	4 CIL, 1.5 L	2010	-	2010

31285



TOYOTA	FJ CRUISER	V-6, 4.0 L	2008	-	2007
TOYOTA	SIENNA	V-6, 3.5 L	2008	-	2007
TOYOTA	HIGHLANDER	V-6, 3.5 L	2009	-	2009
TOYOTA	RAV 4	V-6, 3.5 L	2008	-	2010
TOYOTA	TACOMA	V-6, 4.0 L	2008	-	2006
TOYOTA	MATRIX	4 CIL, 1.8 L	2008	-	2005
TOYOTA	COROLLA	4 CIL, 1.8 L	2008	-	2005
TOYOTA	CAMRY	V-6, 3.5 L	2008	-	2007
TOYOTA	RAV 4	4 CIL, 2.4 L	2006	-	2008
TOYOTA	TUNDRA	V-8, 5.7 L	2009	-	2010
TOYOTA	CAMRY	4 CIL, 2.4 L	2008	-	2003
TOYOTA	YARIS	4 CIL, 1.5 L	2008	-	2005
TOYOTA	RAV 4	4 CIL, 2.5 L	2009	-	2010

31291



CADILLAC	CATERA	V-6, 3.0 L	2001	-	1998
CHEVROLET	OPTRA	4 CIL, 2.0 L	2006	-	2010

31295



FORD	FUSION	4 CIL, 2.3 L	2008	-	2007
FORD	ESCAPE	4 CIL, 2.3 L	2007	-	2005
MAZDA	MAZDA 3	4 CIL, 2.3 L	2007	-	2006
FORD	FOCUS	4 CIL, 2.0 L	2007	-	2010
MAZDA	MAZDA 3	4 CIL, 2.0 L	2007	-	2009
MAZDA	MX-5 MIATA	4 CIL, 2.0 L	2007	-	2006
MAZDA	MAZDA 5	4 CIL, 2.3 L	2007	-	2006
MAZDA	MAZDA 6	V-6, 3.0 L	2008	-	2008
MAZDA	MAZDA 6	4 CIL, 2.3 L	2007	-	2008

31296



DODGE	DURANGO	V-8, 5.7 L	2007	-	2006
DODGE	RAM 3500	V-8, 5.7 L	2007	-	2003

31297



SAAB	9 - 5	4 CIL, 2.3 L	2007	-	2002
------	-------	--------------	------	---	------

31298



LAND ROVER	DISCOVERY	V-8, 4.0 L	2000	-	2004
------------	-----------	------------	------	---	------

31299



CHRYSLER	ASPEN	V-8, 5.7 L	2007	-	2009
CHRYSLER	300 C	V-6, 3.5 L	2007	-	2009
DODGE	CHARGER	V-6, 3.5 L	2009	-	2009
DODGE	NITRO	V-6, 4.0 L	2009	-	2010
DODGE	RAM 2500	V-8, 5.7 L	2008	-	2008

**Tapones de Gasolina**

### 31525



JEEP	GRAND CHEROKEE	6 CIL, 4.0 L	1998 - 1998
------	----------------	--------------	-------------

### 31615



FORD	F-450 SUPER DUTY	V-8, 7.5 L	1997 - 1997
JEEP	WRANGLER	4 CIL, 2.5 L	2000 - 1997
LAND ROVER	DISCOVERY	V-8, 4.0 L	1999 - 2004
DODGE	DURANGO	V-6, 3.9 L	1999 - 1998
CHEVROLET	ZAFIRA	4 CIL, 1.8 L	2003 - 2000
FORD	LOBO	V-8, 5.4 L	2003 - 2003
FORD	F-350 SUPER DUTY	V-8, 5.4 L	2006 - 1999
CHEVROLET	ASTRA	4 CIL, 2.0 L	2006 - 2004
CHEVROLET	CAVALIER	4 CIL, 2.4 L	1996 - 1996
FORD	F-450 SUPER DUTY	V-8, 7.3 L	2003 - 2001
CHEVROLET	ASTRA	4 CIL, 1.8 L	2003 - 2000
HYUNDAI	ATOS	4 CIL, 1.0 L	2004 - 2000
NISSAN	SENTRA	4 CIL, 1.8 L	2000 - 2000
DODGE	INTREPID	V-6, 3.5 L	1999 - 1999
NISSAN	SENTRA	4 CIL, 1.6 L	1999 - 1996
NISSAN	XTERRA	4 CIL, 2.4 L	2000 - 2000
FORD	SUPER DUTY PICKUP	V-8, 6.0 L DIESEL	2003 - 2003
FORD	SUPER DUTY VAN	V-6, 4.2 L	2001 - 2001
DODGE	STRATUS	4 CIL, 2.0 L	1997 - 1997
CHEVROLET	ZAFIRA	4 CIL, 2.4 L	2006 - 2004
DODGE	STRATUS	4 CIL, 2.4 L	1998 - 1997
FORD	FIESTA	4 CIL, 1.6 L	2005 - 2003
DODGE	INTREPID	V-6, 3.2 L	1999 - 1999
CHEVROLET	ASTRA	4 CIL, 2.2 L	2003 - 2000
DODGE	STRATUS	V-6, 2.5 L	1998 - 1997
NISSAN	XTERRA	V-6, 3.3 L	2000 - 2000
DODGE	INTREPID	V-6, 2.7 L	1999 - 1999
FORD	SUPER DUTY PICKUP	V-8, 7.3 L	2000 - 2000
FORD	SUPER DUTY PICKUP	V-8, 5.4 L	2003 - 2000
FORD	SUPER DUTY PICKUP	V-10, 6.8 L	2000 - 2003
CHEVROLET	ASTRA	4 CIL, 2.4 L	2006 - 2004
FORD	RANGER	4 CIL, 2.3 L	1997 - 1997
FORD	F-450 SUPER DUTY	V-10, 6.8 L	2006 - 1999
JEEP	WRANGLER	6 CIL, 4.0 L	2000 - 1997
CHEVROLET	ZAFIRA	4 CIL, 2.2 L	2003 - 2000
JEEP	GRAND CHEROKEE	V-8, 5.2 L	1998 - 1997
DODGE	RAM 3500	V-8, 5.9 L	1996 - 1996
CHRYSLER	CONCORDE	V-6, 3.2 L	1999 - 1998
DODGE	DURANGO	V-8, 5.2 L	1999 - 1998
NISSAN	ALTIMA	V-6, 3.5 L	2002 - 2002
FORD	F SERIES PICKUP	V-8, 5.4 L	2002 - 2002
NISSAN	ALTIMA	4 CIL, 2.4 L	2002 - 1999
DODGE	RAM 4000	V-8, 5.9 L	1996 - 1996

### 31612



SUZUKI	XL-7	V-6, 2.7 L	2006 - 2005
CHEVROLET	TRACKER	4 CIL, 2.0 L	2003 - 1999
SUZUKI	AERIO	4 CIL, 2.3 L	2006 - 2005
CHEVROLET	TRACKER	V-6, 2.5 L	2004 - 2002
CHEVROLET	TRACKER	4 CIL, 1.6 L	2000 - 1997

### 31613



AUDI	A4	V-6, 3.0 L	2006 - 2004
AUDI	A4	4 CIL, 2.0 L	2007 - 2007
AUDI	A4	4 CIL, 1.8 L	2006 - 2004
AUDI	A3	V-6, 3.2 L	2007 - 2008
VOLKSWAGEN	BEETLE	4 CIL, 1.8 L	2005 - 2004
AUDI	A6	V-6, 3.2 L	2007 - 2007
VOLKSWAGEN	BEETLE	4 CIL, 2.0 L	2008 - 2004
VOLKSWAGEN	BEETLE	5 CIL, 2.5 L	2008 - 2006
AUDI	A8 QUATTRO	V-8, 4.2 L	2005 - 2005
VOLKSWAGEN	BORA SPORTWAGEN	5 CIL, 2.5 L	2008 - 2009
VOLKSWAGEN	BORA	5 CIL, 2.5 L	2008 - 2005
VOLKSWAGEN	BORA	5 CIL, 2.5 L	2009 - 2009
AUDI	A3	4 CIL, 2.0 L	2007 - 2008
VOLKSWAGEN	JETTA	4 CIL, 2.0 L	2009 - 2010
AUDI	A4	V-6, 3.2 L	2007 - 2007

## Aplicación por Producto

JEEP	GRAND CHEROKEE	V-8, 4.0 L	2000 - 1999
JEEP	GRAND CHEROKEE	V-8, 4.7 L	2000 - 1999
JEEP	GRAND CHEROKEE	6 CIL, 4.0 L	2000 - 1997
CHRYSLER	CONCORDE	V-6, 2.7 L	1999 - 1998
FORD	MUSTANG	V-6, 3.8 L	1996 - 1996
DODGE	DURANGO	V-8, 5.9 L	1999 - 1998
LAND ROVER	RANGE ROVER	V-8, 4.6 L	1998 - 1998
NISSAN	SENTRA	4 CIL, 2.0 L	2000 - 1998
JEEP	GRAND CHEROKEE	V-8, 5.9 L	1998 - 1998
CHEVROLET	ZAFIRA	4 CIL, 2.0 L	2006 - 2004
LAND ROVER	DISCOVERY SERIES II	V-8, 4.0 L	2000 - 1999
LAND ROVER	RANGE ROVER	V-8, 4.0 L	1999 - 1998
NISSAN	PATHFINDER	V-6, 3.3 L	2000 - 1999

### 31633



CHEVROLET	CAMARO Z28	V-8, 5.7 L	1996 - 1996
PONTIAC	FIREBIRD TRANS AM	V-8, 5.7 L	1997 - 1997
CHEVROLET	CAMARO Z28	V-6, 3.8 L	1997 - 1996

### 31634



CHEVROLET	CAMARO Z28	V-8, 5.7 L	1996 - 1996
-----------	------------	------------	-------------

### 31636

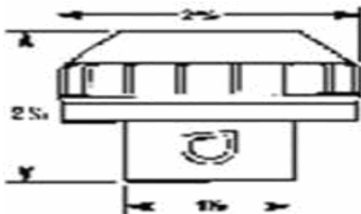

CHEVROLET	CENTURY	V-6, 3.1 L	1999 - 1997
CHEVROLET	CORVETTE	V-8, 5.7 L	2004 - 1997
CHEVROLET	CAVALIER	4 CIL, 2.4 L	1999 - 1997
PONTIAC	GRAND PRIX	V-6, 3.1 L	2002 - 1997
CHEVROLET	IMPALA	V-6, 3.8 L	2005 - 2000
CHEVROLET	MALIBU	V-6, 3.1 L	2003 - 1997

CHEVROLET	IMPALA	V-6, 3.4 L	2005 - 2000
PONTIAC	GRAND PRIX	V-6, 3.8 L	2004 - 1997
PONTIAC	SUNFIRE	4 CIL, 2.2 L	2004 - 1997
PONTIAC	GRAND AM	V-6, 3.4 L	2005 - 1999
PONTIAC	GRAND AM	4 CIL, 2.4 L	2001 - 1998
PONTIAC	SUNFIRE	4 CIL, 2.3 L	2004 - 1997
PONTIAC	SUNFIRE	4 CIL, 2.4 L	1998 - 1997
PONTIAC	GRAND AM	V-6, 3.1 L	1998 - 1997
CHEVROLET	CORVETTE	V-8, 6.0 L	2007 - 2005
PONTIAC	AZTEK	V-6, 3.4 L	2005 - 2001
CHEVROLET	MALIBU	4 CIL, 2.4 L	1998 - 1997
PONTIAC	GRAND AM	4 CIL, 2.2 L	2003 - 2002
CHEVROLET	CAVALIER	4 CIL, 2.2 L	2005 - 1997
CHEVROLET	EXPRESS	V-8, 8.1 L	2002 - 2001
CHEVROLET	TRAILBLAZER	6 CIL, 4.2 L	2004 - 2002
CHEVROLET	TRAILBLAZER	V-8, 5.3 L	2003 - 2003
CHEVROLET	VENTURE	V-6, 3.4 L	2005 - 1998
CHEVROLET	EXPRESS	V-8, 6.0 L	2003 - 2003
CHEVROLET	EXPRESS	V-8, 5.7 L	2002 - 1999
CADILLAC	SRX	V-8, 4.6 L	2004 - 2004
CHEVROLET	EXPRESS	V-8, 5.3 L	2007 - 2003
CHEVROLET	EXPRESS	V-8, 7.4 L	1999 - 1999
CHEVROLET	MONTE CARLO	V-6, 3.4 L	2005 - 2004
CHEVROLET	EXPRESS	V-8, 5.0 L	2002 - 2000
CHEVROLET	BLAZER	V-6, 4.3 L	2005 - 1996
CHEVROLET	CAMARO Z28	V-8, 5.7 L	2002 - 2000
CHEVROLET	MONTE CARLO	V-6, 3.8 L	2005 - 2004
CHEVROLET	EXPRESS	V-6, 4.3 L	2003 - 2001
OLDSMOBILE	EIGHTY EIGHT	V-6, 3.8 L	1999 - 1998
PONTIAC	BONNEVILLE	V-6, 3.8 L	2005 - 1997
CHEVROLET	LUMINA	V-6, 3.1 L	1998 - 1998
CHEVROLET	S-10	4 CIL, 2.2 L	2001 - 1996
CADILLAC	SEVILLE	V-8, 4.6 L	2004 - 1998
CHEVROLET	EXPRESS VAN	V-6, 4.3 L	2000 - 1998
PONTIAC	FIREBIRD TRANS AM	V-8, 5.7 L	2002 - 1999
CHEVROLET	EXPRESS VAN PASAJEROS	V-6, 4.3 L	2000 - 1998
CHEVROLET	S-10	V-6, 4.3 L	2002 - 1996
CHEVROLET	MALIBU	V-6, 3.5 L	2003 - 2003
CHEVROLET	CAMARO Z28	V-6, 3.8 L	2002 - 1999
CADILLAC	DEVILLE	V-8, 4.6 L	2005 - 1997
CHEVROLET	EXPRESS CARGO VAN	V-8, 5.7 L	2000 - 1998
CADILLAC	CTS	V-6, 3.2 L	2004 - 2003

### 31637



## Aplicación por Producto

HONDA	CITY	4 CIL, 1.5 L	2010	-	2010
HONDA	ACCORD	V-6, 3.5 L	2008	-	2010
ACURA	TL	V-6, 3.7 L	2009	-	2009
ACURA	TSX	4 CIL, 2.4 L	2009	-	2009
HONDA	ACCORD	4 CIL, 2.4 L	2005	-	2010
ACURA	MDX	V-6, 3.5 L	2006	-	2006
FORD	CONTOUR	4 CIL, 2.0 L	2000	-	1998
FORD	FOCUS	4 CIL, 2.0 L	2003	-	2000
FORD	CONTOUR	V-6, 2.5 L	2000	-	1998
HONDA	PILOT	V-6, 3.5 L	2008	-	2010
HONDA	FIT	4 CIL, 1.5 L	2008	-	2010
ACURA	RL	V-6, 3.5 L	2008	-	2006
ACURA	TL	V-6, 3.5 L	2008	-	2009
HONDA	CIVIC	4 CIL, 1.8 L	2007	-	2010
HONDA	CR-V	4 CIL, 2.4 L	2007	-	2009
ACURA	RDX	4 CIL, 2.3 L	2008	-	2006
ACURA	MDX	V-6, 3.7 L	2008	-	2007
HONDA	RIDGELINE	V-6, 3.5 L	2006	-	2009
HONDA	ODYSSEY	V-6, 3.5 L	2007	-	2010
HONDA	CIVIC HIBRIDO	4 CIL, 1.3 L	2007	-	2010
ACURA	TL	V-6, 3.2 L	2008	-	2006
ACURA	RL	V-6, 3.7 L	2009	-	2010
MERCURY	MYSTIQUE	V-6, 2.5 L	2000	-	1998
MERCURY	MYSTIQUE	4 CIL, 2.0 L	2000	-	1998

### 31708



VOLKSWAGEN	BORA	5 CIL, 2.5 L	2009	-	2009
VOLKSWAGEN	BEETLE	5 CIL, 2.5 L	2008	-	2006
VOLKSWAGEN	JETTA	4 CIL, 2.0 L	2009	-	2010
AUDI	A3	4 CIL, 2.0 L	2006	-	2008
VOLKSWAGEN	BORA	5 CIL, 2.5 L	2008	-	2005
AUDI	A3	V-6, 3.2 L	2007	-	2008
VOLKSWAGEN	BORA SPORTWAGEN	5 CIL, 2.5 L	2008	-	2009
AUDI	A4	4 CIL, 1.8 L	2005	-	2005

### 31733



CHEVROLET	CAMARO Z28	V-8, 5.7 L	1996	-	1996
CHEVROLET	CAMARO Z28	V-6, 3.8 L	1996	-	1996

### 31734

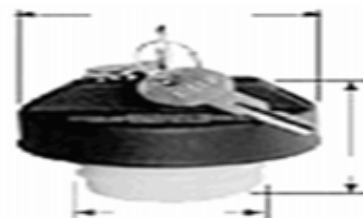

VOLKSWAGEN	DERBY	4 CIL, 1.8 L	1999	-	1999
CHEVROLET	VENTURE	V-6, 3.4 L	2004	-	1999
CHEVROLET	ASTRA	4 CIL, 1.8 L	2003	-	2000
CHEVROLET	CHEVY	4 CIL, 1.6 L	2009	-	2010
FORD	SUPER DUTY PICKUP	V-8, 5.4 L	2000	-	2000
PONTIAC	GRAND PRIX	V-6, 3.8 L	1997	-	1997
NISSAN	SENTRA	4 CIL, 2.0 L	2000	-	1998
LAND ROVER	DISCOVERY	V-8, 4.0 L	2000	-	2004
FORD	SUPER DUTY PICKUP	V-10, 6.8 L	2000	-	2000
CHEVROLET	ZAFIRA	4 CIL, 2.2 L	2003	-	2000
NISSAN	LUCCINO	4 CIL, 2.0 L	1996	-	1996
LAND ROVER	RANGE ROVER	V-8, 4.6 L	1999	-	1998
CHRYSLER	CONCORDE	V-6, 2.7 L	1999	-	1998
NISSAN	SENTRA	4 CIL, 1.8 L	2000	-	2000

### 31676

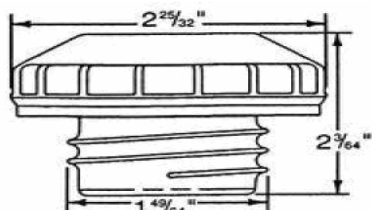

VOLKSWAGEN	TOUAREG	V-6, 3.6 L	2007	-	2007
VOLKSWAGEN	TOUAREG	V-6, 3.2 L	2006	-	2005
VOLKSWAGEN	TOUAREG	V-8, 4.2 L	2006	-	2005
VOLKSWAGEN	TOUAREG	V-8, 4.2 L	2007	-	2007
HUMMER	H1	V-8, 6.6 L	2007	-	2006

### 31703

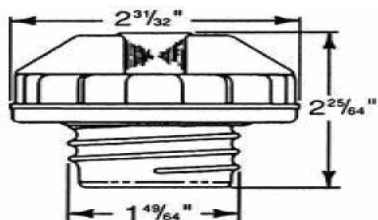

VOLKSWAGEN	TOUAREG	V-6, 3.6 L	2007	-	2007
VOLKSWAGEN	TOUAREG	V-8, 4.2 L	2007	-	2007

## Aplicación por Producto

JEEP	GRAND CHEROKEE	V-8, 5.2 L	1998 - 1997
NISSAN	PATHFINDER	V-6, 3.3 L	2000 - 1999
CHEVROLET	CHEVY C2 SEDAN	4 CIL, 1.6 L	2007 - 2004
DODGE	STRATUS	4 CIL, 2.0 L	1998 - 1997
JEEP	GRAND CHEROKEE	6 CIL, 4.0 L	2000 - 1997
CHEVROLET	CHEVY PICK-UP	4 CIL, 1.6 L	2006 - 2002
DODGE	INTREPID	V-6, 3.2 L	1999 - 1999
JEEP	GRAND CHEROKEE	V-8, 4.0 L	2000 - 1999
CHEVROLET	CHEVY C2	4 CIL, 1.6 L	2008 - 2004
JEEP	GRAND CHEROKEE	V-8, 4.7 L	2000 - 1999
LAND ROVER	RANGE ROVER	V-8, 4.0 L	1998 - 1998
CHEVROLET	ZAFIRA	4 CIL, 2.4 L	2006 - 2004
JEEP	WRANGLER	6 CIL, 4.0 L	2000 - 1997
JEEP	GRAND CHEROKEE	V-8, 5.9 L	1998 - 1998
DODGE	STRATUS	V-6, 2.5 L	1998 - 1997
FORD	MUSTANG	V-6, 3.8 L	1996 - 1996
DODGE	INTREPID	V-6, 2.7 L	1999 - 1999
JEEP	WRANGLER	4 CIL, 2.5 L	1999 - 1999
DODGE	STRATUS	4 CIL, 2.4 L	1998 - 1997
CHEVROLET	ASTRA	4 CIL, 2.4 L	2006 - 2004
DODGE	DURANGO	V-6, 3.9 L	1999 - 1998
CHEVROLET	CAVALIER	4 CIL, 2.4 L	1996 - 1996
CHEVROLET	ZAFIRA	4 CIL, 2.0 L	2006 - 2004
PONTIAC	GRAND PRIX	V-6, 3.1 L	1997 - 1997
CHEVROLET	ASTRA	4 CIL, 2.0 L	2006 - 2004
NISSAN	XTERRA	V-6, 3.3 L	2000 - 2000
CHRYSLER	CONCORDE	V-6, 3.2 L	1999 - 1998
NISSAN	ALTIMA	4 CIL, 2.4 L	2002 - 1999
DODGE	DURANGO	V-8, 5.9 L	1999 - 1998
CHEVROLET	ASTRA	4 CIL, 2.2 L	2003 - 2000
NISSAN	ALTIMA	V-6, 3.5 L	2002 - 2002
NISSAN	XTERRA	4 CIL, 2.4 L	2000 - 2000
DODGE	DURANGO	V-8, 5.2 L	1999 - 1998
CHEVROLET	ZAFIRA	4 CIL, 1.8 L	2003 - 2000
FORD	RANGER	V-6, 3.0 L	1996 - 1996

NISSAN	TSURU	4 CIL, 1.6 L	2005 - 2010
DODGE	INTREPID	V-6, 2.7 L	1999 - 1999
NISSAN	FRONTIER	4 CIL, 2.4 L	2000 - 1999
DODGE	INTREPID	V-6, 3.2 L	1999 - 1999
CHEVROLET	ASTRA	4 CIL, 2.2 L	2003 - 2000
NISSAN	PATHFINDER	V-6, 3.3 L	2000 - 1998
INFINITI	INFINITI Q45	V-8, 4.1 L	1999 - 1999
DODGE	DURANGO	V-8, 5.2 L	1999 - 1998
INFINITI	INFINITI I30	V-6, 3.0 L	2000 - 1997
NISSAN	XTERRA	V-6, 3.3 L	2000 - 2000
JEEP	GRAND CHEROKEE	V-8, 4.0 L	2000 - 1999
VOLKSWAGEN	POINTER	4 CIL, 1.8 L	2000 - 1998
JEEP	GRAND CHEROKEE	V-8, 4.7 L	2000 - 1999
CHRYSLER	SEBRING	V-6, 2.5 L	1999 - 1997
CHEVROLET	ZAFIRA	4 CIL, 1.8 L	2003 - 2000
JEEP	GRAND CHEROKEE	V-8, 5.9 L	1998 - 1998
DODGE	DURANGO	V-6, 3.9 L	1999 - 1998
DODGE	DURANGO	V-8, 5.9 L	1999 - 1998
NISSAN	FRONTIER	V-6, 3.3 L	2000 - 1999
HYUNDAI	ATOS	4 CIL, 1.1 L	2008 - 2010
CHEVROLET	ASTRA	4 CIL, 2.4 L	2006 - 2004
CHRYSLER	CONCORDE	V-6, 2.7 L	1999 - 1998
NISSAN	SENTRA	4 CIL, 1.8 L	2000 - 2000
CHEVROLET	ASTRA	4 CIL, 2.0 L	2006 - 2004
CHEVROLET	ASTRA	4 CIL, 1.8 L	2003 - 2000
NISSAN	SENTRA	4 CIL, 2.0 L	2000 - 1998
CHEVROLET	ZAFIRA	4 CIL, 2.4 L	2006 - 2004
CHEVROLET	ZAFIRA	4 CIL, 2.2 L	2003 - 2000
CHEVROLET	ZAFIRA	4 CIL, 2.0 L	2006 - 2004
NISSAN	ALTIMA	V-6, 3.5 L	2002 - 2002

31778



31748



CHRYSLER	SEBRING	4 CIL, 2.4 L	1999 - 1996
CHRYSLER	CONCORDE	V-6, 3.2 L	1999 - 1998
JEEP	WRANGLER	6 CIL, 4.0 L	2000 - 1997
NISSAN	XTERRA	4 CIL, 2.4 L	2000 - 2000
OLDSMOBILE	SILHOUETTE	V-6, 3.4 L	1996 - 1996
DODGE	RAM 1500	V-6, 3.9 L	1999 - 1999
NISSAN	QUEST	V-6, 3.0 L	1998 - 1997

JEEP	GRAND CHEROKEE	V-8, 4.0 L	2000 - 1999
CHEVROLET	ZAFIRA	4 CIL, 2.4 L	2006 - 2004
NISSAN	XTERRA	4 CIL, 2.4 L	2000 - 2000
DODGE	STRATUS	4 CIL, 2.0 L	1999 - 1997
CHRYSLER	CONCORDE	V-6, 2.7 L	1999 - 1998
DODGE	DURANGO	V-8, 5.9 L	1999 - 1998
CHEVROLET	ASTRA	4 CIL, 2.4 L	2006 - 2004
NISSAN	FRONTIER	V-6, 3.3 L	2000 - 1999
CHEVROLET	ZAFIRA	4 CIL, 2.2 L	2003 - 2000
CHEVROLET	CHEVY C2 SEDAN	4 CIL, 1.6 L	2008 - 2005
NISSAN	SENTRA	4 CIL, 1.8 L	2000 - 2000
NISSAN	TSURU	4 CIL, 1.6 L	2000 - 2010



## Aplicación por Producto

HYUNDAI	ATOS	4 CIL, 1.1 L	2008	-	2010
CHEVROLET	CHEVY C2	4 CIL, 1.6 L	2008	-	2004
NISSAN	XTERRA	V-6, 3.3 L	2000	-	2000
DODGE	INTREPID	V-6, 3.2 L	1999	-	1999
DODGE	DURANGO	V-8, 5.2 L	1999	-	1998
NISSAN	PATHFINDER	V-6, 3.3 L	2000	-	1999
CHEVROLET	ASTRA	4 CIL, 1.8 L	2003	-	2000
CHRYSLER	300M	V-6, 3.5 L	1999	-	1999
CHEVROLET	ZAFIRA	4 CIL, 2.0 L	2006	-	2004
NISSAN	ALTIMA	V-6, 3.5 L	2002	-	2002
DODGE	INTREPID	V-6, 3.5 L	1999	-	1999
JEEP	GRAND CHEROKEE	6 CIL, 4.0 L	2000	-	1997
NISSAN	ALTIMA	4 CIL, 2.4 L	2002	-	1999
CHEVROLET	CHEVY	4 CIL, 1.6 L	2009	-	2010
NISSAN	SENTRA	4 CIL, 2.0 L	2000	-	1998
NISSAN	QUEST	V-6, 3.3 L	1999	-	1999
JEEP	WRANGLER	4 CIL, 2.5 L	2000	-	1997
DODGE	STRATUS	V-6, 2.5 L	1998	-	1996
CHRYSLER	CONCORDE	V-6, 3.2 L	1999	-	1998
JEEP	GRAND CHEROKEE	V-8, 5.9 L	1998	-	1998
JEEP	WRANGLER	6 CIL, 4.0 L	2000	-	1997
JEEP	GRAND CHEROKEE	V-8, 4.7 L	2000	-	1999
NISSAN	FRONTIER	4 CIL, 2.4 L	2000	-	1999
CHEVROLET	ASTRA	4 CIL, 2.2 L	2003	-	2000
JEEP	GRAND CHEROKEE	V-8, 5.2 L	1998	-	1997
CHEVROLET	VENTURE	V-6, 3.4 L	1997	-	1997
DODGE	DURANGO	V-6, 3.9 L	1999	-	1998
CHEVROLET	ASTRA	4 CIL, 2.0 L	2006	-	2004
DODGE	INTREPID	V-6, 2.7 L	1999	-	1999
CHEVROLET	ZAFIRA	4 CIL, 1.8 L	2003	-	2000
CHEVROLET	CHEVY PICK-UP	4 CIL, 1.6 L	2006	-	2002
DODGE	STRATUS	4 CIL, 2.4 L	1999	-	1997

VOLVO	S80	6 CIL, 2.8 L	2001	-	2001
HONDA	CIVIC	4 CIL, 1.7 L	2004	-	2001
VOLVO	S80	6 CIL, 2.9 L	2001	-	2001
HONDA	ACCORD	4 CIL, 2.3 L	2002	-	1999
VOLVO	S40	4 CIL, 1.9 L	2001	-	2000
HONDA	CIVIC	4 CIL, 1.6 L	2000	-	1999
TOYOTA	CAMRY	4 CIL, 2.4 L	2008	-	2007
SUZUKI	GRAND VITARA	V-6, 2.7 L	2008	-	2006
VOLVO	S60	5 CIL, 2.3 L	2001	-	2001
SUZUKI	SX4	4 CIL, 2.0 L	2008	-	2010
TOYOTA	CAMRY	V-6, 3.5 L	2008	-	2007
TOYOTA	CAMRY	4 CIL, 2.2 L	2002	-	2001
VOLVO	C70	5 CIL, 2.4 L	2004	-	2000
HONDA	ODYSSEY	V-6, 3.5 L	2001	-	1999
TOYOTA	HIGHLANDER	V-6, 3.5 L	2008	-	2009
CHEVROLET	SILVERADO	V-8, 6.0 L	2003	-	2000
MITSUBISHI	LANCER	4 CIL, 2.0 L	2004	-	2008
MITSUBISHI	LANCER	4 CIL, 2.4 L	2004	-	2004
CHEVROLET	SILVERADO	V-8, 6.6 L	2003	-	2000
AUDI	A6	V-6, 3.0 L	2004	-	2004
CHEVROLET	SILVERADO	V-8, 8.1 L	2003	-	2000
MITSUBISHI	MONTERO	V-6, 3.8 L	2004	-	2004
CHEVROLET	SUBURBAN	V-8, 5.3 L	2002	-	2000
CHEVROLET	SUBURBAN	V-8, 5.7 L	2003	-	2000
CHEVROLET	SUBURBAN	V-8, 6.0 L	2003	-	2000
MITSUBISHI	OUTLANDER	4 CIL, 2.4 L	2004	-	2004
CHEVROLET	SILVERADO	V-8, 5.3 L	2003	-	2000
MITSUBISHI	OUTLANDER	V-6, 3.0 L	2007	-	2008
MITSUBISHI	MONTERO SPORT	V-6, 3.5 L	2004	-	2004
CHEVROLET	SUBURBAN	V-8, 7.4 L	2003	-	2000
CHEVROLET	SUBURBAN	V-8, 8.1 L	2003	-	2000
SAAB	9 - 5	V-6, 3.0 L	2002	-	2002
TOYOTA	LAND CRUISER	V-8, 4.7 L	2007	-	2007
TOYOTA	TUNDRA	V-8, 5.7 L	2009	-	2010
CHEVROLET	CAVALIER	4 CIL, 2.4 L	1996	-	1996
TOYOTA	RAV 4	4 CIL, 2.4 L	2007	-	2008
TOYOTA	RAV 4	4 CIL, 2.5 L	2009	-	2010
TOYOTA	RAV 4	V-6, 3.5 L	2008	-	2010
TOYOTA	TUNDRA	V-8, 4.7 L	2008	-	2007
TOYOTA	YARIS	4 CIL, 1.5 L	2008	-	2005
TOYOTA	SIENNA	V-6, 3.5 L	2008	-	2010
SAAB	9 - 3	4 CIL, 2.0 L	2002	-	2002
SAAB	9 - 3	4 CIL, 2.3 L	2002	-	2001
CHEVROLET	SILVERADO	V-8, 4.8 L	2003	-	2000
MERCEDES BE	ML320	V-6, 3.2 L	2000	-	1999
SAAB	9 - 5	4 CIL, 2.3 L	2002	-	2002
CHEVROLET	SILVERADO	V-6, 4.3 L	2003	-	2000

31780

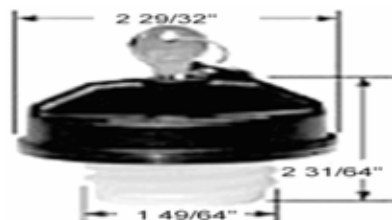

HONDA	CR-V	4 CIL, 2.0 L	2003	-	1999
HONDA	ACCORD	V-6, 3.0 L	2004	-	1999
HONDA	CR-V	4 CIL, 2.4 L	2004	-	2004
HONDA	ACCORD	4 CIL, 2.4 L	2004	-	2003
VOLVO	S60	5 CIL, 2.4 L	2001	-	2001
TOYOTA	FJ CRUISER	V-6, 4.0 L	2008	-	2007
TOYOTA	CAMRY	V-6, 3.0 L	2002	-	2001
SUZUKI	GRAND VITARA	V-6, 3.2 L	2009	-	2010
VOLVO	C70	5 CIL, 2.3 L	2004	-	2000
VOLVO	V40	4 CIL, 1.9 L	2001	-	2000

## Aplicación por Producto

**31780Y**



TOYOTA	TUNDRA	V-8, 5.7 L	2009 - 2010
--------	--------	------------	-------------

**31781**



VOLKSWAGEN	BEETLE	4 CIL, 2.0 L	2002 - 1999
AUDI	A8 QUATTRO	V-8, 4.2 L	2003 - 1999
VOLKSWAGEN	GLI	4 CIL, 2.0 L TURB2008	- 2007
VOLKSWAGEN	EUROVAN	5 CIL, 2.5 L	2001 - 2003
VOLKSWAGEN	GTI	4 CIL, 2.0 L TURB2008	- 2007
VOLKSWAGEN	BEETLE	4 CIL, 1.8 L	2002 - 1999
AUDI	TT	4 CIL, 1.8 L	2004 - 2000
AUDI	A4	V-6, 3.0 L	2002 - 2002
AUDI	A4	4 CIL, 1.8 L	2001 - 1998
AUDI	A6	V-6, 2.8 L	2001 - 1999
AUDI	A6	V-6, 2.7 L	2000 - 2000
VOLKSWAGEN	BORA	4 CIL, 1.9 L DIESE2007	- 2007
AUDI	A8	V-8, 4.2 L	2000 - 1999
AUDI	A4	V-6, 2.8 L	2000 - 1998
VOLKSWAGEN	JETTA	4 CIL, 1.9 L DIESE2005	- 2000
AUDI	A8	V-8, 3.7 L	2003 - 1999

**31782**



CHEVROLET	S-10	4 CIL, 2.2 L	2003 - 2002
CHEVROLET	CENTURY	V-6, 3.1 L	1998 - 1998
CHEVROLET	IMPALA	V-6, 3.4 L	2005 - 2000
PONTIAC	GRAND AM	V-6, 3.4 L	2004 - 1999
PONTIAC	GRAND PRIX	V-6, 3.1 L	2002 - 1998
CHEVROLET	CAVALIER	4 CIL, 2.4 L	1999 - 1997
CHEVROLET	MALIBU	V-6, 3.5 L	2003 - 2003

PONTIAC	SUNFIRE	4 CIL, 2.3 L	2004 - 1997
CHEVROLET	TRAILBLAZER	V-8, 5.3 L	2003 - 2003
CHEVROLET	IMPALA	V-6, 3.8 L	2005 - 2000
PONTIAC	GRAND PRIX	V-6, 3.8 L	2004 - 1998
CHEVROLET	MALIBU	4 CIL, 2.4 L	1998 - 1997
CHEVROLET	TRAILBLAZER	6 CIL, 4.2 L	2004 - 2002
PONTIAC	GRAND AM	V-6, 3.1 L	1998 - 1997
PONTIAC	GRAND AM	4 CIL, 2.2 L	2003 - 2002
CADILLAC	DEVILLE	V-8, 4.6 L	2004 - 1998
PONTIAC	GRAND AM	4 CIL, 2.4 L	2001 - 1998
PONTIAC	SUNFIRE	4 CIL, 2.2 L	2004 - 1997
CHEVROLET	BLAZER	V-6, 4.3 L	2004 - 1997
CADILLAC	EL DORADO	V-8, 4.6 L	2002 - 1999
CHEVROLET	CAVALIER	4 CIL, 2.2 L	2004 - 1997
CHEVROLET	EXPRESS	V-8, 5.3 L	2006 - 2005
CHEVROLET	VENTURE	V-6, 3.4 L	2000 - 2000
PONTIAC	SUNFIRE	4 CIL, 2.4 L	2002 - 1997
CHEVROLET	MALIBU	V-6, 3.1 L	2003 - 1997

**31783**



ACURA	RL	V-6, 3.5 L	2008 - 2008
ACURA	TSX	4 CIL, 2.4 L	2009 - 2009
ACURA	TL	V-6, 3.2 L	2008 - 2008
MERCURY	MYSTIQUE	V-6, 2.5 L	2000 - 1999
MERCURY	MYSTIQUE	4 CIL, 2.0 L	2000 - 1999
HONDA	CITY	4 CIL, 1.5 L	2010 - 2010
HONDA	ACCORD	4 CIL, 2.4 L	2007 - 2010
ACURA	TL	V-6, 3.7 L	2009 - 2009
VOLKSWAGEN	BEETLE	4 CIL, 2.0 L	2008 - 2007
ACURA	RL	V-6, 3.7 L	2009 - 2010
ACURA	TL	V-6, 3.5 L	2008 - 2009
HONDA	ACCORD	V-6, 3.5 L	2008 - 2010
ACURA	RDX	4 CIL, 2.3 L	2006 - 2010
FORD	CONTOUR	4 CIL, 2.0 L	2000 - 1999
FORD	CONTOUR	V-6, 2.5 L	2000 - 1999
HONDA	ODYSSEY	V-6, 3.5 L	2008 - 2010
HYUNDAI	ATTITUDE	4 CIL, 1.6 L	2008 - 2010
HONDA	FIT	4 CIL, 1.5 L	2009 - 2010
HONDA	PILOT	V-6, 3.5 L	2008 - 2010
HYUNDAI	ATTITUDE	4 CIL, 1.4 L	2008 - 2010
HONDA	CR-V	4 CIL, 2.4 L	2008 - 2009
HONDA	CIVIC	4 CIL, 1.8 L	2008 - 2010
HONDA	CIVIC HIBRIDO	4 CIL, 1.3 L	2008 - 2010
FORD	FOCUS	4 CIL, 2.0 L	2004 - 2004

## Aplicación por Producto

ACURA	MDX	V-6, 3.7 L	2008	-	2010
HONDA	RIDGELINE	V-6, 3.5 L	2008	-	2009

FORD	EXCURSION	V-8, 5.4 L	2002	-	2001
FORD	EXCURSION	V-10, 6.8 L	2005	-	2001
FORD	EXPLORER	V-8, 4.6 L	2002	-	2002
FORD	ESCAPE	V-6, 3.0 L	2002	-	2001
FORD	SUPER DUTY PICKUP	V-10, 6.8 L	2000	-	2000
FORD	EXPLORER	V-6, 4.0 L	2007	-	1999
FORD	EXPEDITION	V-8, 5.4 L	2002	-	1999
FORD	SUPER DUTY PICKUP	V-8, 5.4 L	2000	-	2000
FORD	EXPEDITION	V-8, 4.6 L	2002	-	1997
FORD	F SERIES PICKUP	V-8, 5.4 L	2001	-	2000
FORD	CROWN VICTORIA	V-8, 4.6 L	2004	-	1997
FORD	ESCORT	4 CIL, 2.0 L	2002	-	1998
FORD	SUPER DUTY VAN	V-10, 6.8 L	2002	-	2000
FORD	LOBO	V-8, 4.6 L	2007	-	2002
FORD	MUSTANG	V-6, 3.8 L	2001	-	1999
FORD	LOBO	V-8, 5.4 L	2007	-	2005
FORD	MUSTANG	V-8, 4.6 L	2004	-	1999
FORD	F-250	V-8, 4.6 L	2006	-	1998
FORD	F-150	V-6, 4.2 L	2006	-	1999
FORD	RANGER	4 CIL, 2.5 L	2001	-	1999
FORD	E SERIES VAN	V-8, 4.6 L	1999	-	1999
FORD	EXPLORER	V-8, 5.0 L	2001	-	1998
FORD	RANGER	4 CIL, 2.3 L	2003	-	2001
FORD	E SERIES VAN	V-8, 5.4 L	2003	-	2001
FORD	F SERIES PICKUP	V-8, 4.6 L	2001	-	2000
FORD	F SERIES PICKUP	V-6, 4.2 L	2001	-	2000
FORD	RANGER	V-6, 3.0 L	2002	-	1999
FORD	ESCAPE	4 CIL, 2.0 L	2002	-	2001
FORD	EXPLORER SPORT TRAC	V-6, 4.0 L	2006	-	2003
FORD	RANGER	V-6, 4.0 L	2001	-	1999
FORD	EXPLORER	V-8, 5.4 L	2000	-	1999
FORD	E SERIES VAN	V-6, 4.2 L	2003	-	2000
LINCOLN	AVIATOR	V-8, 4.6 L	2003	-	2005
MERCURY	SABLE	V-6, 3.0 L	2005	-	1997
FORD	SUPER DUTY VAN	V-6, 4.2 L	2003	-	2003
LINCOLN	LS	V-6, 3.0 L	2001	-	2000
FORD	SUPER DUTY VAN	V-8, 4.6 L	2003	-	2003
LINCOLN	CONTINENTAL	V-8, 4.6 L	2002	-	1997
LINCOLN	TOWN CAR	V-8, 4.6 L	2003	-	1998
FORD	SUPER DUTY VAN	V-8, 5.4 L	2000	-	2000
LINCOLN	LS	V-8, 3.9 L	2004	-	2000
LINCOLN	NAVIGATOR	V-8, 5.4 L	2004	-	2000
FORD	WINDSTAR	V-6, 3.0 L	1998	-	1998
FORD	WINDSTAR	V-6, 3.8 L	2002	-	1998

31828



MERCURY	GRAND MARQUIS	V-8, 4.6 L	2001	-	2000
FORD	RANGER	4 CIL, 2.3 L	2003	-	2001
FORD	EXPLORER	V-8, 4.6 L	2003	-	2002
FORD	SUPER DUTY PICKUP	V-8, 5.4 L	2000	-	2000
FORD	EXCURSION	V-10, 6.8 L	2004	-	2000
FORD	F SERIES PICKUP	V-8, 4.6 L	2001	-	2000
FORD	F SERIES PICKUP	V-6, 4.2 L	2001	-	2000
FORD	RANGER	V-6, 3.0 L	2002	-	1999
FORD	WINDSTAR	V-6, 3.8 L	2003	-	1999
FORD	ESCAPE	4 CIL, 2.0 L	2002	-	2001
FORD	RANGER	V-6, 4.0 L	2001	-	1999
FORD	SUPER DUTY PICKUP	V-10, 6.8 L	2000	-	2000
FORD	ESCAPE	V-6, 3.0 L	2004	-	2001
FORD	EXPLORER	V-8, 5.4 L	2000	-	1999
FORD	EXPLORER	V-8, 5.0 L	2001	-	1999
FORD	MUSTANG	V-6, 3.8 L	2000	-	1999
FORD	EXPEDITION	V-8, 5.4 L	2004	-	1999
FORD	CROWN VICTORIA	V-8, 4.6 L	2002	-	1999
FORD	ESCORT	4 CIL, 2.0 L	2002	-	1998
LINCOLN	MARK VIII	V-8, 4.6 L	1998	-	1996
LINCOLN	TOWN CAR	V-8, 4.6 L	2004	-	1996
MERCURY	SABLE	V-6, 3.0 L	2002	-	1996
LINCOLN	AVIATOR	V-8, 4.6 L	2003	-	2005
FORD	ZX2	4 CIL, 2.0 L	2002	-	2000
FORD	EXPEDITION	V-8, 4.6 L	2004	-	1999
FORD	EXCURSION	V-8, 5.4 L	2002	-	2000
FORD	F SERIES PICKUP	V-8, 5.4 L	2001	-	2000
FORD	MUSTANG	V-8, 4.6 L	2003	-	1999
LINCOLN	NAVIGATOR	V-8, 5.4 L	2001	-	1998
FORD	EXPLORER	V-6, 4.0 L	2003	-	1999
FORD	RANGER	4 CIL, 2.5 L	2001	-	1999

31830



## Aplicación por Producto

31831

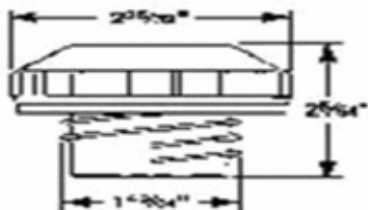

FORD	SUPER DUTY VAN	V-10, 6.8 L	2001 - 2001
FORD	EXPLORER	V-6, 4.0 L	1996 - 1996

31832

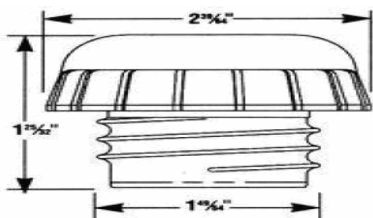

AUDI	A6	V-6, 3.0 L	2006 - 2004
CHEVROLET	SUBURBAN	V-8, 5.3 L	2004 - 2000
HONDA	CIVIC	4 CIL, 1.7 L	2005 - 2001
TOYOTA	COROLLA	4 CIL, 1.8 L	2004 - 2002
AUDI	ALLROAD QUATTRO	V-6, 2.7 L	2006 - 2004
CHEVROLET	SUBURBAN	V-8, 5.7 L	1999 - 1998
TOYOTA	RAV 4	4 CIL, 2.5 L	2009 - 2010
NISSAN	MAXIMA	V-6, 3.0 L	2001 - 2001
TOYOTA	CAMRY	V-6, 3.5 L	2008 - 2007
TOYOTA	CAMRY	4 CIL, 2.4 L	2008 - 2007
TOYOTA	RAV 4	V-6, 3.5 L	2008 - 2010
HONDA	CR-V	4 CIL, 2.0 L	2003 - 1999
TOYOTA	CAMRY	V-6, 3.0 L	2002 - 2001
HONDA	PILOT	V-6, 3.5 L	2007 - 2003
SUZUKI	GRAND VITARA	V-6, 3.2 L	2009 - 2010
HONDA	ODYSSEY	V-6, 3.5 L	2004 - 2003
VOLVO	S80	6 CIL, 2.9 L	2005 - 1999
CHEVROLET	SUBURBAN	V-8, 6.0 L	2002 - 2000
AUDI	A8 QUATTRO	V-8, 4.2 L	2004 - 2004
TOYOTA	CAMRY	4 CIL, 2.2 L	2002 - 2001
CHEVROLET	SUBURBAN	V-8, 8.1 L	2002 - 2002
VOLVO	V70	5 CIL, 2.3 L	2001 - 2000
MITSUBISHI	OUTLANDER	V-6, 3.0 L	2007 - 2008
VOLVO	S60	5 CIL, 2.3 L	2001 - 2001
VOLVO	S60	5 CIL, 2.4 L	2003 - 2001
MITSUBISHI	LANCER	4 CIL, 2.0 L	2006 - 2008
VOLVO	S40	4 CIL, 1.9 L	2004 - 2000
MITSUBISHI	LANCER	4 CIL, 2.4 L	2006 - 2004
TOYOTA	FJ CRUISER	V-6, 4.0 L	2008 - 2007
VOLVO	C70 T5	5 CIL, 2.3 L	2000 - 2000
TOYOTA	4 RUNNER	V-6, 3.4 L	2002 - 2002

TOYOTA	YARIS	4 CIL, 1.5 L	2008 - 2005
MITSUBISHI	MONTERO	V-6, 3.8 L	2007 - 2005
VOLVO	C70	5 CIL, 2.4 L	2004 - 2000
TOYOTA	RAV 4	4 CIL, 2.0 L	2003 - 2003
MITSUBISHI	OUTLANDER	4 CIL, 2.4 L	2006 - 2005
TOYOTA	RAV 4	4 CIL, 2.4 L	2006 - 2008
INFINITI	INFINITI Q45	V-8, 4.1 L	2001 - 2001
TOYOTA	HIGHLANDER	V-6, 3.5 L	2008 - 2009
VOLVO	S70	5 CIL, 2.3 L	2000 - 2000
INFINITI	INFINITI I30	V-6, 3.0 L	2001 - 2001
VOLVO	C70	5 CIL, 2.3 L	2004 - 2000
TOYOTA	LAND CRUISER	V-8, 4.7 L	2007 - 2003
HONDA	CR-V	4 CIL, 2.4 L	2004 - 2004
VOLVO	S70	5 CIL, 2.4 L	2000 - 1999
SUZUKI	GRAND VITARA	V-6, 2.7 L	2008 - 2006
TOYOTA	MATRIX	4 CIL, 1.8 L	2004 - 2003
VOLVO	S80	6 CIL, 2.8 L	2001 - 2000
VOLVO	S60	5 CIL, 2.5 L	2006 - 2004
TOYOTA	TUNDRA	V-8, 5.7 L	2009 - 2010
TOYOTA	SIENNA	V-6, 3.5 L	2008 - 2010
SUBARU	FORESTER	4 CIL, 2.5 L	2007 - 2006
CHEVROLET	SILVERADO	V-6, 4.3 L	2007 - 1999
HONDA	ACCORD	4 CIL, 2.4 L	2004 - 2003
HONDA	ACCORD	4 CIL, 2.3 L	2002 - 1999
TOYOTA	TUNDRA	V-8, 4.7 L	2008 - 2007
SUBARU	IMPREZA	4 CIL, 2.5 L	2007 - 2006
CHEVROLET	SILVERADO	V-8, 4.8 L	2007 - 2000
SAAB	9 - 5	4 CIL, 2.3 L	2002 - 2002
VOLVO	V70	5 CIL, 2.4 L	2001 - 1999
SAAB	9 - 3	4 CIL, 2.3 L	2002 - 2001
VOLVO	XC90	5 CIL, 2.5 L	2006 - 2003
SAAB	9 - 3	4 CIL, 2.0 L	2002 - 2002
CHEVROLET	CAVALIER	4 CIL, 2.4 L	1996 - 1996
PONTIAC	SUNFIRE	4 CIL, 2.4 L	1996 - 1996
CHEVROLET	C y K SERIES PICKUP	V-8, 8.1 L	2002 - 2001
CHEVROLET	C y K SERIES PICKUP	V-8, 7.4 L	2000 - 1999
CHEVROLET	AVALANCHE	V-8, 5.3 L	2003 - 2002
SAAB	9 - 5	V-6, 3.0 L	2002 - 2002
CHEVROLET	SILVERADO	V-8, 6.0 L	2007 - 2000
CHEVROLET	SILVERADO	V-8, 8.1 L	2003 - 2000
HONDA	CIVIC	4 CIL, 1.6 L	2000 - 1998
HONDA	ACCORD	V-6, 3.0 L	2007 - 1999
SUZUKI	SX4	4 CIL, 2.0 L	2008 - 2010
CHEVROLET	SILVERADO	V-8, 6.6 L	2003 - 2000
CHEVROLET	SILVERADO	V-8, 5.3 L	2003 - 2000

31832Y



TOYOTA	TUNDRA	V-8, 5.7 L	2009 - 2010
--------	--------	------------	-------------

31833

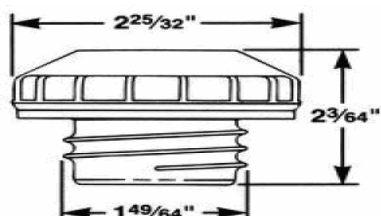

VOLKSWAGEN	BORA	4 CIL, 1.9 L DIESEL	2007 - 2007
VOLKSWAGEN	JETTA	4 CIL, 1.9 L DIESEL	2005 - 2000
AUDI	A4	V-6, 3.0 L	2003 - 2002
AUDI	A4	4 CIL, 1.8 L	2003 - 1998
AUDI	TT	4 CIL, 1.8 L	2006 - 2005
AUDI	ALLROAD QUATTRO	V-6, 2.7 L	2003 - 2002
AUDI	A8	V-8, 3.7 L	1999 - 1998
AUDI	A4	V-6, 2.8 L	1998 - 1998
AUDI	A6	V-6, 3.0 L	2003 - 2002
VOLKSWAGEN	BEETLE	4 CIL, 1.8 L	2003 - 1999
VOLKSWAGEN	GTI	V-6, 2.8 L	2001 - 1999
AUDI	A8	V-8, 4.2 L	2007 - 2001
VOLKSWAGEN	GLI	4 CIL, 2.0 L TURBO	2008 - 2007
VOLKSWAGEN	GTI	4 CIL, 2.0 L	2000 - 1999
VOLKSWAGEN	EUROVAN	5 CIL, 2.5 L	2001 - 2003
AUDI	A6	V-6, 2.8 L	1998 - 1998
VOLKSWAGEN	GTI	4 CIL, 2.0 L TURBO	2008 - 2007
VOLKSWAGEN	BEETLE	4 CIL, 2.0 L	2003 - 1998

31835



CHEVROLET	EXPRESS	V-8, 6.5 L	2000 - 2000
CHEVROLET	SILVERADO	V-8, 6.6 L	2001 - 2001

31836



DODGE	JOURNEY	V-6, 3.5 L	2009 - 2010
DODGE	CHARGER	V-8, 6.1 L	2008 - 2009
JEEP	GRAND CHEROKEE	V-8, 4.0 L	2001 - 2001
DODGE	RAM 4000	V-6, 5.9 L DIESEL	2008 - 2008
MITSUBISHI	ECLIPSE	V-6, 3.8 L	2007 - 2008
DODGE	RAM 4000	V-6, 6.7 L DIESEL	2008 - 2009
DODGE	DURANGO	V-6, 3.7 L	2005 - 2005
DODGE	RAM 2500	V-8, 4.7 L	2004 - 2009
JEEP	COMPASS	4 CIL, 2.4 L	2008 - 2010
DODGE	AVENGER	4 CIL, 2.0 L	2008 - 2009
DODGE	AVENGER	4 CIL, 2.4 L	2008 - 2009
DODGE	RAM 2500	V-8, 5.7 L	2008 - 2009
JEEP	GRAND CHEROKEE	6 CIL, 4.0 L	2002 - 2001
DODGE	NITRO	V-6, 4.0 L	2008 - 2010
DODGE	CALIBER	4 CIL, 2.4 L	2008 - 2009
DODGE	NITRO	V-6, 3.7 L	2008 - 2010
MAZDA	CX-9	V-6, 3.7 L	2008 - 2007
JEEP	GRAND CHEROKEE	V-6, 3.7 L	2008 - 2009
DODGE	CHARGER	V-6, 3.5 L	2008 - 2009
DODGE	RAM 1500	V-6, 3.7 L	2006 - 2009
MITSUBISHI	GALANT	4 CIL, 2.4 L	2004 - 2004
DODGE	CHARGER	V-8, 5.7 L	2008 - 2009
MITSUBISHI	GALANT	V-6, 3.8 L	2004 - 2004
CHRYSLER	TOWN & COUNTRY	V-6, 3.3 L	2002 - 2000
JEEP	GRAND CHEROKEE	V-8, 5.7 L	2008 - 2009
DODGE	STRATUS	4 CIL, 2.4 L	2004 - 2000
JEEP	PATRIOT	4 CIL, 2.4 L	2008 - 2010
MAZDA	MAZDA 6	V-6, 3.0 L	2008 - 2008
DODGE	CARAVAN	V-6, 3.8 L	2002 - 2002
DODGE	DURANGO	V-8, 5.2 L	2000 - 2000
DODGE	STRATUS	V-6, 3.0 L	2002 - 2001
DODGE	DURANGO	V-8, 5.7 L	2007 - 2009
DODGE	CARAVAN	4 CIL, 2.4 L	2002 - 2002
DODGE	DURANGO	V-8, 4.7 L	2006 - 2000
DODGE	CARAVAN	V-6, 3.0 L	2002 - 2002
DODGE	CARAVAN	V-6, 3.3 L	2004 - 2000
DODGE	CARAVAN	V-6, 3.3 L FLEX	2003 - 2001
CHRYSLER	VOYAGER	V-6, 3.3 L	2003 - 2000
DODGE	STRATUS	V-6, 2.5 L	2001 - 2000
DODGE	NEON	4 CIL, 2.0 L	2005 - 1999
JEEP	GRAND CHEROKEE	V-8, 4.7 L	2004 - 2001
JEEP	WRANGLER	V-6, 4.0 L	2004 - 2004
MITSUBISHI	ECLIPSE	V-6, 3.0 L	2004 - 2004

## Aplicación por Producto

DODGE	JOURNEY	4 CIL, 2.4 L	2009	-	2010
DODGE	INTREPID	V-6, 3.2 L	2001	-	2000
MAZDA	CX-7	4 CIL, 2.3 L	2008	-	2006
JEEP	GRAND CHEROKEE	V-8, 6.1 L	2008	-	2009
DODGE	INTREPID	V-6, 2.7 L	2003	-	2000
DODGE	NEON	4 CIL, 2.4 L	2005	-	2003
DODGE	DAKOTA	V-6, 3.7 L	2008	-	2009
DODGE	STRATUS	4 CIL, 2.0 L	2000	-	2000
JEEP	LIBERTY	V-6, 3.7 L	2008	-	2009
DODGE	DURANGO	V-8, 5.9 L	2003	-	2000
JEEP	WRANGLER	V-6, 3.8 L	2008	-	2009
DODGE	INTREPID	V-6, 3.5 L	2001	-	2000
NISSAN	FRONTIER	4 CIL, 2.4 L	2001	-	2001
NISSAN	ROGUE	4 CIL, 2.5 L	2008	-	2010
CHRYSLER	CONCORDE	V-6, 3.2 L	2001	-	2000
NISSAN	FRONTIER	V6, 4.0 L	2008	-	2008
CHRYSLER	300M	V-6, 3.5 L	2004	-	2000
NISSAN	QUEST	V-6, 3.5 L	2007	-	2009
CHRYSLER	PT CRUISER	4 CIL, 2.4 L	2004	-	2010
NISSAN	FRONTIER	V-6, 4.0 L	2007	-	2007
NISSAN	QUEST	V-6, 3.3 L	2001	-	2000
CHRYSLER	GRAND VOYAGER	V-6, 3.8 L	2000	-	2000
CHRYSLER	GRAND VOYAGER	V-6, 3.3 L	2000	-	2000
NISSAN	QUEST	6 CIL, 3.5 L	2004	-	2004
NISSAN	350Z	V-6, 3.5 L	2007	-	2009
CHRYSLER	300 C	V-6, 3.5 L	2007	-	2009
NISSAN	SENTRA	4 CIL, 1.8 L	2002	-	2001
NISSAN	PATHFINDER	V-6, 4.0 L	2007	-	2010
NISSAN	370Z	V-6, 3.7 L	2009	-	2009
NISSAN	ALTIMA	4 CIL, 2.4 L	2004	-	2002
NISSAN	ALTIMA	4 CIL, 2.5 L	2008	-	2010
CHRYSLER	300 C	V-8, 5.7 L	2007	-	2009
NISSAN	ALTIMA	V-6, 3.5 L	2008	-	2009
NISSAN	PATHFINDER	V-6, 3.5 L	2002	-	2001
NISSAN	MAXIMA	V-6, 3.5 L	2007	-	2008
CHRYSLER	CIRRUS	V-6, 2.5 L	2000	-	2000
CHRYSLER	CIRRUS	4 CIL, 2.4 L	2000	-	2000
NISSAN	MURANO	V-6, 3.5 L	2008	-	2010
CHRYSLER	CIRRUS	4 CIL, 2.0 L	2000	-	2000
CHRYSLER	CONCORDE	V-6, 3.5 L	2002	-	2002
JEEP	CHEROKEE	4 CIL, 2.5 L	1998	-	1997
JEEP	COMMANDER	V-8, 5.7 L	2008	-	2009
CHRYSLER	VOYAGER	V-6, 3.0 L	2001	-	2000
NISSAN	X-TRAIL	4 CIL, 2.5 L	2008	-	2008
CHRYSLER	TOWN & COUNTRY	V6, 4.0 L	2008	-	2010
NISSAN	ARMADA	V-8, 5.6 L	2006	-	2010
JEEP	CHEROKEE	6 CIL, 4.0 L	2001	-	1997
NISSAN	XTERRA	V-6, 4.0 L	2007	-	2007
NISSAN	FRONTIER	4 CIL, 2.5 L	2007	-	2007
NISSAN	TIIDA	4 CIL, 1.8 L	2008	-	2010
DODGE	STRATUS	V-6, 2.7 L	2002	-	2001
NISSAN	XTERRA	V-6, 3.3 L	2002	-	2001

NISSAN	FRONTIER	V-6, 3.3 L	2001	-	2001
NISSAN	SENTRA	4 CIL, 2.0 L	2008	-	2010
CHRYSLER	SEBRING	V-6, 2.5 L	2002	-	2000
MITSUBISHI	ENDEAVOR	V-6, 3.8 L	2004	-	2004
NISSAN	TITAN	V-8, 5.6 L	2008	-	2009
RENAULT	KOLEOS	4 CIL, 2.5 L	2009	-	2010
NISSAN	XTERRA	4 CIL, 2.4 L	2002	-	2001
NISSAN	SENTRA	4 CIL, 2.5 L	2008	-	2010
CHRYSLER	ASPEN	V-8, 5.7 L	2007	-	2009
CHRYSLER	TOWN & COUNTRY	V-6, 3.8 L	2004	-	2000

**31838**

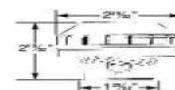

NISSAN	FRONTIER	4 CIL, 2.4 L	2004	-	2001
DODGE	DURANGO	V-8, 4.7 L	2006	-	2000
DODGE	DAKOTA	V-6, 3.7 L	2008	-	2009
SUBARU	OUTBACK	4 CIL, 2.5 L	2007	-	2006
NISSAN	FRONTIER	4 CIL, 2.5 L	2007	-	2005
MAZDA	CX-7	4 CIL, 2.3 L	2008	-	2006
DODGE	DURANGO	V-6, 3.7 L	2005	-	2004
NISSAN	FRONTIER	V-6, 3.3 L	2004	-	2001
NISSAN	MURANO	6 CIL, 3.5 L	2006	-	2004
NISSAN	FRONTIER	V-6, 4.0 L	2007	-	2005
MAZDA	CX-9	V-6, 3.7 L	2008	-	2007
MAZDA	MX-5 MIATA	4 CIL, 2.0 L	2007	-	2006
RENAULT	KOLEOS	4 CIL, 2.5 L	2009	-	2010
NISSAN	X-TRAIL	4 CIL, 2.5 L	2008	-	2008
DODGE	RAM 1500	V-6, 3.9 L	2001	-	2000
NISSAN	XTERRA	V-6, 4.0 L	2007	-	2005
DODGE	RAM 1500	V-6, 3.7 L	2005	-	2009
NISSAN	XTERRA	V-6, 3.3 L	2002	-	2001
DODGE	NITRO	V-6, 4.0 L	2008	-	2010
NISSAN	XTERRA	4 CIL, 2.4 L	2004	-	2001
DODGE	NITRO	V-6, 3.7 L	2008	-	2010
NISSAN	TITAN	V-8, 5.6 L	2008	-	2009
NISSAN	ROGUE	4 CIL, 2.5 L	2008	-	2010
NISSAN	PATHFINDER	V-6, 4.0 L	2007	-	2010
DODGE	JOURNEY	4 CIL, 2.4 L	2009	-	2010
NISSAN	MURANO	V-6, 3.5 L	2008	-	2010
NISSAN	QUEST	V-6, 3.5 L	2007	-	2009
DODGE	DURANGO	V-8, 5.9 L	2003	-	2000
NISSAN	QUEST	6 CIL, 3.5 L	2005	-	2005
DODGE	DURANGO	V-8, 5.7 L	2007	-	2009
NISSAN	PATHFINDER	V-6, 3.5 L	2004	-	2001
MAZDA	MAZDA 6	4 CIL, 2.3 L	2007	-	2006



## Aplicación por Producto

DODGE	DURANGO	V-8, 5.2 L	2000	-	2000
SUBARU	LEGACY	4 CIL, 2.5 L	2007	-	2006
SUBARU	B9 TRIBECA	6 CIL, 3.0 L	2007	-	2006
MAZDA	MAZDA 6	V-6, 3.0 L	2007	-	2008
DODGE	JOURNEY	V-6, 3.5 L	2009	-	2010
MITSUBISHI	GALANT	4 CIL, 2.4 L	2007	-	2004
CHRYSLER	GRAND VOYAGER	V-6, 3.3 L	2000	-	2000
CHRYSLER	GRAND VOYAGER	V-6, 3.8 L	2000	-	2000
MITSUBISHI	ECLIPSE	V-6, 3.0 L	2005	-	2005
DODGE	INTREPID	V-6, 2.7 L	2003	-	2000
CHRYSLER	PT CRUISER	4 CIL, 2.4 L	2007	-	2010
NISSAN	350Z	V-6, 3.5 L	2006	-	2009
MITSUBISHI	ECLIPSE	V-6, 3.8 L	2007	-	2008
MITSUBISHI	ENDEAVOR	V-6, 3.8 L	2007	-	2005
CHRYSLER	SEBRING	4 CIL, 2.4 L	2006	-	2004
DODGE	CHARGER	V-8, 6.1 L	2008	-	2009
CHRYSLER	SEBRING	V-6, 3.0 L	2006	-	2004
CHRYSLER	300 C	V-6, 3.5 L	2006	-	2009
CHRYSLER	ASPEN	V-8, 5.7 L	2007	-	2009
DODGE	INTREPID	V-6, 3.2 L	2001	-	1998
DODGE	CHARGER	V-6, 3.5 L	2008	-	2009
CHRYSLER	PACIFICA	V-6, 3.5 L	2006	-	2004
CHRYSLER	PACIFICA	V-6, 3.8 L	2006	-	2006
DODGE	CALIBER	4 CIL, 2.4 L	2008	-	2009
DODGE	RAM 2500	V-8, 4.7 L	2004	-	2009
CHRYSLER	TOWN & COUNTRY	V-6, 3.8 L	2007	-	2000
DODGE	AVENGER	4 CIL, 2.4 L	2008	-	2009
MITSUBISHI	GALANT	V-6, 3.8 L	2007	-	2004
DODGE	AVENGER	4 CIL, 2.0 L	2008	-	2009
CHRYSLER	TOWN & COUNTRY	V6, 4.0 L	2008	-	2010
CHRYSLER	VOYAGER	V-6, 3.3 L	2007	-	2000
DODGE	CHARGER	V-8, 5.7 L	2008	-	2009
CHRYSLER	300 C	V-8, 5.7 L	2006	-	2009
NISSAN	TIIDA	4 CIL, 1.8 L	2008	-	2010
DODGE	CARAVAN	V-6, 3.3 L FLEX	2003	-	2001
NISSAN	SENTRA	4 CIL, 2.5 L	2006	-	2010
DODGE	CARAVAN	V-6, 3.3 L	2007	-	2004
NISSAN	SENTRA	4 CIL, 2.0 L	2008	-	2010
NISSAN	SENTRA	4 CIL, 1.8 L	2003	-	2001
DODGE	STRATUS	V-6, 3.0 L	2002	-	2001
CHRYSLER	TOWN & COUNTRY	V-6, 3.3 L	2003	-	2000
CHRYSLER	300M	V-6, 3.5 L	2002	-	2002
CHRYSLER	VOYAGER	V-6, 3.0 L	2001	-	2000
NISSAN	MAXIMA	V-6, 3.5 L	2007	-	2008
CHRYSLER	CONCORDE	V-6, 3.5 L	2002	-	2002
DODGE	STRATUS	V-6, 2.5 L	2001	-	2000
CHRYSLER	CONCORDE	V-6, 3.2 L	2001	-	2000
DODGE	STRATUS	4 CIL, 2.4 L	2006	-	2000
CHRYSLER	300 C	V-8, 6.1 L	2006	-	2005
CHRYSLER	CIRRUS	4 CIL, 2.0 L	2000	-	2000
DODGE	STRATUS	4 CIL, 2.0 L	2006	-	2000
NISSAN	ALTIMA	V-6, 3.5 L	2008	-	2009

DODGE	NEON	4 CIL, 2.4 L	2006	-	2003
CHRYSLER	CONCORDE	V-6, 2.7 L	2000	-	2000
DODGE	NEON	4 CIL, 2.0 L	2006	-	1999
NISSAN	ALTIMA	4 CIL, 2.5 L	2008	-	2010
NISSAN	370Z	V-6, 3.7 L	2009	-	2009
DODGE	INTREPID	V-6, 3.5 L	2002	-	2000
NISSAN	ARMADA	V-8, 5.6 L	2006	-	2010
DODGE	STRATUS	V-6, 2.7 L	2002	-	2001
JEEP	GRAND CHEROKEE	V-8, 6.1 L	2007	-	2009
JEEP	GRAND CHEROKEE	V-6, 4.0 L	2004	-	2003
DODGE	RAM 4000	V-6, 6.7 L DIESEL	2008	-	2009
JEEP	COMPASS	4 CIL, 2.4 L	2008	-	2010
JEEP	LIBERTY	V-6, 3.7 L	2007	-	2009
DODGE	RAM SERIES PICKUP	V-8, 4.7L	2003	-	2002
JEEP	GRAND CHEROKEE	V-8, 4.0 L	2001	-	2001
JEEP	COMMANDER	V-8, 5.7 L	2008	-	2009
DODGE	RAM MAXI VAN 1500	V-6, 3.9 L	2002	-	2002
DODGE	RAM 4000	V-6, 5.9 L DIESEL	2007	-	2008
JEEP	WRANGLER	V-6, 3.8 L	2007	-	2009
JEEP	WRANGLER	6 CIL, 4.0 L	2006	-	2001
DODGE	RAM MAXI VAN 3500	V-8, 5.9 L	2002	-	2002
DODGE	RAM MAXI WAGON 3500	V-8, 5.9 L	2002	-	2002
JEEP	GRAND CHEROKEE	V-8, 4.7 L	2007	-	2001
JEEP	CHEROKEE	6 CIL, 4.0 L	2001	-	1997
JEEP	CHEROKEE	4 CIL, 2.5 L	1998	-	1997
JEEP	GRAND CHEROKEE	V-8, 5.7 L	2007	-	2009
DODGE	RAM SERIES PICKUP	V-6, 3.7 L	2003	-	2002
DODGE	RAM WAGON 3500	V-8, 5.2 L	2000	-	2000
INFINITI	Q45	V-8, 4.5 L	2003	-	2002
DODGE	RAM 3500	V-8, 5.7 L	2007	-	2003
DODGE	RAM 2500	V-8, 5.9 L	2002	-	2002
JEEP	GRAND CHEROKEE	V-6, 3.7 L	2008	-	2009
JEEP	GRAND CHEROKEE	6 CIL, 4.0 L	2002	-	2000
INFINITI	INFINITI Q45	V-8, 4.5 L	2003	-	2002
JEEP	WRANGLER	4 CIL, 2.4 L	2006	-	2003
JEEP	PATRIOT	4 CIL, 2.4 L	2008	-	2010
DODGE	RAM 2500	V-8, 4.7L	2003	-	2002
JEEP	WRANGLER	4 CIL, 2.5 L	2002	-	2002
DODGE	RAM 2500	V-8, 5.7 L	2008	-	2009

31838Y



NISSAN	ARMADA	V-8, 5.6 L	2006	-	2010
NISSAN	TITAN	V-8, 5.6 L	2009	-	2009

## Aplicación por Producto

### 31839



TOYOTA	SIENNA	V-6, 3.3 L	2006	-	2004
TOYOTA	4 RUNNER	V-8, 4.7 L	2006	-	2004
TOYOTA	TACOMA	V-6, 4.0 L	2008	-	2006
TOYOTA	COROLLA	4 CIL, 1.8 L	2008	-	2005
TOYOTA	CAMRY	V-6, 3.0 L	2006	-	2003
TOYOTA	SIENNA	V-6, 3.0 L	2003	-	2003
TOYOTA	MATRIX	4 CIL, 1.8 L	2008	-	2007
TOYOTA	CAMRY	4 CIL, 2.4 L	2006	-	2003
TOYOTA	SOLARA	V-6, 3.3 L	2006	-	2005
TOYOTA	SEQUOIA	V-8, 4.7 L	2008	-	2007

### 31840



TOYOTA	COROLLA	4 CIL, 1.8 L	2008	-	2007
TOYOTA	TACOMA	V-6, 4.0 L	2008	-	2006
TOYOTA	SEQUOIA	V-8, 4.7 L	2008	-	2007
TOYOTA	4 RUNNER	V-8, 4.7 L	2003	-	2003
TOYOTA	MATRIX	4 CIL, 1.8 L	2008	-	2005

### 31841



FORD	FIVE HUNDRED	V-6, 3.0 L	2007	-	2005
FORD	FREESTAR	V-6, 3.9 L	2006	-	2005
MERCURY	GRAND MARQUIS	V-8, 4.6 L	2005	-	2005
FORD	EXPLORER	V-6, 4.0 L	2007	-	2009
FORD	FOCUS	4 CIL, 2.0 L	2007	-	2010
FORD	LOBO	V-8, 5.4 L	2004	-	2010
FORD	MUSTANG	V-8, 4.6 L	2007	-	2009
FORD	FUSION	4 CIL, 2.3 L	2008	-	2007
FORD	FUSION	V-6, 3.0 L	2008	-	2009

FORD	FREESTAR	V-6, 4.2 L	2006	-	2004
MERCURY	MARINER	V-6, 3.0 L	2007	-	2009
MERCURY	MILAN	V-6, 3.0 L	2007	-	2009
FORD	LOBO	V-8, 4.6 L	2004	-	2010
FORD	RANGER	4 CIL, 2.3 L	2007	-	2010
FORD	EXPLORER	V-8, 4.6 L	2007	-	2009
FORD	EXPLORER SPORT TRAC	V-8, 4.6 L	2007	-	2009
MERCURY	MARINER	4 CIL, 2.3 L	2007	-	2005
FORD	E SERIES VAN	V-8, 4.6 L	2006	-	2010
FORD	MUSTANG	V-6, 4.0 L	2007	-	2010
LINCOLN	NAVIGATOR	V-8, 5.4 L	2007	-	2009
FORD	E SERIES VAN	V-8, 5.4 L	2007	-	2010
LINCOLN	LS	V-8, 3.9 L	2006	-	2005
FORD	EDGE	V-6, 3.5 L	2007	-	2010
LINCOLN	TOWN CAR	V-8, 4.6 L	2006	-	2005
FORD	F-450 SUPER DUTY	V-10, 6.8 L	2007	-	2010
FORD	F-150	V-8, 4.6 L	2009	-	2010
FORD	EXPLORER SPORT TRAC	V-6, 4.0 L	2007	-	2009
FORD	F-350 SUPER DUTY	V-8, 5.4 L	2007	-	2009
LINCOLN	MARK LT	V-8, 5.4 L	2008	-	2007
FORD	ESCAPE	4 CIL, 2.3 L	2007	-	2005
FORD	ESCAPE	V-6, 3.0 L	2008	-	2009
FORD	F-550 SUPER DUTY	V-10, 6.8 L	2008	-	2010
FORD	EXPEDITION	V-8, 5.4 L	2005	-	2009
LINCOLN	MKX	V-6, 3.5 L	2008	-	2007

### 31842



MERCURY	MARINER	V-6, 3.0 L	2007	-	2009
FORD	RANGER	4 CIL, 2.3 L	2004	-	2010
FORD	F-350 SUPER DUTY	V-8, 5.4 L	2007	-	2009
MERCURY	MILAN	V-6, 3.0 L	2007	-	2009
FORD	FUSION	4 CIL, 2.3 L	2008	-	2007
FORD	LOBO	V-8, 5.4 L	2009	-	2010
FORD	EDGE	V-6, 3.5 L	2007	-	2010
FORD	FOCUS	4 CIL, 2.0 L	2007	-	2010
FORD	EXPLORER	V-8, 4.6 L	2007	-	2009
LINCOLN	MKX	V-6, 3.5 L	2008	-	2007
LINCOLN	NAVIGATOR	V-8, 5.4 L	2008	-	2009
FORD	F-450 SUPER DUTY	V-10, 6.8 L	2007	-	2010
FORD	E SERIES VAN	V-8, 5.4 L	2006	-	2010
LINCOLN	MARK LT	V-8, 5.4 L	2008	-	2007
FORD	FUSION	V-6, 3.0 L	2008	-	2009
FORD	ESCAPE	V-6, 3.0 L	2007	-	2009
FORD	EXPLORER	V-6, 4.0 L	2007	-	2009

## Aplicación por Producto

FORD	EXPLORER SPORT TRAC	V-6, 4.0 L	2007	-	2009
FORD	EXPLORER SPORT TRAC	V-8, 4.6 L	2007	-	2009
FORD	MUSTANG	V-6, 4.0 L	2008	-	2010
FORD	EXPEDITION	V-8, 5.4 L	2005	-	2009
FORD	F-150	V-8, 4.6 L	2009	-	2010
FORD	F-550 SUPER DUTY	V-10, 6.8 L	2008	-	2010
FORD	FREESTAR	V-6, 4.2 L	2007	-	2004
FORD	FREESTAR	V-6, 3.9 L	2007	-	2004
FORD	MUSTANG	V-8, 4.6 L	2008	-	2009
FORD	E SERIES VAN	V-8, 4.6 L	2008	-	2010
MERCURY	MARINER	4 CIL, 2.3 L	2007	-	2005
FORD	LOBO	V-8, 4.6 L	2009	-	2010

CHEVROLET	TAHOE	V-8, 4.8 L	2007	-	2006
HUMMER	H3	5 CIL, 3.7 L	2008	-	2010
CHEVROLET	TAHOE	V-8, 5.3 L	2007	-	2010
HUMMER	H2	V-8, 6.2 L	2008	-	2010
PONTIAC	G6	V-6, 3.9 L	2006	-	2006
CHEVROLET	UPLANDER	V-6, 3.9 L	2006	-	2009
CHEVROLET	UPLANDER	V-6, 3.5 L	2007	-	2005
CHEVROLET	MALIBU	V-6, 3.5 L	2007	-	2004
CHEVROLET	TRAVERSE	V-6, 3.6 L	2010	-	2011
PONTIAC	G6	V-6, 3.5 L	2008	-	2006
CADILLAC	ESCALADE	V-8, 5.3 L	2004	-	2002
CADILLAC	ESCALADE	V-8, 6.0 L	2006	-	2002
CHEVROLET	TRAILBLAZER	6 CIL, 4.2 L	2007	-	2005
PONTIAC	G6	V-6, 3.6 L	2008	-	2007
CADILLAC	ESCALADE	V-8, 5.7 L	2000	-	1999
PONTIAC	G5	4 CIL, 2.4 L	2008	-	2007
BUICK	ENCLAVE	V-6, 3.6 L	2010	-	2010
CHEVROLET	HHR	4 CIL, 2.4 L	2008	-	2006
PONTIAC	G3	4 CIL, 1.6 L	2008	-	2006
CHEVROLET	SONORA	V-8, 5.3 L	2003	-	2003
CHEVROLET	SILVERADO	V-8, 4.8 L	2008	-	2010
CHEVROLET	SILVERADO	V-8, 5.3 L	2008	-	2010
CHEVROLET	CAPTIVA	4 CIL, 2.4 L	2009	-	2010
CHEVROLET	CAPTIVA	4 CIL, 2.4 L	2008	-	2008
PONTIAC	G4	4 CIL, 2.2 L	2006	-	2006
CHEVROLET	SILVERADO	V-6, 4.3 L	2008	-	2010
CHEVROLET	AVALANCHE	V-8, 5.3 L	2007	-	2010
CHEVROLET	CAPTIVA	V-6, 3.6 L	2008	-	2008
CHEVROLET	MALIBU	V-6, 3.6 L	2008	-	2010
CHEVROLET	MALIBU	4 CIL, 2.2 L	2007	-	2004
CHEVROLET	ASTRA	4 CIL, 1.8 L	2007	-	2009
PONTIAC	G4	4 CIL, 2.4 L	2006	-	2006

**31843**



SAAB	9 - 5	4 CIL, 2.3 L	2007	-	2004
PONTIAC	TORRENT	V-6, 3.4 L	2008	-	2006
CHEVROLET	COLORADO	4 CIL, 2.8 L	2006	-	2005
GMC	ACADIA	V-6, 3.6 L	2008	-	2010
CHEVROLET	EQUINOX	V-6, 3.4 L	2007	-	2005
PONTIAC	GRAND PRIX	V-6, 3.8 L	2005	-	2005
CHEVROLET	COLORADO	5 CIL, 3.7 L	2007	-	2010
GMC	CANYON	5 CIL, 3.7 L	2008	-	2010
PONTIAC	MONTANA	V-6, 3.5 L	2006	-	2006
CHEVROLET	AVEO	4 CIL, 1.6 L	2008	-	2008
GMC	YUKON	V-8, 6.2 L	2009	-	2010
GMC	SIERRA	V-8, 6.2 L	2009	-	2010
CHEVROLET	EXPRESS	V-8, 5.3 L	2008	-	2010
CHEVROLET	COLORADO	4 CIL, 2.9 L	2007	-	2010
CHEVROLET	COLORADO	5 CIL, 3.5 L	2006	-	2004
CHEVROLET	EXPRESS CARGO VAN	V-6, 4.3 L	2008	-	2010
GMC	YUKON	V-8, 5.3 L	2008	-	2007
CHEVROLET	EXPRESS	V-8, 6.0 L	2008	-	2010
CHEVROLET	AVEO	4 CIL, 1.6 L	2009	-	2009
GMC	SIERRA	V-8, 5.3 L	2009	-	2010
CADILLAC	ESCALADE	V-8 6.2 L	2008	-	2010
PONTIAC	G5	4 CIL, 2.2 L	2008	-	2007
CHEVROLET	SUBURBAN	V-8, 5.3 L	2007	-	2010
HUMMER	H3	5 CIL, 3.5 L	2007	-	2006
HUMMER	H2	V-8, 6.0 L	2007	-	2006
PONTIAC	SOLSTICE	4 CIL, 2.4 L	2008	-	2006
CHEVROLET	SUBURBAN	V-8, 6.0 L	2008	-	2003
SUZUKI	XL-7	V-6, 3.6 L	2008	-	2009
CHEVROLET	OPTRA	4 CIL, 2.0 L	2006	-	2010
CADILLAC	ESCALADE	V-8, 6.2 L	2007	-	2007

**31844**



CHEVROLET	UPLANDER	V-6, 3.9 L	2006	-	2009
CHEVROLET	TRAVERSE	V-6, 3.6 L	2010	-	2011
CHEVROLET	SILVERADO	V-6, 4.3 L	2008	-	2010
CADILLAC	ESCALADE	V-8 6.2 L	2008	-	2010
GMC	SIERRA	V-8, 6.2 L	2009	-	2010
CADILLAC	ESCALADE	V-8, 5.3 L	2002	-	2002
CHEVROLET	AVEO	4 CIL, 1.6 L	2008	-	2008
CHEVROLET	TAHOE	V-8, 5.3 L	2008	-	2010
SUZUKI	XL-7	V-6, 3.6 L	2008	-	2009
GMC	YUKON	V-8, 5.3 L	2008	-	2007

## Aplicación por Producto

HUMMER	H3	5 CIL, 3.7 L	2008	-	2010
CHEVROLET	SUBURBAN	V-8, 5.3 L	2008	-	2010
CHEVROLET	ASTRA	4 CIL, 1.8 L	2007	-	2009
BUICK	ENCLAVE	V-6, 3.6 L	2010	-	2010
SAAB	9 - 5	4 CIL, 2.3 L	2007	-	2004
CHEVROLET	EXPRESS	V-8, 6.0 L	2008	-	2010
CHEVROLET	SILVERADO	V-8, 5.3 L	2008	-	2010
GMC	YUKON	V-8, 6.2 L	2009	-	2010
CHEVROLET	EXPRESS CARGO VAN	V-6, 4.3 L	2008	-	2010
CHEVROLET	AVEO	4 CIL, 1.6 L	2009	-	2009
CHEVROLET	TAHOE	V-8, 4.8 L	2007	-	2006
CADILLAC	ESCALADE	V-8, 6.0 L	2002	-	2002
CHEVROLET	SILVERADO	V-8, 4.8 L	2008	-	2010
HUMMER	H2	V-8, 6.2 L	2008	-	2010
CHEVROLET	SUBURBAN	V-8, 6.0 L	2008	-	2003
GMC	CANYON	5 CIL, 3.7 L	2008	-	2010
PONTIAC	MONTANA	V-6, 3.5 L	2006	-	2006
CHEVROLET	COLORADO	4 CIL, 2.9 L	2008	-	2010
CHEVROLET	CAPTIVA	V-6, 3.6 L	2008	-	2008
GMC	ACADIA	V-6, 3.6 L	2008	-	2010
PONTIAC	TORRENT	V-6, 3.4 L	2008	-	2006
CHEVROLET	CAPTIVA	4 CIL, 2.4 L	2009	-	2010
CHEVROLET	CAPTIVA	4 CIL, 2.4 L	2008	-	2008
PONTIAC	SOLSTICE	4 CIL, 2.4 L	2008	-	2006
CHEVROLET	AVALANCHE	V-8, 5.3 L	2008	-	2010
CHEVROLET	COLORADO	5 CIL, 3.7 L	2008	-	2010
PONTIAC	G4	4 CIL, 2.2 L	2006	-	2006
PONTIAC	G4	4 CIL, 2.4 L	2006	-	2006
CHEVROLET	EXPRESS	V-8, 5.3 L	2008	-	2010
PONTIAC	G5	4 CIL, 2.2 L	2008	-	2007
PONTIAC	G6	V-6, 3.9 L	2006	-	2006
CHEVROLET	OPTRA	4 CIL, 2.0 L	2006	-	2010
GMC	SIERRA	V-8, 5.3 L	2009	-	2010
PONTIAC	G5	4 CIL, 2.4 L	2008	-	2007
PONTIAC	G6	V-6, 3.6 L	2008	-	2007
PONTIAC	G6	V-6, 3.5 L	2008	-	2006
CHEVROLET	MALIBU	V-6, 3.6 L	2008	-	2010
PONTIAC	G3	4 CIL, 1.6 L	2008	-	2006

### 31847



BMW	328IS	V-6, 2.8 L	1999	-	1998
BMW	318TI	4 CIL, 1.9 L	1999	-	1998
MERCEDES BE	CLK55	V-8, 5.5 L	2006	-	2001
BMW	323IS	V-6, 2.5 L	1999	-	1998
BMW	740IL	V-8, 4.4 L	2001	-	1998
BMW	328I	V-6, 2.8 L	1998	-	1998
BMW	540I	V-8, 4.4 L	1998	-	1998
BMW	528I	V-6, 2.8 L	1999	-	1998
BMW	318I	4 CIL, 1.9 L	1998	-	1998
BMW	740I	V-8, 4.4 L	2001	-	1998

### 31848



BMW	645CI	V-8, 4.4 L	2005	-	2005
BMW	330CI	V-6, 3.0 L	2006	-	2004
BMW	545I	V-8, 4.4 L	2005	-	2004
BMW	745I	V-8, 4.4 L	2005	-	2005
BMW	325CI	V-6, 2.5 L	2006	-	2001
BMW	330CI	6 CIL, 3.0 L	2003	-	2001
BMW	X5	V-6, 3.0 L	2007	-	2009
BMW	540I	V-8, 4.4 L	2001	-	2000
BMW	330XI	6 CIL, 3.0 L	2006	-	2001
BMW	323CI	V-6, 2.5 L	2000	-	2000
BMW	328I	V-6, 2.8 L	2000	-	2000
BMW	530I	6 CIL, 3.0 L	2002	-	2002
BMW	528I	V-6, 2.8 L	2000	-	2000
MINI	COOPER	4 CIL, 1.6 L	2006	-	2005
BMW	745LI	V-8, 4.4 L	2005	-	2005
BMW	323I	V-6, 2.5 L	2000	-	1999

### 31846



HYUNDAI	ATTITUDE	4 CIL, 1.6 L	2008	-	2010
HYUNDAI	ATTITUDE	4 CIL, 1.4 L	2008	-	2010

31850



PONTIAC	FIREBIRD TRANS AM	V-8, 5.7 L	1998 - 1998
CHEVROLET	CAMARO Z28	V-6, 3.8 L	1998 - 1998

31852



SAAB	9 - 3	V-6, 2.8 L	2007 - 2006
CHEVROLET	EXPRESS	V-8, 6.0 L	2007 - 2004

31855



CADILLAC	SRX	V-6, 3.6 L	2006 - 2004
SAAB	9 - 3	V-6, 2.8 L	2007 - 2006

31856



MAZDA	MAZDA 6	4 CIL, 2.3 L	2008 - 2008
MAZDA	MAZDA 3	4 CIL, 2.0 L	2008 - 2009
MAZDA	MAZDA 3	4 CIL, 2.3 L	2008 - 2008

31857



MAZDA	MAZDA 6	4 CIL, 2.3 L	2008 - 2008
MAZDA	MAZDA 3	4 CIL, 2.0 L	2008 - 2009
MAZDA	MAZDA 3	4 CIL, 2.3 L	2008 - 2006
MAZDA	MAZDA 5	4 CIL, 2.3 L	2007 - 2006

38143



CHEVROLET	CAPTIVA	V-6, 3.6 L	2009 - 2010
-----------	---------	------------	-------------

38144



CHEVROLET	CAPTIVA	V-6, 3.6 L	2009 - 2010
-----------	---------	------------	-------------

### Tapones de Radiador

31295



MAZDA	MAZDA 3	4 CIL, 2.3 L	2008 - 2008
MAZDA	MAZDA 3	4 CIL, 2.0 L	2008 - 2008

31328

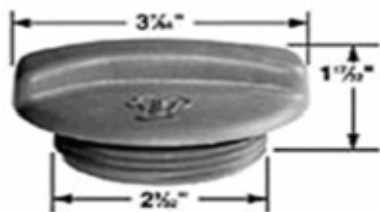

VOLKSWAGEN	GTI	V-6, 2.8 L	1999	-	1999
------------	-----	------------	------	---	------

31329

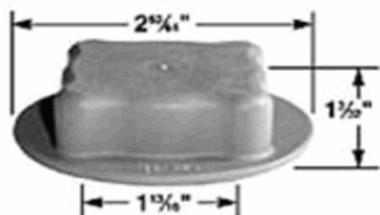

VOLVO	XC90	5 CIL, 2.5 L	2006	-	2003
VOLVO	S70	5 CIL, 2.4 L	2000	-	1999
VOLVO	S60	5 CIL, 2.3 L	2001	-	2001
VOLVO	S80	6 CIL, 2.8 L	2001	-	2000
VOLVO	S40	4 CIL, 1.9 L	2004	-	2000
VOLVO	S70	5 CIL, 2.3 L	2000	-	2000
VOLVO	V70	5 CIL, 2.4 L	2001	-	1999
VOLVO	S60	5 CIL, 2.5 L	2006	-	2004
VOLVO	C70	5 CIL, 2.4 L	2004	-	1999
VOLVO	V70	5 CIL, 2.3 L	2001	-	2000
VOLVO	S80	6 CIL, 2.9 L	2005	-	1999
VOLVO	XC90	6 CIL, 3.2 L	2007	-	2010
VOLVO	S60	5 CIL, 2.4 L	2003	-	2001
VOLVO	C70 T5	5 CIL, 2.3 L	2000	-	2000
VOLVO	C70	5 CIL, 2.3 L	2004	-	1999

31331



LAND ROVER	RANGE ROVER	V-8, 4.0 L	1999	-	1999
LAND ROVER	RANGE ROVER	V-8, 4.6 L	2000	-	1999
LAND ROVER	DISCOVERY	V-8, 4.0 L	2000	-	2004
LAND ROVER	DISCOVERY SERIES II	V-8, 4.0 L	2000	-	1999

31332

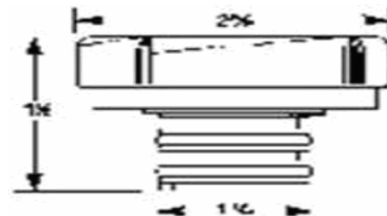

BMW	X5	V-6, 3.0 L	2002	-	2001
BMW	740I	V-8, 4.4 L	2001	-	1998
BMW	330CI	6 CIL, 3.0 L	2001	-	2001
BMW	X5	V-8, 4.4 L	2004	-	2004
BMW	Z4	6 CIL, 2.5 L	2003	-	2003
BMW	Z3	V-6, 3.0 L	2001	-	2001
BMW	745LI	V-8, 4.4 L	2005	-	2005
BMW	328IS	V-6, 2.8 L	1999	-	1998
BMW	323CI	V-6, 2.5 L	2000	-	2000
BMW	330CI	V-6, 3.0 L	2006	-	2004
BMW	750IL	V-12, 5.4 L	2001	-	1998
BMW	740IL	V-8, 4.4 L	2001	-	1998
BMW	760I	V-12, 6.0 L	2005	-	2005
BMW	Z3	V-6, 2.8 L	2000	-	1999
BMW	325XI	6 CIL, 2.5 L	2005	-	2005
BMW	323I	V-6, 2.5 L	2000	-	1999
BMW	M3	V-6, 3.2 L	2006	-	1999
BMW	325I	V-6, 2.5 L	2005	-	2001
BMW	X5	6 CIL, 3.0 L	2006	-	2000
BMW	323IS	V-6, 2.5 L	1999	-	1998
BMW	325CI	V-6, 2.5 L	2006	-	2001
BMW	760LI	V-12, 6.0 L	2005	-	2004
BMW	328I	V-6, 2.8 L	2000	-	1998
BMW	X5	V-8, 4.4 L	2000	-	2000
BMW	530I	6 CIL, 3.0 L	2002	-	2002
BMW	X5	V-6, 3.0 L	2004	-	2004
BMW	M5	V-8, 5.0 L	2003	-	2000
LAND ROVER	RANGE ROVER	V-8, 4.4 L	2005	-	2005
BMW	540I	V-8, 4.4 L	2001	-	1998
BMW	528I	V-6, 2.8 L	2000	-	1998
BMW	X3	V-6, 3.0 L	2007	-	2008
BMW	Z3	V-6, 2.5 L	2001	-	1999
BMW	X3	6 CIL, 3.0 L	2006	-	2005
BMW	745I	V-8, 4.4 L	2005	-	2003
BMW	525I	6 CIL, 2.5 L	2005	-	2001
BMW	Z4	V-6, 3.0 L	2004	-	2004
BMW	545I	V-8, 4.4 L	2004	-	2004
BMW	Z4	6 CIL, 3.0 L	2003	-	2003
BMW	330XI	6 CIL, 3.0 L	2006	-	2001
BMW	318TI	4 CIL, 1.9 L	1999	-	1998
BMW	Z4	V-6, 2.5 L	2006	-	2004
BMW	318I	4 CIL, 1.9 L	1998	-	1998



## Aplicación por Producto

31333



NISSAN	MURANO	6 CIL, 3.5 L	2006	-	2004
NISSAN	PATHFINDER	V-6, 3.3 L	2000	-	1998
NISSAN	TIIDA	4 CIL, 1.8 L	2008	-	2010
NISSAN	TSURU	4 CIL, 1.6 L	2009	-	2010
NISSAN	URVAN	4 CIL, 2.5 L	2009	-	2010
NISSAN	QUEST	6 CIL, 3.3 L	2002	-	2002
NISSAN	XTERRA	V-6, 3.3 L	2002	-	2000
NISSAN	QUEST	V-6, 3.0 L	1998	-	1997
NISSAN	FRONTIER	4 CIL, 2.4 L	2004	-	1999
NISSAN	QUEST	V-6, 3.5 L	2007	-	2007
NISSAN	URVAN	4 CIL, 3.0 L DIESE	2009	-	2010
NISSAN	QUEST	V-6, 3.3 L	2001	-	1999
NISSAN	PATHFINDER	V-6, 3.5 L	2004	-	2001
NISSAN	XTERRA	4 CIL, 2.4 L	2004	-	2000
NISSAN	MURANO	V-6, 3.5 L	2008	-	2007
NISSAN	QUEST	6 CIL, 3.5 L	2006	-	2004
NISSAN	FRONTIER	V-6, 3.3 L	2004	-	1999
NISSAN	350Z	V-6, 3.5 L	2003	-	2003
HYUNDAI	ATOS	4 CIL, 1.0 L	2004	-	2000
NISSAN	ALTIMA	V-6, 3.5 L	2006	-	2002
INFINITI	INFINITI I30	V-6, 3.0 L	2001	-	1997
INFINITI	INFINITI Q45	V-8, 4.5 L	2003	-	2003
NISSAN	SENTRA	4 CIL, 1.8 L	2006	-	2000
NISSAN	SENTRA	4 CIL, 2.0 L	2008	-	2010
NISSAN	MAXIMA	V-6, 3.5 L	2007	-	2002
HYUNDAI	ATOS	4 CIL, 1.1 L	2009	-	2010
FORD	MUSTANG	V-6, 3.8 L	1996	-	1996
NISSAN	ALTIMA	4 CIL, 2.5 L	2006	-	2003
INFINITI	Q45	V-8, 4.5 L	2003	-	2003
MERCURY	MYSTIQUE	4 CIL, 2.0 L	1996	-	1996
NISSAN	SENTRA	4 CIL, 2.5 L	2004	-	2010

31335

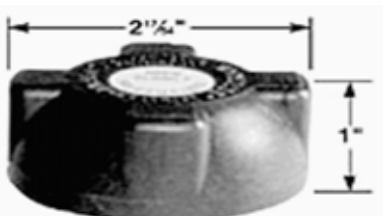

AUDI	A8 QUATTRO	V-8, 4.2 L	2000	-	1999
AUDI	A6	V-6, 2.8 L	1999	-	1999

AUDI	A8	V-8, 4.2 L	2006	-	1999
AUDI	A8	V-8, 3.7 L	1999	-	1998

31336



TOYOTA	LAND CRUISER	V-8, 4.7 L	2007	-	2003
MITSUBISHI	LANCER	4 CIL, 2.4 L	2006	-	2004
FORD	EXPEDITION	V-8, 5.4 L	2009	-	2009
NISSAN	FRONTIER	V6, 4.0 L	2008	-	2008
FORD	EXPLORER	V-8, 5.4 L	2000	-	1999
FORD	RANGER	4 CIL, 2.5 L	2001	-	1999
MITSUBISHI	MONTERO	V-6, 3.8 L	2007	-	2004
NISSAN	FRONTIER	V-6, 4.0 L	2007	-	2005
MITSUBISHI	LANCER	4 CIL, 2.0 L	2006	-	2004
FORD	MUSTANG	V-6, 3.8 L	2001	-	1998
FORD	LOBO	V-8, 4.6 L	2009	-	2010
FORD	EXPLORER SPORT TRAC	V-6, 4.0 L	2006	-	2003
FORD	LOBO	V-8, 5.4 L	2009	-	2010
NISSAN	PATHFINDER	V-6, 4.0 L	2007	-	2005
FORD	RANGER	V-6, 4.0 L	2001	-	1999
SUBARU	FORESTER	4 CIL, 2.5 L	2007	-	2006
FORD	RANGER	4 CIL, 2.3 L	2001	-	1997
FORD	EXPLORER	V-8, 5.0 L	2001	-	1998
FORD	ZX2	4 CIL, 2.0 L	2002	-	2000
TOYOTA	SOLARA	V-6, 3.3 L	2006	-	2005
SUBARU	IMPREZA	4 CIL, 2.5 L	2007	-	2006
MITSUBISHI	OUTLANDER	4 CIL, 2.4 L	2006	-	2004
INFINITI	INFINITI Q45	V-8, 4.1 L	2001	-	1999
FORD	RANGER	V-6, 3.0 L	2002	-	1996
HONDA	ACCORD	4 CIL, 2.4 L	2004	-	2004
SUBARU	LEGACY	4 CIL, 2.5 L	2007	-	2006
SUBARU	OUTBACK	4 CIL, 2.5 L	2007	-	2006
FORD	ESCORT	4 CIL, 2.0 L	1998	-	1997
LINCOLN	NAVIGATOR	V-8, 5.4 L	2008	-	2009
FORD	F-450 SUPER DUTY	V-10, 6.8 L	2007	-	2010
FORD	F-350 SUPER DUTY	V-8, 5.4 L	2007	-	2009
TOYOTA	SIENNA	V-6, 3.3 L	2006	-	2004
MAZDA	MX-5 MIATA	4 CIL, 2.0 L	2007	-	2006
TOYOTA	SIENNA	V-6, 3.0 L	2003	-	2003
FORD	F-150	V-8, 4.6 L	2009	-	2010
SUZUKI	XL-7	V-6, 2.7 L	2006	-	2005
TOYOTA	CAMRY	V-6, 3.0 L	2006	-	2001
NISSAN	XTERRA	V-6, 4.0 L	2007	-	2005
NISSAN	FRONTIER	4 CIL, 2.5 L	2007	-	2005
FORD	WINDSTAR	V-6, 3.0 L	1998	-	1998

## Aplicación por Producto

FORD	F-550 SUPER DUTY	V-10, 6.8 L	2008	-	2010
SUZUKI	GRAND VITARA	V-6, 2.7 L	2008	-	2006

LAND ROVER	RANGE ROVER	V-8, 4.4 L	2006	-	2008
FORD	E SERIES VAN	V-8, 4.6 L	2006	-	2010
FORD	E SERIES VAN	V-8, 5.4 L	2007	-	2010
FORD	SUPER DUTY PICKUP	V-8, 5.4 L	2003	-	2000
FORD	WINDSTAR	V-6, 3.8 L	2003	-	2001
FORD	E SERIES VAN	V-6, 4.2 L	2003	-	2000
FORD	EDGE	V-6, 3.5 L	2007	-	2010
FORD	MUSTANG	V-8, 4.6 L	2007	-	2009
FORD	SUPER DUTY VAN	V-8, 5.4 L	2001	-	2000
FORD	F-250	V-8, 4.6 L	2006	-	1998
FORD	F SERIES PICKUP	V-8, 5.4 L	2002	-	2000
FORD	EXPLORER	V-8, 4.6 L	2007	-	2002
FORD	FREESTAR	V-6, 4.2 L	2007	-	2004
FORD	F SERIES PICKUP	V-8, 4.6 L	2001	-	2000
FORD	FREESTAR	V-6, 3.9 L	2007	-	2004
FORD	F-150	V-6, 4.2 L	2006	-	1999
FORD	F-450 SUPER DUTY	V-8, 7.3 L	2003	-	2001
FORD	EXPLORER	V-8, 5.0 L	2001	-	2001
FORD	LOBO	V-8, 5.4 L	2007	-	2003
FORD	F SERIES PICKUP	V-6, 4.2 L	2001	-	2000
FORD	LOBO	V-8, 4.6 L	2007	-	2002
FORD	RANGER	4 CIL, 2.3 L	2007	-	2010
FORD	F-350 SUPER DUTY	V-8, 5.4 L	2006	-	1999
FORD	EXPLORER	V-6, 4.0 L	2007	-	2001
FORD	F-450 SUPER DUTY	V-10, 6.8 L	2006	-	1999

### 31405

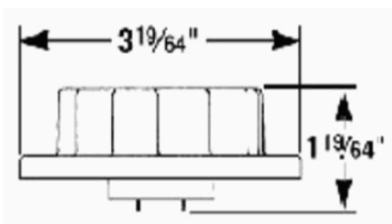

PONTIAC	GRAND AM	V-6, 3.1 L	1998	-	1997
PONTIAC	GRAND AM	4 CIL, 2.4 L	1998	-	1998
CADILLAC	SEVILLE	V-8, 4.6 L	2000	-	2000
CHEVROLET	CORVETTE	V-8, 5.7 L	2000	-	1997
CHEVROLET	CAVALIER	4 CIL, 2.4 L	1998	-	1996

### 31406

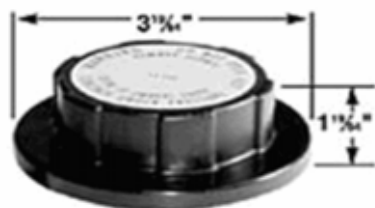

FORD	EXCURSION	V-8, 5.4 L	2002	-	2001
FORD	SUPER DUTY VAN	V-8, 4.6 L	2003	-	2003
LINCOLN	LS	V-6, 3.0 L	2001	-	2000
FORD	ESCAPE	V-6, 3.0 L	2008	-	2010
FORD	SUPER DUTY PICKUP	V-10, 6.8 L	2000	-	2003
LINCOLN	NAVIGATOR	V-8, 5.4 L	2007	-	1998
FORD	EXCURSION	V-10, 6.8 L	2005	-	2001
FORD	FIVE HUNDRED	V-6, 3.0 L	2007	-	2005
LINCOLN	LS	V-8, 3.9 L	2006	-	2000
FORD	SUPER DUTY VAN	V-8, 7.3 L	2001	-	2000
FORD	FOCUS	4 CIL, 2.0 L	2007	-	2010
LINCOLN	AVIATOR	V-8, 4.6 L	2003	-	2005
LINCOLN	MKX	V-6, 3.5 L	2008	-	2007
FORD	EXPEDITION	V-8, 4.6 L	2004	-	1997
LINCOLN	MARK LT	V-8, 5.4 L	2008	-	2007
FORD	EXPEDITION	V-8, 5.4 L	2004	-	2008
FORD	FUSION	4 CIL, 2.3 L	2008	-	2007
NISSAN	TITAN	V-8, 5.6 L	2008	-	2006
FORD	SUPER DUTY VAN	V-6, 4.2 L	2001	-	2003
FORD	MUSTANG	V-6, 4.0 L	2008	-	2010
MERCURY	SABLE	V-6, 3.0 L	2005	-	1996
FORD	SUPER DUTY PICKUP	V-8, 6.0 L DIESEL	2003	-	2003
FORD	SUPER DUTY VAN	V-10, 6.8 L	2002	-	2000
MERCURY	MILAN	V-6, 3.0 L	2007	-	2009
FORD	SUPER DUTY PICKUP	V-8, 7.3 L	2000	-	2000
FORD	FUSION	V-6, 3.0 L	2008	-	2009

### 31411

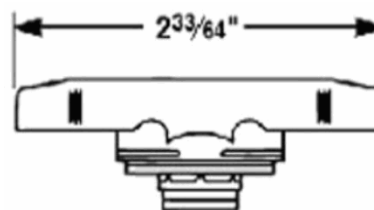

TOYOTA	COROLLA	4 CIL, 1.8 L	2008	-	2002
TOYOTA	SEQUOIA	V-8, 4.7 L	2008	-	2007
TOYOTA	CAMRY	4 CIL, 2.2 L	2002	-	2001
SUBARU	B9 TRIBECA	6 CIL, 3.0 L	2007	-	2006
TOYOTA	MATRIX	4 CIL, 1.8 L	2008	-	2003

### 31412



DODGE	STRATUS	V-6, 3.0 L	2001	-	2001
ACURA	MDX	V-6, 3.5 L	2006	-	2006
HONDA	CIVIC	4 CIL, 1.6 L	2000	-	1998

## Aplicación por Producto

HONDA	CIVIC	4 CIL, 1.8 L	2007	-	2010
ACURA	TL	V-6, 3.2 L	2008	-	2006
SUZUKI	SX4	4 CIL, 2.0 L	2008	-	2010
TOYOTA	SEQUOIA	V-8, 5.7 L	2009	-	2010
TOYOTA	YARIS	4 CIL, 1.5 L	2008	-	2005
DODGE	STRATUS	4 CIL, 2.4 L	2003	-	2003
TOYOTA	CAMRY	4 CIL, 2.4 L	2008	-	2003
HONDA	CR-V	4 CIL, 2.4 L	2007	-	2009
CHEVROLET	TRACKER	4 CIL, 2.0 L	2003	-	1999
TOYOTA	TUNDRA	V-8, 5.7 L	2009	-	2010
CHEVROLET	TRACKER	4 CIL, 1.6 L	2000	-	1997
TOYOTA	TUNDRA	V-8, 4.7 L	2008	-	2007
HONDA	ODYSSEY	V-6, 3.5 L	2007	-	2010
MAZDA	MAZDA 5	4 CIL, 2.3 L	2007	-	2006
TOYOTA	SIENNA	V-6, 3.5 L	2009	-	2010
HONDA	CIVIC	4 CIL, 1.7 L	2005	-	2001
HONDA	CR-V	4 CIL, 2.0 L	2003	-	1999
HONDA	FIT	4 CIL, 1.5 L	2008	-	2010
HONDA	CIVIC HIBRIDO	4 CIL, 1.3 L	2007	-	2010
HONDA	PILOT	V-6, 3.5 L	2007	-	2010
HONDA	RIDGELINE	V-6, 3.5 L	2006	-	2009
TOYOTA	CAMRY	V-6, 3.5 L	2008	-	2007
TOYOTA	TACOMA	V-6, 4.0 L	2008	-	2006
ACURA	RL	V-6, 3.7 L	2009	-	2010
MINIBISHI	ECLIPSE	V-6, 3.8 L	2007	-	2008
MINIBISHI	ENDEAVOR	V-6, 3.8 L	2007	-	2005
CHRYSLER	SEBRING	4 CIL, 2.4 L	2006	-	2004
ACURA	RL	V-6, 3.5 L	2008	-	2006
HONDA	CITY	4 CIL, 1.5 L	2010	-	2010
TOYOTA	FJ CRUISER	V-6, 4.0 L	2008	-	2007
SUZUKI	GRAND VITARA	4 CIL, 2.4 L	2009	-	2010
MINIBISHI	GALANT	4 CIL, 2.4 L	2007	-	2004
MINIBISHI	ECLIPSE	V-6, 3.0 L	2005	-	2004
TOYOTA	4 RUNNER	V-8, 4.7 L	2006	-	2003
HONDA	ACCORD	4 CIL, 2.3 L	2002	-	1999
MINIBISHI	GALANT	V-6, 3.8 L	2007	-	2004
ACURA	MDX	V-6, 3.7 L	2008	-	2007
MINIBISHI	MONTERO SPORT	V-6, 3.5 L	2004	-	2004
CHRYSLER	SEBRING	V-6, 3.0 L	2006	-	2004
TOYOTA	4 RUNNER	V-6, 3.4 L	2002	-	2002
ACURA	TSX	4 CIL, 2.4 L	2009	-	2009
CHEVROLET	TRACKER	V-6, 2.5 L	2004	-	2002
MINIBISHI	ENDEAVOR	V-6, 3.8 L	2004	-	2004
ACURA	RDX	4 CIL, 2.3 L	2008	-	2006
TOYOTA	RAV 4	4 CIL, 2.4 L	2006	-	2003
ACURA	TL	V-6, 3.5 L	2008	-	2009
SUZUKI	AERIO	4 CIL, 2.3 L	2006	-	2005
TOYOTA	RAV 4	4 CIL, 2.0 L	2003	-	2003
HONDA	ACCORD	V-6, 3.5 L	2008	-	2010
TOYOTA	LAND CRUISER	V-8, 5.7 L	2008	-	2010
HONDA	ACCORD	4 CIL, 2.4 L	2007	-	2010
ACURA	TL	V-6, 3.7 L	2009	-	2009

HONDA	ACCORD	V-6, 3.0 L	2007	-	1999
TOYOTA	HIGHLANDER	V-6, 3.5 L	2009	-	2009

### 31516

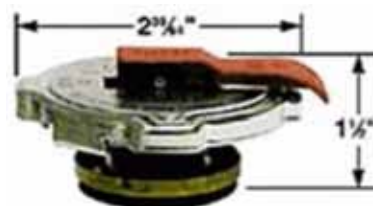

JEEP	CHEROKEE	6 CIL, 4.0 L	2001	-	1999
CHRYSLER	VOYAGER	V-6, 3.8 L	1999	-	1999
CHRYSLER	GRAND VOYAGER	V-6, 3.8 L	2000	-	1999
CHRYSLER	VOYAGER	V-6, 3.3 L	2003	-	1999
DODGE	DURANGO	V-8, 5.2 L	1998	-	1998
CHRYSLER	VOYAGER	V-6, 3.0 L	2001	-	2000
CHRYSLER	CIRRUS	V-6, 2.5 L	2000	-	1999
PONTIAC	TRANS AM FIREBIRD	V-8, 5.7 L	1996	-	1996
CHEVROLET	VENTURE	V-6, 3.4 L	2003	-	1997
CHEVROLET	CENTURY	V-6, 3.1 L	1999	-	1999
DODGE	STRATUS	V-6, 2.7 L	2002	-	2001
CHRYSLER	GRAND VOYAGER	V-6, 3.3 L	2000	-	1999
DODGE	DURANGO	V-8, 5.9 L	1998	-	1998
CHEVROLET	IMPALA	V-6, 3.8 L	2003	-	2000
CHEVROLET	SUBURBAN	V-8, 5.7 L	1996	-	1996
PONTIAC	GRAND PRIX	V-6, 3.8 L	2003	-	1999
DODGE	CARAVAN	V-6, 3.0 L	2002	-	2002
DODGE	CARAVAN	4 CIL, 2.4 L	2002	-	2002
DODGE	STRATUS	V-6, 3.0 L	2002	-	2001
CHEVROLET	IMPALA	V-6, 3.4 L	2003	-	2000
PONTIAC	MONTANA	V-6, 3.5 L	2006	-	2006
CHEVROLET	SUBURBAN	V-8, 7.4 L	1996	-	1996
DODGE	DURANGO	V-6, 3.9 L	1998	-	1998
DODGE	CARAVAN	V-6, 3.8 L	2002	-	2002
CHRYSLER	CIRRUS	4 CIL, 2.0 L	2000	-	2000
CHRYSLER	CIRRUS	4 CIL, 2.4 L	2000	-	1999
DODGE	CARAVAN	V-6, 3.3 L	2004	-	1999
CHEVROLET	LUMINA	V-6, 3.1 L	1998	-	1996
DODGE	CARAVAN	V-6, 3.3 L FLEX	2003	-	2001
PONTIAC	GRAND PRIX	V-6, 3.1 L	2002	-	1999

### 31518



DODGE	INTREPID	V-6, 2.7 L	2003	-	1999
-------	----------	------------	------	---	------

## Aplicación por Producto

DODGE	DAKOTA	V-6, 3.7 L	2008	-	2007
DODGE	DURANGO	V-8, 4.7 L	2006	-	2006
DODGE	DURANGO	V-8, 5.2 L	1999	-	1999
DODGE	DURANGO	V-8, 5.9 L	1999	-	1999
DODGE	NEON	4 CIL, 2.4 L	2004	-	2003
CHEVROLET	BLAZER	V-6, 4.3 L	2004	-	1996
DODGE	INTREPID	V-6, 3.2 L	2001	-	1999
DODGE	INTREPID	V-6, 3.5 L	2002	-	1999
MINI	COOPER	4 CIL, 1.6 L	2008	-	2008
DODGE	JOURNEY	V-6, 3.5 L	2010	-	2010
DODGE	AVENGER	4 CIL, 2.4 L	2008	-	2007
DODGE	AVENGER	4 CIL, 2.0 L	2008	-	2007
CHRYSLER	CONCORDE	V-6, 3.2 L	2001	-	1998
CHRYSLER	300M	V-6, 3.5 L	2003	-	1999
CHRYSLER	PT CRUISER	4 CIL, 2.4 L	2002	-	2001
CHRYSLER	CONCORDE	V-6, 2.7 L	2000	-	1998

DODGE	STRATUS	V-6, 3.0 L	2002	-	2001
CHRYSLER	GRAND VOYAGER	V-6, 3.3 L	2000	-	1999
CHRYSLER	TOWN & COUNTRY	V6, 4.0 L	2008	-	2010
CHEVROLET	LUMINA	V-6, 3.1 L	1998	-	1996
CHEVROLET	EXPRESS VAN PASAJEROS	V-6, 4.3 L	2000	-	1998
CHEVROLET	EXPRESS VAN	V-6, 4.3 L	2000	-	1998
CHRYSLER	VOYAGER	V-6, 3.0 L	2001	-	2000
DODGE	STRATUS	V-6, 2.7 L	2002	-	2001
CHRYSLER	VOYAGER	V-6, 3.8 L	1999	-	1999
CHEVROLET	EXPRESS	V-8, 5.7 L	2002	-	2001
CHRYSLER	SEBRING	4 CIL, 2.4 L	1999	-	1996
CHRYSLER	GRAND VOYAGER	V-6, 3.8 L	2000	-	2000
CHEVROLET	EXPRESS	V-8, 6.5 L	2000	-	2000
CHRYSLER	GRAND VOYAGER	V-6, 3.8 L	1999	-	1999
CHRYSLER	CIRRUS	4 CIL, 2.0 L	2000	-	2000
CHEVROLET	EXPRESS	V-8, 8.1 L	2002	-	2001
CHRYSLER	VOYAGER	V-6, 3.3 L	2007	-	1999
PONTIAC	GRAND AM	V-6, 3.4 L	2005	-	2005
JEEP	CHEROKEE	4 CIL, 2.5 L	1998	-	1996
JEEP	CHEROKEE	6 CIL, 4.0 L	2001	-	1996
CHEVROLET	MALIBU	V-6, 3.1 L	2002	-	1999
JEEP	WRANGLER	6 CIL, 4.0 L	1999	-	1999
DODGE	RAM WAGON 3500	V-8, 5.2 L	2000	-	2000
CHEVROLET	EXPRESS	V-6, 4.3 L	2002	-	2001
CHEVROLET	IMPALA	V-6, 3.8 L	2004	-	2000
DODGE	CARAVAN	V-6, 3.3 L FLEX	2003	-	2001
OLDSMOBILE	SILHOUETTE	V-6, 3.4 L	1996	-	1996
CHEVROLET	IMPALA	V-6, 3.4 L	2004	-	2000
OLDSMOBILE	EIGHTY EIGHT	V-6, 3.8 L	1999	-	1998
PONTIAC	GRAND PRIX	V-6, 3.1 L	2002	-	1997
CHEVROLET	C y K SERIES PICKUP	V-8, 7.4 L	2000	-	1999
DODGE	DURANGO	V-8, 5.9 L	1998	-	1998
PONTIAC	AZTEK	V-6, 3.4 L	2005	-	2001
PONTIAC	SUNFIRE	4 CIL, 2.2 L	2003	-	2003
DODGE	DURANGO	V-8, 5.2 L	1998	-	1998
CHEVROLET	C y K SERIES PICKUP	V-8, 8.1 L	2002	-	2001
DODGE	CARAVAN	V-6, 3.8 L	2002	-	2002
DODGE	DURANGO	V-6, 3.9 L	1998	-	1998
PONTIAC	GRAND PRIX	V-6, 3.8 L	2004	-	1997

### 31522

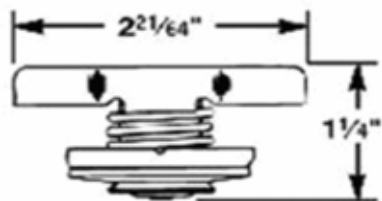

DODGE	DURANGO	V-8, 4.7 L	2005	-	2000
MERCEDES BE	SLK230	4 CIL, 2.3 L	2000	-	1998
DODGE	DURANGO	V-8, 5.9 L	2003	-	1998
DODGE	DURANGO	V-8, 5.2 L	2000	-	1998
DODGE	DURANGO	V-8, 5.7 L	2007	-	2009
MERCEDES BE	C230	4 CIL, 2.3 L	2000	-	1997
CHRYSLER	ASPEN	V-8, 5.7 L	2007	-	2009
DODGE	DURANGO	V-6, 3.9 L	1999	-	1998
DODGE	DURANGO	V-6, 3.7 L	2005	-	2005
JEEP	GRAND CHEROKEE	V-8, 4.7 L	2002	-	1999

### 31523

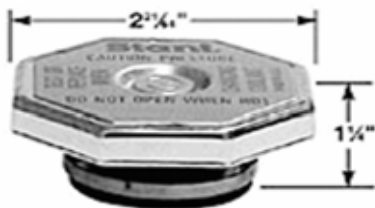

CHEVROLET	VENTURE	V-6, 3.4 L	2005	-	2004
CHEVROLET	EXPRESS	V-8, 5.0 L	2002	-	2000
DODGE	CARAVAN	V-6, 3.0 L	2002	-	2002
CHEVROLET	SUBURBAN	V-8, 7.4 L	1996	-	1996
CHEVROLET	UPLANDER	V-6, 3.5 L	2007	-	2005
DODGE	CARAVAN	4 CIL, 2.4 L	2002	-	2002
DODGE	CARAVAN	V-6, 3.3 L	2007	-	1999

### 31525



JEEP	GRAND CHEROKEE	V-6, 3.7 L	2007	-	2009
CHRYSLER	PT CRUISER	4 CIL, 2.4 L	2007	-	2004
JEEP	GRAND CHEROKEE	V-8, 4.0 L	2001	-	1999

## Aplicación por Producto

CHRYSLER	CIRRUS	4 CIL, 2.4 L	2005	-	2005
CHRYSLER	300 C	V-6, 3.5 L	2006	-	2009
CADILLAC	DEVILLE	V-8, 4.6 L	2005	-	1997
JEEP	GRAND CHEROKEE	V-8, 4.7 L	2007	-	1999
CHRYSLER	300 C	V-8, 5.7 L	2006	-	2009
CHRYSLER	PACIFICA	V-6, 3.5 L	2004	-	2004
JEEP	GRAND CHEROKEE	6 CIL, 4.0 L	2002	-	1997
JEEP	COMMANDER	V-8, 5.7 L	2008	-	2006
CHRYSLER	300 C	V-8, 6.1 L	2006	-	2005
JEEP	GRAND CHEROKEE	V-6, 4.0 L	2004	-	2003
DODGE	STRATUS	4 CIL, 2.4 L	2004	-	2004
DODGE	NEON	4 CIL, 2.0 L	2006	-	2005
DODGE	JOURNEY	4 CIL, 2.4 L	2009	-	2010
DODGE	NEON	4 CIL, 2.4 L	2006	-	2004
DODGE	CHARGER	V-8, 6.1 L	2008	-	2009
DODGE	STRATUS	4 CIL, 2.0 L	2006	-	2005
JEEP	LIBERTY	V-6, 3.7 L	2002	-	2009
DODGE	CHARGER	V-6, 3.5 L	2008	-	2009
JEEP	GRAND CHEROKEE	V-8, 5.9 L	1998	-	1998
DODGE	NITRO	V-6, 3.7 L	2008	-	2010
DODGE	DURANGO	V-8, 5.2 L	2000	-	2000
JEEP	WRANGLER	6 CIL, 4.0 L	2003	-	2000
JEEP	WRANGLER	4 CIL, 2.5 L	2002	-	1997
JEEP	WRANGLER	4 CIL, 2.4 L	2006	-	2003
DODGE	NITRO	V-6, 4.0 L	2009	-	2010
DODGE	CHARGER	V-8, 5.7 L	2008	-	2009
PONTIAC	FIREBIRD TRANS AM	V-8, 5.7 L	2002	-	1997
CHEVROLET	CAMARO Z28	V-6, 3.8 L	2002	-	1996
CHEVROLET	CAMARO Z28	V-8, 5.7 L	2002	-	2000

CHEVROLET	BLAZER	V-6, 4.3 L	2005	-	1996
DODGE	RAM SERIES PICKUP	V-8, 4.7L	2003	-	2002
DODGE	AVENGER	4 CIL, 2.0 L	2008	-	2009
DODGE	INTREPID	V-6, 2.7 L	2003	-	1998
CHEVROLET	S-10	4 CIL, 2.2 L	2003	-	1996
DODGE	NEON	4 CIL, 2.4 L	2004	-	2003
JEEP	LIBERTY	V-6, 3.7 L	2007	-	2003
DODGE	NEON	4 CIL, 2.0 L	2004	-	1996
DODGE	STRATUS	V-6, 2.7 L	2002	-	2002
CHRYSLER	CONCORDE	V-6, 2.7 L	2000	-	1998
CHRYSLER	300M	V-6, 3.5 L	2004	-	2004
CHRYSLER	CONCORDE	V-6, 3.2 L	2001	-	1998
CHEVROLET	S-10	V-6, 4.3 L	2002	-	1996
JEEP	PATRIOT	4 CIL, 2.4 L	2008	-	2010
CHRYSLER	SEBRING	V-6, 2.5 L	2000	-	1997
DODGE	INTREPID	V-6, 3.2 L	2001	-	1998
CHRYSLER	PT CRUISER	4 CIL, 2.4 L	2003	-	2000
MINI	COOPER	4 CIL, 1.6 L	2006	-	2005
DODGE	RAM 2500	V-8, 5.9 L	2002	-	2002
DODGE	INTREPID	V-6, 3.5 L	2002	-	1997
DODGE	DURANGO	V-8, 5.9 L	1999	-	1999
DODGE	JOURNEY	V-6, 3.5 L	2009	-	2010
DODGE	RAM 1500	V-6, 3.7 L	2005	-	2009
DODGE	RAM 1500	V-6, 3.9 L	2001	-	1999
HUMMER	H1	V-8, 6.6 L	2007	-	2006
DODGE	RAM 2500	V-8, 4.7 L	2004	-	2009
DODGE	DAKOTA	V-6, 3.7 L	2009	-	2009
DODGE	AVENGER	4 CIL, 2.4 L	2008	-	2009
DODGE	RAM 2500	V-8, 5.7 L	2008	-	2009
DODGE	RAM MAXI VAN 3500	V-8, 5.9 L	2002	-	2002
JEEP	WRANGLER	V-6, 3.8 L	2008	-	2009
JEEP	COMPASS	4 CIL, 2.4 L	2008	-	2010
DODGE	RAM 3500	V-8, 5.7 L	2007	-	2003
DODGE	RAM 4000	V-6, 5.9 L DIESEL	2008	-	2008
DODGE	DURANGO	V-8, 5.2 L	1999	-	1998
CADILLAC	SEVILLE	V-8, 4.6 L	1999	-	1998
DODGE	RAM 4000	V-6, 6.7 L DIESEL	2008	-	2009
DODGE	RAM MAXI VAN 1500	V-6, 3.9 L	2002	-	2002
DODGE	STRATUS	4 CIL, 2.0 L	2004	-	2004
DODGE	RAM 2500	V-8, 4.7L	2003	-	2002

### 31527

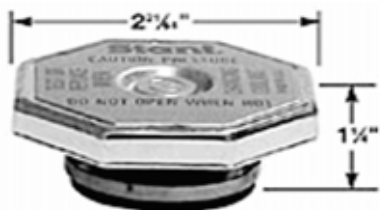

FORD	EXPLORER	V-8, 5.0 L	1999	-	1998
FORD	F-450 SUPER DUTY	V-8, 7.5 L	1997	-	1997

### 31528

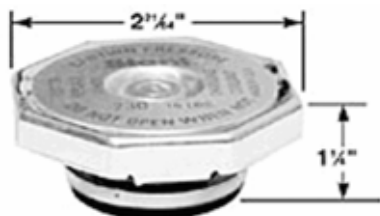

DODGE	RAM MAXI WAGON 3500	V-8, 5.9 L	2002	-	2002
DODGE	RAM SERIES PICKUP	V-6, 3.7 L	2003	-	2002

### 31529

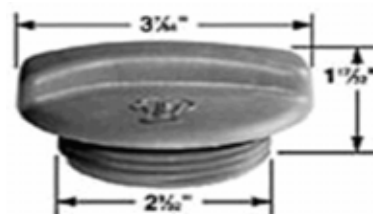

AUDI	A8	V-8, 4.2 L	2007	-	2007
VOLKSWAGEN	GOLF	4 CIL, 2.0 L	2006	-	2000

## Aplicación por Producto

VOLKSWAGEN	GOLF	4 CIL, 1.8 L	2006	-	1999
VOLKSWAGEN	GLI	4 CIL, 2.0 L TURB2008		-	2007
AUDI	A8 QUATTRO	V-8, 4.2 L	2005	-	2004
AUDI	ALLROAD QUATTRO	V-6, 2.7 L	2006	-	2002
AUDI	S4 QUATTRO	V-6, 2.7 L	2002	-	2000
VOLKSWAGEN	BORA SPORTWAGEN	5 CIL. 2.5 L	2008	-	2009
VOLKSWAGEN	BORA	5 CIL. 2.5 L	2009	-	2009
AUDI	TT	4 CIL, 1.8 L	2006	-	2000
AUDI	Q7	V-8, 4.2 L	2007	-	2007
AUDI	A6	V-6, 3.2 L	2007	-	2008
VOLKSWAGEN	BORA	4 CIL, 1.9 L DIESE2007		-	2007
VOLKSWAGEN	BEETLE	5 CIL. 2.5 L	2009	-	2010
VOLKSWAGEN	BEETLE	5 CIL, 2.5 L	2008	-	2006
VOLKSWAGEN	BEETLE	4 CIL, 2.0 L	2008	-	1998
VOLKSWAGEN	BEETLE	4 CIL, 1.8 L	2005	-	1999
VOLKSWAGEN	BORA	5 CIL, 2.5 L	2008	-	2005
VOLKSWAGEN	TOUAREG	V-6, 3.2 L	2006	-	2005
AUDI	A3	4 CIL, 2.0 L	2007	-	2008
AUDI	A3	V-6, 3.2 L	2007	-	2008
VOLKSWAGEN	TOUAREG	V-6, 3.6 L	2007	-	2008
VOLKSWAGEN	GOLF	V-6, 2.8 L	2000	-	2000
AUDI	A4	4 CIL, 1.8 L	2006	-	1998
VOLKSWAGEN	PASSAT	V-6, 3.6 L	2008	-	2007
VOLKSWAGEN	PASSAT	V-6, 2.8 L	2005	-	1998
AUDI	A4	4 CIL, 2.0 L	2007	-	2007
VOLKSWAGEN	PASSAT	4 CIL, 2.0 L	2008	-	2007
AUDI	A4	V-6, 2.8 L	2000	-	1998
VOLKSWAGEN	PASSAT	4 CIL, 1.8 L	2005	-	1999
VOLKSWAGEN	JETTA	V-6, 2.8 L	2002	-	1999
VOLKSWAGEN	JETTA	4 CIL, 2.0 L	2008	-	2010
AUDI	A6	V-6, 3.0 L	2006	-	2002
VOLKSWAGEN	TOUAREG	V-8, 4.2 L	2007	-	2005
AUDI	A4	V-6, 3.0 L	2006	-	2002
VOLKSWAGEN	GTI	4 CIL, 2.0 L	2000	-	1999
AUDI	A8	V8, 4.2 L	2008	-	2009
VOLKSWAGEN	GTI	4 CIL, 2.0 L TURB2008		-	2007
AUDI	A6	V-6, 2.8 L	2001	-	1998
VOLKSWAGEN	GTI	V-6, 2.8 L	2001	-	2000
VOLKSWAGEN	JETTA	4 CIL, 1.8 L	2006	-	1999
AUDI	A4	V-6, 3.2 L	2007	-	2009
VOLKSWAGEN	JETTA	4 CIL, 1.9 L DIESE2005		-	2000

### 31532



CHEVROLET	IMPALA	V-6, 3.4 L	2005	-	2005
HUMMER	H2	V-8, 6.2 L	2008	-	2010
HUMMER	H2	V-8, 6.0 L	2007	-	2006
CHEVROLET	SUBURBAN	V-8, 7.4 L	2004	-	2000
GMC	YUKON	V-8, 6.2 L	2008	-	2010
GMC	YUKON	V-8, 5.3 L	2008	-	2007
GMC	SIERRA	V-8, 6.2 L	2009	-	2010
CHEVROLET	AVALANCHE	V-8, 5.3 L	2007	-	2010
GMC	SIERRA	V-8, 5.3 L	2009	-	2010
PONTIAC	GRAND PRIX	V-6, 3.8 L	2005	-	2005
HUMMER	H3	5 CIL, 3.5 L	2007	-	2006
GMC	CANYON	5 CIL, 3.7 L	2008	-	2010
GMC	ACADIA	V-6, 3.6 L	2009	-	2010
PONTIAC	GRAND AM	V-6, 3.4 L	2004	-	1999
PONTIAC	G6	V-6, 3.9 L	2006	-	2006
PONTIAC	GRAND AM	4 CIL, 2.2 L	2003	-	2002
PONTIAC	G4	4 CIL, 2.4 L	2006	-	2006
CHEVROLET	IMPALA	V-6, 3.8 L	2005	-	2004
PONTIAC	GRAND AM	4 CIL, 2.4 L	2001	-	1999
CHEVROLET	MALIBU	4 CIL, 2.4 L	2008	-	2010
PONTIAC	G6	V-6, 3.6 L	2008	-	2007
PONTIAC	G4	4 CIL, 2.2 L	2006	-	2006
HUMMER	H3	5 CIL, 3.7 L	2008	-	2010
PONTIAC	G5	4 CIL, 2.2 L	2008	-	2007
CHEVROLET	MALIBU	V-6, 3.1 L	2003	-	1999
CHEVROLET	MONTE CARLO	V-6, 3.8 L	2005	-	2004
PONTIAC	G5	4 CIL, 2.4 L	2008	-	2007
CHEVROLET	MONTE CARLO	V-6, 3.4 L	2005	-	2004
CHEVROLET	MALIBU	V-6, 3.5 L	2007	-	2003
CHEVROLET	MALIBU	4 CIL, 2.2 L	2007	-	2004
CHEVROLET	EXPRESS CARGO VAN	V-6, 4.3 L	2007	-	2010
CHEVROLET	EXPRESS	V-8, 5.7 L	1999	-	1999
CHEVROLET	TRAILBLAZER	V-8, 5.3 L	2003	-	2003
CADILLAC	SRX	V-6, 3.6 L	2006	-	2004
CHEVROLET	EXPRESS	V-8, 6.0 L	2007	-	2010
CHEVROLET	UPLANDER	V-6, 3.9 L	2006	-	2009
CHEVROLET	SILVERADO	V-8, 6.6 L	2001	-	2001
CHEVROLET	EXPRESS	V-8, 7.4 L	1999	-	1999
CHEVROLET	MALIBU	V-6, 3.6 L	2008	-	2010
CADILLAC	SRX	V-8, 4.6 L	2004	-	2004
CHEVROLET	SUBURBAN	V-8, 6.0 L	2004	-	2003
CHEVROLET	SUBURBAN	V-8, 5.7 L	2004	-	2000
CHEVROLET	EXPRESS	V-8, 5.3 L	2007	-	2010

### 31530



FORD	FOCUS	4 CIL, 2.0 L	2004	-	2000
------	-------	--------------	------	---	------



## Aplicación por Producto

CADILLAC	CTS	V-6, 3.6 L	2006 - 2005
CADILLAC	ESCALADE	V-8 6.2 L	2008 - 2010
CADILLAC	CTS	V-6, 3.2 L	2004 - 2003
CHEVROLET	SONORA	V-8, 5.3 L	2003 - 2003
CHEVROLET	EXPRESS CARGO VAN	V-8, 5.7 L	2000 - 1998
CHEVROLET	SILVERADO	V-8, 8.1 L	2001 - 2001
PONTIAC	SOLSTICE	4 CIL, 2.4 L	2008 - 2006
CHEVROLET	HHR	4 CIL, 2.4 L	2008 - 2010
BUICK	ENCLAVE	V-6, 3.6 L	2010 - 2010
CHEVROLET	SILVERADO	V-6, 4.3 L	2007 - 2010
CHEVROLET	SILVERADO	V-8, 4.8 L	2007 - 2010
CHEVROLET	SILVERADO	V-8, 5.3 L	2001 - 2010
CHEVROLET	SILVERADO	V-8, 6.0 L	2007 - 2000
CHEVROLET	SUBURBAN	V-8, 5.3 L	2007 - 2010
CHEVROLET	COLORADO	5 CIL, 3.5 L	2006 - 2004
PONTIAC	SUNFIRE	4 CIL, 2.4 L	2002 - 2000
CHEVROLET	TAHOE	V-8, 5.3 L	2007 - 2010
CHEVROLET	TAHOE	V-8, 4.8 L	2007 - 2006
PONTIAC	TORRENT	V-6, 3.4 L	2008 - 2006
CHEVROLET	CAPTIVA	V-6, 3.6 L	2009 - 2010
CADILLAC	ESCALADE	V-8, 5.7 L	2000 - 1999
CHEVROLET	COLORADO	4 CIL, 2.8 L	2006 - 2005
MAZDA	MAZDA 6	V-6, 3.0 L	2007 - 2008
CADILLAC	ESCALADE	V-8, 6.0 L	2006 - 2002
CHEVROLET	CAPTIVA	4 CIL, 2.4 L	2009 - 2010
CHEVROLET	TRAILBLAZER	6 CIL, 4.2 L	2007 - 2002
CHEVROLET	COLORADO	4 CIL, 2.9 L	2007 - 2010
SUZUKI	XL-7	V-6, 3.6 L	2008 - 2009
CHEVROLET	EXPRESS	V-6, 4.3 L	2003 - 2003
PONTIAC	SUNFIRE	4 CIL, 2.2 L	2004 - 2005
CHEVROLET	SUBURBAN	V-8, 8.1 L	2004 - 2000
CHEVROLET	EQUINOX	V-6, 3.4 L	2007 - 2005
CADILLAC	ESCALADE	V-8, 6.2 L	2007 - 2007
CHEVROLET	CAVALIER	4 CIL, 2.4 L	1999 - 1996
CHEVROLET	COLORADO	5 CIL, 3.7 L	2007 - 2010
CADILLAC	ESCALADE	V-8, 5.3 L	2004 - 2002

NISSAN	XTERRA	V-6, 3.3 L	2002 - 2000
NISSAN	FRONTIER	V-6, 3.3 L	2004 - 1999
NISSAN	ALTIMA	4 CIL, 2.5 L	2006 - 2003
NISSAN	QUEST	V-6, 3.3 L	2001 - 1999
HYUNDAI	ATOS	4 CIL, 1.0 L	2004 - 2000
NISSAN	SENTRA	4 CIL, 2.0 L	2002 - 2010
INFINITI	INFINITI I30	V-6, 3.0 L	2001 - 1997
INFINITI	INFINITI Q45	V-8, 4.5 L	2003 - 2003
MERCURY	MYSTIQUE	4 CIL, 2.0 L	1996 - 1996
INFINITI	Q45	V-8, 4.5 L	2003 - 2003
NISSAN	PATHFINDER	V-6, 3.3 L	2000 - 1998
NISSAN	TIIDA	4 CIL, 1.8 L	2009 - 2010
NISSAN	SENTRA	4 CIL, 1.8 L	2006 - 2000
NISSAN	SENTRA	4 CIL, 2.5 L	2004 - 2010
NISSAN	FRONTIER	4 CIL, 2.4 L	2004 - 1999
NISSAN	MAXIMA	V-6, 3.5 L	2006 - 2002
NISSAN	XTERRA	4 CIL, 2.4 L	2004 - 2000
NISSAN	QUEST	V-6, 3.0 L	1998 - 1997
NISSAN	QUEST	6 CIL, 3.5 L	2006 - 2004

### 31534



MITSUBISHI	LANCER	4 CIL, 2.0 L	2007 - 2008
MITSUBISHI	OUTLANDER	V-6, 3.0 L	2007 - 2008
NISSAN	QUEST	V-6, 3.5 L	2008 - 2009
NISSAN	350Z	V-6, 3.5 L	2007 - 2009
NISSAN	ARMADA	V-8, 5.6 L	2006 - 2010

### 31535



NISSAN	PATHFINDER	V-6, 3.5 L	2004 - 2001
NISSAN	QUEST	6 CIL, 3.3 L	2002 - 2002
NISSAN	ALTIMA	V-6, 3.5 L	2006 - 2002
NISSAN	MURANO	6 CIL, 3.5 L	2006 - 2004
NISSAN	350Z	V-6, 3.5 L	2006 - 2003
FORD	MUSTANG	V-6, 3.8 L	1996 - 1996

JEEP	GRAND CHEROKEE	V-8, 5.7 L	2008 - 2009
JEEP	GRAND CHEROKEE	V-8, 4.7 L	2004 - 2004
JEEP	COMMANDER	V-8, 5.7 L	2009 - 2009
JEEP	WRANGLER	V-6, 4.0 L	2004 - 2004
CHRYSLER	PACIFICA	V-6, 3.5 L	2006 - 2005
JEEP	GRAND CHEROKEE	V-8, 6.1 L	2008 - 2009
CHRYSLER	PACIFICA	V-6, 4.0 L	2008 - 2007
DODGE	JOURNEY	4 CIL, 2.4 L	2009 - 2010
JEEP	WRANGLER	6 CIL, 4.0 L	2006 - 2005

## Aplicación por Producto

JEEP	WRANGLER	V-6, 3.8 L	2007	-	2007
------	----------	------------	------	---	------

**31541**



TOYOTA	RAV 4	4 CIL, 2.5 L	2009	-	2010
TOYOTA	RAV 4	V-6, 3.5 L	2008	-	2010
TOYOTA	RAV 4	4 CIL, 2.4 L	2007	-	2008

**31544**



CHEVROLET	CORVETTE	V-8, 5.7 L	2004	-	2004
CADILLAC	SEVILLE	V-8, 4.6 L	2004	-	2001

**31546**



SAAB	9 - 3	4 CIL, 2.3 L	2002	-	2001
CHEVROLET	AVEO	4 CIL, 1.6 L	2009	-	2009
PONTIAC	G3	4 CIL, 1.6 L	2008	-	2006
CHEVROLET	AVEO	4 CIL, 1.6 L	2008	-	2008
SAAB	9 - 3	4 CIL, 2.0 L	2002	-	2002
SAAB	9 - 5	V-6, 3.0 L	2003	-	2003
CADILLAC	CATERA	V-6, 3.0 L	2001	-	1998
SAAB	9 - 5	4 CIL, 2.3 L	2002	-	2002

**31548**



SAAB	9 - 5	4 CIL, 2.3 L	2007	-	2004
------	-------	--------------	------	---	------

**31536**



DODGE	DURANGO	V-6, 3.9 L	1999	-	1998
FORD	ESCORT	4 CIL, 2.0 L	2002	-	1999
DODGE	DURANGO	V-8, 5.9 L	2003	-	1998
DODGE	DURANGO	V-8, 4.7 L	2004	-	2000
DODGE	DURANGO	V-8, 5.7 L	2004	-	2004
DODGE	DURANGO	V-8, 5.2 L	2000	-	1998
DODGE	DURANGO	V-6, 3.7 L	2004	-	2004

**31539**



MERCURY	MYSTIQUE	V-6, 2.5 L	2000	-	1998
MERCURY	MARINER	4 CIL, 2.3 L	2007	-	2005
FORD	ESCAPE	4 CIL, 2.5 L	2009	-	2010
FORD	ESCAPE	4 CIL, 2.3 L	2007	-	2008
FORD	ESCAPE	4 CIL, 2.0 L	2002	-	2001
FORD	CONTOUR	4 CIL, 2.0 L	2000	-	1998
MERCURY	MARINER	V-6, 3.0 L	2007	-	2009
FORD	CONTOUR	V-6, 2.5 L	2000	-	1998
MERCURY	MYSTIQUE	4 CIL, 2.0 L	2000	-	1998
FORD	ESCAPE	V-6, 3.0 L	2007	-	2001

**31540**



MERCEDES BE	CLK55	V-8, 5.5 L	2006	-	2001
-------------	-------	------------	------	---	------

### RC216

31549



MAZDA	MAZDA 3	4 CIL, 2.0 L	2009	-	2009
-------	---------	--------------	------	---	------



FIAT	DUCATO	4 CIL, 2.3 L DIESE	2008	-	2010
FIAT	DUCATO	4 CIL, 3.0 L DIESE	2008	-	2010

31551



NISSAN	ALTIMA	4 CIL, 2.5 L	2008	-	2010
NISSAN	MURANO	V-6, 3.5 L	2009	-	2010
MAZDA	CX-7	4 CIL, 2.3 L	2008	-	2006
MAZDA	MAZDA 6	4 CIL, 2.3 L	2007	-	2008
FORD	EXPLORER SPORT TRAC	V-8, 4.6 L	2007	-	2009
FORD	EXPLORER SPORT TRAC	V-6, 4.0 L	2007	-	2009
FORD	EXPLORER	V-8, 4.6 L	2007	-	2009
FORD	EXPLORER	V-6, 4.0 L	2007	-	2009
NISSAN	ALTIMA	V-6, 3.5 L	2008	-	2009
NISSAN	MAXIMA	V-6, 3.5 L	2009	-	2008
MAZDA	CX-9	V-6, 3.7 L	2008	-	2007

31845



HYUNDAI	ATTITUDE	4 CIL, 1.4 L	2008	-	2010
HYUNDAI	ATTITUDE	4 CIL, 1.6 L	2008	-	2010

## Aplicación por Producto

### Tensores y Poleas

**30006**



FORD	EXPLORER SPORT TRAC	V-8, 4.6 L	2007	-	2010
FORD	EXPLORER	V-8, 4.6 L	2007	-	2010

**36026**



Acero D.E. 70mm D.B. 12mm A - 30mm V-Ranurada

TOYOTA	4 RUNNER	V-8, 4.7 L	2007	-	2003
TOYOTA	SEQUOIA	V-8, 4.7 L	2008	-	2007
TOYOTA	TUNDRA	V-8, 4.7 L	2008	-	2007
TOYOTA	LAND CRUISER	V-8, 4.7 L	2006	-	2003

**36079**



SAAB	9 - 5	V-6, 3.0 L	2003	-	2003
SAAB	9 - 5	4 CIL, 2.3 L	2007	-	2002
SAAB	9 - 3	4 CIL, 2.0 L	2002	-	2002

**36086**



HYUNDAI	ATTITUDE	4 CIL, 1.6 L	2006	-	2007
HYUNDAI	ATTITUDE	4 CIL, 1.6 L	2008	-	2010

HYUNDAI	ATTITUDE	4 CIL, 1.4 L	2008	-	2010
---------	----------	--------------	------	---	------

**36087**



Acero D.E. 78mm D.B. 12mm A - 20mm Lisa

NISSAN	MURANO	6 CIL, 3.5 L	2006	-	2006
NISSAN	QUEST	V-6, 3.5 L	2007	-	2007
NISSAN	QUEST	V-6, 3.5 L	2008	-	2009
NISSAN	QUEST	6 CIL, 3.5 L	2006	-	2006
NISSAN	MURANO	V-6, 3.5 L	2004	-	2003
NISSAN	ALTIMA	V-6, 3.5 L	2006	-	2002
NISSAN	MAXIMA	V-6, 3.5 L	2005	-	2002

**36100**



Acero D.E. 76mm D.B. 17mm A - 29.5mm V-Ranurada

FORD	MUSTANG	V-8, 4.6 L	2004	-	2000
MERCURY	GRAND MARQUIS	V-8, 4.6 L	2004	-	2003
DODGE	INTREPID	V-6, 2.7 L	2003	-	1998
LINCOLN	TOWN CAR	V-8, 4.6 L	2006	-	2001
CHRYSLER	CONCORDE	V-6, 2.7 L	2000	-	1998

**36101**



Acero D.E. 70mm D.B. 17mm A - 31mm Lisa

GMC	CANYON	5 CIL, 3.7 L	2008	-	2007
CHEVROLET	COLORADO	4 CIL, 2.9 L	2007	-	2007
CHEVROLET	COLORADO	4 CIL, 2.9 L	2008	-	2010
CHEVROLET	TRAILBLAZER	6 CIL, 4.2 L	2007	-	2002
CHEVROLET	COLORADO	4 CIL, 2.8 L	2006	-	2005
GMC	CANYON	4 CIL, 2.9 L	2007	-	2007
CHEVROLET	COLORADO	5 CIL, 3.7 L	2008	-	2010
CHEVROLET	COLORADO	5 CIL, 3.7 L	2007	-	2007
CHEVROLET	COLORADO	5 CIL, 3.5 L	2006	-	2004

## Aplicación por Producto

HUMMER	H3	5 CIL, 3.7 L	2008 - 2010
HUMMER	H3	5 CIL, 3.5 L	2007 - 2006
GMC	CANYON	5 CIL, 3.7 L	2009 - 2010

HONDA	PILOT	V-6, 3.5 L	2008 - 2008
ACURA	TL	V-6, 3.5 L	2008 - 2010
ACURA	RL	V-6, 3.7 L	2009 - 2010

**36105**



VOLKSWAGEN	BEETLE	5 CIL, 2.5 L	2009 - 2010
VOLKSWAGEN	BORA SPORTWAGEN	5 CIL, 2.5 L	2008 - 2009
VOLKSWAGEN	BORA	5 CIL, 2.5 L	2005 - 2009

**36106**



VOLKSWAGEN	BORA SPORTWAGEN	5 CIL, 2.5 L	2008 - 2009
VOLKSWAGEN	BORA	5 CIL, 2.5 L	2005 - 2009

**36112**

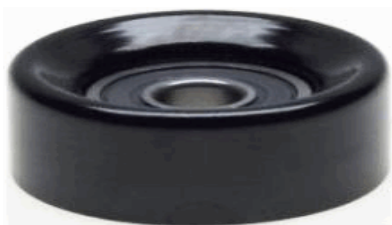

Acero D.E. 76.3mm D.B. 17mm A - 29.5mm Lisa

ACURA	MDX	V-6, 3.7 L	2007 - 2007
ACURA	RL	V-6, 3.5 L	2007 - 2006
ACURA	MDX	V-6, 3.5 L	2006 - 2006
ACURA	TSX	V-6, 3.5 L	2010 - 2010
ACURA	TL	V-6, 3.2 L	2007 - 2006
HONDA	RIDGELINE	V-6, 3.5 L	2008 - 2010
ACURA	TL	V-6, 3.7 L	2009 - 2010
HONDA	ODYSSEY	V-6, 3.5 L	2007 - 2005
ACURA	MDX	V-6, 3.7 L	2008 - 2010
HONDA	ACCORD	V-6, 3.0 L	2007 - 2003
ACURA	TL	V-6, 3.2 L	2008 - 2008
HONDA	ODYSSEY	V-6, 3.5 L	2008 - 2010
HONDA	RIDGELINE	V-6, 3.5 L	2007 - 2006
ACURA	RL	V-6, 3.5 L	2008 - 2008
HONDA	PILOT	V-6, 3.5 L	2007 - 2005

**36115**



Acero D.E. 83.5mm D.B. 12mm A - 18mm Lisa

NISSAN	MAXIMA	V-6, 3.0 L	2004 - 1993
--------	--------	------------	-------------

**36116**



Acero D.E. 100mm D.B. 17mm A - 18.8mm V-Ranurada

NISSAN	FRONTIER	4 CIL, 2.4 L	2001 - 1999
NISSAN	XTERRA	4 CIL, 2.4 L	2001 - 2000

**36118**



Acero D.E. 80mm D.B. 17mm A - 25mm V-Ranurada

NISSAN	PATHFINDER	V-6, 3.0 L	1995 - 1995
--------	------------	------------	-------------

**36119**



Acero D.E. 102mm D.B. 17mm A - 26mm Lisa

TOYOTA	4 RUNNER	V-8, 4.7 L	2007 - 2003
TOYOTA	LAND CRUISER	V-8, 4.7 L	2006 - 2003
TOYOTA	SEQUOIA	V-8, 4.7 L	2008 - 2007



36136



Acero Pólen Pulverizada 0 costillas 72mm x 15mm x 20mm

FORD	KA	4 CIL, 1.6 L	2005	-	2005
------	----	--------------	------	---	------

36142



Acero D.E. 83.5mm D.B. 17mm A - 30mm Lisa

NISSAN	SENTRA	4 CIL, 1.6 L	2006	-	2006
--------	--------	--------------	------	---	------

36152



CHEVROLET	CHEVY PICK-UP	4 CIL 1.6 L	2002	-	2006
CHEVROLET	OPTRA	4 CIL 2.0 L	2006	-	2010
CHEVROLET	OPTRA	4 CIL 2.0 L	2008	-	2008
CHEVROLET	CHEVY POP	4 CIL 1.6 L	1994	-	2003
CHEVROLET	CHEVY JOY	4 CIL 1.6 L	1994	-	1996
CHEVROLET	CHEVY C2 SEDAN	4 CIL 1.6 L	2004	-	2008
CHEVROLET	CHEVY C2	4 CIL 1.6 L	2004	-	2008
CHEVROLET	CHEVY	4 CIL 1.6 L	2009	-	2010
CHEVROLET	CHEVY SWING	4 CIL 1.6 L	1994	-	2003

36156



Termoplástico D.E. 70mm D.B. 17mm A - 15mm Lisa

DODGE	NEON	4 CIL, 2.0 L	2006	-	2004
TOYOTA	CAMRY	4 CIL, 2.5 L	2010	-	2011
CHRYSLER	PT CRUISER	4 CIL, 2.4 L	2008	-	2010

36157



FORD	MUSTANG	V-8, 4.6 L	2008	-	2010
FORD	LOBO	V-8, 5.4 L	2007	-	2005
FORD	EXPLORER	V-8, 4.6 L	2007	-	2010
FORD	EXPLORER SPORT TRAC	V-8, 4.6 L	2007	-	2010
FORD	MUSTANG	V-8, 4.6 L	2007	-	2006
FORD	E SERIES VAN	V-8, 4.6 L	2008	-	2010
FORD	E SERIES VAN	V-8, 5.4 L	2008	-	2010
FORD	EXPEDITION	V-8, 5.4 L	2005	-	2010
FORD	F-150	V-8, 4.6 L	2008	-	2010
FORD	F-350 SUPER DUTY	V-8, 5.4 L	2007	-	2009
FORD	F-450 SUPER DUTY	V-10, 6.8 L	2007	-	2007
FORD	LOBO	V-8, 4.6 L	2008	-	2010
FORD	LOBO	V-8, 5.4 L	2008	-	2010
LINCOLN	AVIATOR	V-8, 4.6 L	2003	-	2005
LINCOLN	MARK LT	V-8, 5.4 L	2007	-	2008
LINCOLN	NAVIGATOR	V-8, 5.4 L	2006	-	2009
FORD	LOBO	V-8, 4.6 L	2006	-	2005

36168



MINI	COOPER	4 CIL, 1.6 L	2005	-	2008
------	--------	--------------	------	---	------

36169



Acero D.E. 60mm D.B. 12mm A - 21 25mm Lisa

CADILLAC	ESCALADE	V-8, 6.2 L	2007	-	2007
CHEVROLET	SILVERADO	V-8, 4.8 L	2008	-	2008
GMC	YUKON	V-8, 6.3 L	2008	-	2007
CHEVROLET	TAHOE	V-8, 6.3 L	2008	-	2008
CHEVROLET	TAHOE	V-8, 4.8 L	2007	-	2006



## Aplicación por Producto

GMC	SIERRA	V-8, 6.2 L	2008	-	2007
CADILLAC	ESCALADE	V-8 6.2 L	2008	-	2008
CHEVROLET	EXPRESS	V-8, 5.3 L	2008	-	2008
CHEVROLET	SILVERADO	V-8, 5.3 L	2008	-	2008
CHEVROLET	SUBURBAN	V-8, 6.0 L	2008	-	2008
CHEVROLET	EXPRESS	V-8, 6.0 L	2008	-	2008
HUMMER	H2	V-8, 6.2 L	2008	-	2008
CHEVROLET	AVALANCHE	V-8, 5.3 L	2008	-	2008
GMC	YUKON	V-8, 6.2 L	2008	-	2007
CHEVROLET	SUBURBAN	V-8, 5.3 L	2008	-	2008
CHEVROLET	AVALANCHE	V-8, 5.3 L	2007	-	2007

36201



CHEVROLET	UPLANDER	V-6, 3.9 L	2008	-	2009
-----------	----------	------------	------	---	------

36222



NISSAN	TITAN	V-8, 5.6 L	2008	-	2009
NISSAN	PATHFINDER	V-6, 4.0 L	2008	-	2010
NISSAN	ARMADA	V-8, 5.6 L	2006	-	2009

36234



FORD	F-550 SUPER DUTY	V-8, 6.4 L DIESEL	2008	-	2010
FORD	F-450 SUPER DUTY	V-8, 6.4 L DIESEL	2008	-	2010
FORD	F-250 SUPER DUTY	V-8, 6.4 L DIESEL	2008	-	2010

36263



MAZDA	CX-7	4 CIL, 2.3 L	2006	-	2008
-------	------	--------------	------	---	------

36173



TOYOTA	TACOMA	V-6, 4.0 L	2009	-	2010
TOYOTA	HIGHLANDER	V-6, 3.5 L	2008	-	2010
TOYOTA	CAMRY	V-6, 3.5 L	2009	-	2011
TOYOTA	RAV 4	V-6, 3.5 L	2008	-	2010
TOYOTA	SIENNA	V-6, 3.5 L	2011	-	2010

36174



TOYOTA	TACOMA	V-6, 4.0 L	2009	-	2010
--------	--------	------------	------	---	------

36193



CHEVROLET	MALIBU	4 CIL, 2.4 L	2008	-	2010
CHEVROLET	HHR	4 CIL, 2.4 L	2008	-	2010
CHEVROLET	CAPTIVA	4 CIL, 2.4 L	2008	-	2010

36271



<table border="0"> <tr> <td>MITSUBISHI</td> <td>ECLIPSE</td> <td>V-6, 3.8 L</td> <td>2007 - 2008</td> </tr> </table>	MITSUBISHI	ECLIPSE	V-6, 3.8 L	2007 - 2008
MITSUBISHI	ECLIPSE	V-6, 3.8 L	2007 - 2008	

36301



<table border="0"> <tr> <td>HUMMER</td> <td>H3</td> <td>5 CIL, 3.7 L</td> <td>2008 - 2010</td> </tr> <tr> <td>CHEVROLET</td> <td>COLORADO</td> <td>4 CIL, 2.9 L</td> <td>2008 - 2010</td> </tr> <tr> <td>GMC</td> <td>CANYON</td> <td>5 CIL, 3.7 L</td> <td>2009 - 2010</td> </tr> <tr> <td>CHEVROLET</td> <td>COLORADO</td> <td>5 CIL, 3.7 L</td> <td>2008 - 2010</td> </tr> </table>	HUMMER	H3	5 CIL, 3.7 L	2008 - 2010	CHEVROLET	COLORADO	4 CIL, 2.9 L	2008 - 2010	GMC	CANYON	5 CIL, 3.7 L	2009 - 2010	CHEVROLET	COLORADO	5 CIL, 3.7 L	2008 - 2010
HUMMER	H3	5 CIL, 3.7 L	2008 - 2010													
CHEVROLET	COLORADO	4 CIL, 2.9 L	2008 - 2010													
GMC	CANYON	5 CIL, 3.7 L	2009 - 2010													
CHEVROLET	COLORADO	5 CIL, 3.7 L	2008 - 2010													

36299



CHEVROLET	SUBURBAN	V-8, 6.0 L	2008 - 2010
GMC	SIERRA	V-8, 5.3 L	2009 - 2010
CADILLAC	ESCALADE	V-8 6.2 L	2008 - 2010
CHEVROLET	SILVERADO	V-6, 4.3 L	2008 - 2010
HUMMER	H2	V-8, 6.2 L	2008 - 2010
CHEVROLET	SILVERADO	V-8, 4.8 L	2008 - 2010
CHEVROLET	SILVERADO	V-8, 5.3 L	2008 - 2010
CHEVROLET	TAHOE	V-8, 5.3 L	2008 - 2010
CHEVROLET	SUBURBAN	V-8, 5.3 L	2008 - 2010
GMC	YUKON	V-8, 6.2 L	2009 - 2010
CHEVROLET	EXPRESS	V-8, 5.3 L	2008 - 2010
CHEVROLET	EXPRESS	V-8, 6.0 L	2008 - 2010
CHEVROLET	AVALANCHE	V-8, 5.3 L	2008 - 2010
GMC	SIERRA	V-8, 6.2 L	2009 - 2010
CHEVROLET	EXPRESS CARGO VAN	V-6, 4.3 L	2008 - 2010

36305



<table border="0"> <tr> <td>NISSAN</td> <td>370Z</td> <td>V-6, 3.7 L</td> <td>2009 - 2009</td> </tr> <tr> <td>NISSAN</td> <td>350Z</td> <td>V-6, 3.5 L</td> <td>2007 - 2009</td> </tr> </table>	NISSAN	370Z	V-6, 3.7 L	2009 - 2009	NISSAN	350Z	V-6, 3.5 L	2007 - 2009
NISSAN	370Z	V-6, 3.7 L	2009 - 2009					
NISSAN	350Z	V-6, 3.5 L	2007 - 2009					

36306



<table border="0"> <tr> <td>NISSAN</td> <td>350Z</td> <td>V-6, 3.5 L</td> <td>2007 - 2009</td> </tr> </table>	NISSAN	350Z	V-6, 3.5 L	2007 - 2009
NISSAN	350Z	V-6, 3.5 L	2007 - 2009	

36300



<table border="0"> <tr> <td>AUDI</td> <td>A3</td> <td>V-6, 3.2 L</td> <td>2007 - 2008</td> </tr> </table>	AUDI	A3	V-6, 3.2 L	2007 - 2008
AUDI	A3	V-6, 3.2 L	2007 - 2008	

36313



<table border="0"> <tr> <td>CHRYSLER</td> <td>300 C</td> <td>V-6, 3.5 L</td> <td>2007 - 2009</td> </tr> <tr> <td>CHRYSLER</td> <td>TOWN &amp; COUNTRY</td> <td>V6, 4.0 L</td> <td>2008 - 2010</td> </tr> <tr> <td>JEEP</td> <td>GRAND CHEROKEE</td> <td>V-8, 5.7 L</td> <td>2008 - 2009</td> </tr> <tr> <td>DODGE</td> <td>CHARGER</td> <td>V-6, 3.5 L</td> <td>2009 - 2009</td> </tr> <tr> <td>DODGE</td> <td>JOURNEY</td> <td>V-6, 3.5 L</td> <td>2009 - 2010</td> </tr> <tr> <td>DODGE</td> <td>CHARGER</td> <td>V-8, 5.7 L</td> <td>2009 - 2009</td> </tr> <tr> <td>JEEP</td> <td>COMMANDER</td> <td>V-8, 5.7 L</td> <td>2009 - 2009</td> </tr> </table>	CHRYSLER	300 C	V-6, 3.5 L	2007 - 2009	CHRYSLER	TOWN & COUNTRY	V6, 4.0 L	2008 - 2010	JEEP	GRAND CHEROKEE	V-8, 5.7 L	2008 - 2009	DODGE	CHARGER	V-6, 3.5 L	2009 - 2009	DODGE	JOURNEY	V-6, 3.5 L	2009 - 2010	DODGE	CHARGER	V-8, 5.7 L	2009 - 2009	JEEP	COMMANDER	V-8, 5.7 L	2009 - 2009
CHRYSLER	300 C	V-6, 3.5 L	2007 - 2009																									
CHRYSLER	TOWN & COUNTRY	V6, 4.0 L	2008 - 2010																									
JEEP	GRAND CHEROKEE	V-8, 5.7 L	2008 - 2009																									
DODGE	CHARGER	V-6, 3.5 L	2009 - 2009																									
DODGE	JOURNEY	V-6, 3.5 L	2009 - 2010																									
DODGE	CHARGER	V-8, 5.7 L	2009 - 2009																									
JEEP	COMMANDER	V-8, 5.7 L	2009 - 2009																									

## Aplicación por Producto

DODGE	RAM 2500	V-8, 5.7 L	2009	-	2009
VOLKSWAGEN	ROUTAN	V-6, 3.8 L	2009	-	2010
JEEP	GRAND CHEROKEE	V-8, 6.1 L	2008	-	2009

### 37013P

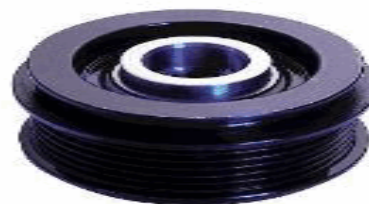

VOLKSWAGEN	JETTA	4 CIL, 1.8 L	2005	-	2000
AUDI	A3	V-6, 3.2 L	2007	-	2008
VOLKSWAGEN	BEETLE	4 CIL, 2.0 L	2003	-	1998
VOLKSWAGEN	JETTA	4 CIL, 2.0 L	2005	-	1999
AUDI	A3	4 CIL, 2.0 L	2006	-	2009
VOLKSWAGEN	GOLF	4 CIL, 1.8 L	2001	-	2000
VOLKSWAGEN	GOLF	4 CIL, 2.0 L	2003	-	2000
VOLKSWAGEN	BEETLE	4 CIL, 1.8 L	2003	-	1999
AUDI	TT	4 CIL, 1.8 L	2003	-	2000
VOLKSWAGEN	JETTA	4 CIL, 1.9 L DIESE	2004	-	2000

### 37014P

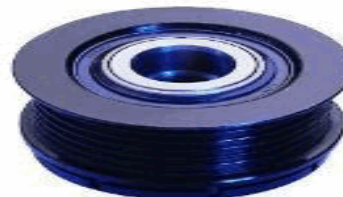

PORSCHE	BOXSTER	6 CIL, 3.2 L	2006	-	2000
PORSCHE	911	6 CIL, 3.4 L	2000	-	2000
PORSCHE	BOXSTER	6 CIL, 2.7 L	2006	-	2000

### 37015P



TOYOTA	COROLLA	4 CIL, 1.8 L	2009	-	2010
TOYOTA	MATRIX	4 CIL, 1.8 L	2009	-	2010

### 36315



DODGE	RAM 4000	V-6, 6.7 L DIESEL	2008	-	2009
DODGE	RAM 4000	V-6, 5.9 L DIESEL	2008	-	2008

### 36320



ACURA	TSX	4 CIL, 2.4 L	2009	-	2009
-------	-----	--------------	------	---	------

### 37008P



ACURA	RL	V-6, 3.5 L	2008	-	2006
ACURA	MDX	V-6, 3.5 L	2006	-	2006
ACURA	MDX	V-6, 3.7 L	2008	-	2007
ACURA	TL	V-6, 3.2 L	2007	-	2006

### 37010P



VOLKSWAGEN	JETTA	4 CIL, 1.9 L DIESE	2002	-	2000
------------	-------	--------------------	------	---	------

## Aplicación por Producto

### 37017P



TOYOTA	MATRIX	4 CIL, 2.4 L	2009 - 2010
TOYOTA	RAV 4	4 CIL, 2.4 L	2007 - 2008
TOYOTA	CAMRY	4 CIL, 2.4 L	2007 - 2009
TOYOTA	COROLLA	4 CIL, 2.4 L	2009 - 2010

### 37018P



DODGE	AVENGER	4 CIL, 2.4 L	2007 - 2009
JEEP	PATRIOT	4 CIL, 2.4 L	2009 - 2008
DODGE	AVENGER	4 CIL, 2.0 L	2007 - 2009
DODGE	CALIBER	4 CIL, 2.4 L	2007 - 2009
JEEP	COMPASS	4 CIL, 2.4 L	2009 - 2008

### 37026P

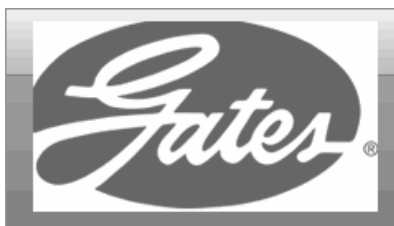

TOYOTA	HIGHLANDER	V-6, 3.5 L	2008 - 2010
TOYOTA	SIENNA	V-6, 3.5 L	2011 - 2010
TOYOTA	CAMRY	V-6, 3.5 L	2009 - 2011
TOYOTA	RAV 4	V-6, 3.5 L	2008 - 2010

### 38001



Acero D.E. 90mm D.B. 17mm A - 30mm Lisa

CHEVROLET	IMPALA	V-6, 3.8 L	2005 - 2005
-----------	--------	------------	-------------

GMC	YUKON	V-8, 5.3 L	2008 - 2007
HONDA	ODYSSEY	V-6, 3.5 L	2002 - 1999
CHEVROLET	IMPALA	V-6, 3.4 L	2004 - 2000
CHEVROLET	IMPALA	V-6, 3.4 L	2005 - 2003
CHEVROLET	LUMINA	V-6, 3.1 L	1998 - 1998
HONDA	ACCORD	V-6, 3.0 L	2002 - 1998
CHEVROLET	AVALANCHE	V-8, 5.3 L	2006 - 2005
CHEVROLET	EXPRESS CARGO VAN	V-6, 4.3 L	2006 - 2004
CHEVROLET	MONTE CARLO	V-6, 3.4 L	2005 - 2004
GMC	YUKON	V-8, 6.2 L	2008 - 2007
GMC	SIERRA	V-8, 6.2 L	2008 - 2007
CADILLAC	ESCALADE	V-8, 6.0 L	2006 - 2002
LINCOLN	NAVIGATOR	V-8, 5.4 L	2004 - 2003
MERCURY	MYSTIQUE	4 CIL, 2.0 L	1997 - 1995
MERCURY	MYSTIQUE	V-6, 2.5 L	2000 - 1995
MERCURY	SABLE / TAURUS	V-6, 3.0 L	2004 - 1997
CHEVROLET	CENTURY	V-6, 3.1 L	1999 - 1998
LINCOLN	AVIATOR	V-8, 4.6 L	2003 - 2005
CADILLAC	ESCALADE	V-8, 6.2 L	2007 - 2007
LINCOLN	MARK LT	V-8, 5.4 L	2007 - 2008
CADILLAC	ESCALADE	V-8, 5.7 L	2000 - 1999
CADILLAC	ESCALADE	V-8, 5.3 L	2004 - 2002
CADILLAC	SEVILLE	V-8, 4.6 L	1997 - 1994
CADILLAC	EL DORADO	V-8, 4.6 L	1997 - 1994
PONTIAC	FIREBIRD TRANS AM	V-8, 5.7 L	1997 - 1997
PONTIAC	GRAND PRIX	V-6, 3.1 L	2002 - 1998
CHEVROLET	CAMARO Z28	V-8, 5.7 L	1997 - 1996
JEEP	WRANGLER	4 CIL, 2.5 L	2000 - 1999
CHEVROLET	EXPRESS	V-8, 8.1 L	2002 - 2001
CHEVROLET	EXPRESS	V-8, 7.4 L	2000 - 1996
CHEVROLET	EXPRESS	V-8, 6.0 L	2007 - 2003
CHEVROLET	EXPRESS	V-8, 5.0 L	2002 - 1996
JAGUAR	S-TYPE	V-8, 4.0 L	2005 - 2000
JEEP	GRAND CHEROKEE	V-6, 3.7 L	2007 - 2005
LINCOLN	NAVIGATOR	V-8, 5.4 L	2008 - 2009
JEEP	LIBERTY	V-6, 3.7 L	2006 - 2002
CHEVROLET	EXPRESS	V-8, 5.3 L	2007 - 2003
LINCOLN	LS	V-6, 3.0 L	2001 - 2000
LINCOLN	LS	V-8, 3.9 L	2002 - 2000
FORD	WINDSTAR	V-6, 3.8 L	2003 - 1998
CHEVROLET	EXPRESS	V-8, 5.7 L	2002 - 1996
FORD	F SERIES PICKUP	V-6, 4.2 L	2002 - 1998
HUMMER	H2	V-8, 6.0 L	2007 - 2005
JEEP	GRAND CHEROKEE	V-8, 4.7 L	2007 - 1999
PONTIAC	GRAND PRIX	V-6, 3.8 L	2005 - 2003
DODGE	NITRO	V-6, 3.7 L	2008 - 2007
CHEVROLET	C y K SERIES PICKUP	V-8, 5.7 L	2000 - 1993
CHEVROLET	C y K SERIES PICKUP	V-8, 5.0 L	1999 - 1997
DODGE	RAM SERIES PICKUP	V-6, 3.7 L	2003 - 2002
FORD	CONTOUR	4 CIL, 2.0 L	1997 - 1995
FORD	CONTOUR	V-6, 2.5 L	2000 - 1996
FORD	ESCORT	4 CIL, 1.9 L	1996 - 1994

## Aplicación por Producto

FORD	ESCORT	4 CIL, 2.0 L	2002	-	1997
FORD	F SERIES PICKUP	V-8, 7.5 L	1997	-	1997
CHEVROLET	BLAZER	V-6, 4.3 L	2004	-	1993
DODGE	DAKOTA	V-6, 3.7 L	2008	-	2007
FORD	MUSTANG	V-6, 4.0 L	2008	-	2010
FORD	MUSTANG	V-6, 4.0 L	2007	-	2005
FORD	MUSTANG	V-8, 4.6 L	2005	-	2005
CHEVROLET	BLAZER	V-6, 4.3 L	2005	-	2005
CHEVROLET	SILVERADO	V-8, 4.8 L	2007	-	2001
CHEVROLET	AVALANCHE	V-8, 8.1 L	2002	-	2002
FORD	MUSTANG	V-8, 4.6 L	2008	-	2010
FORD	MUSTANG	V-8, 4.6 L	2007	-	2003
CHEVROLET	C y K SERIES PICKUP	V-6, 4.3 L	1998	-	1995
CHEVROLET	TRAILBLAZER	V-8, 5.3 L	2005	-	2005
CHEVROLET	SILVERADO	V-8, 8.1 L	2007	-	2001
CHEVROLET	SUBURBAN	V-8, 5.3 L	2007	-	2000
CHEVROLET	SUBURBAN	V-8, 5.7 L	1999	-	1993
CHEVROLET	SUBURBAN	V-8, 6.0 L	2007	-	2000
CHEVROLET	SUBURBAN	V-8, 7.4 L	1999	-	1993
CHEVROLET	SUBURBAN	V-8, 8.1 L	2006	-	2001
CHEVROLET	TAHOE	V-8, 4.8 L	2007	-	2006
CHEVROLET	TAHOE	V-8, 5.3 L	2007	-	2006
DODGE	DURANGO	V-8, 4.7 L	2006	-	2000
CHEVROLET	C-35	V-8, 5.7 L	1993	-	1993
DODGE	DURANGO	V-6, 3.7 L	2005	-	2004
CHEVROLET	TRAILBLAZER	V-8, 5.3 L	2007	-	2003
CHEVROLET	TRAILBLAZER	V-8, 6.0 L	2006	-	2006
CHEVROLET	VENTURE	V-6, 3.4 L	1998	-	1998
CHEVROLET	C-2500	V-8, 5.7 L	2000	-	1993
CHEVROLET	SILVERADO	V-8, 5.3 L	2007	-	2000
CHRYSLER	VOYAGER	V-6, 3.3 L	2000	-	2000
CHEVROLET	C y K SERIES PICKUP	V-8, 8.1 L	2002	-	2001
CHEVROLET	C y K SERIES PICKUP	V-8, 7.4 L	2000	-	1999
FORD	AEROSTAR	V-6, 4.0 L	1997	-	1996
CHEVROLET	C-3500	V-8, 5.7 L	2000	-	1994
CHEVROLET	EXPRESS CARGO VAN	V-6, 4.3 L	2007	-	2007
FORD	THUNDERBIRD	V-6, 3.8 L	1994	-	1994
FORD	F-350 SUPER DUTY	V-8, 5.4 L	2007	-	2010
FORD	F-350 SUPER DUTY	V-8, 5.4 L	2006	-	2002
FORD	F-450 SUPER DUTY	V-10, 6.8 L	2007	-	2010
FORD	F-450 SUPER DUTY	V-8, 7.5 L	1997	-	1997
FORD	F-550 SUPER DUTY	V-10, 6.8 L	2008	-	2010
CHEVROLET	S-10	V-6, 4.3 L	2002	-	1993
CHEVROLET	S-10	4 CIL, 2.2 L	1997	-	1994
FORD	F-150	V-6, 4.2 L	2006	-	2003
FORD	LOBO	V-8, 4.6 L	2006	-	2005
FORD	F-150	V-6, 4.2 L	2008	-	2008
CHEVROLET	EXPRESS	V-6, 4.3 L	2003	-	1996
FORD	LOBO	V-8, 5.4 L	2008	-	2010
FORD	LOBO	V-8, 5.4 L	2007	-	2005
FORD	RANGER	4 CIL, 2.3 L	2004	-	2002
FORD	RANGER	4 CIL, 2.5 L	2001	-	1998

FORD	RANGER	V-6, 3.0 L	2002	-	1999
FORD	RANGER	V-6, 4.0 L	2001	-	1999
FORD	SUPER DUTY PICKUP	V-8, 5.4 L	2003	-	2002
FORD	SUPER DUTY VAN	V-6, 4.2 L	2001	-	2001
FORD	LOBO	V-8, 4.6 L	2008	-	2010
FORD	EXPLORER	V-6, 4.0 L	2007	-	1995
FORD	SUPER DUTY VAN	V-8, 4.6 L	2003	-	2003
FORD	E SERIES VAN	V-6, 4.2 L	2003	-	1997
FORD	E SERIES VAN	V-8, 4.6 L	2008	-	2010
FORD	E SERIES VAN	V-8, 4.6 L	2006	-	2002
FORD	E SERIES VAN	V-8, 5.4 L	2008	-	2010
FORD	E SERIES VAN	V-8, 5.4 L	2007	-	2002
FORD	EXCURSION	V-8, 4.6 L	2003	-	2003
FORD	EXPEDITION	V-8, 4.6 L	2004	-	2003
FORD	F-150	V-8, 4.6 L	2008	-	2010
FORD	EXPLORER	V-6, 4.0 L	2007	-	2010
CHEVROLET	AVALANCHE	V-8, 5.3 L	2007	-	2002
FORD	EXPLORER	V-8, 4.6 L	2007	-	2002
FORD	EXPLORER	V-8, 5.0 L	2001	-	1998
FORD	EXPLORER SPORT TRAC	V-6, 4.0 L	2007	-	2010
FORD	EXPLORER SPORT TRAC	V-6, 4.0 L	2006	-	2001
CHEVROLET	SILVERADO	V-6, 4.3 L	2007	-	1999
FORD	EXPLORER SPORT TRAC	V-8, 4.6 L	2007	-	2010
CHEVROLET	SILVERADO	V-8, 6.0 L	2007	-	2000
FORD	F SERIES PICKUP	V-8, 5.4 L	2002	-	2002
FORD	EXPEDITION	V-8, 5.4 L	2005	-	2010
FORD	EXPEDITION	V-8, 5.4 L	2003	-	2003
TOYOTA	4 RUNNER	V-8, 4.7 L	2004	-	2003
FORD	EXPLORER	V-8, 4.6 L	2007	-	2010

### 38002



Acero D.E. 100mm D.B. 17mm A - 30.5mm Lisa

FORD	EXPLORER	V-8, 5.0 L	2001	-	1998
FORD	AEROSTAR	V-6, 3.0 L	1997	-	1994
FORD	AEROSTAR	V-6, 4.0 L	1995	-	1993

### 38003



Acero D.E. 94.5mm D.B. 12mm A - 16.5mm V-Ranurada

DODGE	INTREPID	V-6, 3.3 L	1997	-	1994
-------	----------	------------	------	---	------



## Aplicación por Producto

DODGE	SHADOW	4 CIL, 2.2 L	1994	-	1994
DODGE	SHADOW	4 CIL, 2.5 L	1995	-	1993
DODGE	SPIRIT	4 CIL, 2.5 L	1994	-	1993
DODGE	SPIRIT	V-6, 3.0 L	1994	-	1994
CHRYSLER	CONCORDE	V-6, 3.3 L	1996	-	1993
CHRYSLER	CONCORDE	V-6, 3.5 L	1994	-	1993
DODGE	CARAVAN	4 CIL, 2.5 L	1995	-	1995
CHRYSLER	LEBARON	V-6, 3.0 L	1995	-	1993
DODGE	CARAVAN	V-6, 3.0 L	1995	-	1995
CHRYSLER	LEBARON	4 CIL, 2.5 L	1994	-	1993

### 38004

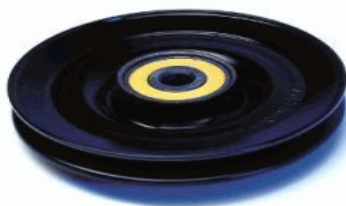

Acero D.E. 118mm D.B. 12mm A - 16.5mm V-Ranurada

DODGE	INTREPID	V-6, 3.5 L	1997	-	1997
-------	----------	------------	------	---	------

### 38005



Acero D.E. 82mm D.B. 17mm A - 30.5mm Lisa

NISSAN	XTERRA	V-6, 3.3 L	2001	-	2000
OLDSMOBILE	SILHOUETTE	V-6, 3.8 L	1995	-	1995
FORD	WINDSTAR	V-6, 3.8 L	1997	-	1996
FORD	WINDSTAR	V-6, 3.0 L	1998	-	1998
NISSAN	FRONTIER	V-6, 3.3 L	2001	-	1999

### 38006



Acero D.E. 76mm D.B. 17mm A - 30.5mm Lisa

PONTIAC	AZTEK	V-6, 3.4 L	2004	-	2001
CADILLAC	EL DORADO	V-8, 4.6 L	2001	-	1998
FORD	THUNDERBIRD	V-8, 4.6 L	1997	-	1994
CADILLAC	EL DORADO	V-8, 4.6 L	2002	-	1994
FORD	CONTOUR	4 CIL, 2.0 L	1998	-	1998
FORD	EXPEDITION	V-8, 5.4 L	2003	-	2003
CHEVROLET	C y K SERIES PICKUP	V-8, 5.7 L	1995	-	1993

FORD	F-550 SUPER DUTY	V-10, 6.8 L	2008	-	2010
FORD	EXPEDITION	V-8, 5.4 L	2005	-	2010
CADILLAC	DTS	V-8, 4.6 L	2007	-	2006
CHEVROLET	C-3500	V-8, 5.7 L	1995	-	1994
OLDSMOBILE	EIGHTY EIGHT	V-6, 3.8 L	1999	-	1999
MAZDA	MAZDA 3	4 CIL, 2.3 L	2010	-	2010
FORD	ESCAPE	V-6, 3.0 L	2008	-	2009
FORD	ESCAPE	V-6, 3.0 L	2004	-	2001
FORD	FUSION	V-6, 3.0 L	2008	-	2007
FORD	RANGER	4 CIL, 2.3 L	2004	-	1995
FORD	AEROSTAR	V-6, 3.0 L	1997	-	1995
PONTIAC	AZTEK	V-6, 3.4 L	2005	-	2005
FORD	RANGER	V-6, 3.0 L	2002	-	1996
FORD	ZX2	4 CIL, 2.0 L	2003	-	2003
FORD	EXPEDITION	V-8, 4.6 L	2003	-	2003
CHEVROLET	SUBURBAN	V-8, 5.7 L	1995	-	1993
FORD	TOPAZ	4 CIL, 2.3 L	1994	-	1994
FORD	RANGER	4 CIL, 2.5 L	2001	-	1998
FORD	F-450 SUPER DUTY	V-10, 6.8 L	2008	-	2010
CHEVROLET	C y K SERIES PICKUP	V-8, 6.5 L	2002	-	1999
MERCURY	MYSTIQUE	4 CIL, 2.0 L	1998	-	1998
FORD	F-350 SUPER DUTY	V-8, 5.0 L	1996	-	1993
CHEVROLET	SILVERADO	V-8, 6.6 L	2001	-	2001
MERCURY	GRAND MARQUIS	V-8, 4.6 L	2005	-	1993
FORD	F SERIES PICKUP	V-8, 5.0 L	1996	-	1995
MERCURY	MILAN	V-6, 3.0 L	2009	-	2009
FORD	CONTOUR	V-6, 2.5 L	2000	-	1995
MERCURY	SABLE / TAURUS	V-6, 3.8 L	1994	-	1993
CHEVROLET	EQUINOX	V-6, 3.4 L	2007	-	2005
CADILLAC	SRX	V-8, 4.6 L	2004	-	2004
FORD	MUSTANG	V-6, 3.8 L	2001	-	1998
CHEVROLET	CAMARO Z28	V-8, 5.7 L	2002	-	1998
CHEVROLET	C y K SERIES PICKUP	V-6, 4.3 L	1995	-	1995
FORD	F SERIES PICKUP	V-8, 5.8 L	1997	-	1995
MERCURY	MARINER	V-6, 3.0 L	2008	-	2009
MERCURY	MILAN	V-6, 3.0 L	2007	-	2006
MERCURY	SABLE / TAURUS	V-6, 3.0 L	2005	-	1996
FORD	CROWN VICTORIA	V-8, 4.6 L	2004	-	1996
FORD	F-250	V-8, 5.0 L	1996	-	1993
FORD	EXPLORER	V-8, 4.6 L	2007	-	2003
FORD	THUNDERBIRD	V-6, 3.8 L	1994	-	1994
FORD	FUSION	V-6, 3.0 L	2009	-	2009
MERCURY	MYSTIQUE	V-6, 2.5 L	2000	-	1995
CHEVROLET	BLAZER	V-6, 4.3 L	1995	-	1993
FORD	MUSTANG	V-8, 5.0 L	1995	-	1994
FORD	MUSTANG	V-8, 4.6 L	2008	-	2010
PONTIAC	MONTANA	V-6, 3.9 L	2008	-	2006
FORD	F-350 SUPER DUTY	V-8, 5.8 L	1997	-	1993
FORD	MUSTANG	V-8, 4.6 L	2002	-	1996
FORD	ESCORT	4 CIL, 2.0 L	2002	-	1998
FORD	F-350 SUPER DUTY	V-8, 5.4 L	2010	-	2010
CADILLAC	SEVILLE	V-8, 4.6 L	2004	-	1994



## Aplicación por Producto

FORD	EXPLORER	V-8, 5.0 L	2001	-	1998
CHEVROLET	C-2500	V-8, 5.7 L	1995	-	1993
CHEVROLET	UPLANDER	V-6, 3.9 L	2008	-	2009
MAZDA	MAZDA 6	4 CIL, 2.3 L	2008	-	2008
JEEP	WRANGLER	4 CIL, 2.4 L	2006	-	2003
CHEVROLET	MALIBU	V-6, 3.5 L	2005	-	2005
CHEVROLET	UPLANDER	V-6, 3.5 L	2007	-	2006
PONTIAC	G6	V-6, 3.9 L	2006	-	2006
CHEVROLET	S-10	V-6, 4.3 L	1995	-	1994
CHEVROLET	MALIBU	V-6, 3.1 L	2003	-	1997
LINCOLN	CONTINENTAL	V-8, 4.6 L	2002	-	1995
FORD	E SERIES VAN	V-8, 5.4 L	2008	-	2010
FORD	E SERIES VAN	V-8, 5.4 L	2007	-	2004
LINCOLN	MARK VIII	V-8, 4.6 L	1996	-	1994
PONTIAC	FIREBIRD TRANS AM	V-8, 5.7 L	2002	-	1998
FORD	WINDSTAR	V-6, 3.8 L	1995	-	1995
CHEVROLET	MALIBU	V-6, 3.5 L	2007	-	2004
PONTIAC	GRAND AM	V-6, 3.4 L	2004	-	1999
CHEVROLET	CORVETTE	V-8, 5.7 L	2004	-	1997
CHEVROLET	C-35	V-8, 5.7 L	1993	-	1993
PONTIAC	GRAND PRIX	V-6, 3.8 L	2005	-	1997
CHEVROLET	CUTLASS	V-6, 3.1 L	1998	-	1997
CHEVROLET	TRAILBLAZER	6 CIL, 4.2 L	2005	-	2005
CHEVROLET	UPLANDER	V-6, 3.5 L	2005	-	2005
CHEVROLET	IMPALA	V-6, 3.8 L	2005	-	2005
PONTIAC	G6	V-6, 3.5 L	2008	-	2007
PONTIAC	GRAND AM	V-6, 3.4 L	2005	-	2005
FORD	E SERIES VAN	V-8, 4.6 L	2006	-	2004
CHEVROLET	TRAILBLAZER	6 CIL, 4.2 L	2007	-	2002
CHEVROLET	IMPALA	V-6, 3.8 L	2004	-	2000
CHEVROLET	LUMINA	V-6, 3.8 L	1998	-	1998
CHEVROLET	EXPRESS	V-8, 8.1 L	2002	-	2001
FORD	E SERIES VAN	V-8, 4.6 L	2008	-	2010
FORD	ECOSPORT	4 CIL, 2.0 L	2005	-	2004
LINCOLN	AVIATOR	V-8, 4.6 L	2003	-	2005
CHEVROLET	VENTURE	V-6, 3.4 L	2004	-	1999
CHEVROLET	C y K SERIES PICKUP	V-8, 8.1 L	2002	-	2001
CHEVROLET	UPLANDER	V-6, 3.9 L	2007	-	2006
CADILLAC	DEVILLE	V-8, 4.6 L	2005	-	1998
FORD	ECOSPORT	4 CIL, 2.0 L	2008	-	2010
CHEVROLET	MONTE CARLO	V-6, 3.8 L	2005	-	2004
CHEVROLET	VENTURE	V-6, 3.4 L	2005	-	2005
FORD	ECOSPORT	4 CIL, 2.0 L	2007	-	2006
LINCOLN	MARK LT	V-8, 5.4 L	2007	-	2008
PONTIAC	BONNEVILLE	V-6, 3.8 L	2005	-	1994
LINCOLN	NAVIGATOR	V-8, 5.4 L	2008	-	2009
CHEVROLET	EXPRESS	V-8, 6.5 L	2002	-	1999
LINCOLN	TOWN CAR	V-8, 4.6 L	2006	-	1993
LINCOLN	NAVIGATOR	V-8, 5.4 L	2003	-	2003
FORD	WINDSTAR	V-6, 3.0 L	1998	-	1998

### 38007

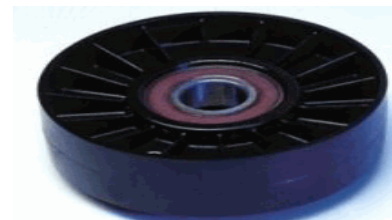

Termoplástico D.E. 90mm D.B. 17mm A - 25.5mm Lisa

FORD	F-350 SUPER DUTY	V-8, 5.8 L	1997	-	1993
PONTIAC	GRAND AM	V-6, 3.1 L	1997	-	1997
MERCURY	COUGAR XR7	V-6, 3.8 L	1994	-	1993
FORD	F SERIES PICKUP	V-8, 5.0 L	1996	-	1995
CHEVROLET	IMPALA	V-6, 3.8 L	2005	-	2005
CHEVROLET	VENTURE	V-6, 3.4 L	1997	-	1997
FORD	SUPER DUTY VAN	V-6, 4.2 L	2001	-	2001
OLDSMOBILE	EIGHTY EIGHT	V-6, 3.8 L	1999	-	1999
PONTIAC	GRAND PRIX	V-6, 3.1 L	1997	-	1997
FORD	F SERIES PICKUP	V-6, 4.2 L	2002	-	1998
CHEVROLET	CUTLASS	V-6, 3.1 L	1996	-	1993
FORD	F SERIES PICKUP	V-8, 5.8 L	1997	-	1995
FORD	F-250	V-8, 5.0 L	1996	-	1993
PONTIAC	GRAND PRIX	V-6, 3.8 L	2002	-	1997
FORD	F-150	V-6, 4.2 L	2007	-	1998
CHEVROLET	CAVALIER	V-6, 3.1 L	1994	-	1993
FORD	THUNDERBIRD	V-6, 3.8 L	1994	-	1994
FORD	F-350 SUPER DUTY	V-8, 5.0 L	1996	-	1993
CHEVROLET	LUMINA	V-6, 3.1 L	1997	-	1996
CADILLAC	DEVILLE	V-8, 4.9 L	1994	-	1993
CHEVROLET	IMPALA	V-6, 3.8 L	2004	-	2004
FORD	E SERIES VAN	V-6, 4.2 L	2003	-	1997
OLDSMOBILE	SILHOUETTE	V-6, 3.4 L	1996	-	1996
CHEVROLET	CENTURY	V-6, 3.1 L	1997	-	1994
PONTIAC	BONNEVILLE	V-6, 3.8 L	2003	-	1996

### 38008

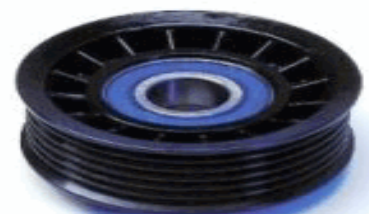

Termoplástico D.E. 70mm D.B. 17mm A - 34.5mm V-Ran

FORD	CONTOUR	4 CIL, 2.0 L	2000	-	1998
CHEVROLET	EXPRESS	V-8, 5.0 L	2002	-	1996
BMW	Z4	6 CIL, 2.5 L	2005	-	2003
MERCURY	MYSTIQUE	4 CIL, 2.0 L	2000	-	1998
HUMMER	H1	V-8, 6.6 L	2007	-	2006
CHEVROLET	EXPRESS CARGO VAN	V-6, 4.3 L	2007	-	2007
CHEVROLET	SILVERADO	V-6, 4.3 L	2008	-	2010
CHEVROLET	EXPRESS CARGO VAN	V-6, 4.3 L	2008	-	2010

## Aplicación por Producto

CHEVROLET	EXPRESS	V-8, 5.7 L	2002	-	1996
CHEVROLET	BLAZER	V-6, 4.3 L	2004	-	1996
CHEVROLET	CORVETTE	V-8, 5.7 L	2004	-	1997
CHEVROLET	EXPRESS CARGO VAN	V-6, 4.3 L	2006	-	2004
CHEVROLET	CORVETTE	V-8, 6.0 L	2007	-	2005
FORD	WINDSTAR	V-6, 3.8 L	2003	-	1998
CHEVROLET	SILVERADO	V-6, 4.3 L	2001	-	1999
FORD	FOCUS	4 CIL, 2.0 L	2003	-	2000
FORD	FOCUS	4 CIL, 2.0 L	2002	-	2002
CHEVROLET	EXPRESS	V-8, 8.1 L	2002	-	2001
CHEVROLET	SILVERADO	V-8, 6.6 L	2007	-	2001
MAZDA	MAZDA 6	4 CIL, 2.3 L	2007	-	2006
FORD	RANGER	V-6, 4.0 L	2001	-	1999
CHEVROLET	CAMARO Z28	V-8, 5.7 L	2002	-	1998
CHEVROLET	S-10	V-6, 4.3 L	2001	-	1996
MERCURY	MILAN	V-6, 3.0 L	2009	-	2009
CHEVROLET	EXPRESS	V-8, 7.4 L	2000	-	1996
MERCURY	MILAN	V-6, 3.0 L	2007	-	2006
MAZDA	MX-5 MIATA	4 CIL, 2.0 L	2007	-	2006
CHEVROLET	EXPRESS	V-6, 4.3 L	2003	-	1996
CHEVROLET	BLAZER	V-6, 4.3 L	2005	-	2005
BMW	Z4	6 CIL, 3.0 L	2005	-	2003
PONTIAC	FIREBIRD TRANS AM	V-8, 5.7 L	2002	-	1998
CHEVROLET	SUBURBAN	V-8, 7.4 L	1999	-	1996
FORD	EXPLORER SPORT TRAC	V-6, 4.0 L	2001	-	2001
FORD	EXPLORER SPORT TRAC	V-6, 4.0 L	2007	-	2009
FORD	EXPLORER	V-8, 5.0 L	2001	-	1998
FORD	ESCAPE	V-6, 3.0 L	2005	-	2005
CHEVROLET	C y K SERIES PICKUP	V-8, 5.0 L	1999	-	1997
FORD	EXPLORER	V-6, 4.0 L	2003	-	1995
CADILLAC	ESCALADE	V-8, 5.7 L	2000	-	1999
CHEVROLET	C y K SERIES PICKUP	V-8, 5.7 L	2000	-	1996
CHEVROLET	C-2500	V-8, 5.7 L	2000	-	1996
CHEVROLET	C y K SERIES PICKUP	V-8, 8.1 L	2002	-	2001
FORD	FUSION	V-6, 3.0 L	2009	-	2009
CHEVROLET	SUBURBAN	V-8, 5.7 L	1999	-	1996
FORD	AEROSTAR	V-6, 4.0 L	1997	-	1996
CHEVROLET	C-3500	V-8, 5.7 L	2000	-	1996
FORD	ESCAPE	4 CIL, 2.0 L	2002	-	2001
CHEVROLET	C y K SERIES PICKUP	V-8, 7.4 L	2000	-	1999
FORD	EXPLORER	V-6, 4.0 L	2007	-	2009
CHEVROLET	C y K SERIES PICKUP	V-6, 4.3 L	1998	-	1996
FORD	FUSION	V-6, 3.0 L	2008	-	2007

### 38009

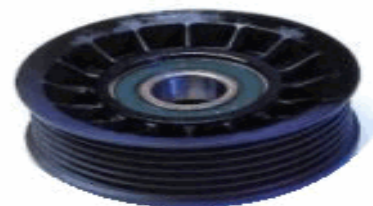

Termoplástico D.E. 76mm D.B. 17mm A - 25mm V-Ranura

CHEVROLET	UPLANDER	V-6, 3.5 L	2007	-	2006
HUMMER	H2	V-8, 6.0 L	2007	-	2006
CHEVROLET	SUBURBAN	V-8, 8.1 L	2006	-	2001
CHEVROLET	SUBURBAN	V-8, 6.0 L	2007	-	2000
FORD	WINDSTAR	V-6, 3.8 L	1998	-	1995
SAAB	9 - 5	V-6, 3.0 L	2003	-	2002
DODGE	RAM 2500	V-8, 4.7L	2003	-	2002
CHEVROLET	SUBURBAN	V-8, 6.0 L	2008	-	2010
DODGE	RAM 2500	V-8, 4.7 L	2004	-	2007
CHEVROLET	MALIBU	V-6, 3.5 L	2007	-	2004
GMC	SIERRA	V-8, 5.3 L	2009	-	2010
PONTIAC	GRAND PRIX	V-6, 3.8 L	2005	-	1997
CHEVROLET	MALIBU	V-6, 3.5 L	2005	-	2005
CADILLAC	CATERA	V-6, 3.0 L	2001	-	1998
CHEVROLET	TAHOE	V-8, 4.8 L	2007	-	2006
HUMMER	H2	V-8, 6.2 L	2008	-	2010
OLDSMOBILE	EIGHTY EIGHT	V-6, 3.8 L	1999	-	1999
CHEVROLET	CAVALIER	V-6, 3.1 L	1993	-	1993
CHEVROLET	CORVETTE	V-8, 6.0 L	2007	-	2006
CHEVROLET	VENTURE	V-6, 3.4 L	2004	-	1999
CHEVROLET	EXPRESS	V-8, 6.0 L	2008	-	2010
CHEVROLET	UPLANDER	V-6, 3.9 L	2008	-	2009
CHEVROLET	CORVETTE	V-8, 5.7 L	1993	-	1993
CHEVROLET	UPLANDER	V-6, 3.9 L	2007	-	2006
CHEVROLET	TAHOE	V-8, 5.3 L	2008	-	2010
CADILLAC	CTS	V-6, 3.2 L	2003	-	2003
CADILLAC	CTS	V-6, 3.2 L	2004	-	2004
CHEVROLET	TAHOE	V-8, 5.3 L	2007	-	2006
DODGE	INTREPID	V-6, 2.7 L	2003	-	2002
GMC	SIERRA	V-8, 6.2 L	2009	-	2010
CHEVROLET	EXPRESS	V-8, 6.0 L	2007	-	2003
DODGE	DURANGO	V-6, 3.7 L	2005	-	2004
DODGE	RAM 1500	V-6, 3.7 L	2006	-	2007
CHEVROLET	TRAILBLAZER	V-8, 5.3 L	2007	-	2003
DODGE	NITRO	V-6, 3.7 L	2008	-	2007
GMC	YUKON	V-8, 6.2 L	2009	-	2010
GMC	YUKON	V-8, 6.2 L	2008	-	2007
DODGE	NITRO	V-6, 4.0 L	2009	-	2010
CHEVROLET	MALIBU	V-6, 3.1 L	2003	-	1997
CHEVROLET	TRAILBLAZER	V-8, 6.0 L	2006	-	2006
JEEP	GRAND CHEROKEE	V-8, 4.7 L	2007	-	1999
FORD	E SERIES VAN	V-6, 4.2 L	2003	-	1997
CHEVROLET	TRAILBLAZER	V-8, 5.3 L	2005	-	2005

## Aplicación por Producto

DODGE	DURANGO	V-8, 4.7 L	2006	-	2000
JEEP	GRAND CHEROKEE	V-6, 3.7 L	2007	-	2005
CHEVROLET	SUBURBAN	V-8, 7.4 L	1995	-	1994
PONTIAC	G6	V-6, 3.9 L	2006	-	2006
PONTIAC	GRAND AM	V-6, 3.4 L	2005	-	2005
CHEVROLET	IMPALA	V-6, 3.8 L	2004	-	2004
GMC	SIERRA	V-8, 6.2 L	2008	-	2007
DODGE	NITRO	V-6, 4.0 L	2008	-	2007
CHEVROLET	UPLANDER	V-6, 3.5 L	2005	-	2005
SAAB	9 - 5	V-6, 3.0 L	2003	-	2000
JEEP	LIBERTY	V-6, 3.7 L	2005	-	2005
PONTIAC	GRAND AM	V-6, 3.4 L	2004	-	1999
CHEVROLET	CUTLASS	V-6, 3.1 L	1998	-	1997
CHEVROLET	VENTURE	V-6, 3.4 L	2005	-	2005
GMC	YUKON	V-8, 5.3 L	2008	-	2007
CHEVROLET	IMPALA	V-6, 3.8 L	2005	-	2005
JEEP	LIBERTY	V-6, 3.7 L	2007	-	2002
JEEP	LIBERTY	V-6, 3.7 L	2008	-	2009
DODGE	DAKOTA	V-6, 3.7 L	2008	-	2007
PONTIAC	G6	V-6, 3.5 L	2008	-	2006
CHEVROLET	SUBURBAN	V-8, 5.3 L	2007	-	2000
FORD	RANGER	4 CIL, 2.3 L	1997	-	1995
PONTIAC	AZTEK	V-6, 3.4 L	2005	-	2005
CADILLAC	ESCALADE	V-8, 6.0 L	2006	-	2002
CHEVROLET	SILVERADO	V-8, 4.8 L	2007	-	2001
CHEVROLET	EQUINOX	V-6, 3.4 L	2007	-	2005
CHRYSLER	VOYAGER	V-6, 3.0 L	2000	-	2000
FORD	F SERIES PICKUP	V-6, 4.2 L	2002	-	1998
MERCURY	COUGAR XR7	V-6, 3.8 L	1994	-	1993
PONTIAC	AZTEK	V-6, 3.4 L	2004	-	2001
CHEVROLET	SUBURBAN	V-8, 5.3 L	2008	-	2010
CHEVROLET	EXPRESS	V-8, 5.3 L	2007	-	2003
FORD	MUSTANG	V-6, 3.8 L	2001	-	1996
CHEVROLET	AVALANCHE	V-8, 5.3 L	2006	-	2005
CHEVROLET	CORVETTE	V-8, 6.0 L	2005	-	2005
FORD	THUNDERBIRD	V-6, 3.8 L	1994	-	1994
CHEVROLET	AVALANCHE	V-8, 5.3 L	2008	-	2010
CADILLAC	ESCALADE	V-8, 5.3 L	2004	-	2002
PONTIAC	MONTANA	V-6, 3.5 L	2006	-	2006
CHEVROLET	AVALANCHE	V-8, 5.3 L	2007	-	2002
CHEVROLET	SILVERADO	V-8, 5.3 L	2008	-	2010
CHEVROLET	SILVERADO	V-8, 5.3 L	2007	-	2000
PONTIAC	MONTANA	V-6, 3.9 L	2008	-	2006
CHEVROLET	SILVERADO	V-8, 6.0 L	2007	-	2000
PONTIAC	BONNEVILLE	V-6, 3.8 L	2003	-	1995
CHEVROLET	AVALANCHE	V-8, 8.1 L	2002	-	2002
CADILLAC	ESCALADE	V-8 6.2 L	2008	-	2010
CHEVROLET	EXPRESS	V-8, 5.3 L	2008	-	2010
CHEVROLET	SILVERADO	V-8, 4.8 L	2008	-	2010
CHEVROLET	SILVERADO	V-8, 8.1 L	2007	-	2001
FORD	F-150	V-6, 4.2 L	2006	-	2003
DODGE	RAM SERIES PICKUP	V-6, 3.7 L	2003	-	2002

MERCURY	SABLE / TAURUS	V-6, 3.8 L	1995	-	1993
DODGE	RAM SERIES PICKUP	V-8, 4.7L	2003	-	2002
CADILLAC	ESCALADE	V-8, 6.2 L	2007	-	2007
PONTIAC	TORRENT	V-6, 3.4 L	2008	-	2006

### 38010



Acero D.E. 90mm D.B. 17mm A - 27mm Lisa

CHEVROLET	TRACKER	4 CIL, 2.0 L	2003	-	1999
SUZUKI	AERIO	4 CIL, 2.3 L	2006	-	2005

### 38011



CHEVROLET	CAPTIVA	4 CIL, 2.4 L	2009	-	2010
PONTIAC	GRAND AM	4 CIL, 2.2 L	2003	-	2002
PONTIAC	SOLSTICE	4 CIL, 2.4 L	2008	-	2006
PONTIAC	G5	4 CIL, 2.2 L	2008	-	2007
PONTIAC	SUNFIRE	4 CIL, 2.2 L	2005	-	2005
PONTIAC	G5	4 CIL, 2.4 L	2008	-	2007
PONTIAC	SUNFIRE	4 CIL, 2.2 L	2004	-	1998
PONTIAC	SUNFIRE	4 CIL, 2.4 L	1998	-	1996
CHEVROLET	CAVALIER	4 CIL, 2.4 L	1998	-	1996
PONTIAC	SUNFIRE	4 CIL, 2.3 L	1995	-	1995
CHEVROLET	CAVALIER	4 CIL, 2.3 L	1995	-	1995
CHEVROLET	CAVALIER	4 CIL, 2.2 L	2004	-	1998
PONTIAC	G4	4 CIL, 2.2 L	2006	-	2006
CHEVROLET	HHR	4 CIL, 2.4 L	2007	-	2006
CHEVROLET	MALIBU	4 CIL, 2.4 L	1998	-	1997
PONTIAC	GRAND AM	4 CIL, 2.4 L	1999	-	1999
CHEVROLET	MALIBU	4 CIL, 2.2 L	2007	-	2004
CHEVROLET	CAPTIVA	4 CIL, 2.4 L	2008	-	2008
PONTIAC	G4	4 CIL, 2.4 L	2006	-	2006
SAAB	9 - 3	4 CIL, 2.0 L	2006	-	2003
CHEVROLET	CAVALIER	4 CIL, 2.2 L	2005	-	2005

## Aplicación por Producto

### 38015



Termoplástico D.E. 76mm D.B. 17mm A - 25mm Lisa

AUDI	A6	V-6, 3.0 L	2006	-	2005
FORD	F-350 SUPER DUTY	V-8, 5.0 L	1996	-	1993
SUZUKI	SWIFT	4 CIL, 1.6 L	2007	-	2006
AUDI	A6	V-6, 3.2 L	2007	-	2006
PONTIAC	SUNFIRE	4 CIL, 2.2 L	2002	-	1998
PONTIAC	GRAND PRIX	V-6, 3.8 L	1998	-	1997
CHEVROLET	CAVALIER	4 CIL, 2.2 L	2002	-	1998
AUDI	A6	V-6, 3.2 L	2008	-	2008
SUZUKI	SWIFT	4 CIL, 1.6 L	2008	-	2008
CHEVROLET	AVEO	4 CIL, 1.6 L	2009	-	2009
CHEVROLET	LUMINA	V-6, 3.8 L	1998	-	1998
FORD	F SERIES PICKUP	V-8, 5.0 L	1996	-	1995
CHEVROLET	CORVETTE	V-8, 5.7 L	1996	-	1993
FORD	F SERIES PICKUP	V-8, 5.8 L	1996	-	1995
CHEVROLET	AVEO	4 CIL, 1.6 L	2008	-	2008
AUDI	A4	V-6, 3.2 L	2008	-	2009
PONTIAC	BONNEVILLE	V-6, 3.8 L	1998	-	1994
FORD	F-250	V-8, 5.0 L	1996	-	1993
PONTIAC	G3	4 CIL, 1.6 L	2008	-	2006
AUDI	A4	V-6, 3.2 L	2007	-	2006
DODGE	RAM 2500	V-8, 4.7 L	2004	-	2007
OLDSMOBILE	EIGHTY EIGHT	V-6, 3.8 L	1998	-	1998
CHEVROLET	REGAL	V-6, 3.8 L	1996	-	1996
FORD	AEROSTAR	V-6, 3.0 L	1997	-	1993
JEEP	LIBERTY	V-6, 3.7 L	2008	-	2009
CHEVROLET	S-10	4 CIL, 2.2 L	2003	-	1998
DODGE	RAM 1500	V-6, 3.7 L	2006	-	2007

### 38016

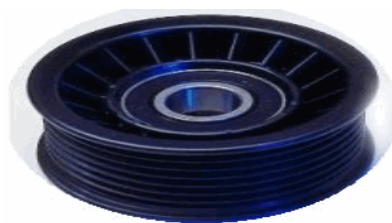

Termoplástico D.E. 76mm D.B. 17mm A - 32mm V-Ranura

DODGE	RAM SERIES PICKUP	V-8, 5.2 L	2001	-	1995
DODGE	RAM MAXI WAGON 3500	V-8, 5.2 L	1996	-	1996
DODGE	RAM WAGON 1500	V-8, 5.2 L	2001	-	1997
DODGE	D-250	V-8, 5.9 L	1993	-	1993
DODGE	D-150	V-6, 3.9 L	1993	-	1993
DODGE	RAM 2500	V-8, 5.9 L	2002	-	1994

DODGE	RAM 4000	V-8, 5.9 L	2002	-	1995
DODGE	RAM 3500	V-8, 5.9 L	2002	-	1994
DODGE	RAM SERIES PICKUP	V-6, 3.9 L	2001	-	1994
DODGE	RAM MAXI VAN 3500	V-8, 5.9 L	2002	-	1996
DODGE	RAM MAXI VAN 2500	V-8, 5.2 L	2002	-	1996
DODGE	RAM WAGON 2500	V-8, 5.2 L	2001	-	1997
DODGE	RAM CHARGER	V-8, 5.9 L	1993	-	1993
DODGE	RAM MAXI VAN 1500	V-6, 3.9 L	2002	-	1999
DODGE	RAM MAXI WAGON 3500	V-8, 5.9 L	2002	-	1996
DODGE	RAM SERIES PICKUP	V-8, 5.9 L	2002	-	1994
DODGE	RAM 1500	V-6, 3.9 L	2001	-	1994
DODGE	RAM WAGON 2500	V-8, 5.9 L	1995	-	1994
DODGE	DURANGO	V-6, 3.9 L	1999	-	1998
DODGE	RAM WAGON 3500	V-8, 5.9 L	2002	-	2002
JEEP	GRAND CHEROKEE	V-8, 5.9 L	1998	-	1998
DODGE	DURANGO	V-8, 5.2 L	2000	-	1998
DODGE	DURANGO	V-8, 5.9 L	2003	-	1998
DODGE	RAM 2500	V-8, 5.2 L	2001	-	1997
DODGE	D-350	V-8, 5.9 L	1993	-	1993
JEEP	GRAND CHEROKEE	V-8, 5.2 L	1998	-	1995

### 38018

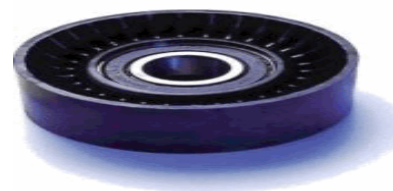

Termoplástico D.E. 70mm D.B. 17mm A - 25mm Lisa

TOYOTA	MATRIX	4 CIL, 1.8 L	2008	-	2003
FORD	ESCAPE	4 CIL, 2.0 L	2002	-	2001
VOLKSWAGEN	PASSAT	4 CIL, 2.0 L	2008	-	2006
BMW	330XI	6 CIL, 3.0 L	2006	-	2005
CHEVROLET	COLORADO	5 CIL, 3.5 L	2004	-	2004
BMW	530I	6 CIL, 3.0 L	2002	-	2002
DODGE	NITRO	V-6, 4.0 L	2008	-	2007
DODGE	NITRO	V-6, 4.0 L	2009	-	2010
DODGE	JOURNEY	V-6, 3.5 L	2009	-	2010
FORD	CONTOUR	4 CIL, 2.0 L	2000	-	1998
VOLVO	C70	5 CIL, 2.4 L	2004	-	2000
AUDI	A3	4 CIL, 2.0 L	2008	-	2008
CHEVROLET	COLORADO	4 CIL, 2.8 L	2005	-	2005
VOLKSWAGEN	ROUTAN	V-6, 3.8 L	2009	-	2010
VOLVO	C70	5 CIL, 2.3 L	2004	-	2000
BMW	545I	V-8, 4.4 L	2005	-	2005
AUDI	A3	4 CIL, 2.0 L	2007	-	2006
TOYOTA	CAMRY	4 CIL, 2.5 L	2010	-	2011
DODGE	DURANGO	V-8, 5.7 L	2008	-	2009
DODGE	CARAVAN	V-6, 3.3 L	2007	-	2002
FORD	FOCUS	4 CIL, 2.0 L	2002	-	2000
VOLKSWAGEN	JETTA	4 CIL, 2.0 L	2008	-	1999

## Aplicación por Producto

DODGE	RAM 2500	V-8, 5.7 L	2009	-	2009
TOYOTA	COROLLA	4 CIL, 1.8 L	2008	-	2002
CHEVROLET	COLORADO	5 CIL, 3.5 L	2006	-	2005
CHEVROLET	COLORADO	4 CIL, 2.8 L	2006	-	2006
CHRYSLER	300 C	V-8, 5.7 L	2007	-	2009
VOLKSWAGEN	BEETLE	4 CIL, 1.8 L	2005	-	1999
JEEP	GRAND CHEROKEE	V-8, 5.7 L	2008	-	2009
BMW	X5	V-8, 4.6 L	2002	-	2002
JEEP	GRAND CHEROKEE	V-8, 5.7 L	2007	-	2005
JEEP	COMMANDER	V-8, 5.7 L	2008	-	2006
CHRYSLER	TOWN & COUNTRY	V-6, 3.8 L	2007	-	2005
BMW	X5	V-6, 3.0 L	2009	-	2009
VOLKSWAGEN	GOLF	4 CIL, 2.0 L	2006	-	1999
JEEP	GRAND CHEROKEE	6 CIL, 4.0 L	2002	-	1999
JEEP	WRANGLER	V-6, 3.8 L	2008	-	2010
BMW	X3	V-6, 3.0 L	2007	-	2008
JEEP	WRANGLER	6 CIL, 4.0 L	2006	-	2000
BMW	X5	V-8, 4.4 L	2000	-	2000
MERCURY	MYSTIQUE	4 CIL, 2.0 L	2000	-	1998
VOLVO	S60	5 CIL, 2.5 L	2006	-	2004
JEEP	GRAND CHEROKEE	V-6, 4.0 L	2003	-	2003
BMW	X3	6 CIL, 3.0 L	2006	-	2006
VOLKSWAGEN	GOLF	4 CIL, 1.8 L	2006	-	2000
JEEP	WRANGLER	4 CIL, 2.4 L	2006	-	2003
AUDI	TT	4 CIL, 1.8 L	2001	-	2000
CHRYSLER	TOWN & COUNTRY	V6, 4.0 L	2008	-	2010
JEEP	GRAND CHEROKEE	V-8, 6.1 L	2007	-	2006
VOLKSWAGEN	BEETLE	4 CIL, 2.0 L	2008	-	1998
CHRYSLER	VOYAGER	V-6, 3.3 L	2007	-	2001
VOLVO	S60	5 CIL, 2.4 L	2006	-	2001
DODGE	CHARGER	V-8, 6.1 L	2008	-	2007
BMW	X5	6 CIL, 3.0 L	2006	-	2006
CHEVROLET	TRAILBLAZER	6 CIL, 4.2 L	2005	-	2005
VOLVO	S80	6 CIL, 2.9 L	2005	-	2000
VOLKSWAGEN	JETTA	4 CIL, 1.9 L DIESE2007	2007	-	2004
VOLKSWAGEN	JETTA	4 CIL, 2.0 L	2009	-	2010
VOLVO	S80	6 CIL, 2.8 L	2001	-	2000
BMW	325XI	6 CIL, 2.5 L	2005	-	2005
AUDI	TT	4 CIL, 1.8 L	2006	-	2002
JEEP	COMMANDER	V-8, 5.7 L	2009	-	2009
BMW	X3	6 CIL, 3.0 L	2005	-	2005
VOLVO	S70	5 CIL, 2.3 L	2000	-	2000
DODGE	CHARGER	V-8, 5.7 L	2008	-	2007
VOLVO	S60	5 CIL, 2.3 L	2001	-	2001
VOLVO	S80	5 CIL, 2.5 L	2006	-	2005
DODGE	CHARGER	V-8, 5.7 L	2009	-	2009
VOLVO	S70	5 CIL, 2.4 L	2000	-	2000
VOLKSWAGEN	BORA	4 CIL, 1.9 L DIESE2007	2007	-	2007
CHEVROLET	TRAILBLAZER	6 CIL, 4.2 L	2007	-	2002
VOLVO	S40	4 CIL, 1.9 L	2004	-	2000
BMW	X5	6 CIL, 3.0 L	2005	-	2005
VOLKSWAGEN	JETTA	4 CIL, 1.8 L	2006	-	2000

### 38019



Termoplástico D.E. 90mm D.B. 17mm A - 26.3mm V-Ran

JEEP	CHEROKEE	6 CIL, 4.0 L	2001	-	1996
CHEVROLET	SUBURBAN	V-8, 7.4 L	1995	-	1993
JEEP	WRANGLER	6 CIL, 4.0 L	1998	-	1997
JEEP	WRANGLER	4 CIL, 2.5 L	1998	-	1997

### 38020

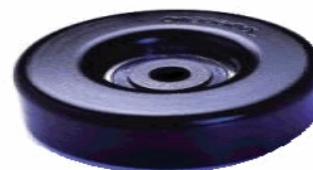

Acero D.E. 90mm D.B. 12mm A - 30.5mm Lisa

DODGE	STRATUS	4 CIL, 2.0 L	2000	-	1996
DODGE	INTREPID	V-6, 3.5 L	2000	-	1994
CADILLAC	DEVILLE	V-8, 4.9 L	1993	-	1993
DODGE	INTREPID	V-6, 3.2 L	2000	-	1998
CHRYSLER	VOYAGER	V-6, 3.3 L	2000	-	1996
CHEVROLET	EXPRESS	V-8, 6.5 L	2002	-	1999
CHEVROLET	C y K SERIES PICKUP	V-8, 6.5 L	2002	-	1999
CHRYSLER	CIRRUS	4 CIL, 2.4 L	2000	-	1997
JEEP	WRANGLER	4 CIL, 2.5 L	2002	-	1995
CHRYSLER	SEBRING	4 CIL, 2.4 L	1997	-	1997
CHRYSLER	GRAND VOYAGER	V-6, 3.8 L	1999	-	1994
CHRYSLER	NEW YORKER	V-6, 3.3 L	1993	-	1993
CHRYSLER	CONCORDE	V-6, 3.5 L	1997	-	1993
JEEP	CHEROKEE	6 CIL, 4.0 L	2000	-	1995
CHRYSLER	CONCORDE	V-6, 3.2 L	2001	-	1999
CHRYSLER	SEBRING	4 CIL, 2.4 L	1996	-	1996
CHRYSLER	CIRRUS	4 CIL, 2.0 L	2000	-	2000
DODGE	STRATUS	4 CIL, 2.4 L	2000	-	1995
JEEP	GRAND CHEROKEE	6 CIL, 4.0 L	1999	-	1996
CHRYSLER	300M	V-6, 3.5 L	2000	-	1999
DODGE	STRATUS	V-6, 2.5 L	2000	-	1999
CHRYSLER	CIRRUS	V-6, 2.5 L	2000	-	1996



### 38022

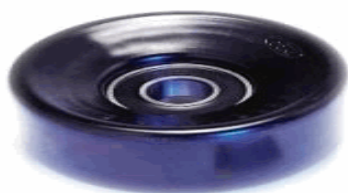

Acero D.E. 90mm D.B. 17mm A - 37.5mm Lisa

FORD	EXPLORER	V-8, 4.6 L	2003	-	2002
FORD	E SERIES VAN	V-10, 6.8 L	1998	-	1997
FORD	E SERIES VAN	V-8, 4.6 L	2001	-	1999
FORD	F SERIES PICKUP	V-10, 6.8 L	2000	-	1999
FORD	SUPER DUTY PICKUP	V-8, 5.4 L	2002	-	1999
FORD	SUPER DUTY VAN	V-8, 4.6 L	2003	-	2003
FORD	SUPER DUTY VAN	V-10, 6.8 L	2001	-	1999
FORD	MUSTANG	V-6, 3.8 L	1998	-	1996
FORD	F SERIES PICKUP	V-6, 4.9 L	1996	-	1995
FORD	E SERIES VAN	6 CIL, 4.9 L	1996	-	1995
FORD	E SERIES VAN	V-8, 7.3 L	1997	-	1997
LINCOLN	NAVIGATOR	V-8, 5.4 L	2002	-	1998
FORD	F SERIES PICKUP	V-8, 4.6 L	2001	-	1998
FORD	F SERIES PICKUP	V-8, 5.4 L	2002	-	1999
FORD	EXCURSION	V-8, 5.4 L	2001	-	2001
FORD	F-150	V-6, 4.9 L	1996	-	1995
FORD	F-450 SUPER DUTY	V-10, 6.8 L	2006	-	1999
FORD	E SERIES VAN	V-8, 5.4 L	2002	-	1997
FORD	F-250	V-8, 4.6 L	2004	-	1998
FORD	F-350 SUPER DUTY	V-8, 5.4 L	2006	-	1999
FORD	EXPEDITION	V-8, 4.6 L	2002	-	1997
FORD	EXCURSION	V-10, 6.8 L	2005	-	2000
FORD	SUPER DUTY VAN	V-8, 5.4 L	2001	-	1999
FORD	LOBO	V-8, 5.4 L	2002	-	2002
FORD	SUPER DUTY PICKUP	V-10, 6.8 L	2002	-	1999
FORD	EXPEDITION	V-8, 5.4 L	2002	-	1997

### 38023

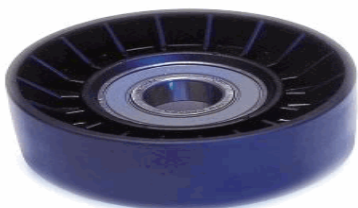

Termoplástico D.E. 76mm D.B. 17mm A - 34mm Lisa

FORD	F-350 SUPER DUTY	V-8, 5.4 L	2006	-	1999
LINCOLN	NAVIGATOR	V-8, 5.4 L	2002	-	1998
FORD	F SERIES PICKUP	V-10, 6.8 L	2000	-	1999
FORD	F-450 SUPER DUTY	V-10, 6.8 L	2006	-	1999
FORD	EXCURSION	V-8, 5.4 L	2001	-	2000
FORD	EXCURSION	V-10, 6.8 L	2003	-	2000
MERCURY	SABLE / TAURUS	V-6, 3.8 L	1995	-	1995

FORD	SUPER DUTY VAN	V-10, 6.8 L	2001	-	1999
FORD	SUPER DUTY PICKUP	V-8, 7.3 L	2002	-	1999
FORD	EXPEDITION	V-8, 5.4 L	2002	-	1997
FORD	SUPER DUTY PICKUP	V-8, 5.4 L	2002	-	1999
FORD	LOBO	V-8, 5.4 L	2002	-	2002
FORD	THUNDERBIRD	V-6, 3.8 L	1994	-	1994
FORD	F-250	V-8, 4.6 L	2004	-	1998
FORD	F SERIES PICKUP	V-8, 5.4 L	2002	-	1999
FORD	SUPER DUTY PICKUP	V-10, 6.8 L	2002	-	1999
FORD	EXPEDITION	V-8, 4.6 L	2002	-	1997
FORD	F SERIES PICKUP	V-8, 4.6 L	2001	-	1998
FORD	WINDSTAR	V-6, 3.8 L	1995	-	1995
FORD	E SERIES VAN	V-8, 5.4 L	2002	-	1997
FORD	SUPER DUTY VAN	V-8, 7.3 L	2001	-	1999
FORD	E SERIES VAN	V-10, 6.8 L	1998	-	1997
FORD	E SERIES VAN	V-8, 4.6 L	2001	-	1999
FORD	SUPER DUTY VAN	V-8, 5.4 L	2001	-	1999

### 38024

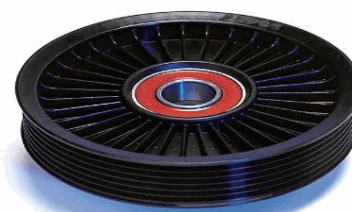

SUZUKI	SWIFT	4 CIL, 1.6 L	2008	-	2008
CHEVROLET	C y K SERIES PICKUP	V-6, 4.3 L	1995	-	1995
CHEVROLET	C-2500	V-8, 5.7 L	1995	-	1993
CHEVROLET	SUBURBAN	V-8, 5.7 L	1995	-	1993
CHEVROLET	S-10	V-6, 4.3 L	1995	-	1994
CHEVROLET	AVEO	4 CIL, 1.6 L	2008	-	2008
PONTIAC	G3	4 CIL, 1.6 L	2008	-	2006
CHEVROLET	AVEO	4 CIL, 1.6 L	2009	-	2009
CHEVROLET	C-35	V-8, 5.7 L	1993	-	1993
SUZUKI	SWIFT	4 CIL, 1.6 L	2007	-	2006
CHEVROLET	C-3500	V-8, 5.7 L	1995	-	1994
CHEVROLET	BLAZER	V-6, 4.3 L	1995	-	1993
CHEVROLET	C y K SERIES PICKUP	V-8, 5.7 L	1995	-	1993

### 38025



Termoplástico D.E. 52mm D.B. 17mm A - 15mm V-Ranura

CADILLAC	DEVILLE	V-8, 4.6 L	2005	-	1998
CADILLAC	DTS	V-8, 4.6 L	2007	-	2006
TOYOTA	CAMRY	4 CIL, 2.5 L	2010	-	2011



## Aplicación por Producto

CADILLAC	SEVILLE	V-8, 4.6 L	2004 - 1995
CADILLAC	EL DORADO	V-8, 4.6 L	1997 - 1995
CADILLAC	EL DORADO	V-8, 4.6 L	2002 - 1998

FORD	MUSTANG	V-6, 3.8 L	2000 - 1996
------	---------	------------	-------------

### 38030



Acero D.E. 70mm D.B. 17mm A - 20.5mm V-Ranurada

SUBARU	LEGACY	4 CIL, 2.5 L	2007 - 2006
HONDA	CR-V	4 CIL, 2.0 L	2001 - 1999
HONDA	CIVIC	4 CIL, 1.6 L	1999 - 1997
SUBARU	FORESTER	4 CIL, 2.5 L	2006 - 2006
SUBARU	IMPREZA	4 CIL, 2.5 L	2007 - 2006
SUBARU	FORESTER	4 CIL, 2.5 L	2007 - 2007
SUBARU	OUTBACK	4 CIL, 2.5 L	2006 - 2006

### 38026

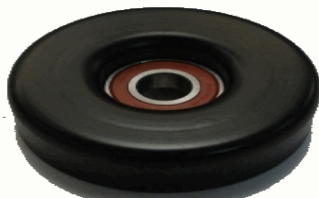

Acero D.E. 100mm D.B. 17mm A - 28mm Lisa

CHEVROLET	CAVALIER	4 CIL, 2.2 L	1997 - 1993
PONTIAC	SUNFIRE	4 CIL, 2.2 L	1997 - 1995

### 38027



Termoplástico D.E. 82mm D.B. 17mm A - 25mm Lisa

CHEVROLET	LUMINA	V-6, 3.4 L	1995 - 1993
OLDSMOBILE	SILHOUETTE	V-6, 3.8 L	1995 - 1994
CHEVROLET	LUMINA	V-6, 3.4 L	1997 - 1996
CHEVROLET	REGAL	V-6, 3.8 L	1995 - 1994

### 38031

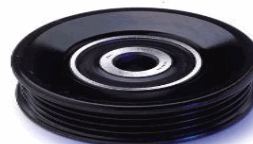

Acero D.E. 70mm D.B. 12mm A - 20.5mm V-Ranurada

TOYOTA	4 RUNNER	V-6, 3.4 L	2002 - 2002
--------	----------	------------	-------------

### 38028



Acero D.E. 76mm D.B. 17mm A - 37mm Lisa

FORD	E SERIES VAN	V-8, 7.3 L	1998 - 1998
FORD	SUPER DUTY PICKUP	V-8, 7.3 L	2002 - 1999
FORD	F-450 SUPER DUTY	V-8, 7.3 L	2003 - 2002
FORD	SUPER DUTY VAN	V-8, 7.3 L	2001 - 1999

### 38032

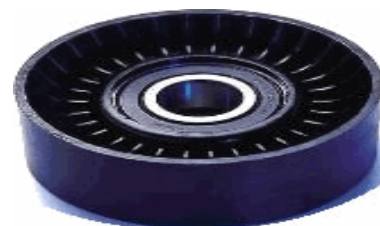

Termoplástico D.E. 76mm D.B. 17mm A - 22mm Lisa

CHEVROLET	CAVALIER	4 CIL, 2.4 L	1999 - 1999
PONTIAC	SUNFIRE	4 CIL, 2.4 L	2002 - 1999
FORD	TOPAZ	4 CIL, 2.3 L	1994 - 1994
CHEVROLET	CAVALIER Z24	4 CIL, 2.4 L	2002 - 1998

### 38029



Termoplástico D.E. 7mm D.B. 17mm A - 26mm V-Ranurac

### 38033



Acero D.E. 90mm D.B. 17mm A - 33mm Lisa

## Aplicación por Producto

DODGE	RAM SERIES PICKUP	V-6, 3.9 L	2001	-	1995
DODGE	RAM SERIES PICKUP	V-8, 5.2 L	2001	-	1995
JEEP	GRAND CHEROKEE	V-8, 5.9 L	1998	-	1998
DODGE	VIPER	V-10, 8.0 L	2002	-	1998
DODGE	DURANGO	V-8, 5.9 L	2003	-	1998
DODGE	RAM SERIES PICKUP	V-8, 5.9 L	2002	-	1995
DODGE	DURANGO	V-6, 3.9 L	1999	-	1998
JEEP	GRAND CHEROKEE	V-8, 5.2 L	1998	-	1995
DODGE	DURANGO	V-8, 5.2 L	2000	-	1998
DODGE	RAM SERIES PICKUP	V-10, 8.0 L	2003	-	1999

### 38034



Termoplástico D.E. 27mm D.B. 12mm A - 29mm V-Ranura

CHRYSLER	GRAND VOYAGER	V-6, 3.3 L	2000	-	2000
CHRYSLER	VOYAGER	V-6, 3.3 L	2000	-	2000
DODGE	CARAVAN	V-6, 3.3 L	2000	-	1995

### 38036

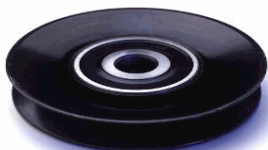

Acero D.E. 81mm D.B. 12mm A - 17.5mm V-Ranura

NISSAN	PICK-UP	4 CIL, 2.4 L	1997	-	1993
--------	---------	--------------	------	---	------

### 38037



Acero D.E. 81mm D.B. 17mm A - 18mm V-Ranura

NISSAN	XTERRA	4 CIL, 2.4 L	2004	-	2000
NISSAN	FRONTIER	4 CIL, 2.4 L	2004	-	1999

### 38040



Acero D.E. 123mm D.B. 12mm A - 18.5mm V-Ranura

CHRYSLER	NEW YORKER	V-6, 3.5 L	1996	-	1994
CHRYSLER	300M	V-6, 3.5 L	2004	-	1999
DODGE	INTREPID	V-6, 3.2 L	2001	-	1998
CHRYSLER	CONCORDE	V-6, 3.2 L	2001	-	1998
DODGE	INTREPID	V-6, 3.5 L	2002	-	1995
CHRYSLER	CONCORDE	V-6, 3.5 L	2002	-	1993

### 38041



Acero D.E. 76mm D.B. 17mm A - 30.5mm Lisa

CADILLAC	DTS	V-8, 4.6 L	2007	-	2006
CADILLAC	EL DORADO	V-8, 4.6 L	2002	-	1998
CHEVROLET	CAMARO Z28	V-8, 5.7 L	2002	-	2000
CADILLAC	SEVILLE	V-8, 4.6 L	2004	-	1998
CADILLAC	DEVILLE	V-8, 4.6 L	2005	-	1998

### 38042



Acero D.E. 90mm D.B. 10mm A - 30mm Lisa

DODGE	RAM SERIES PICKUP	V-6, 3.7 L	2003	-	2002
CHRYSLER	NEW YORKER	V-6, 3.8 L	1993	-	1993
JEEP	WRANGLER	6 CIL, 4.0 L	1999	-	1997
DODGE	DURANGO	V-8, 4.7 L	2004	-	2002
CHRYSLER	NEW YORKER	V-6, 3.5 L	1996	-	1994
CHRYSLER	NEW YORKER	V-6, 3.3 L	1993	-	1993
CHRYSLER	CIRRUS	4 CIL, 2.0 L	2000	-	2000
CHRYSLER	VOYAGER	V-6, 3.3 L	2000	-	2000
DODGE	RAM SERIES PICKUP	V-8, 4.7L	2003	-	2002
DODGE	CARAVAN	4 CIL, 2.4 L	1997	-	1997
JEEP	GRAND CHEROKEE	6 CIL, 4.0 L	1998	-	1994
CHRYSLER	SEBRING	V-6, 2.5 L	2000	-	1996
DODGE	RAM 1500	V-6, 3.7 L	2005	-	2002

## Aplicación por Producto

JEEP	WRANGLER	4 CIL, 2.5 L	2002 - 1993
JEEP	CHEROKEE	4 CIL, 2.5 L	1998 - 1995
CHRYSLER	CIRRUS	4 CIL, 2.4 L	2000 - 1995
DODGE	ADVENTURER	V-6, 3.3 L	2000 - 1993
CHRYSLER	CIRRUS	V-6, 2.5 L	1999 - 1998
DODGE	CARAVAN	V-6, 3.0 L	1995 - 1995
DODGE	STRATUS	V-6, 2.5 L	2000 - 1995
DODGE	INTREPID	V-6, 3.5 L	2002 - 1995
DODGE	INTREPID	V-6, 3.2 L	2001 - 1998
CHRYSLER	CONCORDE	V-6, 3.5 L	2002 - 1993
DODGE	CARAVAN	V-6, 3.3 L	2000 - 1995
DODGE	RAM 2500	V-8, 4.7L	2003 - 2002
CHRYSLER	CONCORDE	V-6, 3.2 L	2001 - 1998
JEEP	CHEROKEE	6 CIL, 4.0 L	2001 - 1995
CHRYSLER	CIRRUS	4 CIL, 2.4 L	1999 - 1999
CHRYSLER	LEBARON	V-6, 3.0 L	1995 - 1993
CHRYSLER	CIRRUS	V-6, 2.5 L	2000 - 1995
CHRYSLER	300M	V-6, 3.5 L	2004 - 1999
JEEP	LIBERTY	V-6, 3.7 L	2007 - 2002
CHRYSLER	VOYAGER	V-6, 3.0 L	2000 - 2000
DODGE	STRATUS	4 CIL, 2.4 L	2000 - 1995
JEEP	GRAND CHEROKEE	V-8, 4.7 L	2003 - 2002
DODGE	SPIRIT	V-6, 3.0 L	1994 - 1994
CHRYSLER	SEBRING	4 CIL, 2.4 L	1999 - 1996
DODGE	STRATUS	4 CIL, 2.0 L	2000 - 1995
JEEP	LIBERTY	V-6, 3.7 L	2005 - 2005
CHRYSLER	GRAND VOYAGER	V-6, 3.3 L	2000 - 2000

### 38043



Acero D.E. 76mm D.B. 10mm A - 30mm Lisa

CHEVROLET	EQUINOX	V-6, 3.4 L	2007 - 2005
CHEVROLET	VENTURE	V-6, 3.4 L	2005 - 2002
DODGE	CARAVAN	V-6, 3.3 L	2007 - 2002
JEEP	GRAND CHEROKEE	6 CIL, 4.0 L	2002 - 1998
PONTIAC	MONTANA	V-6, 3.5 L	2006 - 2006
DODGE	CARAVAN	V-6, 3.3 L FLEX	2003 - 2001
CHRYSLER	VOYAGER	V-6, 3.3 L	2007 - 2001
JEEP	GRAND CHEROKEE	V-6, 4.0 L	2003 - 2003
CHEVROLET	MALIBU	V-6, 3.5 L	2006 - 2004
CHEVROLET	MALIBU	V-6, 3.1 L	2003 - 2002
PONTIAC	TORRENT	V-6, 3.4 L	2008 - 2006
JEEP	CHEROKEE	4 CIL, 2.5 L	1998 - 1997
JEEP	CHEROKEE	6 CIL, 4.0 L	1999 - 1997
CHRYSLER	CONCORDE	V-6, 2.7 L	2000 - 1998
CHRYSLER	TOWN & COUNTRY	V-6, 3.8 L	2007 - 2001

DODGE	INTREPID	V-6, 2.7 L	2003 - 1998
JEEP	WRANGLER	6 CIL, 4.0 L	2006 - 1997
PONTIAC	G6	V-6, 3.5 L	2006 - 2006
JEEP	WRANGLER	4 CIL, 2.5 L	2002 - 1997
PONTIAC	AZTEK	V-6, 3.4 L	2005 - 2003
CHEVROLET	UPLANDER	V-6, 3.5 L	2006 - 2005

### 38044



Acero D.E. 80mm D.B. 17mm A - 21.8mm V-Ranurada

NISSAN	QUEST	V-6, 3.0 L	1998 - 1997
NISSAN	ALTIMA	4 CIL, 2.4 L	2001 - 1998
NISSAN	QUEST	V-6, 3.3 L	2000 - 1999

### 38049



Acero D.E. 80mm D.B. A - 31mm Lisa

FORD	AEROSTAR	V-6, 3.0 L	1994 - 1994
------	----------	------------	-------------

### 38052

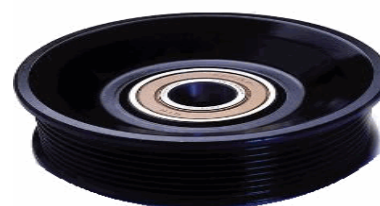

Acero D.E. 90mm D.B. 17mm A - 37mm V-Ranurada

FORD	E SERIES VAN	V-8, 7.3 L	1997 - 1997
------	--------------	------------	-------------

### 38053



Acero D.E. 76mm D.B. 17mm A - 38mm V-Ranurada

FORD	SUPER DUTY PICKUP	V-8, 5.4 L	2001 - 1999
FORD	E SERIES VAN	V-8, 4.6 L	2001 - 1999

## Aplicación por Producto

FORD	F SERIES PICKUP	V-8, 5.4 L	2001 - 1999
FORD	SUPER DUTY VAN	V-10, 6.8 L	2001 - 2000
FORD	E SERIES VAN	V-8, 7.3 L	1998 - 1998
FORD	SUPER DUTY VAN	V-8, 7.3 L	2001 - 1999
FORD	F-250	V-8, 4.6 L	2004 - 1998
FORD	F SERIES PICKUP	V-8, 4.6 L	2001 - 1998
FORD	SUPER DUTY PICKUP	V-8, 7.3 L	2002 - 1999
FORD	F-450 SUPER DUTY	V-8, 7.3 L	2003 - 2002
FORD	SUPER DUTY VAN	V-8, 5.4 L	2001 - 1999
FORD	E SERIES VAN	V-10, 6.8 L	1998 - 1998
FORD	E SERIES VAN	V-8, 5.4 L	2001 - 1997

### 38063



Termoplástico D.E. 70mm D.B. 17mm A - 28mm Lisa

BMW	760LI	V-12, 6.0 L	2005 - 2005
BMW	740IL	V-8, 4.4 L	2001 - 1998
BMW	X5	V-8, 4.6 L	2002 - 2002
BMW	745I	V-8, 4.4 L	2005 - 2005
BMW	745LI	V-8, 4.4 L	2005 - 2005
BMW	760I	V-12, 6.0 L	2005 - 2005
BMW	740I	V-8, 4.4 L	2001 - 1998
BMW	540I	V-8, 4.4 L	2001 - 1998
BMW	X5	V-8, 4.4 L	2000 - 2000

### 38058

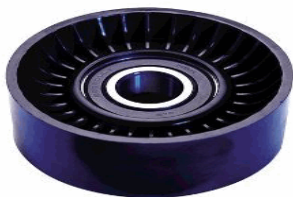

Termoplástico D.E. 76mm D.B. 17mm A - 29.5mm Lisa

DODGE	DURANGO	V-8, 5.7 L	2007 - 2004
DODGE	RAM 3500	V-8, 5.7 L	2007 - 2003
CHRYSLER	ASPEN	V-8, 5.7 L	2007 - 2009
DODGE	RAM 2500	V-8, 5.7 L	2008 - 2008
DODGE	RAM SERIES PICKUP	V-8, 5.9 L	2001 - 1997
DODGE	RAM SERIES PICKUP	V-10, 8.0 L	2000 - 1999

### 38066



Termoplástico D.E. 70mm D.B. 24mm\* A - 28mm Lisa

BMW	740I	V-8, 4.4 L	2001 - 1998
BMW	740IL	V-8, 4.4 L	2001 - 1998
BMW	540I	V-8, 4.4 L	2001 - 1998

### 38061



Termoplástico D.E. 75mm D.B. 24.5mm\* A - 24.5mm Lisa

BMW	750IL	V-12, 5.4 L	2000 - 1998
-----	-------	-------------	-------------

### 38068



Acero D.E. 60mm D.B. 25.7mm\* A - 22.5mm V-Ranurada

VOLKSWAGEN	PASSAT	4 CIL, 1.8 L	2005 - 2005
VOLKSWAGEN	PASSAT	4 CIL, 1.8 L	2004 - 1999
AUDI	A4	4 CIL, 1.8 L	2001 - 1998

### 38062



Termoplástico D.E. 70mm D.B. 24mm\* A - 28mm Lisa

BMW	750IL	V-12, 5.4 L	2000 - 1998
-----	-------	-------------	-------------



## Aplicación por Producto

### 38069



Termoplástico D.E. 80mm D.B. 10.2mm A - 37mm Lisa

BMW	330XI	6 CIL, 3.0 L	2005	-	2001
BMW	Z3	6 CIL, 2.8 L	1998	-	1998
BMW	Z4	6 CIL, 3.0 L	2005	-	2003
BMW	M3	6 CIL, 3.2 L	2002	-	2001
BMW	Z3	6 CIL, 3.2 L	1998	-	1998
BMW	X5	6 CIL, 3.0 L	2005	-	2005
BMW	Z4	6 CIL, 2.5 L	2005	-	2003
BMW	530I	6 CIL, 3.0 L	2002	-	2002
BMW	X3	6 CIL, 3.0 L	2006	-	2005
BMW	525I	6 CIL, 2.5 L	2005	-	2001
BMW	330CI	6 CIL, 3.0 L	2003	-	2001
BMW	325XI	6 CIL, 2.5 L	2005	-	2004

### 38070



Termoplástico D.E. 80mm D.B. 8mm A - 21mm Lisa

BMW	Z3	4 CIL, 1.9 L	1998	-	1998
BMW	Z3	6 CIL, 3.2 L	1998	-	1998
BMW	318TI	4 CIL, 1.9 L	1999	-	1998
BMW	318I	4 CIL, 1.9 L	1998	-	1998

### 38071



Termoplástico D.E. 70mm D.B. 24.5mm\* A - 24.5mm Lisa

BMW	530I	6 CIL, 3.0 L	2002	-	2002
BMW	330XI	6 CIL, 3.0 L	2005	-	2001
BMW	Z3	6 CIL, 3.2 L	1998	-	1998
BMW	X5	6 CIL, 3.0 L	2006	-	2006
BMW	320I	V-6, 2.2 L	2005	-	2004
BMW	318TI	4 CIL, 1.9 L	1999	-	1998
BMW	318I	4 CIL, 1.9 L	1998	-	1998
BMW	X5	6 CIL, 3.0 L	2005	-	2005

BMW	328I	V-6, 2.8 L	2000	-	2000
BMW	Z3	6 CIL, 2.8 L	1998	-	1998
BMW	X3	6 CIL, 3.0 L	2006	-	2005
BMW	330CI	6 CIL, 3.0 L	2003	-	2001
BMW	M3	6 CIL, 3.2 L	2002	-	2001
BMW	325XI	6 CIL, 2.5 L	2005	-	2004
BMW	525I	6 CIL, 2.5 L	2005	-	2001

### 38082



Termoplástico D.E. 63.5mm D.B. 17 mm A - 26.5mm V-Rz

MERCEDES BE	E55	V-8, 5.5 L	2002	-	2001
CHRYSLER	300 C	V-6, 3.5 L	2007	-	2009
MERCEDES BE	C320	V-6, 3.2 L	2005	-	2001
MERCEDES BE	C280	V-6, 2.8 L	2000	-	1998
MERCEDES BE	C240	V-6, 2.6 L	2005	-	2001
MERCEDES BE	SLK320	V-6, 3.2 L	2004	-	2001
MERCEDES BE	C43	V-8, 4.3 L	2000	-	1999
MERCEDES BE	ML320	V-6, 3.2 L	2003	-	2001
MERCEDES BE	ML430	V-8, 4.3 L	2001	-	2001
DODGE	CHARGER	V-6, 3.5 L	2009	-	2009
MERCEDES BE	CL500	V-8, 5.0 L	2005	-	2000
DODGE	CHARGER	V-6, 3.5 L	2008	-	2007
CHRYSLER	CROSSFIRE	V-6, 3.2 L	2005	-	2004
MERCEDES BE	SLK350	V-6, 3.5 L	2005	-	2005
MERCEDES BE	S55	V-8, 5.5 L	2002	-	2001
MERCEDES BE	CLK55	V-8, 5.5 L	2005	-	2002
MERCEDES BE	CLK500	V-8, 5.0 L	2005	-	2003
MERCEDES BE	S430	V-8, 4.3 L	2005	-	2001
MERCEDES BE	S500	V-8, 5.0 L	2005	-	2001
MERCEDES BE	CLK320	V-6, 3.2 L	2005	-	2001
MERCEDES BE	E320	V-6, 3.2 L	2006	-	2001
MERCEDES BE	SL500	V-8, 5.0 L	2005	-	2001
MERCEDES BE	E430	V-8, 4.3 L	2001	-	2001
MERCEDES BE	CL55	V-8, 5.5 L	2006	-	2001
MERCEDES BE	CLK430	V-8, 4.3 L	2003	-	2000

### 38083



Termoplástico D.E. 64mm D.B. 8.2mm A - 23mm V-Ranur

SAAB	9 - 5	4 CIL, 2.3 L	2000	-	2000
------	-------	--------------	------	---	------

**38087**



Termoplástico D.E. 78mm D.B. 9mm A - 25mm Lisa

VOLKSWAGEN	GOLF	4 CIL, 2.0 L	2000	-	1995
VOLKSWAGEN	PASSAT	4 CIL, 2.0 L	1996	-	1995
VOLKSWAGEN	CABRIO	4 CIL, 2.0 L	2002	-	1995
VOLKSWAGEN	JETTA	4 CIL, 2.0 L	2000	-	1994

**38090**

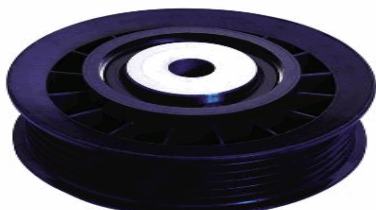

Termoplástico D.E. 63.5mm D.B. 14.5mm\* A - 31mm V-Rz

MERCEDES BE	SL600	V-12, 6.0 L	2001	-	2001
-------------	-------	-------------	------	---	------

**38093**



Termoplástico D.E. 85mm D.B. 14.5mm\* A - 30mm Lisa

AUDI	A8	V-8, 4.2 L	2000	-	1999
AUDI	A8 QUATTRO	V-8, 4.2 L	2000	-	1999
AUDI	A8	V-8, 3.7 L	1998	-	1998
AUDI	A8	V-8, 3.7 L	1999	-	1999
AUDI	A8	V-8, 4.2 L	2006	-	2001

**38099**

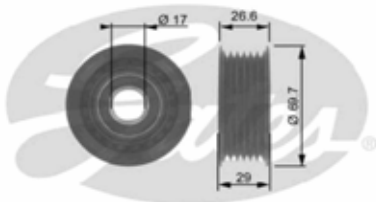

Termoplástico D.E. 69.7mm D.B. 17mm A - 29mm V-Ran

MERCEDES BE	SPRINTER	5 CIL, 2.7 L CDI	2005	-	2003
MERCEDES BE	SPRINTER	4 CIL, 2.2 L CDI	2008	-	2010
MERCEDES BE	VITO	4 CIL, 2.2 L	2008	-	2010

MERCEDES BE SPRINTER 4 CIL, 2.2 L CDI 2007 - 2006

**38102**

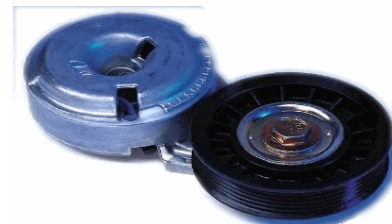

FORD	AEROSTAR	V-6, 4.0 L	1997	-	1996
FORD	EXPLORER	V-6, 4.0 L	2000	-	1995
LAND ROVER	DISCOVERY	V-8, 4.0 L	2000	-	2004
FORD	RANGER	V-6, 4.0 L	2000	-	1999

**38103**



CHEVROLET	SUBURBAN	V-8, 7.4 L	1999	-	1996
CHEVROLET	EXPRESS	V-6, 4.3 L	2003	-	1996
CHEVROLET	EXPRESS CARGO VAN	V-6, 4.3 L	2006	-	2005
CHEVROLET	SUBURBAN	V-8, 5.7 L	1999	-	1996
CHEVROLET	EXPRESS CARGO VAN	V-6, 4.3 L	2007	-	2010
CHEVROLET	EXPRESS	V-8, 5.7 L	2002	-	1996
CHEVROLET	EXPRESS	V-8, 7.4 L	2000	-	1996
CHEVROLET	S-10	V-6, 4.3 L	2002	-	1996
CHEVROLET	C-3500	V-8, 5.7 L	2000	-	1996
CHEVROLET	EXPRESS	V-8, 5.0 L	2002	-	1996
CHEVROLET	SILVERADO	V-6, 4.3 L	2007	-	2010
CHEVROLET	C y K SERIES PICKUP	V-8, 7.4 L	2000	-	1999
CHEVROLET	C y K SERIES PICKUP	V-8, 5.0 L	1999	-	1997
CHEVROLET	BLAZER	V-6, 4.3 L	2005	-	2005
CHEVROLET	C y K SERIES PICKUP	V-6, 4.3 L	1998	-	1996
CHEVROLET	C y K SERIES PICKUP	V-8, 5.7 L	2000	-	1996
CADILLAC	ESCALADE	V-8, 5.7 L	2000	-	1999
CHEVROLET	BLAZER	V-6, 4.3 L	2004	-	1996
CHEVROLET	C-2500	V-8, 5.7 L	2000	-	1996



## Aplicación por Producto

**38104**



CHEVROLET	MALIBU	V-6, 3.5 L	2006	-	2004
CHEVROLET	EQUINOX	V-6, 3.4 L	2007	-	2005
CHEVROLET	CUTLASS	V-6, 3.1 L	1998	-	1997
PONTIAC	TORRENT	V-6, 3.4 L	2008	-	2006
PONTIAC	MONTANA	V-6, 3.5 L	2006	-	2006
PONTIAC	GRAND AM	V-6, 3.4 L	2005	-	1999
CHEVROLET	MALIBU	V-6, 3.1 L	2003	-	1997
CHEVROLET	UPLANDER	V-6, 3.5 L	2007	-	2005
PONTIAC	G6	V-6, 3.9 L	2006	-	2006
PONTIAC	G6	V-6, 3.5 L	2006	-	2006
PONTIAC	AZTEK	V-6, 3.4 L	2005	-	2001
CHEVROLET	VENTURE	V-6, 3.4 L	2005	-	1999

**38105**



CHEVROLET	VENTURE	V-6, 3.4 L	1998	-	1997
OLDSMOBILE	SILHOUETTE	V-6, 3.4 L	1996	-	1996
CHEVROLET	IMPALA	V-6, 3.4 L	2003	-	2003
PONTIAC	GRAND AM	V-6, 3.1 L	1997	-	1997
CHEVROLET	LUMINA	V-6, 3.1 L	1997	-	1996
PONTIAC	GRAND PRIX	V-6, 3.1 L	2002	-	1997
CHEVROLET	CAVALIER	V-6, 3.1 L	1994	-	1993
CHEVROLET	IMPALA	V-6, 3.4 L	2005	-	2000
CHEVROLET	CENTURY	V-6, 3.1 L	1999	-	1994
CHEVROLET	LUMINA	V-6, 3.4 L	1995	-	1993
CHEVROLET	MONTE CARLO	V-6, 3.4 L	2005	-	2004
CHEVROLET	CUTLASS	V-6, 3.1 L	1996	-	1993

**38108**



CHEVROLET	BLAZER	V-6, 4.3 L	1995	-	1993
CHEVROLET	S-10	V-6, 4.3 L	1995	-	1993
CHEVROLET	C y K SERIES PICKUP	V-6, 4.3 L	1995	-	1995
CHEVROLET	C-3500	V-8, 5.7 L	1995	-	1994
CHEVROLET	C-35	V-8, 5.7 L	1993	-	1993
CHEVROLET	C-2500	V-8, 5.7 L	1995	-	1993
CHEVROLET	C y K SERIES PICKUP	V-8, 5.7 L	1995	-	1993
CHEVROLET	SUBURBAN	V-8, 5.7 L	1995	-	1993

**38109**

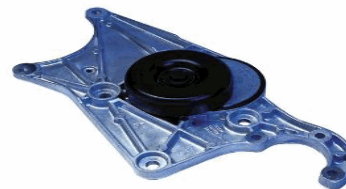

CHEVROLET	CAVALIER	4 CIL, 2.2 L	1994	-	1993
-----------	----------	--------------	------	---	------

**38110**



CHEVROLET	CAVALIER	4 CIL, 2.2 L	1997	-	1995
PONTIAC	SUNFIRE	4 CIL, 2.2 L	1997	-	1995

**38113**

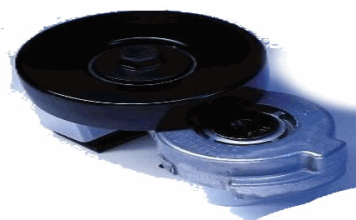

CHRYSLER	NEW YORKER	V-6, 3.8 L	1993	-	1993
CHRYSLER	GRAND VOYAGER	V-6, 3.8 L	1999	-	1994
CHRYSLER	NEW YORKER	V-6, 3.3 L	1993	-	1993
DODGE	ADVENTURER	V-6, 3.3 L	2000	-	1993
CHRYSLER	GRAND VOYAGER	V-6, 3.3 L	2000	-	2000
CHRYSLER	TOWN & COUNTRY	V-6, 3.8 L	2000	-	1995
CHRYSLER	VOYAGER	V-6, 3.3 L	2000	-	1996
CHRYSLER	VOYAGER	V-6, 3.8 L	1999	-	1999
DODGE	CARAVAN	V-6, 3.3 L	2000	-	1995

### 38114



FORD	RANGER	V-6, 3.0 L	2002 - 1996
FORD	WINDSTAR	V-6, 3.0 L	1998 - 1998
FORD	AEROSTAR	V-6, 3.0 L	1997 - 1995
MERCURY	SABLE / TAURUS	V-6, 3.0 L	2005 - 1996

### 38118

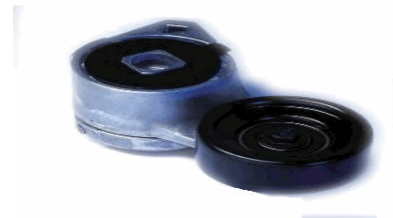

CHEVROLET	C y K SERIES PICKUP	V-8, 6.5 L	2002 - 1999
CHEVROLET	EXPRESS	V-8, 6.5 L	2002 - 1999

### 38116



DODGE	RAM WAGON 1500	V-8, 5.2 L	2001 - 1997
DODGE	RAM SERIES PICKUP	V-8, 5.9 L	2002 - 1994
DODGE	RAM MAXI VAN 3500	V-8, 5.9 L	2002 - 1996
DODGE	RAM WAGON 2500	V-8, 5.9 L	1995 - 1994
DODGE	RAM SERIES PICKUP	V-8, 5.2 L	2001 - 1995
DODGE	RAM WAGON 3500	V-8, 5.9 L	2002 - 2002
DODGE	RAM SERIES PICKUP	V-6, 3.9 L	2001 - 1994
DODGE	RAM MAXI WAGON 3500	V-8, 5.9 L	2002 - 1996
DODGE	RAM MAXI WAGON 3500	V-8, 5.2 L	1996 - 1996
DODGE	RAM WAGON 2500	V-8, 5.2 L	2001 - 1997
DODGE	RAM MAXI VAN 2500	V-8, 5.2 L	2002 - 1996
DODGE	RAM MAXI VAN 1500	V-6, 3.9 L	2002 - 1999
DODGE	RAM CHARGER	V-8, 5.9 L	1993 - 1993
DODGE	RAM 4000	V-8, 5.9 L	2002 - 1995
DODGE	RAM 3500	V-8, 5.9 L	2002 - 1994
DODGE	RAM 2500	V-8, 5.9 L	2002 - 1994
DODGE	RAM 2500	V-8, 5.2 L	2001 - 1997
DODGE	RAM 1500	V-6, 3.9 L	2001 - 1994
DODGE	DURANGO	V-8, 5.9 L	2003 - 1998
DODGE	DURANGO	V-8, 5.2 L	2000 - 1998
DODGE	DURANGO	V-6, 3.9 L	1999 - 1998
DODGE	D-350	V-8, 5.9 L	1993 - 1993
DODGE	D-150	V-6, 3.9 L	1993 - 1993
JEEP	GRAND CHEROKEE	V-8, 5.9 L	1998 - 1998
JEEP	GRAND CHEROKEE	V-8, 5.2 L	1998 - 1993
DODGE	D-250	V-8, 5.9 L	1993 - 1993

### 38119



FORD	E SERIES VAN	V-8, 7.3 L	1997 - 1997
------	--------------	------------	-------------

### 38122

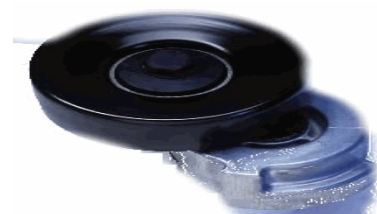

DODGE	SPIRIT	V-6, 3.0 L	1994 - 1994
DODGE	CARAVAN	V-6, 3.0 L	1995 - 1995
CHRYSLER	LEBARON	V-6, 3.0 L	1995 - 1993
CHRYSLER	VOYAGER	V-6, 3.0 L	2000 - 2000

### 38123



FORD	F-350 SUPER DUTY	V-8, 5.0 L	1996 - 1993
FORD	F SERIES PICKUP	V-8, 5.8 L	1997 - 1995
FORD	F SERIES PICKUP	V-8, 5.0 L	1996 - 1995
FORD	F-350 SUPER DUTY	V-8, 5.8 L	1997 - 1993
FORD	F-250	V-8, 5.0 L	1996 - 1993

### 38126

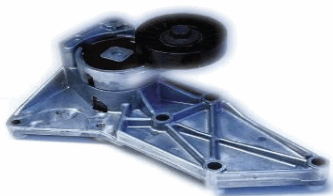

OLDSMOBILE	SILHOUETTE	V-6, 3.8 L	1995 - 1994
CHEVROLET	REGAL	V-6, 3.8 L	1995 - 1994
PONTIAC	BONNEVILLE	V-6, 3.8 L	1994 - 1994
OLDSMOBILE	SILHOUETTE	V-6, 3.1 L	1994 - 1994

### 38127

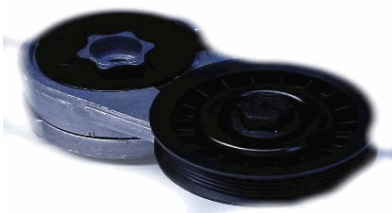

FORD	MUSTANG	V-6, 3.8 L	2001 - 1996
MERCURY	COUGAR XR7	V-6, 3.8 L	1994 - 1993
FORD	THUNDERBIRD	V-6, 3.8 L	1994 - 1994

### 38129



FORD	ESCORT	4 CIL, 1.9 L	1996 - 1994
------	--------	--------------	-------------

### 38131



FORD	E SERIES VAN	6 CIL, 4.9 L	1996 - 1995
FORD	F-150	V-6, 4.9 L	1996 - 1995
FORD	F SERIES PICKUP	V-6, 4.9 L	1996 - 1995

### 38132



LINCOLN	MARK VIII	V-8, 4.6 L	1998 - 1994
FORD	THUNDERBIRD	V-8, 4.6 L	1997 - 1994
FORD	CROWN VICTORIA	V-8, 4.6 L	1999 - 1996
MERCURY	GRAND MARQUIS	V-8, 4.6 L	1999 - 1993
FORD	MUSTANG	V-8, 4.6 L	1999 - 1996
LINCOLN	TOWN CAR	V-8, 4.6 L	1999 - 1993

### 38133



FORD	LOBO	V-8, 5.4 L	2002 - 2002
FORD	EXCURSION	V-8, 5.4 L	2001 - 2000
FORD	EXCURSION	V-10, 6.8 L	2003 - 2000
FORD	E SERIES VAN	V-8, 4.6 L	2001 - 1999
FORD	SUPER DUTY VAN	V-8, 5.4 L	2001 - 1999
FORD	SUPER DUTY PICKUP	V-10, 6.8 L	2002 - 1999
FORD	F SERIES PICKUP	V-10, 6.8 L	2000 - 1999
FORD	F SERIES PICKUP	V-8, 5.4 L	2002 - 1999
FORD	SUPER DUTY PICKUP	V-8, 5.4 L	2002 - 1999
FORD	SUPER DUTY VAN	V-10, 6.8 L	2001 - 1999
FORD	F SERIES PICKUP	V-8, 4.6 L	2001 - 1998
FORD	E SERIES VAN	V-10, 6.8 L	1998 - 1997
FORD	F-450 SUPER DUTY	V-10, 6.8 L	2006 - 1999
FORD	F-250	V-8, 4.6 L	2001 - 1998
FORD	EXPEDITION	V-8, 5.4 L	2002 - 1997
FORD	F-350 SUPER DUTY	V-8, 5.4 L	2006 - 1999
FORD	EXPEDITION	V-8, 4.6 L	2002 - 1997
LINCOLN	NAVIGATOR	V-8, 5.4 L	2002 - 1998
FORD	E SERIES VAN	V-8, 5.4 L	2002 - 1997

38134



FORD	AEROSTAR	V-6, 4.0 L	1995	-	1993
------	----------	------------	------	---	------

38136



CHEVROLET	SILVERADO	V-8, 6.6 L	2001	-	2001
-----------	-----------	------------	------	---	------

38137

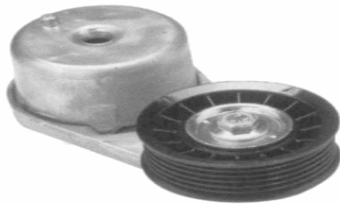

FORD	EXPLORER	V-6, 4.0 L	2007	-	2010
FORD	EXPLORER SPORT TRAC	V-6, 4.0 L	2006	-	2010
FORD	RANGER	V-6, 4.0 L	2001	-	2001

38138



FORD	F-150	V-6, 4.2 L	2007	-	2008
FORD	SUPER DUTY VAN	V-6, 4.2 L	2001	-	2001
FORD	F SERIES PICKUP	V-6, 4.2 L	2002	-	1998
FORD	E SERIES VAN	V-6, 4.2 L	2003	-	1997

38139

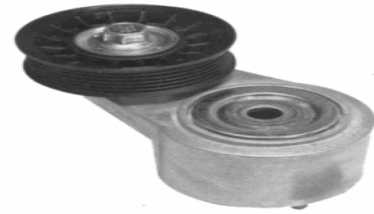

MERCURY	SABLE / TAURUS	V-6, 3.8 L	1995	-	1993
FORD	WINDSTAR	V-6, 3.8 L	1998	-	1995

38140



FORD	F SERIES PICKUP	V-8, 7.5 L	1997	-	1997
FORD	F-450 SUPER DUTY	V-8, 7.5 L	1997	-	1997

38143



CHEVROLET	SUBURBAN	V-8, 7.4 L	1993	-	1993
-----------	----------	------------	------	---	------

38145



PONTIAC	FIREBIRD TRANS AM	V-8, 5.7 L	1997	-	1997
CHEVROLET	CAMARO Z28	V-8, 5.7 L	1997	-	1996

## Aplicación por Producto

**38146**



CHEVROLET	CAVALIER	4 CIL, 2.3 L	1995 - 1995
CHEVROLET	CAVALIER	4 CIL, 2.4 L	1998 - 1996
PONTIAC	GRAND AM	4 CIL, 2.4 L	1999 - 1999
PONTIAC	SUNFIRE	4 CIL, 2.4 L	1998 - 1996
CHEVROLET	MALIBU	4 CIL, 2.4 L	1998 - 1997
PONTIAC	SUNFIRE	4 CIL, 2.3 L	1995 - 1995

**38147**

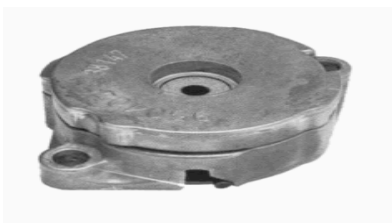

VOLKSWAGEN	GOLF	4 CIL, 2.0 L	2000 - 1994
VOLKSWAGEN	GTI	4 CIL, 2.0 L	2000 - 1999
VOLKSWAGEN	CABRIO	4 CIL, 2.0 L	2002 - 1995
VOLKSWAGEN	PASSAT	4 CIL, 2.0 L	1996 - 1993
VOLKSWAGEN	JETTA	4 CIL, 2.0 L	2000 - 1994

**38148**



VOLKSWAGEN	BEETLE	4 CIL, 1.8 L	2005 - 1999
SEAT	IBIZA	4 CIL, 2.0 L	2003 - 2009
SEAT	CORDOBA	4 CIL, 2.0 L	2003 - 2007
AUDI	TT	4 CIL, 1.8 L	2006 - 2000
VOLKSWAGEN	JETTA	4 CIL, 2.0 L	2008 - 2010
VOLKSWAGEN	JETTA	4 CIL, 1.8 L	2006 - 2000
VOLKSWAGEN	GOLF	4 CIL, 1.8 L	2006 - 2000
VOLKSWAGEN	JETTA	4 CIL, 1.9 L DIESE	2005 - 2004
SEAT	AHLAMBRA	4 CIL, 1.8 L	2007 - 2003
VOLKSWAGEN	BEETLE	4 CIL, 2.0 L	2008 - 1998
AUDI	TT	4 CIL, 1.8 L	2005 - 2001
SEAT	TOLEDO	4 CIL, 1.8 L	2005 - 2003
VOLKSWAGEN	GOLF	4 CIL, 2.0 L	2006 - 1999

VOLKSWAGEN	SHARAN	4 CIL, 1.8 L	2007 - 2003
VOLKSWAGEN	PASSAT	4 CIL, 2.0 L	2006 - 2006
SEAT	LEON	4 CIL, 1.8 L	2005 - 2003

**38150**

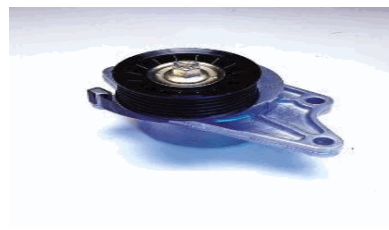

FORD	FREESTAR	V-6, 4.2 L	2005 - 2004
FORD	FREESTAR	V-6, 3.9 L	2005 - 2004
FORD	WINDSTAR	V-6, 3.8 L	2003 - 1999

**38151**

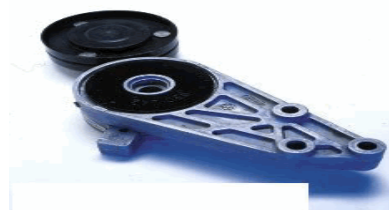

VOLKSWAGEN	PASSAT	4 CIL, 1.8 L	2005 - 1999
AUDI	A4	4 CIL, 1.8 L	2002 - 1998

**38152**



CHEVROLET	REGAL	V-6, 3.8 L	1996 - 1996
OLDSMOBILE	EIGHTY EIGHT	V-6, 3.8 L	1998 - 1998
CHEVROLET	LUMINA	V-6, 3.8 L	1998 - 1998
PONTIAC	BONNEVILLE	V-6, 3.8 L	1998 - 1995
PONTIAC	GRAND PRIX	V-6, 3.8 L	1998 - 1997

**38153**





## Aplicación por Producto

CADILLAC	SEVILLE	V-8, 4.6 L	2004 - 1998
CADILLAC	EL DORADO	V-8, 4.6 L	1999 - 1994
CADILLAC	EL DORADO	V-8, 4.6 L	2002 - 2000
CADILLAC	DTS	V-8, 4.6 L	2007 - 2006
CADILLAC	DEVILLE	V-8, 4.6 L	2005 - 1998

### 38155



FORD	RANGER	4 CIL, 2.3 L	2007 - 2010
FORD	RANGER	4 CIL, 2.5 L	2001 - 1998

### 38156



SUZUKI	AERIO	4 CIL, 2.3 L	2006 - 2005
CHEVROLET	TRACKER	4 CIL, 2.0 L	2003 - 1999
SUZUKI	SX4	4 CIL, 2.0 L	2008 - 2010

### 38157



DODGE	RAM SERIES PICKUP	6 CIL, 5.9 L Diesel	2002 - 1999
-------	-------------------	---------------------	-------------

### 38158



CHEVROLET	SILVERADO	V-8, 6.0 L	2007 - 2000
GMC	SIERRA	V-8, 6.2 L	2008 - 2007

GMC	YUKON	V-8, 5.3 L	2008 - 2007
CHEVROLET	SUBURBAN	V-8, 5.3 L	2007 - 2008
CHEVROLET	SILVERADO	V-8, 5.3 L	2007 - 2008
CADILLAC	ESCALADE	V-8, 5.3 L	2004 - 2002
CHEVROLET	SILVERADO	V-8, 4.8 L	2007 - 2008
HUMMER	H2	V-8, 6.0 L	2007 - 2005
GMC	YUKON	V-8, 6.2 L	2008 - 2007
CADILLAC	ESCALADE	V-8, 6.2 L	2007 - 2007
CADILLAC	ESCALADE	V-8, 6.0 L	2006 - 2002
CADILLAC	ESCALADE	V-8 6.2 L	2008 - 2008
HUMMER	H2	V-8, 6.2 L	2008 - 2008
CHEVROLET	EXPRESS	V-8, 5.3 L	2007 - 2008
CHEVROLET	TAHOE	V-8, 4.8 L	2007 - 2006
CHEVROLET	TAHOE	V-8, 5.3 L	2007 - 2008
CHEVROLET	AVALANCHE	V-8, 5.3 L	2007 - 2008
CHEVROLET	AVALANCHE	V-8, 5.3 L	2006 - 2006
CHEVROLET	TRAILBLAZER	V-8, 5.3 L	2007 - 2003
CHEVROLET	SUBURBAN	V-8, 6.0 L	2007 - 2008
CHEVROLET	TRAILBLAZER	V-8, 6.0 L	2006 - 2006
CHEVROLET	EXPRESS	V-8, 6.0 L	2007 - 2008

### 38159



CADILLAC	ESCALADE	V-8, 6.2 L	2007 - 2007
HUMMER	H2	V-8, 6.0 L	2007 - 2005
HUMMER	H2	V-8, 6.2 L	2008 - 2008
CHEVROLET	TRAILBLAZER	V-8, 6.0 L	2006 - 2006
GMC	SIERRA	V-8, 6.2 L	2008 - 2007
CHEVROLET	SILVERADO	V-8, 6.0 L	2007 - 2000
CHEVROLET	SUBURBAN	V-8, 6.0 L	2007 - 2008
CHEVROLET	EXPRESS	V-8, 5.3 L	2007 - 2008
CADILLAC	ESCALADE	V-8, 6.0 L	2006 - 2002
CHEVROLET	SILVERADO	V-8, 5.3 L	2007 - 2008
CHEVROLET	SILVERADO	V-8, 4.8 L	2007 - 2008
CHEVROLET	AVALANCHE	V-8, 5.3 L	2006 - 2006
CHEVROLET	AVALANCHE	V-8, 5.3 L	2007 - 2008
CHEVROLET	TAHOE	V-8, 5.3 L	2007 - 2008
CHEVROLET	TAHOE	V-8, 4.8 L	2007 - 2006
CHEVROLET	TRAILBLAZER	V-8, 5.3 L	2007 - 2003
CADILLAC	ESCALADE	V-8 6.2 L	2008 - 2008
GMC	YUKON	V-8, 6.2 L	2008 - 2007
CHEVROLET	SUBURBAN	V-8, 5.3 L	2007 - 2008
CADILLAC	ESCALADE	V-8, 5.3 L	2004 - 2002
CHEVROLET	EXPRESS	V-8, 6.0 L	2007 - 2008
GMC	YUKON	V-8, 5.3 L	2008 - 2007



**38160**



FORD	CONTOUR	4 CIL, 2.0 L	1997 - 1995
MERCURY	MYSTIQUE	4 CIL, 2.0 L	1997 - 1995

**38164**

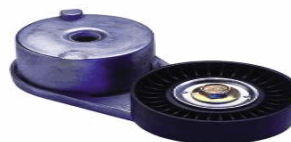

CHEVROLET	CAVALIER	4 CIL, 2.2 L	2002 - 1998
PONTIAC	SUNFIRE	4 CIL, 2.2 L	2002 - 1998

**38161**



FORD	EXPLORER	V-8, 5.0 L	2001 - 1998
------	----------	------------	-------------

**38165**



CHEVROLET	S-10	4 CIL, 2.2 L	2002 - 2002
CHEVROLET	S-10	4 CIL, 2.2 L	2001 - 1998

**38162**



FORD	ESCORT	4 CIL, 2.0 L	2002 - 1998
FORD	ZX2	4 CIL, 2.0 L	2003 - 2001

**38167**



**38163**



JEEP	WRANGLER	6 CIL, 4.0 L	2006 - 2000
JEEP	GRAND CHEROKEE	6 CIL, 4.0 L	2002 - 1999

JEEP	GRAND CHEROKEE	V-6, 3.7 L	2007 - 2005
JEEP	GRAND CHEROKEE	V-8, 4.7 L	2007 - 1999
JEEP	LIBERTY	V-6, 3.7 L	2007 - 2002
DODGE	RAM 2500	V-8, 4.7L	2003 - 2002
DODGE	RAM 1500	V-6, 3.7 L	2005 - 2004
DODGE	NITRO	V-6, 3.7 L	2008 - 2007
DODGE	DURANGO	V-6, 3.7 L	2004 - 2004
DODGE	DURANGO	V-6, 3.7 L	2005 - 2005
DODGE	RAM SERIES PICKUP	V-6, 3.7 L	2003 - 2002
DODGE	DAKOTA	V-6, 3.7 L	2008 - 2007
DODGE	DURANGO	V-8, 4.7 L	2006 - 2000

## Aplicación por Producto

**38168**



TOYOTA	4 RUNNER	V-8, 4.7 L	2007	-	2003
TOYOTA	TUNDRA	V-8, 4.7 L	2008	-	2007
TOYOTA	LAND CRUISER	V-8, 4.7 L	2007	-	2003
TOYOTA	SEQUOIA	V-8, 4.7 L	2008	-	2007

FORD	TOPAZ	4 CIL, 2.3 L	1994	-	1994
------	-------	--------------	------	---	------

**38169**



HONDA	ODYSSEY	V-6, 3.5 L	2000	-	1999
HONDA	ACCORD	V-6, 3.0 L	2002	-	1998

**38171**



FORD	ESCORT	4 CIL, 2.0 L	2002	-	1997
------	--------	--------------	------	---	------

**38172**



HUMMER	H1	V-8, 6.6 L	2007	-	2006
--------	----	------------	------	---	------

**38173**

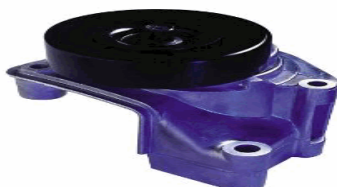

**38174**



MERCEDES BE	CL500	V-8, 5.0 L	2005	-	2000
MERCEDES BE	S500	V-8, 5.0 L	2005	-	2001
MERCEDES BE	SLK320	V-6, 3.2 L	2004	-	2001
MERCEDES BE	SL55	V-8, 5.5 L	2006	-	2003
MERCEDES BE	S430	V-8, 4.3 L	2005	-	2001
MERCEDES BE	SL500	V-8, 5.0 L	2005	-	2001
MERCEDES BE	E55	V-8, 5.5 L	2002	-	2001
MERCEDES BE	E430	V-8, 4.3 L	2001	-	2001
MERCEDES BE	CLK55	V-8, 5.5 L	2006	-	2001
MERCEDES BE	S55	V-8, 5.5 L	2005	-	2001
MERCEDES BE	CLK500	V-8, 5.0 L	2005	-	2003
MERCEDES BE	CLK430	V-8, 4.3 L	2003	-	2000
MERCEDES BE	CLK320	V-6, 3.2 L	2005	-	2001
MERCEDES BE	CL55	V-8, 5.5 L	2006	-	2001
MERCEDES BE	C240	V-6, 2.6 L	2005	-	2001
MERCEDES BE	C280	V-6, 2.8 L	2000	-	1998
MERCEDES BE	C320	V-6, 3.2 L	2005	-	2001
MERCEDES BE	C43	V-8, 4.3 L	2000	-	1999
MERCEDES BE	E320	V-6, 3.2 L	2006	-	2001
MERCEDES BE	ML320	V-6, 3.2 L	2003	-	2001
MERCEDES BE	ML430	V-8, 4.3 L	2001	-	2001
CHRYSLER	CROSSFIRE	V-6, 3.2 L	2005	-	2004

**38175**

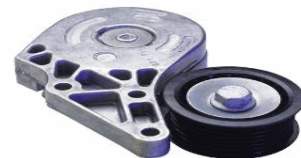

VOLKSWAGEN	GOLF	V-6, 2.8 L	2000	-	1995
VOLKSWAGEN	GTI	V-6, 2.8 L	2001	-	1999
VOLKSWAGEN	JETTA	V-6, 2.8 L	2004	-	1995
VOLKSWAGEN	PASSAT	V-6, 2.8 L	1997	-	1995

### 38176



GMC	CANYON	4 CIL, 2.9 L	2007 - 2007
HUMMER	H3	5 CIL, 3.5 L	2007 - 2006
CHEVROLET	TRAILBLAZER	6 CIL, 4.2 L	2007 - 2002
CHEVROLET	COLORADO	5 CIL, 3.5 L	2005 - 2004
CHEVROLET	COLORADO	4 CIL, 2.8 L	2006 - 2005

### 38179



CHRYSLER	PT CRUISER	4 CIL, 2.4 L	2007 - 2010
DODGE	NEON	4 CIL, 2.4 L	2004 - 2004

### 38177

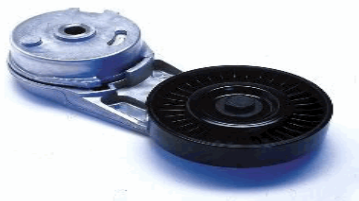

CADILLAC	CATERA	V-6, 3.0 L	2001 - 1998
CADILLAC	CTS	V-6, 3.2 L	2004 - 2003
SAAB	9 - 5	V-6, 3.0 L	2003 - 2000
SAAB	9 - 5	V-6, 3.0 L	2002 - 2002

### 38180



PONTIAC	SOLSTICE	4 CIL, 2.4 L	2008 - 2006
CHEVROLET	VECTRA	V-6, 2.8 L	2008 - 2007
CHEVROLET	CAVALIER	4 CIL, 2.2 L	2005 - 2002
SAAB	9 - 3	4 CIL, 2.0 L	2007 - 2003
CHEVROLET	MALIBU	4 CIL, 2.2 L	2007 - 2004
CHEVROLET	MALIBU	4 CIL, 2.4 L	2008 - 2010
CHEVROLET	CAPTIVA	4 CIL, 2.4 L	2008 - 2008
PONTIAC	G4	4 CIL, 2.4 L	2006 - 2006
CHEVROLET	VECTRA	4 CIL, 2.2 L	2005 - 2003
CHEVROLET	HHR	4 CIL, 2.4 L	2008 - 2010
PONTIAC	G4	4 CIL, 2.2 L	2006 - 2006
PONTIAC	G5	4 CIL, 2.2 L	2008 - 2007
PONTIAC	SUNFIRE	4 CIL, 2.2 L	2005 - 2002
PONTIAC	G5	4 CIL, 2.4 L	2008 - 2007
CHEVROLET	CAPTIVA	4 CIL, 2.4 L	2009 - 2010
SAAB	9 - 3	4 CIL, 2.0 L	2006 - 2003
PONTIAC	GRAND AM	4 CIL, 2.2 L	2003 - 2002

DODGE	RAM SERIES PICKUP	V-10, 8.0 L	2000 - 1999
DODGE	RAM SERIES PICKUP	V-8, 5.9 L	2001 - 1997

### 38181



MERCURY	SABLE / TAURUS	V-6, 3.0 L	2000 - 1998
---------	----------------	------------	-------------

### 38178



### 38182



HUMMER	H3	5 CIL, 3.7 L	2008 - 2010
CHEVROLET	COLORADO	5 CIL, 3.7 L	2007 - 2010
CHEVROLET	COLORADO	4 CIL, 2.9 L	2007 - 2010
GMC	CANYON	5 CIL, 3.7 L	2008 - 2010
CHEVROLET	COLORADO	5 CIL, 3.5 L	2006 - 2006

FORD	MUSTANG	V-8, 5.0 L	1995 - 1994
------	---------	------------	-------------

**38185**



CHRYSLER	VOYAGER	V-6, 3.3 L	2007 - 2001
CHRYSLER	TOWN & COUNTRY	V-6, 3.8 L	2007 - 2005
JEEP	WRANGLER	4 CIL, 2.4 L	2006 - 2003
DODGE	CARAVAN	V-6, 3.3 L	2007 - 2002

**38189**



LINCOLN	TOWN CAR	V-8, 4.6 L	2006 - 2000
FORD	MUSTANG	V-8, 4.6 L	2004 - 2000
FORD	CROWN VICTORIA	V-8, 4.6 L	2004 - 2001
MERCURY	GRAND MARQUIS	V-8, 4.6 L	2005 - 2000

**38186**



FORD	ESCAPE	V-6, 3.0 L	2004 - 2001
MERCURY	SABLE / TAURUS	V-6, 3.0 L	2005 - 2003

**38190**



VOLVO	S80	5 CIL, 2.5 L	2006 - 2005
VOLVO	S60	5 CIL, 2.5 L	2006 - 2004
VOLVO	S80	6 CIL, 2.9 L	2005 - 2002
VOLVO	XC90	5 CIL, 2.5 L	2006 - 2003
VOLVO	C70	5 CIL, 2.3 L	2004 - 2004
VOLVO	C70	5 CIL, 2.4 L	2004 - 2004
VOLVO	S40	4 CIL, 1.9 L	2004 - 2002

**38187**

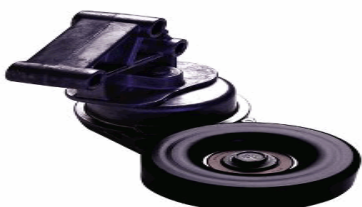

CHEVROLET	S-10	4 CIL, 2.2 L	1997 - 1997
CHEVROLET	S-10	4 CIL, 2.2 L	1996 - 1994

**38191**

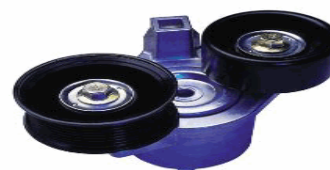

FORD	F-450 SUPER DUTY	V-8, 7.3 L	2003 - 2002
FORD	SUPER DUTY PICKUP	V-8, 7.3 L	2002 - 1999

**38188**

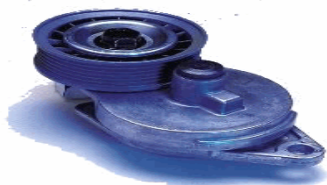

FORD	FOCUS	4 CIL, 2.0 L	2002 - 2002
FORD	FOCUS	4 CIL, 2.0 L	2003 - 2000
MERCURY	MYSTIQUE	4 CIL, 2.0 L	2000 - 1998
FORD	CONTOUR	4 CIL, 2.0 L	2000 - 1998
FORD	ESCAPE	4 CIL, 2.0 L	2002 - 2001

**38192**



VOLKSWAGEN	JETTA	4 CIL, 1.9 L DIESE	2004 - 2000
------------	-------	--------------------	-------------

CADILLAC DEVILLE V-8, 4.6 L 2005 - 1998

**38193**



AUDI	A6	V-6, 2.7 L	2000	-	2000
AUDI	A4	V-6, 2.8 L	1998	-	1998
AUDI	A4	V-6, 2.8 L	2000	-	1999
AUDI	S4 QUATTRO	V-6, 2.7 L	2002	-	2001
VOLKSWAGEN	PASSAT	V-6, 2.8 L	2005	-	1998
AUDI	A6	V-6, 2.8 L	2001	-	1998
AUDI	ALLROAD QUATTRO	V-6, 2.7 L	2006	-	2002
AUDI	S4 QUATTRO	V-6, 2.7 L	2000	-	2000

**38198**



CHEVROLET LUMINA V-6, 3.4 L 1997 - 1993

**38200**

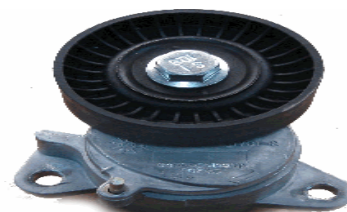

**38194**



CHEVROLET CORVETTE V-8, 5.7 L 2004 - 1997

**38196**



CHEVROLET CORVETTE V-8, 5.7 L 2004 - 1997

**38197**



CADILLAC	EL DORADO	V-8, 4.6 L	2002	-	1998
CADILLAC	SEVILLE	V-8, 4.6 L	2004	-	1998
CADILLAC	DTS	V-8, 4.6 L	2007	-	2006

CHEVROLET	CHEVY C2 SEDAN	4 CIL, 1.6 L	2008	-	2004
CHEVROLET	MONZA	4 CIL, 1.6 L	2004	-	1994
CHEVROLET	CHEVY	4 CIL, 1.6 L	2009	-	2010
CHEVROLET	CHEVY SWING	4 CIL, 1.6 L	2003	-	1994
CHEVROLET	CHEVY POP	4 CIL, 1.6 L	2003	-	1994
CHEVROLET	CHEVY C2	4 CIL, 1.6 L	2008	-	2004
CHEVROLET	TIGRA	4 CIL, 1.6 L	1999	-	1999
CHEVROLET	TIGRA	4 CIL, 1.6 L	2000	-	2000
CHEVROLET	ASTRA	4 CIL, 2.0 L	2008	-	2007
CHEVROLET	OPTRA	4 CIL, 2.0 L	2009	-	2010
CHEVROLET	CHEVY PICK-UP	4 CIL, 1.6 L	2006	-	2002
CHEVROLET	OPTRA	4 CIL, 2.0 L	2008	-	2006
CHEVROLET	CHEVY JOY	4 CIL, 1.6 L	2003	-	1994

**38201**



BMW	X5	6 CIL, 3.0 L	2005	-	2005
BMW	330XI	6 CIL, 3.0 L	2005	-	2001
BMW	325XI	6 CIL, 2.5 L	2005	-	2004
BMW	330CI	6 CIL, 3.0 L	2003	-	2001
BMW	X5	6 CIL, 3.0 L	2006	-	2006
BMW	530I	6 CIL, 3.0 L	2002	-	2002
BMW	Z4	6 CIL, 2.5 L	2005	-	2003
BMW	M3	6 CIL, 3.2 L	2001	-	2001



## Aplicación por Producto

BMW	X5	V-6, 3.0 L	2004	-	2004
BMW	328i	V-6, 2.8 L	2000	-	2000
BMW	Z4	6 CIL, 3.0 L	2005	-	2003
BMW	Z3	6 CIL, 2.8 L	1998	-	1998
BMW	X3	6 CIL, 3.0 L	2006	-	2005
BMW	525i	6 CIL, 2.5 L	2005	-	2001
BMW	528i	V-6, 2.8 L	2000	-	1998
BMW	Z4	V-6, 3.0 L	2004	-	2004
BMW	Z4	V-6, 2.5 L	2004	-	2004
BMW	Z4	V-6, 2.5 L	2006	-	2005
BMW	528i	V-6, 2.8 L	1999	-	1999

### 38218



BMW	X5	V-8, 4.4 L	2000	-	2000
BMW	540i	V-8, 4.4 L	2001	-	1998
BMW	M5	V-8, 5.0 L	2001	-	2000
BMW	740iL	V-8, 4.4 L	2001	-	1998
BMW	X5	V-8, 4.6 L	2002	-	2002
BMW	740i	V-8, 4.4 L	2001	-	1998

### 38204

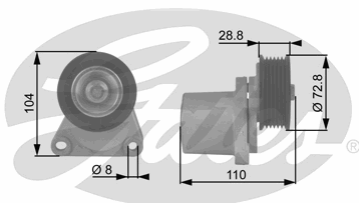

### 38219



FORD	ECOSPORT	4 CIL, 2.0 L	2003	-	2010
FORD	MONDEO	4 CIL, 2.0 L	2006	-	2003

### 38207



BMW	740iL	V-8, 4.4 L	2001	-	1998
BMW	740i	V-8, 4.4 L	2001	-	1998
BMW	M5	V-8, 5.0 L	2001	-	2000
BMW	X5	V-8, 4.6 L	2002	-	2002
BMW	X5	V-8, 4.4 L	2000	-	2000
BMW	540i	V-8, 4.4 L	2001	-	1998

AUDI	A4	4 CIL, 1.8 L	2004	-	2004
AUDI	A4	4 CIL, 2.0 L	2007	-	2007
AUDI	A4	4 CIL, 1.8 L	2006	-	2003

### 38220



### 38216



BMW	Z3	6 CIL, 2.8 L	1998	-	1998
-----	----	--------------	------	---	------

TOYOTA	RAV 4	4 CIL, 2.0 L	2003	-	2003
TOYOTA	CAMRY	4 CIL, 2.4 L	2006	-	2003
TOYOTA	RAV 4	4 CIL, 2.4 L	2007	-	2004

### 38221



BMW	Z3	6 CIL, 2.8 L	1998	-	1998
-----	----	--------------	------	---	------



## Aplicación por Producto

BMW	330XI	6 CIL, 3.0 L	2005	-	2001
BMW	530I	6 CIL, 3.0 L	2002	-	2002
BMW	X5	6 CIL, 3.0 L	2006	-	2006
BMW	Z3	6 CIL, 3.2 L	1998	-	1998
BMW	525I	6 CIL, 2.5 L	2005	-	2001
BMW	330CI	6 CIL, 3.0 L	2003	-	2001
BMW	325XI	6 CIL, 2.5 L	2005	-	2004
BMW	M3	6 CIL, 3.2 L	2002	-	2001
BMW	X3	6 CIL, 3.0 L	2006	-	2005
BMW	X5	V-6, 3.0 L	2004	-	2004
BMW	X5	6 CIL, 3.0 L	2005	-	2005

### 38226



SAAB	9-5	V-6, 3.0 L	2003	-	2003
SAAB	9-3	4 CIL, 2.0 L	2002	-	2002
SAAB	9-3	4 CIL, 2.3 L	2002	-	2000
SAAB	9-5	4 CIL, 2.3 L	2007	-	2002
SAAB	9-3	4 CIL, 2.3 L	2002	-	2001
SAAB	9-5	4 CIL, 2.3 L	2006	-	2000
SAAB	9-3	4 CIL, 2.0 L	2003	-	2000

### 38223



BMW	Z3	4 CIL, 1.9 L	1998	-	1998
BMW	318TI	4 CIL, 1.9 L	1999	-	1998
BMW	318I	4 CIL, 1.9 L	1998	-	1998

### 38239



FORD	E SERIES VAN	V-8, 4.6 L	2005	-	2005
------	--------------	------------	------	---	------

### 38224



### 38245



BMW	M3	6 CIL, 3.2 L	2002	-	2001
BMW	525I	6 CIL, 2.5 L	2002	-	2001
BMW	330XI	6 CIL, 3.0 L	2001	-	2001
BMW	530I	6 CIL, 3.0 L	2002	-	2002
BMW	328I	V-6, 2.8 L	2000	-	2000
BMW	528I	V-6, 2.8 L	1999	-	1999
BMW	330CI	6 CIL, 3.0 L	2002	-	2001
BMW	528I	V-6, 2.8 L	2000	-	2000

LAND ROVER	DISCOVERY	V-8, 4.0 L	2002	-	1999
LAND ROVER	RANGE ROVER	V-8, 4.0 L	2000	-	1998
LAND ROVER	DISCOVERY SERIES II	V-8, 4.0 L	2001	-	1999
LAND ROVER	RANGE ROVER	V-8, 4.6 L	2002	-	1998

### 38225



### 38246



MERCEDES BE	SLK230	4 CIL, 2.3 L	2004	-	2001
-------------	--------	--------------	------	---	------

LAND ROVER	DISCOVERY	V-8, 4.0 L	1999	-	1999
------------	-----------	------------	------	---	------

**38247**



PONTIAC	GRAND AM	4 CIL, 2.4 L	2001 - 2001
CHEVROLET	CAVALIER Z24	4 CIL, 2.4 L	2002 - 1998
PONTIAC	SUNFIRE	4 CIL, 2.4 L	2002 - 1999
CHEVROLET	CAVALIER	4 CIL, 2.4 L	1999 - 1999

**38259**



CHEVROLET	SUBURBAN	V-8, 8.1 L	2006 - 2001
CHEVROLET	AVALANCHE	V-8, 8.1 L	2002 - 2002

**38250**



FORD	CONTOUR	V-6, 2.5 L	2000 - 1995
MERCURY	MYSTIQUE	V-6, 2.5 L	2000 - 1995

**38260**



CHEVROLET	AVALANCHE	V-8, 8.1 L	2002 - 2002
CHEVROLET	SUBURBAN	V-8, 8.1 L	2006 - 2001

**38251**



LINCOLN	CONTINENTAL	V-8, 4.6 L	2002 - 1997
---------	-------------	------------	-------------

**38268**

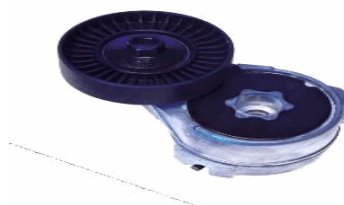

PONTIAC	BONNEVILLE	V-6, 3.8 L	1995 - 1994
---------	------------	------------	-------------

**38258**



CHEVROLET	EXPRESS	V-8, 8.1 L	2002 - 2001
CHEVROLET	C y K SERIES PICKUP	V-8, 8.1 L	2002 - 2001

**38269**



PONTIAC	BONNEVILLE	V-6, 3.8 L	1995 - 1995
---------	------------	------------	-------------

**38271**



PONTIAC	GRAND PRIX	V-6, 3.8 L	2005	-	2003
PONTIAC	BONNEVILLE	V-6, 3.8 L	2005	-	2003
CHEVROLET	IMPALA	V-6, 3.8 L	2003	-	2003
CHEVROLET	IMPALA	V-6, 3.8 L	2005	-	2000

**38275**



FORD	FOCUS	4 CIL, 2.0 L	2004	-	2000
------	-------	--------------	------	---	------

**38276**



FORD	ESCAPE	V-6, 3.0 L	2007	-	2001
FORD	CONTOUR	V-6, 2.5 L	2000	-	1996

**38274**



FORD	SUPER DUTY VAN	V-10, 6.8 L	2002	-	2002
FORD	EXPLORER SPORT TRAC	V-8, 4.6 L	2007	-	2010
LINCOLN	MARK LT	V-8, 5.4 L	2007	-	2008
FORD	F-150	V-8, 4.6 L	2008	-	2010
FORD	EXPEDITION	V-8, 5.4 L	2004	-	2010
FORD	SUPER DUTY VAN	V-8, 5.4 L	2002	-	2002
FORD	F-250	V-8, 4.6 L	2007	-	2002
FORD	EXPEDITION	V-8, 4.6 L	2004	-	2002
FORD	F-550 SUPER DUTY	V-10, 6.8 L	2008	-	2010
FORD	SUPER DUTY VAN	V-8, 4.6 L	2003	-	2003
FORD	E SERIES VAN	V-8, 5.4 L	2007	-	2010
FORD	LOBO	V-8, 5.4 L	2007	-	2010
LINCOLN	AVIATOR	V-8, 4.6 L	2003	-	2005
FORD	MUSTANG	V-8, 4.6 L	2007	-	2010
FORD	E SERIES VAN	V-8, 4.6 L	2006	-	2010
FORD	EXPLORER	V-8, 4.6 L	2007	-	2010
FORD	F SERIES PICKUP	V-8, 5.4 L	2002	-	2002
FORD	SUPER DUTY PICKUP	V-10, 6.8 L	2003	-	2002
FORD	SUPER DUTY PICKUP	V-8, 5.4 L	2003	-	2002
FORD	EXCURSION	V-10, 6.8 L	2005	-	2002
FORD	F-450 SUPER DUTY	V-10, 6.8 L	2007	-	2010
FORD	LOBO	V-8, 4.6 L	2007	-	2010
FORD	F-350 SUPER DUTY	V-8, 5.4 L	2004	-	2010
LINCOLN	NAVIGATOR	V-8, 5.4 L	2007	-	2009

**38277**



DODGE	NEON	4 CIL, 2.0 L	2006	-	2004
-------	------	--------------	------	---	------

**38278**



ACURA	RDX	4 CIL, 2.3 L	2006	-	2010
HONDA	ACCORD	4 CIL, 2.4 L	2007	-	2003
HONDA	CR-V	4 CIL, 2.4 L	2006	-	2009
HONDA	ACCORD	4 CIL, 2.4 L	2004	-	2004

## Aplicación por Producto

**38279**



MERCURY	MARINER	V-6, 3.0 L	2007	-	2009
FORD	FIVE HUNDRED	V-6, 3.0 L	2007	-	2005
MERCURY	MILAN	V-6, 3.0 L	2007	-	2009
LINCOLN	LS	V-6, 3.0 L	2001	-	2000
JAGUAR	S-TYPE	V-8, 4.0 L	2002	-	2000
FORD	ESCAPE	V-6, 3.0 L	2007	-	2009
FORD	FUSION	V-6, 3.0 L	2008	-	2009
LINCOLN	LS	V-8, 3.9 L	2006	-	2000

**38284**



NISSAN	ALTIMA	4 CIL, 2.4 L	2004	-	2004
NISSAN	SENTRA	4 CIL, 2.5 L	2006	-	2003
NISSAN	ALTIMA	4 CIL, 2.5 L	2006	-	2003

**38285**



DODGE	RAM 4000	V-6, 5.9 L DIESEL	2007	-	2008
DODGE	RAM 4000	V-6, 6.7 L DIESEL	2008	-	2009

**38286**



TOYOTA	MATRIX	4 CIL, 1.8 L	2008	-	2003
--------	--------	--------------	------	---	------

TOYOTA	COROLLA	4 CIL, 1.8 L	2008	-	2002
--------	---------	--------------	------	---	------

**38289**



OLDSMOBILE	EIGHTY EIGHT	V-6, 3.8 L	1999	-	1999
------------	--------------	------------	------	---	------

**38291**



FORD	F-150	V-6, 4.2 L	2006	-	2003
------	-------	------------	------	---	------

**38297**



FORD	THUNDERBIRD	V-6, 3.8 L	1994	-	1994
------	-------------	------------	------	---	------

**38298**



FORD	THUNDERBIRD	V-6, 3.8 L	1994	-	1994
------	-------------	------------	------	---	------

**38299**



FORD	THUNDERBIRD	V-6, 3.8 L	1994	-	1994
------	-------------	------------	------	---	------

**38322**

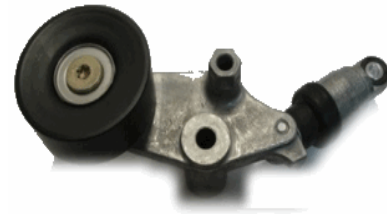

HONDA	ODYSSEY	V-6, 3.5 L	2004	-	2002
-------	---------	------------	------	---	------

**38314**



VOLKSWAGEN	BEETLE	5 CIL. 2.5 L	2009	-	2010
VOLKSWAGEN	BORA	5 CIL. 2.5 L	2005	-	2009
VOLKSWAGEN	BORA SPORTWAGEN	5 CIL. 2.5 L	2008	-	2009

**38323**

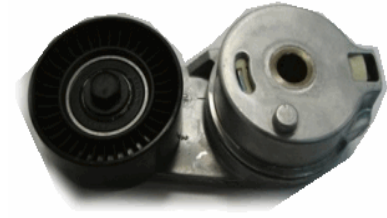

CHRYSLER	300 C	V-8, 5.7 L	2006	-	2009
DODGE	CHARGER	V-6, 3.5 L	2008	-	2009
DODGE	CHARGER	V-8, 5.7 L	2008	-	2009
DODGE	CHARGER	V-8, 6.1 L	2008	-	2009
DODGE	RAM 2500	V-8, 5.7 L	2009	-	2009
CHRYSLER	PACIFICA	V-6, 3.5 L	2006	-	2004
JEEP	GRAND CHEROKEE	V-8, 6.1 L	2007	-	2009
CHRYSLER	300 C	V-6, 3.5 L	2006	-	2009
CHRYSLER	300 C	V-8, 6.1 L	2006	-	2005
JEEP	COMMANDER	V-8, 5.7 L	2008	-	2009
DODGE	JOURNEY	4 CIL, 2.4 L	2009	-	2010
DODGE	DURANGO	V-8, 5.7 L	2008	-	2009
VOLKSWAGEN	ROUTAN	V-6, 3.8 L	2009	-	2010
JEEP	GRAND CHEROKEE	V-8, 5.7 L	2007	-	2009

**38315**

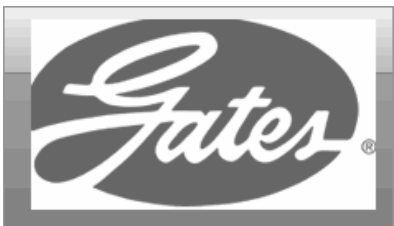

VOLKSWAGEN	BORA SPORTWAGEN	5 CIL. 2.5 L	2008	-	2009
VOLKSWAGEN	BEETLE	5 CIL. 2.5 L	2009	-	2010
VOLKSWAGEN	BORA	5 CIL. 2.5 L	2005	-	2009

**38327**



**38317**



VOLKSWAGEN	TOUAREG	V-6, 3.6 L	2007	-	2008
VOLKSWAGEN	TOUAREG	V-6, 3.2 L	2006	-	2006
AUDI	Q7	V-6, 3.6 L	2007	-	2009

HONDA	ODYSSEY	V-6, 3.5 L	2001	-	2001
HONDA	PILOT	V-6, 3.5 L	2004	-	2003



## Aplicación por Producto

**38328**



PONTIAC	G8	V-8, 6.0 L	2009 - 2009
CHEVROLET	CORVETTE	V-8, 6.0 L	2007 - 2005

**38329**

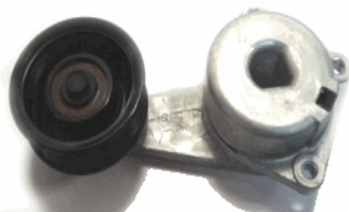

FORD	SUPER DUTY VAN	V-8, 4.6 L	2003 - 2003
FORD	SUPER DUTY VAN	V-8, 5.4 L	2002 - 2002
FORD	E SERIES VAN	V-8, 5.4 L	2007 - 2010
FORD	E SERIES VAN	V-8, 4.6 L	2006 - 2010
LINCOLN	MARK LT	V-8, 5.4 L	2007 - 2008
FORD	F SERIES PICKUP	V-8, 5.4 L	2002 - 2002
FORD	F-250	V-8, 4.6 L	2007 - 2002
FORD	F-150	V-8, 4.6 L	2008 - 2008
FORD	F-550 SUPER DUTY	V-10, 6.8 L	2008 - 2010
FORD	LOBO	V-8, 4.6 L	2007 - 2008
FORD	F-350 SUPER DUTY	V-8, 5.4 L	2007 - 2010
FORD	F-450 SUPER DUTY	V-10, 6.8 L	2007 - 2010
FORD	LOBO	V-8, 5.4 L	2007 - 2008
FORD	SUPER DUTY PICKUP	V-10, 6.8 L	2003 - 2002
FORD	SUPER DUTY PICKUP	V-8, 5.4 L	2003 - 2002
FORD	SUPER DUTY VAN	V-10, 6.8 L	2002 - 2002

**38330**



FORD	SUPER DUTY PICKUP	V-10, 6.8 L	2000 - 1999
FORD	E SERIES VAN	V-10, 6.8 L	1998 - 1997
FORD	F-250	V-8, 4.6 L	2001 - 1998
FORD	SUPER DUTY PICKUP	V-8, 5.4 L	2001 - 1999
FORD	SUPER DUTY VAN	V-8, 5.4 L	2001 - 1999
FORD	F SERIES PICKUP	V-8, 4.6 L	2001 - 1998

FORD	E SERIES VAN	V-8, 5.4 L	2001 - 1997
FORD	F SERIES PICKUP	V-8, 5.4 L	2001 - 1999
FORD	F-350 SUPER DUTY	V-8, 5.4 L	2006 - 2002
FORD	SUPER DUTY VAN	V-10, 6.8 L	2001 - 1999
FORD	E SERIES VAN	V-8, 4.6 L	2001 - 1999

**38332**



ACURA	RL	V-6, 3.7 L	2009 - 2010
ACURA	TL	V-6, 3.5 L	2008 - 2008
ACURA	TL	V-6, 3.2 L	2008 - 2006
ACURA	MDX	V-6, 3.5 L	2006 - 2006
HONDA	ODYSSEY	V-6, 3.5 L	2007 - 2010
HONDA	ACCORD	V-6, 3.0 L	2007 - 2003
ACURA	RL	V-6, 3.5 L	2008 - 2006
ACURA	MDX	V-6, 3.7 L	2008 - 2007
HONDA	RIDGELINE	V-6, 3.5 L	2007 - 2010
HONDA	PILOT	V-6, 3.5 L	2007 - 2008

**38339**



FORD	FUSION	4 CIL, 2.3 L	2007 - 2009
------	--------	--------------	-------------

**38340**



NISSAN	ARMADA	V-8, 5.6 L	2006 - 2010
NISSAN	TITAN	V-8, 5.6 L	2008 - 2009



**38350**



DODGE	VIPER	V-10, 8.0 L	2002 - 1998
-------	-------	-------------	-------------

**38357**



MAZDA	MAZDA 3	4 CIL, 2.0 L	2008 - 2006
MAZDA	MAZDA 5	4 CIL, 2.3 L	2007 - 2006
MAZDA	MAZDA 3	4 CIL, 2.3 L	2008 - 2006

**38376**



CHEVROLET	AVEO	4 CIL, 1.6 L	2009 - 2009
SUZUKI	SWIFT	4 CIL, 1.6 L	2008 - 2007
CHEVROLET	AVEO	4 CIL, 1.6 L	2008 - 2008
PONTIAC	G3	4 CIL, 1.6 L	2008 - 2006

**38378**



NISSAN	FRONTIER	V-6, 4.0 L	2007 - 2006
NISSAN	FRONTIER	V6, 4.0 L	2008 - 2008
NISSAN	PATHFINDER	V-6, 4.0 L	2007 - 2010
NISSAN	XTERRA	V-6, 4.0 L	2007 - 2006

**38382**



DODGE	RAM 3500	V-8, 5.7 L	2007 - 2003
DODGE	DURANGO	V-8, 5.7 L	2007 - 2006
CHRYSLER	ASPEN	V-8, 5.7 L	2007 - 2009
DODGE	RAM 2500	V-8, 5.7 L	2008 - 2008

**38384**



BMW	325I	V-6, 3.0 L	2006 - 2006
BMW	X3	6 CIL, 3.0 L	2006 - 2005
BMW	X5	6 CIL, 3.0 L	2006 - 2005
BMW	325I	V-6, 2.5 L	2005 - 2005
BMW	325CI	V-6, 2.5 L	2006 - 2006
BMW	325XI	V-6, 3.0 L	2006 - 2006

**38385**



FORD	MUSTANG SHELBY	V-8, 5.4 L	2009 - 2010
------	----------------	------------	-------------

**38397**



GMC	ACADIA	V-6, 3.6 L	2008 - 2010
PONTIAC	G8	V-6, 3.6 L	2009 - 2009
SUZUKI	XL-7	V-6, 3.6 L	2008 - 2009

## Aplicación por Producto

PONTIAC	G6	V-6, 3.6 L	2008	-	2007
BUICK	LACROSSE	V-6, 3.6 L	2010	-	2010
SUZUKI	GRAND VITARA	V-6, 3.2 L	2009	-	2010
BUICK	ENCLAVE	V-6, 3.6 L	2010	-	2010
SAAB	9 - 3	V-6, 2.8 L	2007	-	2006
CHEVROLET	TRAVERSE	V-6, 3.6 L	2010	-	2011
CHEVROLET	CAPTIVA	V-6, 3.6 L	2008	-	2010
CHEVROLET	MALIBU	V-6, 3.6 L	2008	-	2010

**38404**



MINI	COOPER	4 CIL, 1.6 L	2005	-	2008
------	--------	--------------	------	---	------

**38405**



MINI	COOPER	4 CIL, 1.6 L	2005	-	2007
------	--------	--------------	------	---	------

**38406**



AUDI	A4	V-6, 3.0 L	2006	-	2006
------	----	------------	------	---	------

**38408**



MAZDA	MAZDA 6	4 CIL, 2.3 L	2007	-	2006
FORD	ESCAPE	4 CIL, 2.3 L	2007	-	2005

MAZDA	MAZDA 3	4 CIL, 2.3 L	2008	-	2006
MERCURY	MARINER	4 CIL, 2.3 L	2007	-	2005

**38409**



MAZDA	MAZDA 6	4 CIL, 2.3 L	2007	-	2008
MAZDA	MAZDA 3	4 CIL, 2.3 L	2010	-	2010

**38410**



TOYOTA	RAV 4	V-6, 3.5 L	2008	-	2010
TOYOTA	HIGHLANDER	V-6, 3.5 L	2008	-	2010
TOYOTA	CAMRY	V-6, 3.5 L	2009	-	2011
TOYOTA	SIENNA	V-6, 3.5 L	2011	-	2010

**38411**



TOYOTA	FJ CRUISER	V-6, 4.0 L	2008	-	2007
TOYOTA	TACOMA	V-6, 4.0 L	2009	-	2010

**38413**



MINI	COOPER	4 CIL, 1.6 L	2005	-	2008
------	--------	--------------	------	---	------

**38415**

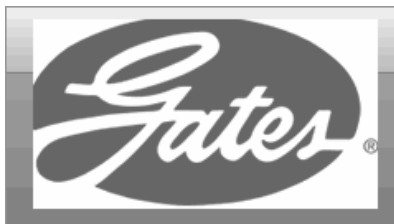

MERCEDES BE	VITO	4 CIL, 2.2 L	2008	-	2010
MERCEDES BE	SPRINTER	4 CIL, 2.2 L CDI	2008	-	2010

**38419**



CADILLAC	CTS	V-6, 3.6 L	2007	-	2007
----------	-----	------------	------	---	------

**38416**



FORD	MUSTANG	V-6, 4.0 L	2008	-	2010
------	---------	------------	------	---	------

**38420**



CHEVROLET	UPLANDER	V-6, 3.5 L	2007	-	2007
PONTIAC	MONTANA	V-6, 3.9 L	2008	-	2006
CHEVROLET	MALIBU	V-6, 3.5 L	2007	-	2007
CHEVROLET	UPLANDER	V-6, 3.9 L	2007	-	2009
PONTIAC	G6	V-6, 3.5 L	2008	-	2007

**38417**



CHRYSLER	PACIFICA	V-6, 4.0 L	2008	-	2007
DODGE	JOURNEY	V-6, 3.5 L	2009	-	2010
CHRYSLER	TOWN & COUNTRY	V6, 4.0 L	2008	-	2010

**38423**



AUDI	A6	V-6, 3.2 L	2006	-	2008
AUDI	Q5	V-6, 3.2 L	2009	-	2009
AUDI	A4	V-6, 3.2 L	2006	-	2009

**38418**



CADILLAC	CTS	V-6, 3.6 L	2007	-	2007
----------	-----	------------	------	---	------

**38450**



AUDI	A3	V-6, 3.2 L	2007	-	2008
------	----	------------	------	---	------

**38451**



AUDI	A8	V8, 4.2 L	2007	-	2007
------	----	-----------	------	---	------

**39051**



FORD	F-550 SUPER DUTY	V-8, 6.4 L DIESEL	2008	-	2010
FORD	F-450 SUPER DUTY	V-8, 6.4 L DIESEL	2008	-	2010
FORD	F-250 SUPER DUTY	V-8, 6.4 L DIESEL	2008	-	2010

**38452**



FORD	ESCAPE	4 CIL, 2.3 L	2008	-	2008
FORD	FUSION	4 CIL, 2.3 L	2007	-	2009
FORD	FUSION	4 CIL, 2.5 L	2010	-	2010
FORD	FOCUS	4 CIL, 2.0 L	2007	-	2010
FORD	ESCAPE	4 CIL, 2.5 L	2009	-	2010
MERCURY	MILAN	4 CIL, 2.5 L	2010	-	2010

**39052**



FORD	F-450 SUPER DUTY	V-8, 6.4 L DIESEL	2008	-	2010
FORD	F-550 SUPER DUTY	V-8, 6.4 L DIESEL	2008	-	2010
FORD	F-250 SUPER DUTY	V-8, 6.4 L DIESEL	2008	-	2010

**38453**



TOYOTA	MATRIX	4 CIL, 2.4 L	2009	-	2010
TOYOTA	CAMRY	4 CIL, 2.4 L	2007	-	2009
TOYOTA	COROLLA	4 CIL, 2.4 L	2009	-	2010

**39053**



DODGE	AVENGER	4 CIL, 2.0 L	2007	-	2009
DODGE	AVENGER	4 CIL, 2.4 L	2007	-	2009
DODGE	CALIBER	4 CIL, 2.4 L	2007	-	2009
JEEP	PATRIOT	4 CIL, 2.4 L	2009	-	2008
JEEP	COMPASS	4 CIL, 2.4 L	2009	-	2008

**38462**



PONTIAC	G8	V8, 6.0 L	2009	-	2009
---------	----	-----------	------	---	------

**39070**



HONDA	CIVIC HIBRIDO	4 CIL, 1.3 L	2005	-	2010
-------	---------------	--------------	------	---	------

### 39073

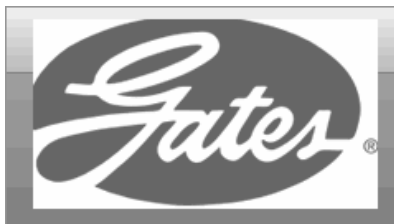

HONDA	ACCORD	4 CIL, 2.4 L	2008 - 2010
ACURA	TSX	4 CIL, 2.4 L	2009 - 2009

### 39077



HONDA	CIVIC	4 CIL, 1.8 L	2008 - 2010
-------	-------	--------------	-------------

### 39083



CHEVROLET	EXPRESS	V-8, 5.3 L	2009 - 2010
CADILLAC	ESCALADE	V-8 6.2 L	2009 - 2010
GMC	SIERRA	V-8, 6.2 L	2009 - 2010
CHEVROLET	EXPRESS	V-8, 6.0 L	2009 - 2010
GMC	SIERRA	V-8, 5.3 L	2009 - 2010
CHEVROLET	SILVERADO	V-8, 5.3 L	2009 - 2010
CHEVROLET	AVALANCHE	V-8, 5.3 L	2009 - 2010
CHEVROLET	SILVERADO	V-8, 4.8 L	2009 - 2010
GMC	YUKON	V-8, 6.2 L	2009 - 2010
CHEVROLET	SUBURBAN	V-8, 5.3 L	2009 - 2010
CHEVROLET	TAHOE	V-8, 5.3 L	2009 - 2010
CHEVROLET	SUBURBAN	V-8, 6.0 L	2009 - 2010
HUMMER	H2	V-8, 6.2 L	2009 - 2010

### 39092



HONDA	ACCORD	V-6, 3.5 L	2008 - 2010
HONDA	PILOT	V-6, 3.5 L	2009 - 2010
HONDA	ODYSSEY	V-6, 3.5 L	2008 - 2010

### 91030



FIAT	DUCATO	4 CIL, 2.3 L DIESE	2008 - 2010
MAZDA	MAZDA 6	V-6, 3.0 L	2008 - 2008
MAZDA	MAZDA 3	4 CIL, 2.3 L	2006 - 2009
MAZDA	MAZDA 3	4 CIL, 2.0 L	2006 - 2008
LINCOLN	MKZ	V-6, 3.5 L	2007 - 2009
FIAT	DUCATO	4 CIL, 3.0 L DIESE	2008 - 2010
HUMMER	H2	V-8, 6.2 L	2009 - 2010
GMC	SIERRA	V-8, 5.3 L	2009 - 2010
LINCOLN	MKX	V-6, 3.5 L	2007 - 2009
GMC	SIERRA	V-8, 6.2 L	2009 - 2010
FORD	TRANSIT	4 CIL, 2.2 L	2009 - 2008
CHEVROLET	EXPRESS	V-8, 6.0 L	2009 - 2010
DODGE	NITRO	V-6, 4.0 L	2009 - 2010
GMC	YUKON	V-8, 6.2 L	2009 - 2010
CHEVROLET	EXPRESS	V-8, 5.3 L	2009 - 2010
CHEVROLET	SUBURBAN	V-8, 6.0 L	2009 - 2010
CHEVROLET	AVALANCHE	V-8, 5.3 L	2009 - 2010
CHEVROLET	SILVERADO	V-8, 5.3 L	2009 - 2010
FORD	FUSION	V-6, 3.5 L	2010 - 2010
MERCURY	MARINER	V-6, 3.0 L	2007 - 2009
MERCURY	MILAN	V-6, 3.0 L	2007 - 2009
FORD	EDGE	V-6, 3.5 L	2007 - 2010
FORD	FIESTA	4 CIL, 1.6 L	2011 - 2011
FORD	ESCAPE	V-6, 3.0 L	2005 - 2009
MAZDA	CX-9	V-6, 3.7 L	2007 - 2008
CADILLAC	ESCALADE	V-8 6.2 L	2009 - 2010
CHEVROLET	TAHOE	V-8, 5.3 L	2009 - 2010
FORD	FUSION	V-6, 3.0 L	2007 - 2009
CHEVROLET	SUBURBAN	V-8, 5.3 L	2009 - 2010
CHEVROLET	SILVERADO	V-8, 4.8 L	2009 - 2010

### T36038



CHEVROLET	MONZA	4 CIL, 1.6 L	2004	-	1994
CHEVROLET	CHEVY SWING	4 CIL, 1.6 L	2003	-	1994
CHEVROLET	CHEVY POP	4 CIL, 1.6 L	2003	-	1994
CHEVROLET	CHEVY JOY	4 CIL, 1.6 L	2003	-	1994
CHEVROLET	CHEVY	4 CIL, 1.6 L	2009	-	2010
CHEVROLET	CHEVY C2 SEDAN	4 CIL, 1.6 L	2008	-	2004
CHEVROLET	CHEVY PICK-UP	4 CIL, 1.6 L	2006	-	2002
CHEVROLET	CHEVY C2	4 CIL, 1.6 L	2008	-	2004

### T36109



PEUGEOT	307	4 CIL, 2.0 L	2005	-	2009
---------	-----	--------------	------	---	------

### T36124



FORD	TRANSIT	4 CIL, 2.2 L	2009	-	2008
------	---------	--------------	------	---	------

### T38313



PEUGEOT	207	4 CIL, 1.6 L	2008	-	2009
---------	-----	--------------	------	---	------

### T38320



PEUGEOT	307	4 CIL, 2.0 L	2005	-	2009
---------	-----	--------------	------	---	------

### T38368



FIAT	BRAVO	4 CIL, 1.4 L	2009	-	2010
FIAT	GRANDE PUNTO	4 CIL, 1.4 L	2009	-	2010

### T38415



MERCEDES BE	SPRINTER	4 CIL, 2.2 L CDI	2007	-	2006
MERCEDES BE	SPRINTER	5 CIL, 2.7 L CDI	2005	-	2003

### T38428



RENAULT	SCENIC	4 CIL, 2.0 L	2004	-	2009
RENAULT	MEGANE	4 CIL, 2.0 L	2004	-	2009



### T38433

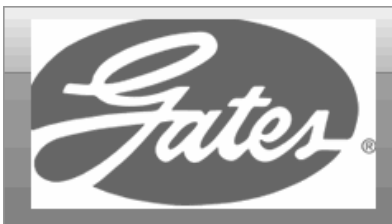

CHEVROLET	CRUZE	4 CIL, 1.8 L	2010	-	2011
-----------	-------	--------------	------	---	------

### T38456



RENAULT	KANGOO	4 CIL, 1.6 L	2009	-	2008
NISSAN	PLATINA	4 CIL, 1.6 L	2002	-	2010
RENAULT	KANGOO EXPRESS	4 CIL, 1.6 L	2009	-	2008
RENAULT	CLIO	4 CIL, 1.6 L	2009	-	2008
NISSAN	APRIO	4 CIL, 1.6 L	2008	-	2010

### T38484



RENAULT	KANGOO	4 CIL, 1.6 L	2009	-	2008
NISSAN	APRIO	4 CIL, 1.6 L	2008	-	2010
RENAULT	CLIO	4 CIL, 1.6 L	2009	-	2008
NISSAN	PLATINA	4 CIL, 1.6 L	2002	-	2010
RENAULT	KANGOO EXPRESS	4 CIL, 1.6 L	2009	-	2008

### T39074



MAZDA	CX-7	4 CIL, 2.3 L	2006	-	2008
-------	------	--------------	------	---	------

### T41001



DODGE	SHADOW	4 CIL, 2.5 L	1994	-	1994
DODGE	CARAVAN	4 CIL, 2.5 L	1995	-	1995
DODGE	SPIRIT	4 CIL, 2.5 L	1994	-	1994
DODGE	SHADOW	4 CIL, 2.2 L	1994	-	1994
CHRYSLER	LEBARON	4 CIL, 2.5 L	1994	-	1993

### T41002



DODGE	INTREPID	V-6, 3.5 L	1997	-	1995
CHRYSLER	CONCORDE	V-6, 3.5 L	1997	-	1995
DODGE	NEON	4 CIL, 2.0 L	2002	-	1995
CHRYSLER	CIRRUS	4 CIL, 2.0 L	2000	-	2000
CHRYSLER	NEW YORKER	V-6, 3.5 L	1996	-	1995
DODGE	STRATUS	4 CIL, 2.0 L	2000	-	1995

### T41005



FORD	RANGER	4 CIL, 2.3 L	2001	-	1995
FORD	RANGER	4 CIL, 2.5 L	2001	-	1998

### T41007



FORD	ESCORT	4 CIL, 1.9 L	1996	-	1994
------	--------	--------------	------	---	------

### T41008



FORD	CONTOUR	4 CIL, 2.0 L	1997	-	1995
MERCURY	MYSTIQUE	4 CIL, 2.0 L	1997	-	1995

### T41013



HONDA	ACCORD	4 CIL, 2.3 L	2002	-	1998
-------	--------	--------------	------	---	------

### T41014



HONDA	ACCORD	4 CIL, 2.3 L	2002	-	1998
-------	--------	--------------	------	---	------

### T41016



HONDA	CR-V	4 CIL, 2.0 L	2001	-	1999
HONDA	CIVIC	4 CIL, 1.6 L	2000	-	1999

### T41023



HONDA	CIVIC	4 CIL, 1.6 L	2000	-	1997
-------	-------	--------------	------	---	------

### T41031



FORD	ESCORT	4 CIL, 1.8 L	1996	-	1994
------	--------	--------------	------	---	------

### T41037



HYUNDAI	ATTITUDE	4 CIL, 1.6 L	2007	-	2006
HYUNDAI	ATTITUDE	4 CIL, 1.6 L	2008	-	2010
HYUNDAI	VERNA	4 CIL, 1.5 L	2006	-	2004
HYUNDAI	ATTITUDE	4 CIL, 1.4 L	2008	-	2010
HYUNDAI	VERNA	4 CIL, 1.6 L	2006	-	2005

### T41038



MINI	COOPER	4 CIL, 2.0 L	2007	-	2004
MITSUBISHI	GALANT	4 CIL, 2.4 L	2007	-	2004
MITSUBISHI	LANCER	4 CIL, 2.4 L	2005	-	2004
MITSUBISHI	LANCER	4 CIL, 2.0 L	2006	-	2004
MITSUBISHI	OUTLANDER	4 CIL, 2.4 L	2006	-	2004
DODGE	STRATUS	4 CIL, 2.4 L	2004	-	2001
CHRYSLER	SEBRING	4 CIL, 2.4 L	2004	-	2001

### T41039



CHRYSLER	SEBRING	V-6, 3.0 L	2005	-	2001
CHRYSLER	SEBRING	V-6, 2.5 L	2000	-	1996
DODGE	STRATUS	V-6, 3.0 L	2003	-	2001
MITSUBISHI	MONTERO	V-6, 3.8 L	2007	-	2004
MITSUBISHI	GALANT	V-6, 3.8 L	2005	-	2004
CHRYSLER	CIRRUS	V-6, 2.5 L	2000	-	1995
MITSUBISHI	ECLIPSE	V-6, 3.0 L	2005	-	2004
MITSUBISHI	MONTERO SPORT	V-6, 3.5 L	2004	-	2004
DODGE	STRATUS	V-6, 2.5 L	2000	-	1995
MITSUBISHI	ENDEAVOR	V-6, 3.8 L	2007	-	2004
MITSUBISHI	ECLIPSE	V-6, 3.8 L	2007	-	2008

### T41054



DODGE	STRATUS	4 CIL, 2.4 L	2004	-	2001
CHRYSLER	SEBRING	4 CIL, 2.4 L	2004	-	2001

### T41059



NISSAN	MAXIMA	V-6, 3.0 L	1994	-	1993
NISSAN	FRONTIER	V-6, 3.3 L	2004	-	1999
NISSAN	PATHFINDER	V-6, 3.0 L	1995	-	1995
NISSAN	PATHFINDER	V-6, 3.3 L	2000	-	1997
NISSAN	QUEST	V-6, 3.0 L	1998	-	1997
NISSAN	QUEST	V-6, 3.3 L	2001	-	1999
NISSAN	XTERRA	V-6, 3.3 L	2002	-	2000

### T41044



HYUNDAI	H100	4 CIL, 2.4 L	2005	-	2003
---------	------	--------------	------	---	------

### T41065



CHEVROLET	TRACKER	4 CIL, 1.6 L	2000	-	1998
-----------	---------	--------------	------	---	------

### T41048



CHRYSLER	VOYAGER	V-6, 3.0 L	2000	-	2000
DODGE	CARAVAN	V-6, 3.0 L	1995	-	1995
DODGE	SPIRIT	V-6, 3.0 L	1994	-	1994
CHRYSLER	LEBARON	V-6, 3.0 L	1995	-	1993

### T41067



TOYOTA	CAMRY	4 CIL, 2.2 L	2001	-	2001
--------	-------	--------------	------	---	------

## Aplicación por Producto

### T41075



CHRYSLER	CONCORDE	V-6, 3.5 L	2002 - 1993
CHRYSLER	300M	V-6, 3.5 L	2002 - 1999
DODGE	INTREPID	V-6, 3.5 L	2002 - 2000
DODGE	INTREPID	V-6, 3.2 L	2000 - 1998

### T41085



TOYOTA	CAMRY	V-6, 3.0 L	2001 - 2001
TOYOTA	SIENNA	V-6, 3.0 L	2003 - 2000

### T41078



NISSAN	300ZX	V-6, 3.0 L	1996 - 1993
--------	-------	------------	-------------

### T41086



TOYOTA	4 RUNNER	V-8, 4.7 L	2007 - 2003
TOYOTA	SEQUOIA	V-8, 4.7 L	2008 - 2007
TOYOTA	TUNDRA	V-8, 4.7 L	2008 - 2007
TOYOTA	LAND CRUISER	V-8, 4.7 L	2006 - 2003

AUDI	A4	V-6, 3.0 L	2006 - 2006
------	----	------------	-------------

### T41079



### T41090



VOLKSWAGEN	POINTER	4 CIL, 1.8 L	2008 - 1998
VOLKSWAGEN	PASSAT	4 CIL, 2.0 L	1996 - 1995
VOLKSWAGEN	GOLF	4 CIL, 2.0 L	2000 - 1995
VOLKSWAGEN	CABRIO	4 CIL, 2.0 L	2002 - 1995
VOLKSWAGEN	DERBY	4 CIL, 1.8 L	2008 - 2005
VOLKSWAGEN	JETTA	4 CIL, 2.0 L	2000 - 1995

HONDA	ACCORD	V-6, 3.0 L	2001 - 1998
-------	--------	------------	-------------

### T41098



### T41084



VOLKSWAGEN	TOUAREG	V-8, 4.2 L	2006 - 2006
------------	---------	------------	-------------

CHRYSLER	CONCORDE	V-6, 3.2 L	2000 - 1998
CHRYSLER	NEW YORKER	V-6, 3.5 L	1994 - 1994

**T41204**



TOYOTA	4 RUNNER	V-6, 3.4 L	2002	-	2002
--------	----------	------------	------	---	------

**T41230**



VOLKSWAGEN	TOUAREG	V-8, 4.2 L	2006	-	2006
------------	---------	------------	------	---	------

**T41212**



MITSUBISHI	LANCER	4 CIL, 2.0 L	2005	-	2008
------------	--------	--------------	------	---	------

**T41231**



ACURA	RL	V-6, 3.7 L	2009	-	2010
ACURA	RL	V-6, 3.5 L	2006	-	2008
HONDA	ODYSSEY	V-6, 3.5 L	2008	-	2010
ACURA	TL	V-6, 3.2 L	2006	-	2008
HONDA	ACCORD	V-6, 3.5 L	2008	-	2010
ACURA	TL	V-6, 3.5 L	2008	-	2010
ACURA	MDX	V-6, 3.7 L	2007	-	2010
ACURA	MDX	V-6, 3.5 L	2006	-	2006
ACURA	TL	V-6, 3.7 L	2009	-	2010
HONDA	PILOT	V-6, 3.5 L	2008	-	2010
HONDA	RIDGELINE	V-6, 3.5 L	2008	-	2010
ACURA	TSX	V-6, 3.5 L	2010	-	2010

**T41228**



VOLKSWAGEN	TOUAREG	V-8, 4.2 L	2006	-	2006
------------	---------	------------	------	---	------

**T41229**



VOLKSWAGEN	JETTA	4 CIL, 1.9 L DIESE	2007	-	2005
VOLKSWAGEN	EUROVAN	4 CIL, 1.9 L DIESE	2006	-	2009
VOLKSWAGEN	BORA	4 CIL, 2.0 L DIESE	2009	-	2010
VOLKSWAGEN	BORA	4 CIL, 1.9 L DIESE	2007	-	2007

**T41232**



ACURA	RL	V-6, 3.7 L	2009	-	2010
ACURA	RL	V-6, 3.5 L	2006	-	2008
HONDA	ACCORD	V-6, 3.0 L	2007	-	2005
HONDA	ACCORD	V-6, 3.5 L	2008	-	2010
ACURA	TSX	V-6, 3.5 L	2010	-	2010
ACURA	TL	V-6, 3.2 L	2006	-	2008
HONDA	PILOT	V-6, 3.5 L	2007	-	2010
HONDA	RIDGELINE	V-6, 3.5 L	2007	-	2010
ACURA	TL	V-6, 3.7 L	2009	-	2010
HONDA	ODYSSEY	V-6, 3.5 L	2007	-	2010
ACURA	MDX	V-6, 3.7 L	2007	-	2010

## Aplicación por Producto

ACURA	MDX	V-6, 3.5 L	2006 - 2006
ACURA	TL	V-6, 3.5 L	2008 - 2010

HYUNDAI	ATOS	4 CIL, 1.1 L	2008 - 2005
HYUNDAI	ATOS	4 CIL, 1.0 L	2004 - 2000

**T41235**

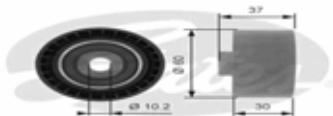

**T41267**



PEUGEOT	307	4 CIL, 2.0 L	2005 - 2009
---------	-----	--------------	-------------

PONTIAC	MATIZ G2	4 CIL, 1.0 L	2003 - 2009
---------	----------	--------------	-------------

**T41237**



**T42005**



RENAULT	SANDERO	4 CIL, 1.6 L	2010 - 2010
NISSAN	APRIO	4 CIL, 1.6 L	2008 - 2010
RENAULT	STEPWAY	4 CIL, 1.6 L	2010 - 2010
NISSAN	PLATINA	4 CIL, 1.6 L	2002 - 2010
RENAULT	KANGOO	4 CIL, 1.6 L	2009 - 2008
RENAULT	EUROCLIO	4 CIL, 1.6 L	2007 - 2008
RENAULT	KANGOO EXPRESS	4 CIL, 1.6 L	2009 - 2008
RENAULT	CLIO	4 CIL, 1.6 L	2009 - 2008

FORD	ESCORT	4 CIL, 1.8 L	1996 - 1994
------	--------	--------------	-------------

**T42016**



**T41240**

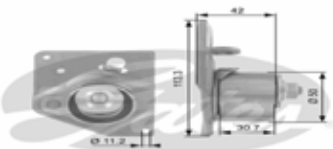

HYUNDAI	ATTITUDE	4 CIL, 1.6 L	2006 - 2007
HYUNDAI	ATTITUDE	4 CIL, 1.4 L	2008 - 2010
HYUNDAI	ATTITUDE	4 CIL, 1.6 L	2008 - 2010

RENAULT	TRAFIC	4 CIL, 1.9 L DIESE2008	- 2010
---------	--------	------------------------	--------

**T42017**



**T41241**



DODGE	STRATUS	4 CIL, 2.4 L	2004 - 2001
CHRYSLER	SEBRING	4 CIL, 2.4 L	2004 - 2001
MITSUBISHI	LANCER	4 CIL, 2.0 L	2005 - 2004

HYUNDAI	ATOS	4 CIL, 1.1 L	2008 - 2010
---------	------	--------------	-------------



### T42018



CHRYSLER	SEBRING	V-6, 3.0 L	2005	-	2001
CHRYSLER	CIRRUS	V-6, 2.5 L	2000	-	1995
CHRYSLER	SEBRING	V-6, 2.5 L	2000	-	1996
MITSUBISHI	ECLIPSE	V-6, 3.0 L	2005	-	2004
DODGE	STRATUS	V-6, 3.0 L	2003	-	2001
MITSUBISHI	GALANT	V-6, 3.8 L	2005	-	2004
MITSUBISHI	MONTERO SPORT	V-6, 3.5 L	2004	-	2004
MITSUBISHI	MONTERO	V-6, 3.8 L	2007	-	2004
DODGE	STRATUS	V-6, 2.5 L	2000	-	1995
MITSUBISHI	ENDEAVOR	V-6, 3.8 L	2007	-	2004
MITSUBISHI	ECLIPSE	V-6, 3.8 L	2007	-	2008

### T42019



SEAT	ALTEA	4 CIL, 2.0 L	2008	-	2006
AUDI	A4	4 CIL, 1.8 L	2006	-	2006
SEAT	LEON	4 CIL, 2.0 L	2007	-	2006
AUDI	A3	4 CIL, 2.0 L	2006	-	2008
VOLKSWAGEN	GLI	4 CIL, 2.0 L TURB2008	-	-	2007
VOLKSWAGEN	GTI	4 CIL, 2.0 L TURB2008	-	-	2007
SEAT	TOLEDO	4 CIL, 2.0 L	2007	-	2006

### T42020



NISSAN	300ZX	V-6, 3.0 L	1996	-	1993
--------	-------	------------	------	---	------

### T42021



NISSAN	300ZX	V-6, 3.0 L	1996	-	1993
--------	-------	------------	------	---	------

### T42023



SUBARU	IMPREZA	4 CIL, 2.5 L	2006	-	2006
SUBARU	OUTBACK	4 CIL, 2.5 L	2006	-	2006
SUBARU	LEGACY	4 CIL, 2.5 L	2006	-	2006
SUBARU	FORESTER	4 CIL, 2.5 L	2006	-	2006

### T42024



SUBARU	OUTBACK	4 CIL, 2.5 L	2006	-	2006
SUBARU	FORESTER	4 CIL, 2.5 L	2006	-	2006
SUBARU	LEGACY	4 CIL, 2.5 L	2006	-	2006
SUBARU	IMPREZA	4 CIL, 2.5 L	2006	-	2006

### T42025



TOYOTA	CAMRY	4 CIL, 2.2 L	2001	-	2001
--------	-------	--------------	------	---	------

### T42030



TOYOTA	CAMRY	V-6, 3.0 L	2006	-	2001
TOYOTA	SIENNA	V-6, 3.0 L	2003	-	2000
TOYOTA	SOLARA	V-6, 3.3 L	2006	-	2005
TOYOTA	SIENNA	V-6, 3.3 L	2006	-	2004

### T42034



FORD	FOCUS	4 CIL, 2.0 L	2004	-	2000
FORD	CONTOUR	4 CIL, 2.0 L	2000	-	1998
MERCURY	MYSTIQUE	4 CIL, 2.0 L	2000	-	1998
FORD	ESCORT	4 CIL, 2.0 L	2002	-	1998
FORD	ESCAPE	4 CIL, 2.0 L	2002	-	2001
FORD	ZX2	4 CIL, 2.0 L	2003	-	2003

### T42031



TOYOTA	SEQUOIA	V-8, 4.7 L	2008	-	2007
TOYOTA	4 RUNNER	V-8, 4.7 L	2007	-	2003
TOYOTA	LAND CRUISER	V-8, 4.7 L	2006	-	2003
TOYOTA	TUNDRA	V-8, 4.7 L	2008	-	2007

### T42035



FORD	ESCORT	4 CIL, 2.0 L	1999	-	1998
FORD	CONTOUR	4 CIL, 2.0 L	1999	-	1998
MERCURY	MYSTIQUE	4 CIL, 2.0 L	1999	-	1998

### T42032



FORD	CONTOUR	4 CIL, 2.0 L	1997	-	1995
MERCURY	MYSTIQUE	4 CIL, 2.0 L	1997	-	1995

### T42036



FORD	ESCORT	4 CIL, 2.0 L	2002	-	1999
FORD	ESCAPE	4 CIL, 2.0 L	2002	-	2001
MERCURY	MYSTIQUE	4 CIL, 2.0 L	2000	-	1999
FORD	ZX2	4 CIL, 2.0 L	2003	-	2003
FORD	CONTOUR	4 CIL, 2.0 L	2000	-	1999
FORD	FOCUS	4 CIL, 2.0 L	2004	-	2000

### T42033



FORD	CONTOUR	4 CIL, 2.0 L	1997	-	1995
MERCURY	MYSTIQUE	4 CIL, 2.0 L	1997	-	1995

### T42038



HONDA	ACCORD	V-6, 3.0 L	2001	-	1998
-------	--------	------------	------	---	------

### T42044



VOLKSWAGEN	TOUAREG	V-6, 3.0 L DIESEL	2009	-	2010
------------	---------	-------------------	------	---	------

### T42061

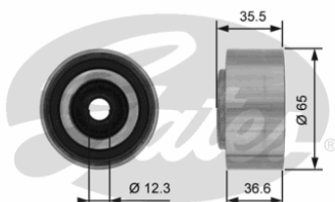

FIAT	PALIO ADVENTURE	4 CIL, 1.6 L	2006	-	2003
------	-----------------	--------------	------	---	------

FIAT	PALIO	4 CIL, 1.6 L	2006	-	2003
------	-------	--------------	------	---	------

### T42066

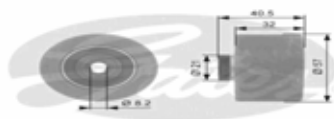

PEUGEOT	GRAND RAID	4 CIL, 1.6 L	2004	-	2008
---------	------------	--------------	------	---	------

PEUGEOT	PARTNER	4 CIL, 1.6 L	2004	-	2008
---------	---------	--------------	------	---	------

### T42097



VOLVO	C30	5 CIL, 2.4 L	2008	-	2010
-------	-----	--------------	------	---	------

VOLVO	C30	5 CIL, 2.5 L	2008	-	2010
-------	-----	--------------	------	---	------

VOLVO	S40	5 CIL, 2.4 L	2008	-	2005
-------	-----	--------------	------	---	------

VOLVO	S40	5 CIL, 2.5 L	2008	-	2007
-------	-----	--------------	------	---	------

VOLVO	XC90	5 CIL, 2.5 L	2003	-	2006
-------	------	--------------	------	---	------

### T42121



CHRYSLER	PT CRUISER	4 CIL, 2.4 L	2005	-	2010
----------	------------	--------------	------	---	------

CHRYSLER	CIRRUS	4 CIL, 2.4 L	2000	-	1995
----------	--------	--------------	------	---	------

CHRYSLER	SEBRING	4 CIL, 2.4 L	2005	-	1996
----------	---------	--------------	------	---	------

DODGE	CARAVAN	4 CIL, 2.4 L	2002	-	1997
-------	---------	--------------	------	---	------

DODGE	NEON	4 CIL, 2.4 L	2005	-	2003
-------	------	--------------	------	---	------

DODGE	STRATUS	4 CIL, 2.4 L	2006	-	1995
-------	---------	--------------	------	---	------

JEEP	WRANGLER	4 CIL, 2.4 L	2006	-	2003
------	----------	--------------	------	---	------

### T42129



HYUNDAI	H100 VAN/WAGON	4 CIL, 2.5 L DIESE	2009	-	2010
---------	----------------	--------------------	------	---	------

HYUNDAI	H100	4 CIL, 2.5 L DIESE	2009	-	2010
---------	------	--------------------	------	---	------

### T42137



## Aplicación por Producto

AUDI A4 V-6, 3.0 L 2006 - 2006

### T42170



CHEVROLET AVEO 4 CIL, 1.6 L 2008 - 2009  
SUZUKI SWIFT 4 CIL, 1.6 L 2008 - 2008

### T42191

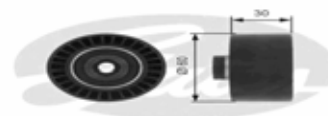

PEUGEOT 207 4 CIL, 1.6 L 2008 - 2009

### T43001



DODGE STRATUS 4 CIL, 2.0 L 2000 - 1996  
CHRYSLER CIRRUS 4 CIL, 2.0 L 2000 - 2000  
DODGE NEON 4 CIL, 2.0 L 2005 - 1996

### T43003



FORD ESCAPE 4 CIL, 2.0 L 2002 - 2001  
FORD CONTOUR 4 CIL, 2.0 L 2000 - 1998  
FORD FOCUS 4 CIL, 2.0 L 2004 - 2000  
MERCURY MYSTIQUE 4 CIL, 2.0 L 2000 - 1998  
FORD ESCORT 4 CIL, 2.0 L 2002 - 1998  
FORD ZX2 4 CIL, 2.0 L 2003 - 2003

### T42138



AUDI A4 V-6, 3.0 L 2006 - 2006

### T42163



FIAT DUCATO 4 CIL, 2.3 L DIESE2008 - 2010

### T42166

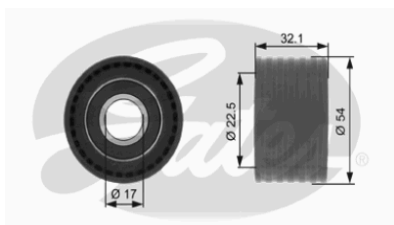

RENAULT SCENIC 4 CIL, 2.0 L 2009 - 2009  
RENAULT MEGANE 4 CIL, 2.0 L 2009 - 2009  
RENAULT MEGANE 4 CIL, 2.0 L 2008 - 2001  
RENAULT SCENIC 4 CIL, 2.0 L 2007 - 2001  
RENAULT CLIO 4 CIL, 2.0 L SPOR2006 - 2003

### T42167



RENAULT SCENIC 4 CIL, 2.0 L 2004 - 2009  
RENAULT MEGANE 4 CIL, 2.0 L 2004 - 2009

## Aplicación por Producto

### T43004



FORD	ESCORT	4 CIL, 2.0 L	2002 - 1997
FORD	FOCUS	4 CIL, 2.0 L	2004 - 2000

### T43005



DODGE	CARAVAN	4 CIL, 2.4 L	2002 - 1997
DODGE	STRATUS	4 CIL, 2.4 L	2002 - 1996
CHRYSLER	SEBRING	4 CIL, 2.4 L	2002 - 1996
CHRYSLER	PT CRUISER	4 CIL, 2.4 L	2002 - 2001
CHRYSLER	CIRRUS	4 CIL, 2.4 L	2000 - 1996

### T43008



JEEP	WRANGLER	4 CIL, 2.4 L	2006 - 2003
DODGE	STRATUS	4 CIL, 2.4 L	2006 - 1997
CHRYSLER	SEBRING	4 CIL, 2.4 L	2005 - 1997
DODGE	CARAVAN	4 CIL, 2.4 L	2002 - 1997
CHRYSLER	PT CRUISER	4 CIL, 2.4 L	2005 - 2010
DODGE	NEON	4 CIL, 2.4 L	2005 - 2003
CHRYSLER	CIRRUS	4 CIL, 2.4 L	2000 - 1997

### T43010



SEAT	CORDOBA	4 CIL, 2.0 L	2003 - 2007
VOLKSWAGEN	JETTA	4 CIL, 2.0 L	2005 - 1999
VOLKSWAGEN	GOLF	4 CIL, 2.0 L	2006 - 1999
VOLKSWAGEN	BEETLE	4 CIL, 2.0 L	2005 - 1998
SEAT	IBIZA	4 CIL, 2.0 L	2003 - 2009

### T43016



SEAT	AHLAMBRA	4 CIL, 1.8 L	2007 - 2003
VOLKSWAGEN	SHARAN	4 CIL, 1.8 L	2007 - 2003

### T43017



SEAT	TOLEDO	4 CIL, 1.8 L	2005 - 2003
SEAT	AHLAMBRA	4 CIL, 1.8 L	2007 - 2003
VOLKSWAGEN	SHARAN	4 CIL, 1.8 L	2007 - 2003
SEAT	LEON	4 CIL, 1.8 L	2005 - 2003

### T43018



AUDI	A4	4 CIL, 1.8 L	2006 - 2006
------	----	--------------	-------------

### T43022

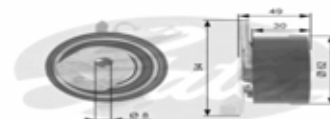

PEUGEOT	307	4 CIL, 2.0 L	2005 - 2009
---------	-----	--------------	-------------

## Aplicación por Producto

**T43023**



PONTIAC	G3	4 CIL, 1.6 L	2008	-	2006
CHEVROLET	AVEO	4 CIL, 1.6 L	2009	-	2009
SUZUKI	SWIFT	4 CIL, 1.6 L	2008	-	2008
CHEVROLET	AVEO	4 CIL, 1.6 L	2008	-	2008

**T43055**



PEUGEOT 206 ..... 4 CIL, 1.4 L ..... 2008 - 1998

**T43027**



FIAT	GRANDE PUNTO	4 CIL, 1.4 L	2009	-	2010
FIAT	BRAVO	4 CIL, 1.4 L	2009	-	2010

AUDI A4 ..... V-6, 3.0 L ..... 2006 - 2006

**T43064**



**T43028**



RENAULT	SANDERO	4 CIL, 1.6 L	2010	-	2010
NISSAN	PLATINA	4 CIL, 1.6 L	2008	-	2010
RENAULT	KANGOO	4 CIL, 1.6 L	2008	-	2010
NISSAN	APRIO	4 CIL, 1.6 L	2008	-	2010
RENAULT	STEPWAY	4 CIL, 1.6 L	2010	-	2010
RENAULT	CLIO	4 CIL, 1.6 L	2008	-	2009
RENAULT	KANGOO EXPRESS	4 CIL, 1.6 L	2008	-	2009
RENAULT	EUROCLIO	4 CIL, 1.6 L	2007	-	2008

AUDI A4 ..... 4 CIL, 1.8 L ..... 2006 - 2006

**T43032**



**T43067**



VOLKSWAGEN TOUAREG ..... V-8, 4.2 L ..... 2006 - 2006

AUDI A8 ..... V8, 4.2 L ..... 2007 - 2007

VOLKSWAGEN CRAFTER ..... 5 CIL, 2.5 L TDI ..... 2008 - 2010

**T43039**





### T43068

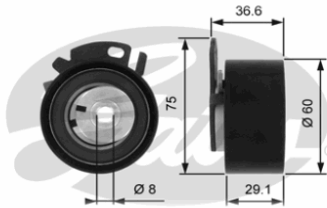

FIAT	PALIO	4 CIL, 1.6 L	2006 - 2003
FIAT	PALIO ADVENTURE	4 CIL, 1.6 L	2006 - 2003

### T43091



VOLKSWAGEN	EUROVAN	4 CIL, 1.9 L DIESE2005	- 2009
VOLKSWAGEN	JETTA	4 CIL, 1.9 L DIESE2007	- 2005
VOLKSWAGEN	BORA	4 CIL, 1.9 L DIESE2007	- 2007

### T43096



TOYOTA	CAMRY	V-6, 3.0 L	2001 - 2001
TOYOTA	SIENNA	V-6, 3.0 L	2003 - 2000

### T43097



TOYOTA	4 RUNNER	V-8, 4.7 L	2007 - 2003
TOYOTA	LAND CRUISER	V-8, 4.7 L	2006 - 2003

### T43098



TOYOTA	SIENNA	V-6, 3.3 L	2006 - 2004
TOYOTA	SOLARA	V-6, 3.3 L	2006 - 2005
TOYOTA	CAMRY	V-6, 3.0 L	2006 - 2002

### T43129



ACURA	MDX	V-6, 3.5 L	2006 - 2006
ACURA	RL	V-6, 3.5 L	2006 - 2008
ACURA	TL	V-6, 3.5 L	2008 - 2010
ACURA	TL	V-6, 3.7 L	2009 - 2010
ACURA	TSX	V-6, 3.5 L	2010 - 2010
ACURA	RL	V-6, 3.7 L	2009 - 2010
ACURA	TL	V-6, 3.2 L	2006 - 2008
HONDA	RIDGELINE	V-6, 3.5 L	2008 - 2010
HONDA	PILOT	V-6, 3.5 L	2008 - 2010
HONDA	ODYSSEY	V-6, 3.5 L	2008 - 2010
HONDA	ACCORD	V-6, 3.5 L	2008 - 2010
ACURA	MDX	V-6, 3.7 L	2007 - 2010

### T43131



CHRYSLER	PT CRUISER	4 CIL, 2.4 L	2008 - 2010
----------	------------	--------------	-------------



## Aplicación por Producto

DODGE	NITRO	V-6, 4.0 L	2009	-	2010
DODGE	CHARGER	V-6, 3.5 L	2009	-	2009
CHRYSLER	TOWN & COUNTRY	V6, 4.0 L	2008	-	2010
CHRYSLER	300 C	V-6, 3.5 L	2007	-	2009

### TMV-22001



VOLKSWAGEN	POINTER	4 CIL, 2.0 L	2006	-	1998
VOLKSWAGEN	POINTER PICK-UP	4 CIL, 1.8 L	2005	-	1998
VOLKSWAGEN	POINTER	4 CIL, 1.8 L	2008	-	1998
VOLKSWAGEN	PANEL	4 CIL, 1.8 L	2001	-	1998

### TMV-22002



VOLKSWAGEN	POINTER	4 CIL, 2.0 L	2006	-	1998
VOLKSWAGEN	POINTER PICK-UP	4 CIL, 1.8 L	2005	-	1998
VOLKSWAGEN	PANEL	4 CIL, 1.8 L	2001	-	1998
VOLKSWAGEN	POINTER	4 CIL, 1.8 L	2008	-	1998

### TMV-23001



SEAT	IBIZA	4 CIL, 1.6 L	2007	-	2009
VOLKSWAGEN	POLO	4 CIL, 1.6 L	2007	-	2003
VOLKSWAGEN	CROSSFOX	4 CIL, 1.6 L	2008	-	2006
VOLKSWAGEN	VW VAN	4 CIL, 1.6 L	2006	-	2003
VOLKSWAGEN	SPORTVAN	4 CIL, 1.6 L	2008	-	2006
SEAT	CORDOBA	4 CIL, 1.6 L	2007	-	2008
VOLKSWAGEN	LUPO	4 CIL, 1.6 L	2008	-	2004

### TMV13001



FORD	FIESTA	4 CIL, 1.6 L	2009	-	2008
FORD	IKON	4 CIL, 1.6 L	2007	-	2007
FORD	KA	4 CIL, 1.6 L	2007	-	2007

### TMV-13001



FORD	IKON	4 CIL, 1.6 L	2005	-	2000
FORD	KA	4 CIL, 1.6 L	2005	-	2001

### TMV-14001



CHEVROLET	CORSA	4 CIL, 1.4 L	2002	-	2003
FIAT	PALIO ADVENTURE	4 CIL, 1.8 L	2008	-	2006
FIAT	PALIO	4 CIL, 1.8 L	2008	-	2006
CHEVROLET	ASTRA	4 CIL, 1.8 L	2003	-	2000
CHEVROLET	CORSA	4 CIL, 1.8 L	2008	-	2003
CHEVROLET	MERIVA	4 CIL, 1.8 L	2008	-	2008
CHEVROLET	MERIVA	4 CIL, 1.8 L	2005	-	2007
CHEVROLET	ZAFIRA	4 CIL, 1.8 L	2003	-	2000
CHEVROLET	CORSA	4 CIL, 1.8 L	2009	-	2009
CHEVROLET	TORNADO	4 CIL, 1.8 L	2003	-	2009

## Aplicación por Producto

### TPG-14001



CHEVROLET	OPTRA	4 CIL. 2.0 L	2006 - 2010
CHEVROLET	ZAFIRA	4 CIL. 2.0 L	2006 - 2004
CHEVROLET	ASTRA	4 CIL. 2.0 L	2006 - 2004

### TPG-14002



CHEVROLET	ASTRA	4 CIL. 2.4 L	2006 - 2004
CHEVROLET	ZAFIRA	4 CIL. 2.4 L	2006 - 2004

### TPG-14003



CHEVROLET	CHEVY JOY	4 CIL. 1.6 L	2003 - 1994
CHEVROLET	CHEVY PICK-UP	4 CIL. 1.6 L	2006 - 2002
CHEVROLET	CHEVY POP	4 CIL. 1.6 L	2003 - 1994
CHEVROLET	CHEVY SWING	4 CIL. 1.6 L	2003 - 1994
CHEVROLET	CHEVY C2 SEDAN	4 CIL. 1.6 L	2008 - 2004
CHEVROLET	CHEVY C2	4 CIL. 1.6 L	2008 - 2004
CHEVROLET	CHEVY	4 CIL. 1.6 L	2009 - 2010
CHEVROLET	MONZA	4 CIL. 1.6 L	2004 - 1994

### TPG-14004



CHEVROLET	ASTRA	4 CIL. 1.8 L	2003 - 2000
-----------	-------	--------------	-------------

FIAT	PALIO ADVENTURE	4 CIL. 1.8 L	2008 - 2006
FIAT	PALIO	4 CIL. 1.8 L	2008 - 2006
CHEVROLET	TORNADO	4 CIL. 1.8 L	2007 - 2003
CHEVROLET	MERIVA	4 CIL. 1.8 L	2007 - 2005
CHEVROLET	CORSA	4 CIL. 1.4 L	2002 - 2002
CHEVROLET	CORSA	4 CIL. 1.8 L	2008 - 2003
CHEVROLET	CORSA	4 CIL. 1.4 L	2003 - 2003
CHEVROLET	CORSA	4 CIL. 1.8 L	2009 - 2009
CHEVROLET	MERIVA	4 CIL. 1.8 L	2008 - 2008
CHEVROLET	ZAFIRA	4 CIL. 1.8 L	2003 - 2000
CHEVROLET	TORNADO	4 CIL. 1.8 L	2008 - 2009

### TPG-20001



RENAULT	SCENIC	4 CIL. 2.0 L	2007 - 2001
RENAULT	CLIO	4 CIL. 2.0 L SPOR	2006 - 2003
RENAULT	LAGUNA	4 CIL. 2.0 L	2004 - 2001
RENAULT	MEGANE	4 CIL. 2.0 L	2009 - 2009
RENAULT	MEGANE	4 CIL. 2.0 L	2008 - 2001
RENAULT	SCENIC	4 CIL. 2.0 L	2009 - 2009

### TPG-22001



VOLKSWAGEN	EUROVAN	5 CIL. 2.5 L	2002 - 2003
------------	---------	--------------	-------------

### TPG-23001



SEAT	IBIZA	4 CIL. 1.6 L	2007 - 2009
VOLKSWAGEN	SAVEIRO	4 CIL. 1.6 L	2010 - 2010
VOLKSWAGEN	VW VAN	4 CIL. 1.6 L	2005 - 2003
VOLKSWAGEN	GOL	4 CIL. 1.6 L	2009 - 2010
VOLKSWAGEN	LUPO	4 CIL. 1.6 L	2008 - 2004



# Master Automotriz 2010



## Aplicación por Producto

VOLKSWAGEN	POLO	4 CIL, 1.6 L	2007	-	2003
SEAT	CORDOBA	4 CIL, 1.6 L	2007	-	2008

## Aplicación por Producto

### Termostatos

13346

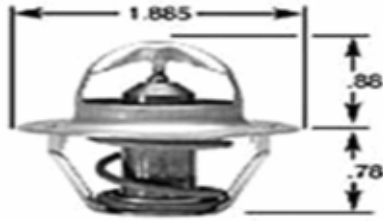

CHEVROLET	CHEVY C2	4 CIL, 1.6 L	2008	-	2004
CHEVROLET	CHEVY	4 CIL, 1.6 L	2009	-	2010
CHEVROLET	CHEVY PICK-UP	4 CIL, 1.6 L	2006	-	2002
CHEVROLET	CHEVY C2 SEDAN	4 CIL, 1.6 L	2007	-	2004

14289



DODGE	RAM 4000	V-6, 5.9 L DIESEL	2007	-	2003
-------	----------	-------------------	------	---	------

14778



NISSAN	MURANO	6 CIL, 3.5 L	2006	-	2004
NISSAN	MURANO	V-6, 3.5 L	2008	-	2007

33009



DODGE	DURANGO	V-8, 5.9 L	2003	-	2003
DODGE	DURANGO	V-8, 5.2 L	1999	-	1999
JEEP	GRAND CHEROKEE	V-6, 4.0 L	2003	-	2003
JEEP	WRANGLER	6 CIL, 4.0 L	2003	-	2002

FORD	MUSTANG	V-6, 3.8 L	2001	-	1996
FORD	WINDSTAR	V-6, 3.8 L	2003	-	2001
JEEP	GRAND CHEROKEE	6 CIL, 4.0 L	2002	-	1999
JEEP	CHEROKEE	6 CIL, 4.0 L	2000	-	1999
FORD	EXPLORER	V-8, 5.0 L	2000	-	2000
FORD	WINDSTAR	V-6, 3.0 L	1998	-	1998

33019



CHEVROLET	SILVERADO	V-8, 5.3 L	2000	-	2000
CHEVROLET	EXPRESS CARGO VAN	V-6, 4.3 L	2007	-	2010
CHEVROLET	BLAZER	V-6, 4.3 L	2005	-	1996
CHEVROLET	EXPRESS	V-8, 5.0 L	2002	-	2000
CHEVROLET	EXPRESS	V-8, 5.7 L	2002	-	1999
CHEVROLET	EXPRESS CARGO VAN	V-8, 5.7 L	2000	-	1998
CHEVROLET	EXPRESS VAN	V-6, 4.3 L	2000	-	1998
CHEVROLET	EXPRESS VAN PASAJEROS	V-6, 4.3 L	2000	-	1998
CHEVROLET	S-10	V-6, 4.3 L	2002	-	1996
CHEVROLET	SILVERADO	V-8, 4.8 L	2007	-	2002
CHEVROLET	EXPRESS	V-6, 4.3 L	2002	-	2001
CHEVROLET	SILVERADO	V-8, 6.0 L	2000	-	2000
CHEVROLET	SUBURBAN	V-8, 5.7 L	1999	-	1996
CHEVROLET	SILVERADO	V-6, 4.3 L	2007	-	2010

33029



FORD	MUSTANG	V-8, 4.6 L	2001	-	1999
------	---------	------------	------	---	------

33069

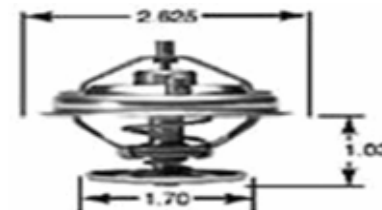

AUDI	A4	V-6, 2.8 L	2000	-	1998
------	----	------------	------	---	------



## Aplicación por Producto

AUDI	A8	V-8, 4.2 L	2006	-	1999
VOLKSWAGEN	JETTA	V-6, 2.8 L	2003	-	2003
AUDI	A8 QUATTRO	V-8, 4.2 L	2001	-	1999
AUDI	A8	V-8, 3.7 L	1999	-	1998
AUDI	A6	V-6, 2.8 L	1998	-	1998
AUDI	ALLROAD QUATTRO	V-6, 2.7 L	2006	-	2003
AUDI	S4 QUATTRO	V-6, 2.7 L	2002	-	2000

**33189**



**33078**



SAAB	9-5	V-6, 3.0 L	2002	-	2002
SAAB	9-5	4 CIL, 2.3 L	2007	-	2002
FORD	MUSTANG	V-8, 4.6 L	2003	-	2003
SAAB	9-3	4 CIL, 2.3 L	2002	-	2001
SAAB	9-3	4 CIL, 2.0 L	2007	-	2002

**33208**



VOLKSWAGEN	GOLF	V-6, 2.8 L	2000	-	2000
FORD	MUSTANG	V-6, 4.0 L	2007	-	2005
VOLKSWAGEN	JETTA	V-6, 2.8 L	2000	-	1999
VOLKSWAGEN	GTI	V-6, 2.8 L	1999	-	1999

**33079**



VOLKSWAGEN	GOLF	4 CIL, 2.0 L	1999	-	1999
VOLKSWAGEN	CABRIO	4 CIL, 2.0 L	1999	-	1999
VOLKSWAGEN	JETTA	4 CIL, 2.0 L	1999	-	1999

**33209**



FORD	MUSTANG	V-6, 4.0 L	2008	-	2010
VOLKSWAGEN	PASSAT	V-6, 2.8 L	2004	-	2004
FORD	EXPLORER SPORT TRAC	V-6, 4.0 L	2006	-	2009
FORD	RANGER	V-6, 4.0 L	2001	-	2001
AUDI	A6	V-6, 2.8 L	2001	-	2001
MERCEDES BE	SLK230	4 CIL, 2.3 L	2000	-	2000
FORD	EXPLORER	V-6, 4.0 L	2007	-	2009
AUDI	A4	4 CIL, 1.8 L	2001	-	2001
FORD	EXPLORER	V-8, 4.6 L	2003	-	2002

**33188**

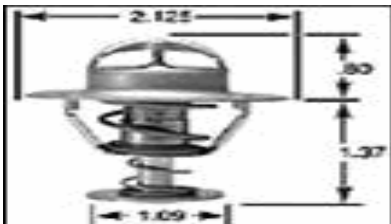

VOLVO	C70	5 CIL, 2.3 L	2004	-	2004
-------	-----	--------------	------	---	------

VOLVO	C70 T5	5 CIL, 2.3 L	2000	-	2000
VOLVO	S40	4 CIL, 1.9 L	2004	-	2000
VOLVO	S60	5 CIL, 2.3 L	2001	-	2001
VOLVO	S60	5 CIL, 2.4 L	2003	-	2001
VOLVO	C70	5 CIL, 2.3 L	2000	-	1999
VOLVO	S60	5 CIL, 2.5 L	2006	-	2004
VOLVO	C70	5 CIL, 2.4 L	2000	-	1999
VOLVO	S70	5 CIL, 2.3 L	2000	-	1999
VOLVO	S70	5 CIL, 2.4 L	2000	-	1999
VOLVO	S80	6 CIL, 2.9 L	2000	-	1999
VOLVO	V40	4 CIL, 1.9 L	2001	-	2000
VOLVO	V70	5 CIL, 2.3 L	2001	-	1999
VOLKSWAGEN	GOLF	4 CIL, 1.8 L	1997	-	1997
VOLKSWAGEN	GTI	V-6, 2.8 L	2001	-	2000
VOLVO	V70	5 CIL, 2.4 L	2001	-	1999
VOLKSWAGEN	JETTA	V-6, 2.8 L	2001	-	2001

## Aplicación por Producto

VOLKSWAGEN	BORA	4 CIL, 1.9 L DIESE2007	-	2007
VOLKSWAGEN	JETTA	4 CIL, 1.9 L DIESE2005	-	2000

**33238**

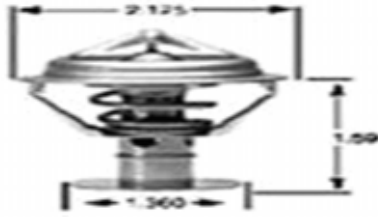

MERCURY	SABLE	V-6, 3.0 L	1998	-	1996
FORD	IKON	4 CIL, 1.6 L	2006	-	2007
LINCOLN	MKZ	V-6, 3.5 L	2008	-	2007
FORD	COURIER	4 CIL, 1.6 L	2008	-	2003
LINCOLN	AVIATOR	V-8, 4.6 L	2003	-	2005
FORD	KA	4 CIL, 1.6 L	2006	-	2007
MERCURY	MILAN	V-6, 3.0 L	2009	-	2009
FORD	FUSION	V-6, 3.0 L	2009	-	2009
FORD	FIVE HUNDRED	V-6, 3.0 L	2007	-	2007
FORD	FIESTA	4 CIL, 1.6 L	2002	-	2010
FORD	EDGE	V-6, 3.5 L	2007	-	2010
FORD	ESCAPE	V-6, 3.0 L	2007	-	2010
LINCOLN	MKX	V-6, 3.5 L	2008	-	2007

**33248**



MERCURY	MILAN	V-6, 3.0 L	2007	-	2006
FORD	CONTOUR	V-6, 2.5 L	2000	-	1997
FORD	FUSION	V-6, 3.0 L	2008	-	2007
MERCURY	SABLE	V-6, 3.0 L	2005	-	2003
LINCOLN	LS	V-6, 3.0 L	2001	-	2000
MERCURY	MYSTIQUE	V-6, 2.5 L	2000	-	1998
MAZDA	MAZDA 6	V-6, 3.0 L	2008	-	2008
MERCURY	MARINER	V-6, 3.0 L	2008	-	2009
FORD	ESCAPE	V-6, 3.0 L	2002	-	2001

**33259**



CHEVROLET	AVEO	4 CIL, 1.6 L	2008	-	2009
-----------	------	--------------	------	---	------

**33299**



FORD	ESCORT	4 CIL, 2.0 L	2002	-	1997
FORD	RANGER	4 CIL, 2.3 L	1997	-	1997
FORD	RANGER	4 CIL, 2.5 L	2001	-	1999

**33329**

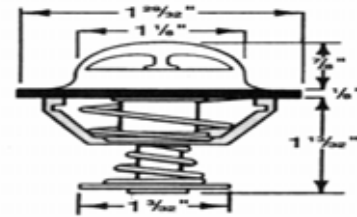

CHEVROLET	MONTE CARLO	V-6, 3.4 L	2005	-	2004
PONTIAC	MONTANA	V-6, 3.5 L	2006	-	2006
CHEVROLET	IMPALA	V-6, 3.8 L	2005	-	2005
CHEVROLET	UPLANDER	V-6, 3.5 L	2007	-	2005
CHEVROLET	EXPRESS	V-8, 8.1 L	2002	-	2001
CHEVROLET	SUBURBAN	V-8, 8.1 L	2002	-	2002
CHEVROLET	MALIBU	V-6, 3.1 L	2003	-	1997
CHEVROLET	MALIBU	V-6, 3.5 L	2006	-	2004
PONTIAC	AZTEK	V-6, 3.4 L	2005	-	2001
CHEVROLET	SILVERADO	V-8, 8.1 L	2001	-	2001
PONTIAC	TORRENT	V-6, 3.4 L	2008	-	2006
CHEVROLET	P-30	V-8, 7.4 L	1999	-	1996
PONTIAC	GRAND AM	V-6, 3.1 L	1998	-	1997
CHEVROLET	C y K SERIES PICKUP	V-8, 7.4 L	2000	-	1999
CHEVROLET	C y K SERIES PICKUP	V-8, 8.1 L	2002	-	2001
CHEVROLET	EQUINOX	V-6, 3.4 L	2007	-	2005
CHEVROLET	EXPRESS	V-8, 7.4 L	1999	-	1999
CHEVROLET	LUMINA	V-6, 3.1 L	1998	-	1998
CHEVROLET	SUBURBAN	V-8, 7.4 L	2000	-	1996
PONTIAC	GRAND PRIX	V-6, 3.1 L	2002	-	1997

## Aplicación por Producto

OLDSMOBILE	SILHOUETTE	V-6, 3.4 L	1996 - 1996
CHEVROLET	VENTURE	V-6, 3.4 L	2005 - 1997
CHEVROLET	IMPALA	V-6, 3.4 L	2005 - 2000
PONTIAC	GRAND AM	V-6, 3.4 L	2005 - 1999

**33339**



FORD	ESCAPE	4 CIL, 2.0 L	2002 - 2001
FORD	FOCUS	4 CIL, 2.0 L	2004 - 2000
FORD	CONTOUR	4 CIL, 2.0 L	2000 - 1997
MERCURY	MYSTIQUE	V-6, 2.5 L	1997 - 1997
FORD	CONTOUR	6 CIL, 2.0 L	1996 - 1996
FORD	ZX2	4 CIL, 2.0 L	2001 - 2000
FORD	ESCORT	4 CIL, 2.0 L	2000 - 1998

**33429**



CHEVROLET	CAMARO Z28	V-6, 3.8 L	2002 - 1996
PONTIAC	GRAND PRIX	V-6, 3.8 L	2005 - 1997
OLDSMOBILE	EIGHTY EIGHT	V-6, 3.8 L	1999 - 1998
CHEVROLET	LUMINA	V-6, 3.4 L	1996 - 1996
CHEVROLET	MONTE CARLO	V-6, 3.8 L	2005 - 2004
CHEVROLET	IMPALA	V-6, 3.8 L	2004 - 2000

**33469**



FORD	FREESTAR	V-6, 4.2 L	2007 - 2004
MERCURY	GRAND MARQUIS	V-8, 4.6 L	2004 - 2000
FORD	LOBO	V-8, 4.6 L	2007 - 2010
FORD	LOBO	V-8, 5.4 L	2007 - 2010
LINCOLN	MARK LT	V-8, 5.4 L	2008 - 2007
LINCOLN	NAVIGATOR	V-8, 5.4 L	2002 - 2009

FORD	SUPER DUTY VAN	V-8, 4.6 L	2003 - 2003
FORD	SUPER DUTY VAN	V-6, 4.2 L	2001 - 2003
FORD	EXPLORER SPORT TRAC	V-8, 4.6 L	2007 - 2009
FORD	SUPER DUTY PICKUP	V-10, 6.8 L	2000 - 2003
FORD	SUPER DUTY PICKUP	V-8, 5.4 L	2000 - 2000
FORD	SUPER DUTY VAN	V-10, 6.8 L	2002 - 2000
LINCOLN	TOWN CAR	V-8, 4.6 L	2004 - 2004
FORD	EXPEDITION	V-8, 5.4 L	2002 - 2009
FORD	F-550 SUPER DUTY	V-10, 6.8 L	2008 - 2010
FORD	MUSTANG	V-8, 4.6 L	2004 - 2009
FORD	E SERIES VAN	V-6, 4.2 L	2003 - 2000
FORD	E SERIES VAN	V-8, 4.6 L	2006 - 2010
FORD	E SERIES VAN	V-8, 5.4 L	2007 - 2010
FORD	EXCURSION	V-10, 6.8 L	2005 - 2001
FORD	EXPEDITION	V-8, 4.6 L	2004 - 1997
FORD	FREESTAR	V-6, 3.9 L	2007 - 2004
FORD	EXPLORER	V-8, 4.6 L	2007 - 2009
FORD	F-150	V-8, 4.6 L	2009 - 2010
FORD	F-450 SUPER DUTY	V-10, 6.8 L	2006 - 2010
FORD	F-350 SUPER DUTY	V-8, 5.4 L	2006 - 2009
FORD	F-250	V-8, 4.6 L	2006 - 1998
FORD	SUPER DUTY VAN	V-8, 5.4 L	2001 - 2000
FORD	F-150	V-6, 4.2 L	2006 - 1999
FORD	F SERIES PICKUP	V-8, 5.4 L	2002 - 2000
FORD	F SERIES PICKUP	V-8, 4.6 L	2001 - 2000
FORD	F SERIES PICKUP	V-6, 4.2 L	2001 - 2000
FORD	CROWN VICTORIA	V-8, 4.6 L	2004 - 2003

**33478**



SUBARU	B9 TRIBECA	6 CIL, 3.0 L	2007 - 2006
--------	------------	--------------	-------------

**33479**



FORD	EXCURSION	V-8, 5.4 L	2002 - 2002
------	-----------	------------	-------------

## Aplicación por Producto

**33509**



DODGE	RAM MAXI VAN 3500	V-8, 5.9 L	2002 - 2002
JEEP	CHEROKEE	4 CIL, 2.5 L	1998 - 1996
FORD	WINDSTAR	V-6, 3.8 L	2000 - 2000
FORD	WINDSTAR	V-6, 3.0 L	1998 - 1998
JEEP	CHEROKEE	6 CIL, 4.0 L	2001 - 1996
FORD	RANGER	V-6, 3.0 L	2002 - 1996
FORD	F-450 SUPER DUTY	V-8, 7.5 L	1997 - 1997
FORD	EXPLORER	V-8, 5.0 L	2001 - 1998
FORD	AEROSTAR	V-6, 3.0 L	1997 - 1997
FORD	MUSTANG	V-6, 3.8 L	2001 - 1998
DODGE	RAM MAXI WAGON 3500	V-8, 5.9 L	2002 - 2002
DODGE	RAM MAXI VAN 1500	V-6, 3.9 L	2002 - 2002
DODGE	RAM 2500	V-8, 5.9 L	2002 - 2002
DODGE	RAM 1500	V-6, 3.9 L	2001 - 1999
DODGE	DURANGO	V-8, 5.9 L	1999 - 1999
DODGE	DURANGO	V-8, 5.2 L	2000 - 1998
DODGE	DURANGO	V-6, 3.9 L	1999 - 1999
DODGE	RAM WAGON 3500	V-8, 5.2 L	2000 - 2000
JEEP	GRAND CHEROKEE	V-8, 5.9 L	1998 - 1998
JEEP	WRANGLER	6 CIL, 4.0 L	2001 - 1999
MAZDA	MAZDA 6	V-6, 3.0 L	2007 - 2006
MERCURY	SABLE	V-6, 3.0 L	2002 - 1999

**33518**



AUDI	A8	V8, 4.2 L	2008 - 2009
MERCEDES BE	E320	V-6, 3.2 L	2000 - 2000

**33568**



HONDA	CIVIC	4 CIL, 1.6 L	2000 - 1998
HONDA	CIVIC HIBRIDO	4 CIL, 1.3 L	2005 - 2010
HONDA	CR-V	4 CIL, 2.0 L	2001 - 1999
HONDA	ACCORD	4 CIL, 2.3 L	2002 - 1999
HONDA	CIVIC	4 CIL, 1.7 L	2001 - 2001

**335685**



HONDA	FIT	4 CIL, 1.5 L	2009 - 2010
HONDA	CITY	4 CIL, 1.5 L	2010 - 2010

**33578**



DODGE	VIPER	V-10, 8.0 L	2002 - 1998
-------	-------	-------------	-------------

**33708**



TOYOTA	CAMRY	4 CIL, 2.2 L	2001 - 2001
NISSAN	TSURU	4 CIL, 1.6 L	2000 - 2010

**33737**



NISSAN	PATHFINDER	V-6, 3.3 L	2000 - 1999
NISSAN	QUEST	V-6, 3.0 L	1998 - 1997
NISSAN	QUEST	V-6, 3.3 L	1999 - 1999

## Aplicación por Producto

NISSAN XTERRA V-6, 3.3 L 2001 - 2000

**33738**

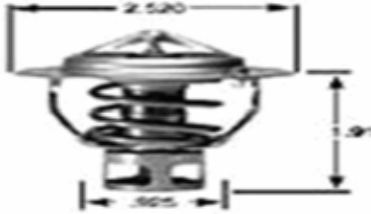

NISSAN	FRONTIER	V-6, 3.3 L	2004 - 1999
NISSAN	QUEST	6 CIL, 3.3 L	2002 - 2002
NISSAN	QUEST	V-6, 3.3 L	2001 - 2000
NISSAN	XTERRA	V-6, 3.3 L	2002 - 2002
NISSAN	FRONTIER	4 CIL, 2.4 L	2001 - 1999

**33747**



NISSAN	TSURU	4 CIL, 2.0 L	1999 - 1999
NISSAN	SENTRA	4 CIL, 2.0 L	2001 - 1999
NISSAN	FRONTIER	4 CIL, 2.4 L	2002 - 2002
NISSAN	XTERRA	4 CIL, 2.4 L	2004 - 2000

**33748**



NISSAN FRONTIER 4 CIL, 2.4 L 2004 - 2003

**33778**



CHEVROLET TRACKER 4 CIL, 1.6 L 2000 - 1997

**33779**



FORD RANGER V-6, 4.0 L 2000 - 1999

**33788**



PONTIAC FIREBIRD TRANS AM V-8, 5.7 L 1997 - 1997

**33798**



TOYOTA YARIS 4 CIL, 1.5 L 2008 - 2005

**33808**



CHEVROLET	SUBURBAN	V-8, 5.3 L	2009 - 2010
CHEVROLET	SUBURBAN	V-8, 6.0 L	2009 - 2010
CADILLAC	ESCALADE	V-8 6.2 L	2009 - 2010
CHEVROLET	SILVERADO	V-8, 5.3 L	2009 - 2010
CADILLAC	SEVILLE	V-8, 4.6 L	2004 - 1998
CHEVROLET	SILVERADO	V-8, 4.8 L	2009 - 2010
CHEVROLET	TAHOE	V-8, 5.3 L	2009 - 2010
CADILLAC	DEVILLE	V-8, 4.6 L	2005 - 1997
CHEVROLET	AVALANCHE	V-8, 5.3 L	2009 - 2010

33828



PONTIAC	SUNFIRE	4 CIL, 2.4 L	2002 - 1996
CHEVROLET	CAVALIER	4 CIL, 2.2 L	2001 - 1999
CHEVROLET	MALIBU	4 CIL, 2.4 L	1998 - 1997
PONTIAC	GRAND AM	4 CIL, 2.4 L	2001 - 1998
CHEVROLET	CAVALIER	4 CIL, 2.4 L	1999 - 1996
PONTIAC	GRAND AM	V-6, 3.4 L	2001 - 2001
PONTIAC	SUNFIRE	4 CIL, 2.2 L	2002 - 1996

33868



TOYOTA	RAV 4	V-6, 3.5 L	2008 - 2010
TOYOTA	4 RUNNER	V-6, 3.4 L	2002 - 2002
TOYOTA	SOLARA	V-6, 3.3 L	2006 - 2005
MITSUBISHI	OUTLANDER	4 CIL, 2.4 L	2006 - 2004
TOYOTA	MATRIX	4 CIL, 1.8 L	2008 - 2003
TOYOTA	COROLLA	4 CIL, 1.8 L	2008 - 2002
TOYOTA	CAMRY	V-6, 3.0 L	2006 - 2001
TOYOTA	SIENNA	V-6, 3.0 L	2003 - 2003
MITSUBISHI	GALANT	4 CIL, 2.4 L	2007 - 2004
TOYOTA	SIENNA	V-6, 3.3 L	2006 - 2004
TOYOTA	RAV 4	4 CIL, 2.4 L	2006 - 2003
TOYOTA	RAV 4	4 CIL, 2.0 L	2003 - 2003
TOYOTA	CAMRY	4 CIL, 2.4 L	2008 - 2003
MITSUBISHI	LANCER	4 CIL, 2.4 L	2006 - 2004

33849



CHRYSLER	GRAND VOYAGER	V-6, 3.3 L	2000 - 2000
CHRYSLER	TOWN & COUNTRY	V6, 4.0 L	2008 - 2010
CHRYSLER	SEBRING	4 CIL, 2.4 L	2006 - 1996
CHRYSLER	PT CRUISER	4 CIL, 2.4 L	2007 - 2010
CHRYSLER	PACIFICA	V-6, 4.0 L	2008 - 2007
MINI	COOPER	4 CIL, 1.6 L	2006 - 2008
CHRYSLER	GRAND VOYAGER	V-6, 3.8 L	2000 - 2000
CHRYSLER	TOWN & COUNTRY	V-6, 3.8 L	1999 - 1999
DODGE	STRATUS	V-6, 2.5 L	1999 - 1999
DODGE	CARAVAN	4 CIL, 2.4 L	1997 - 1997
CHRYSLER	CIRRUS	4 CIL, 2.4 L	2005 - 1996
DODGE	NITRO	V-6, 4.0 L	2009 - 2010
DODGE	JOURNEY	V-6, 3.5 L	2009 - 2010
JEEP	WRANGLER	V-6, 3.8 L	2007 - 2009
DODGE	NEON	4 CIL, 2.4 L	2006 - 2004

33877



HONDA	ACCORD	V-6, 3.0 L	2002 - 1998
-------	--------	------------	-------------

33878



MITSUBISHI	OUTLANDER	V-6, 3.0 L	2007 - 2008
INFINITI	Q45	V-8, 4.5 L	2002 - 2002
INFINITI	INFINITI Q45	V-8, 4.5 L	2002 - 2002
NISSAN	TITAN	V-8, 5.6 L	2008 - 2009
MITSUBISHI	MONTERO SPORT	V-6, 3.5 L	2004 - 2004
MITSUBISHI	ECLIPSE	V-6, 3.0 L	2005 - 2004
MITSUBISHI	ECLIPSE	V-6, 3.8 L	2007 - 2008
NISSAN	ARMADA	V-8, 5.6 L	2006 - 2010
MITSUBISHI	ENDEAVOR	V-6, 3.8 L	2007 - 2004

33857



SUBARU	IMPREZA	4 CIL, 2.5 L	2007 - 2006
--------	---------	--------------	-------------



## Aplicación por Producto

CHRYSLER	SEBRING	V-6, 2.5 L	2000	-	1997
MITSUBISHI	GALANT	V-6, 3.8 L	2007	-	2004
TOYOTA	SEQUOIA	V-8, 4.7 L	2008	-	2007
CHRYSLER	SEBRING	V-6, 3.0 L	2006	-	2004
TOYOTA	4 RUNNER	V-8, 4.7 L	2006	-	2003
DODGE	STRATUS	V-6, 3.0 L	2002	-	2001
TOYOTA	LAND CRUISER	V-8, 4.7 L	2007	-	2003
MITSUBISHI	MONTERO	V-6, 3.8 L	2007	-	2004
CHRYSLER	CIRRUS	V-6, 2.5 L	2000	-	1996

### 33909



FORD	F-450 SUPER DUTY	V-8, 7.3 L	2003	-	2001
FORD	SUPER DUTY PICKUP	V-8, 7.3 L	2000	-	2000
FORD	SUPER DUTY VAN	V-8, 7.3 L	2001	-	2000

### 33910



CHEVROLET	SILVERADO	V-8, 5.3 L	2001	-	2001
CHEVROLET	AVALANCHE	V-8, 5.3 L	2003	-	2002
PONTIAC	FIREBIRD TRANS AM	V-8, 5.7 L	2002	-	1998
CHEVROLET	CORVETTE	V-8, 5.7 L	2003	-	1997
CHEVROLET	SUBURBAN	V-8, 6.0 L	2001	-	2000
CHEVROLET	SILVERADO	V-8, 6.0 L	2007	-	2001
CHEVROLET	SUBURBAN	V-8, 5.3 L	2001	-	2000
CHEVROLET	CAMARO Z28	V-8, 5.7 L	2002	-	2000

### 33912



NISSAN	370Z	V-6, 3.7 L	2009	-	2009
INFINITI	INFINITI I30	V-6, 3.0 L	2001	-	1997

### 33914



HONDA	ACCORD	V-6, 3.5 L	2008	-	2010
ACURA	MDX	V-6, 3.7 L	2007	-	2010
HONDA	RIDGELINE	V-6, 3.5 L	2006	-	2006
HONDA	ODYSSEY	V-6, 3.5 L	2007	-	1999
ACURA	MDX	V-6, 3.5 L	2006	-	2006
ACURA	TL	V-6, 3.7 L	2009	-	2009
ACURA	TL	V-6, 3.5 L	2008	-	2009
HONDA	ACCORD	V-6, 3.0 L	2003	-	2003
ACURA	RL	V-6, 3.5 L	2008	-	2006
ACURA	TL	V-6, 3.2 L	2008	-	2006
HONDA	PILOT	V-6, 3.5 L	2007	-	2003
ACURA	RL	V-6, 3.7 L	2009	-	2010

### 33915

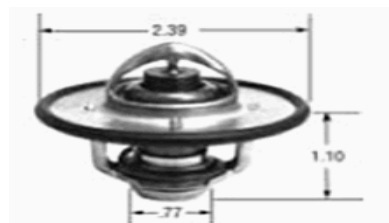

DODGE	RAM 4000	V-6, 6.7 L DIESEL	2008	-	2009
DODGE	RAM 4000	V-6, 5.9 L DIESEL	2008	-	2008

### 33917



DODGE	INTREPID	V-6, 2.7 L	1998	-	1998
CHRYSLER	CONCORDE	V-6, 2.7 L	2000	-	1998
DODGE	STRATUS	V-6, 2.7 L	2002	-	2001

**33918**

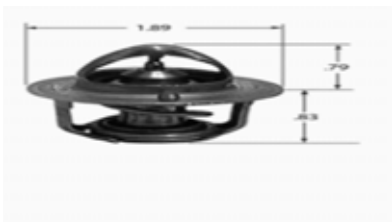

CHRYSLER	CONCORDE	V-6, 3.5 L	2002 - 2002
CHRYSLER	300 C	V-6, 3.5 L	2006 - 2005
DODGE	INTREPID	V-6, 3.5 L	2000 - 2000
CHRYSLER	300 C	V-8, 5.7 L	2006 - 2005
DODGE	INTREPID	V-6, 3.2 L	2001 - 1998
CHRYSLER	CONCORDE	V-6, 3.2 L	2001 - 1998
DODGE	CHARGER	V-6, 3.5 L	2008 - 2007
CHRYSLER	300M	V-6, 3.5 L	2004 - 1999
CHRYSLER	300 C	V-8, 6.1 L	2006 - 2005

**33919**



DODGE	DAKOTA	V-6, 3.7 L	2008 - 2007
DODGE	DURANGO	V-6, 3.7 L	2004 - 2004
JEEP	GRAND CHEROKEE	V-6, 3.7 L	2007 - 2005
JEEP	LIBERTY	V-6, 3.7 L	2007 - 2002
JEEP	GRAND CHEROKEE	V-8, 4.7 L	2007 - 1999
DODGE	DURANGO	V-8, 4.7 L	2006 - 2001
DODGE	RAM 2500	V-8, 4.7 L	2004 - 2009
DODGE	RAM 2500	V-8, 4.7L	2003 - 2002
DODGE	NITRO	V-6, 3.7 L	2008 - 2007
DODGE	DURANGO	V-8, 5.7 L	2008 - 2009
DODGE	RAM 1500	V-6, 3.7 L	2005 - 2009

**33920**



CHEVROLET	TRACKER	4 CIL, 2.0 L	2002 - 1999
SUZUKI	SX4	4 CIL, 2.0 L	2009 - 2010
SUZUKI	AERIO	4 CIL, 2.3 L	2006 - 2005

**33922**



CHEVROLET	EXPRESS	V-8, 6.5 L	2000 - 2000
-----------	---------	------------	-------------

**33923**



VOLKSWAGEN	PASSAT	4 CIL, 1.8 L	2005 - 1999
AUDI	A4	4 CIL, 1.8 L	2002 - 1998
VOLKSWAGEN	BEETLE	4 CIL, 1.8 L	2005 - 1999
VOLKSWAGEN	CABRIO	4 CIL, 2.0 L	2002 - 2002
VOLKSWAGEN	GOLF	4 CIL, 1.8 L	2004 - 1999
VOLKSWAGEN	JETTA	4 CIL, 2.0 L	2008 - 2001
VOLKSWAGEN	PASSAT	V-6, 2.8 L	2005 - 2005
VOLKSWAGEN	GTI	4 CIL, 2.0 L	2000 - 1999
VOLKSWAGEN	GOLF	4 CIL, 2.0 L	2006 - 1999
AUDI	TT	4 CIL, 1.8 L	2006 - 2000
VOLKSWAGEN	BEETLE	4 CIL, 2.0 L	2008 - 1998
VOLKSWAGEN	JETTA	4 CIL, 1.8 L	2006 - 2000

**33930**



MERCEDES BE	CLK55	V-8, 5.5 L	2006 - 2001
-------------	-------	------------	-------------

**33934**



## Aplicación por Producto

BMW	Z3	V-6, 2.8 L	2000	-	2000
BMW	325CI	V-6, 2.5 L	2006	-	2001
BMW	545I	V-8, 4.4 L	2005	-	2004
BMW	328I	V-6, 2.8 L	2000	-	2000
BMW	330CI	6 CIL, 3.0 L	2003	-	2001
BMW	X3	6 CIL, 3.0 L	2006	-	2005
BMW	323I	V-6, 2.5 L	2000	-	1999
BMW	323CI	V-6, 2.5 L	2000	-	2000
BMW	X5	6 CIL, 3.0 L	2006	-	2005
BMW	325I	V-6, 2.5 L	2005	-	2001
BMW	Z3	V-6, 2.5 L	2001	-	2000
BMW	Z3	V-6, 3.0 L	2001	-	2001
BMW	Z4	6 CIL, 2.5 L	2003	-	2003
BMW	Z4	6 CIL, 3.0 L	2003	-	2003
BMW	Z4	V-6, 2.5 L	2006	-	2004
BMW	330CI	V-6, 3.0 L	2006	-	2004
BMW	525I	6 CIL, 2.5 L	2005	-	2001
BMW	528I	V-6, 2.8 L	1999	-	1999
BMW	Z4	V-6, 3.0 L	2004	-	2004
BMW	X5	V-6, 3.0 L	2004	-	2004
BMW	530I	6 CIL, 3.0 L	2002	-	2002

### 33937

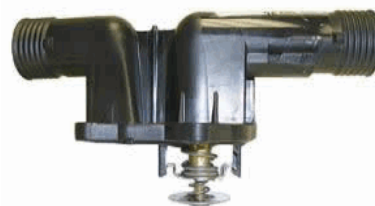

BMW	318TI	4 CIL, 1.9 L	1999	-	1998
BMW	318I	4 CIL, 1.9 L	1998	-	1998

### 33938



HYUNDAI	ATTITUDE	4 CIL, 1.4 L	2008	-	2010
HYUNDAI	ATTITUDE	4 CIL, 1.6 L	2008	-	2010

### 33939



CHEVROLET	TRAILBLAZER	6 CIL, 4.2 L	2007	-	2002
-----------	-------------	--------------	------	---	------

### 33940



NISSAN	350Z	V-6, 3.5 L	2006	-	2006
NISSAN	FRONTIER	V-6, 4.0 L	2007	-	2007
NISSAN	PATHFINDER	V-6, 3.5 L	2002	-	2001
NISSAN	PATHFINDER	V-6, 4.0 L	2007	-	2005
NISSAN	XTERRA	V-6, 4.0 L	2007	-	2007
NISSAN	FRONTIER	V6, 4.0 L	2008	-	2008

### 33935



BMW	740IL	V-8, 4.4 L	2001	-	1998
BMW	X5	V-8, 4.4 L	2004	-	2004
BMW	740I	V-8, 4.4 L	2001	-	1998
BMW	540I	V-8, 4.4 L	2001	-	1998
BMW	X5	V-8, 4.4 L	2000	-	2000

### 33936



BMW	328I	V-6, 2.8 L	1999	-	1998
BMW	328IS	V-6, 2.8 L	1999	-	1998
BMW	528I	V-6, 2.8 L	1998	-	1998
BMW	323IS	V-6, 2.5 L	1999	-	1998

**33941**



NISSAN	ROGUE	4 CIL, 2.5 L	2008	-	2010
JEEP	COMPASS	4 CIL, 2.4 L	2009	-	2008
DODGE	AVENGER	4 CIL, 2.0 L	2007	-	2009
DODGE	AVENGER	4 CIL, 2.4 L	2007	-	2009
DODGE	CALIBER	4 CIL, 2.4 L	2007	-	2009
JEEP	PATRIOT	4 CIL, 2.4 L	2009	-	2008
NISSAN	X-TRAIL	4 CIL, 2.5 L	2008	-	2008
RENAULT	KOLEOS	4 CIL, 2.5 L	2009	-	2010
NISSAN	SENTRA	4 CIL, 2.5 L	2006	-	2010
NISSAN	ALTIMA	4 CIL, 2.5 L	2008	-	2010

**33946**



CHEVROLET	SILVERADO	V-8, 6.6 L	2001	-	2001
-----------	-----------	------------	------	---	------

**33948**



LINCOLN	LS	V-8, 3.9 L	2002	-	2001
---------	----	------------	------	---	------

**33949**



HONDA	CR-V	4 CIL, 2.0 L	2002	-	2002
-------	------	--------------	------	---	------

**33950**



PORSCHE	BOXSTER	6 CIL, 2.7 L	2003	-	2006
---------	---------	--------------	------	---	------

**33951**



**33943**



CHEVROLET	MALIBU	4 CIL, 2.2 L	2007	-	2004
CHEVROLET	CAPTIVA	V-6, 3.6 L	2009	-	2010
CHEVROLET	MALIBU	4 CIL, 2.4 L	2008	-	2010
CHEVROLET	CAPTIVA	4 CIL, 2.4 L	2009	-	2010
CHEVROLET	CAPTIVA	4 CIL, 2.4 L	2008	-	2008
PONTIAC	G4	4 CIL, 2.2 L	2006	-	2006
PONTIAC	G4	4 CIL, 2.4 L	2006	-	2006
CHEVROLET	CAVALIER	4 CIL, 2.2 L	2005	-	2002
PONTIAC	SUNFIRE	4 CIL, 2.2 L	2004	-	2005
PONTIAC	SOLSTICE	4 CIL, 2.4 L	2008	-	2006
PONTIAC	G5	4 CIL, 2.4 L	2008	-	2007
CHEVROLET	HHR	4 CIL, 2.4 L	2008	-	2010
PONTIAC	G5	4 CIL, 2.2 L	2008	-	2007

**33945**



NISSAN	ALTIMA	4 CIL, 2.5 L	2008	-	2010
--------	--------	--------------	------	---	------

## Aplicación por Producto

NISSAN	ALTIMA	V-6, 3.5 L	2006 - 2004
NISSAN	MAXIMA	V-6, 3.5 L	2007 - 2002
NISSAN	MURANO	V-6, 3.5 L	2009 - 2010
NISSAN	QUEST	V-6, 3.5 L	2007 - 2007
NISSAN	QUEST	6 CIL, 3.5 L	2006 - 2004

**33983**



TOYOTA	HIGHLANDER	V-6, 3.5 L	2009 - 2009
TOYOTA	RAV 4	4 CIL, 2.4 L	2007 - 2008
TOYOTA	RAV 4	4 CIL, 2.5 L	2009 - 2010
TOYOTA	SIENNA	V-6, 3.5 L	2009 - 2010

**33952**



**33987**



CHRYSLER	PACIFICA	V-6, 3.5 L	2006 - 2005
CHRYSLER	TOWN & COUNTRY	V-6, 3.8 L	2007 - 2005
CHRYSLER	VOYAGER	V-6, 3.3 L	2007 - 2003
CHRYSLER	PACIFICA	V-6, 3.8 L	2006 - 2005

MITSUBISHI	LANCER	4 CIL, 2.0 L	2007 - 2008
------------	--------	--------------	-------------

**33963**



**33992**



CHEVROLET	TAHOE	V-8, 4.8 L	2007 - 2006
CHEVROLET	AVALANCHE	V-8, 5.3 L	2006 - 2008
GMC	YUKON	V-8, 6.2 L	2009 - 2010
GMC	YUKON	V-8, 5.3 L	2008 - 2007
GMC	SIERRA	V-8, 6.2 L	2009 - 2010
CHEVROLET	TAHOE	V-8, 5.3 L	2008 - 2008
CADILLAC	ESCALADE	V-8 6.2 L	2008 - 2008
CHEVROLET	SUBURBAN	V-8, 6.0 L	2002 - 2003
CHEVROLET	SUBURBAN	V-8, 5.3 L	2003 - 2008
HUMMER	H2	V-8, 6.0 L	2007 - 2006
CHEVROLET	SILVERADO	V-8, 5.3 L	2008 - 2008
GMC	SIERRA	V-8, 5.3 L	2009 - 2010
CHEVROLET	EXPRESS	V-8, 5.3 L	2008 - 2010
CHEVROLET	CORVETTE	V-8, 5.7 L	2004 - 2004
CHEVROLET	CORVETTE	V-8, 6.0 L	2007 - 2005
CHEVROLET	SILVERADO	V-8, 4.8 L	2008 - 2008
HUMMER	H2	V-8, 6.2 L	2008 - 2010
CHEVROLET	EXPRESS	V-8, 6.0 L	2007 - 2010

HONDA	PILOT	V-6, 3.5 L	2008 - 2010
HONDA	RIDGELINE	V-6, 3.5 L	2008 - 2009
HONDA	ODYSSEY	V-6, 3.5 L	2008 - 2010

**34041**



NISSAN	PATHFINDER	V-6, 4.0 L	2008 - 2010
--------	------------	------------	-------------

34042



FORD	FOCUS	4 CIL, 2.0 L	2007 - 2010
------	-------	--------------	-------------

34048



HONDA	CR-V	4 CIL, 2.4 L	2007 - 2009
-------	------	--------------	-------------

34044



FORD	FUSION	4 CIL, 2.3 L	2008 - 2009
FORD	RANGER	4 CIL, 2.3 L	2008 - 2010
FORD	ESCAPE	4 CIL, 2.5 L	2009 - 2010

34050



HONDA	ACCORD	4 CIL, 2.4 L	2008 - 2010
ACURA	TSX	4 CIL, 2.4 L	2009 - 2009

34045

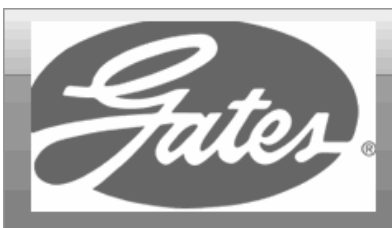

CHEVROLET	COLORADO	5 CIL, 3.7 L	2007 - 2007
CHEVROLET	COLORADO	4 CIL, 2.9 L	2007 - 2007
GMC	CANYON	5 CIL, 3.7 L	2008 - 2007

34051



TOYOTA	TACOMA	V-6, 4.0 L	2008 - 2006
--------	--------	------------	-------------

34046



MAZDA	CX-7	4 CIL, 2.3 L	2006 - 2008
MAZDA	MAZDA 6	4 CIL, 2.3 L	2008 - 2008
MAZDA	MAZDA 3	4 CIL, 2.0 L	2008 - 2009
MAZDA	MAZDA 3	4 CIL, 2.3 L	2008 - 2006

34053



DODGE	RAM 2500	V-8, 5.7 L	2008 - 2009
DODGE	DURANGO	V-8, 5.7 L	2007 - 2006
DODGE	CHARGER	V-8, 6.1 L	2008 - 2009
CHRYSLER	ASPEN	V-8, 5.7 L	2007 - 2009
JEEP	GRAND CHEROKEE	V-8, 6.1 L	2007 - 2009
JEEP	GRAND CHEROKEE	V-8, 5.7 L	2007 - 2009
JEEP	COMMANDER	V-8, 5.7 L	2008 - 2009
DODGE	CHARGER	V-8, 5.7 L	2008 - 2009



34054



PONTIAC	G6	V-6, 3.5 L	2006	-	2006
PONTIAC	G6	V-6, 3.9 L	2006	-	2006
CHEVROLET	MALIBU	V-6, 3.5 L	2007	-	2007
CHEVROLET	UPLANDER	V-6, 3.9 L	2006	-	2009

TH03188G1



NISSAN	URVAN	4 CIL, 2.4 L	2000	-	2008
--------	-------	--------------	------	---	------

365685



HONDA	CIVIC	4 CIL, 1.8 L	2008	-	2010
-------	-------	--------------	------	---	------

TH11287G1

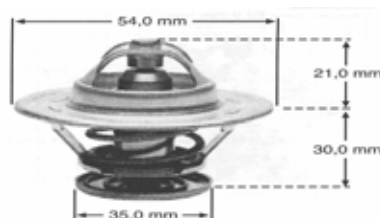

VOLKSWAGEN	POINTER	4 CIL, 2.0 L	2006	-	2002
AUDI	A3	4 CIL, 2.0 L	2007	-	2008
VOLKSWAGEN	POINTER	4 CIL, 1.8 L	2008	-	2007
VOLKSWAGEN	POINTER	4 CIL, 1.8 L	2006	-	2000

48689



FORD	ESCAPE	4 CIL, 2.3 L	2007	-	2005
------	--------	--------------	------	---	------

TH12988G1



NISSAN	URVAN	4 CIL, 2.5 L	2009	-	2010
--------	-------	--------------	------	---	------

48792



DODGE	RAM 3500	V-8, 5.7 L	2007	-	2003
-------	----------	------------	------	---	------

TH13287G1

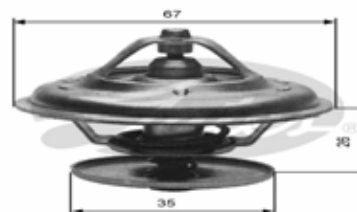

VOLKSWAGEN	CRAFTER	5 CIL, 2.5 L TDI	2008	-	2010
------------	---------	------------------	------	---	------

### TH23389G1

MERCEDES BE SPRINTER 4 CIL, 2.2 L CDI 2007 - 2006



NISSAN	PLATINA	4 CIL, 1.6 L	2008 - 2010
NISSAN	APRIO	4 CIL, 1.6 L	2008 - 2010
RENAULT	CLIO	4 CIL, 2.0 L SPOR	2006 - 2003
RENAULT	KANGOO	4 CIL, 1.6 L	2008 - 2010
RENAULT	KANGOO EXPRESS	4 CIL, 1.6 L	2008 - 2009
RENAULT	MEGANE	4 CIL, 2.0 L	2009 - 2009
RENAULT	MEGANE	4 CIL, 2.0 L	2008 - 2001
RENAULT	SCENIC	4 CIL, 2.0 L	2009 - 2009
RENAULT	SCENIC	4 CIL, 2.0 L	2007 - 2001
RENAULT	CLIO	4 CIL, 1.6 L	2008 - 2009

### TH26988G1



FORD	TRANSIT	4 CIL, 2.2 L TDI	2008 - 2008
FORD	TRANSIT	4 CIL, 2.2 L	2009 - 2010

### TH35087G1



MERCEDES BE	SPRINTER	4 CIL, 2.2 L CDI	2008 - 2010
-------------	----------	------------------	-------------

### TH-35087G1



MERCEDES BE	SPRINTER	5 CIL, 2.7 L CDI	2005 - 2003
-------------	----------	------------------	-------------

TCK124M



Hyundai H100 4 Cil. 2.4 Lts. Años 2003 al 2005

TCK1570M



Pontiac MATIZ G2 de 4 Cil. 1.0 Lts. Años 2003 al 2009

TCK1565M



Renault Megane y Scenic 4 Cil. 2.0 Lts. Años 2004 al 2009

TCK260M



Volkswagen Pointer 4 Cil. 1.8 Lts. Año 1999 al 2009

TCK282M



Hyundai Attitude 4 Cil. 1.6 Lts. Año 2006 al 2010  
Verna 4 Cil. 1.6 Lts. Año 2005 al 2006

TCK333M



Volkswagen Eurovan 4 Cil. 1.9 Lts. Diesel  
Año 2005 al 2009  
Jetta 4 Cil. 1.9 Lts. Diesel Año 2005 al 2007

TCK324M















Hyundai Verna 4 Cil. 1.5 Lts. Año 2004 al 2006







TCK739M









Volkswagen Eurovan 5 Cil. 2.5 Lts. Año 2000 al 2003







					
021145299C	38175	037260849C	K060455	038903315C	38192
021145933H	7DPK1363	037260849C / 6PK1153	K060455	038903315F	38148
022145299E	38317	037260849C / 6PK1154	K060455	03G903137B	K060415
022145933P	DK070817	037903137E	K060385	04668247AB	K040517
022145933T	K060637	037903137E	K060355	04668380AA	K040345
025109119C	T317	037903137G	K060385	04668382AB	K040560
026109119B	T260	037903315B	38018	04668382AB	K040510
026109243E	T41079	037903315C	38147	04792532AA	K040353
026109243L	T41079	038109119M	T321	04792746AB	K060525
028109243F	T43006	038109119P	T333	048109119D	T262
028145278E	38087	038109243M	T43091	04854033AB	K060882
028903119AA	37010P	038109243M	T41229	04861322AB	K060825
030109119AB	T1548	038109243N	T43007	04861322AC	K060825
030109243D/F/J/K/	TPG-2300 4	038109244J	T43091	04892150AA	K060529
030145299C	TMV-2300 4	038109244J	T41229	04892173AA	K060630
030145299C,F	TMV-2300 4	038903119A	37013P	04892749AB	K060529
030145933AB	K060297	038903119T	37013P	058109119C	T317
037145271E	7270	038903137G	K060355	058903133D	38151
037145271F	7295	038903137J	K060653	066145933J	DK060519







					
06A109119C	T306	06B109199F	T306	078903133AB	38193
06A109119C	T296	06B260849A	K040338	078903137BC	K060739
06A109479B	T43010	06B260849A	K040335	078903137BJ	K060739
06A109479B	T41079	06B903133	38207	078903137BL	K060730
06A145933D	K060441	06B903133	38193	078903341J	38078
06A260849C	DK060472	06B903137D	K060625	079903137AA	K050440
06A260849C	6DPK1200	06B903137E	K050510	07D145933E	K071013
06A260849E	K060441	06D109119B	T334	07K145933C	K050365
06A260849E	DK060472	06E903137A	K060950	07K145933E	K050418
06A260849E	6PDK1200	06F260849L	K060415	07K145933E / 5PK925	K050365
06A260849E	6DPK1200	074109119R	T739	07K145933F	DK050610
06A260849E / 68381D	6DPK1200	074145278E	38079	07K145933G	K050368
06A260849K	K060406	074145278F	38080	0816F4	T1503
06A903315D	38148	074145933AL	K060532	0816H3	T1596
06A903315E	38148	074260849AF / 6PK2213	K060870	0816H6	T1596
06A903315F	38148	074903137AS	K060815	1004297	T1086
06B109119A	T306	076260849B	K061020	10118713	38024
06B109119B	T306	078109119H	T297	10129560	38006
06B109119F	T306	0789031133AB	38193	10129560	38001







					
10141997	38187	11281717188	38221	11287832327	K060578
10141997	38001	11281717210	38220	11720 8J000	K060883
10179211	38001	11281720039	38061	117204P102	K060465
10182356	19026	11281738605	38069	117204Z800	K060434
10229114	38108	11281742858	38063	117205M000	K060435
10342751	31855	11281742859	38066	117206N200	K060888
10342751	31852	11281745545	38219	117206N20A	K060883
1112000770	38225	11281748130	38069	117207500A	K070975
1120198	K060878	11281748131	38071	117208J000	K060883
1122000870	38174	11282245087	38070	117209F610	K060325
1122000970	38174	11287509508	38008	11720AR000	K060772
11281427252	38201	11287509520	K060573	11720B13S0	K040395
11281432104	38223	11287512758	K040338	11720BX015	K030267
11281433571	38224	11287512762	K040340	11720EA001	K060815
11281437475	K060605	11287512971	K040338	11720EA200	K070873
11281702013	38066	11287515865	38063	11720EL00A	K060473
11281704718	38062	11287515867	38018	11720ET00A	K060478
11281706545	K060605	11287520177	K040322	11720F4001	6366L
11281709613	38218	11287539831	K060609	11720JA00A	K060878















					
11720JA10B	K070673	1192588G00	36118	119558J000	38284
11720JG30A	K060711	1192731U05	36087	11955EA20A	38378
11720VJ210	K040360	119275B600	38044	119979792	K060942
1192000QAA / 5PK1747	K050688	119453S510	38037	12456152	38103
1192000QAB	K050435	119454S100	38005	12456152	38008
1192031U02	K060431	1194585	36115	12552358	38143
1192053J00	K060407	1194586G00	38036	12554027	38158
1192053J20	K060408	1194731U05	36087	12554027	38009
119207Y000	K060420	1195031U02	K040305	12554701	38260
1192088R00	K040358	119504Z800	K040330	12554701	38009
119209F605	K060436	119505M001	K060330	12555153	38197
119209F610	K060433	1195088R00	K040317	12555153	38025
11920BX000	K040420	119508J100	K040305	12555425	38196
11920BX005	K040328	119509F610	K040335	12555609	38001
11920CK000	K060418	11950AR000	K040372	12556612	38008
11920F4200	K060400	11950VW100	K040490	12557554	38041
11920F4200 / 1172067AX0	K040400	11952-1B000	38044	12557682	38258
11920VW000	K040354	1195575000	38340	12557682	38006
119233S502	36116	119557S000	38340	12557819	38001

					
12557838	38153	12564759	K060870	12569505	K060815
12557838	38006	12564761	K060950	12569528	K040420
12559325	38194	12565153	K060690	12569531	K060915
12560344	38195	12565372	38159	12569536	K050887
12560344	38008	12567397	38009	12569538	K060744
12560345	38196	12568172	38006	12569543	K060905
12561094	38103	12568181	38194	12569736	38006
12561094	38008	12568181	38008	12570215	K060888
12563083	38104	12569301	38328	12570499	K030245
12563083	38009	12569301	38009	12571918	K060888
12563084	38105	12569301	38008	12572188	K060802
12563084	38001	12569348	K060930	12573024	38178
12563097	38043	12569349	K060868	12573024	38018
12563097	38006	12569350	K060950	12573024	36101
12564401	38006	12569351	K060875	12574914	K060663
12564505	38006	12569351	K060870	12575215	K060905
12564508	38271	12569376	K060864	12575216	K060915
12564510	38001	12569435 / 6PK2355	K060930	12575425	K060815
12564711	38006	12569504	K060919	12575509	38397







					
12576446	K040365	12579228	K040398	12583316	K060882
12576447	K040378	12579229	K060798	12584310	K060930
12576450	K060923	12580162	38158	12585310	K030310
12576450 / 6PK2345	K060923	12580162	38009	12587295	38006
12576451	K060930	12580196	38159	12587999	K060900
12576453	K060950	12580196	36169	12588410	K060703
12576454	K060875	12580296	38103	12589978	19768
12576455	K060960	12580296	38008	12590622	K060935
12576750	K060905	12580771	38001	12593776	K060915
12577764	38104	12580773	38001	12594450	K060935
12577764	38009	12580774	38008	12594619	K060882
12577771	k061093	12580826	K060915	12595289	38462
12578000	K060465	12580828	38260	12603527	38420
12578002	K060473	12580828	38009	12603527	38009
12578002	K060468	12581177	38259	12608660	K060938
12578060	K050507	12581700	38006	12612519	K050407
12578062	K050370	12581701	38009	12676451	K060930
12578274	K061098	12582004	38006	12755038	22937
12578869	K060870	12582014	38341	12785038	22937







					
12787608	21591	14400PAAA01	T244	1657122170	22757
13073AA142	T42023	14400PMMA01	T312	1657131130	22844
13085AA080	T42024	14400RCAA01	T329	1657150150	21660
13405PAAA03	T186	14510P0GA01	T41015	165720D120	22758
1350250011	T42031	14510P8AA01	T41090	165720H090	23179
135030F010	T42031	14510PGEA01	T41090	165720P020	22845
1350350011	T42031	14510PV0003	T41020	165720P070	23154
1350362030	T42030	15241777	23163	1657221090	23146
135050F010	T41078	15263235	22129	1657228210	23142
1350550030	T41078	15263236	22917	1657231170	22845
1354020021	T43096	15270253	23164	1657250150	22491
1354020030	T43098	15769077	22437	1657321060	23145
1354050030	T43097	15854959	22554	166030W010	36119
1356809070	T298	1626150090	18201	166030W030	38001
1356829025	T257	165710D150	22757	166040F010	36026
1356859095	T298	165710H100	23178	1660450030	36026
135951 / 178472 / 178630 / 347190 / 587168 / 617122 / 850845	K060470	165710P020	22844	166200W036	38173
14103118	38019	165710P070	23153	166200W100	38173
14400P8AA02	T286	1657121120	22556	166200W101	38173







					
1662022011	38286	1C0122101AN	22407	1L2Z8620AB	K060858
1662022013	38286	1C2Z8620LA	K081223	1L3Z 8678 AB	38001
1662028010	38216	1C2Z8620NA	K081213	1L5Z 6B209 AA	38155
1662028011	38216	1F1Z 6B209 AA	38186	1L5Z8620AC	K060827
1662028040	38216	1F1Z6B209AA	38186	1L5Z8620BC	K060730
1662031012	38411	1F1Z8620BB	K060815	1R3Z8620BA	K060935
1680600QAB / 7700111671	T1095	1J0122051H	22808	1S558B273AA	CH-13014 2
1752166J00	K040372	1J0122051J	22566	1S558B273AA	CH-13013 2
1754077EA0	38156	1J0122101R	22876	1S558B274BA	CH-13012 1
1754077EA0	38010	1J0122101R	22875	1S658B273BA	CH-13029 2
1754077EA3	38010	1K0122051AS	23074	1S658B274AA	CH-13028 1
1754078J00	38397	1K0122101DC	23075	1S7Q19A216AC	38006
1784166J00	23157	1L2E 19A216 AC	38001	1W7Z8620AA / 3W7Z8620AA	K060910
1785166J00	23158	1L2E19A216AB	38022	1X4Z 6B209 AA	38279
1785280J00	23353	1L2E19A216AC	38001	201927 / 617140 / 721211 / 753681 / 950860 / 952262 / 958550 / 966702 / 967135 / 967265	6413 GS
1785480J00	23354	1L2E8620DA	K061010	2020019	38082
19129794	22090	1L2Z 6B209 AA	38274	208045151 / 231000118 / 2310001018 / 2310001022 / 112470AK29 / 1S1193	PQ17540
19129795	23140	1L2Z 8678 AB	38001	21007457	38026
1C0122051G	22615	1L2Z6B209AA	38274	211715023	9455







					
211792023	9365	215035M001	CH-18006 ?	22698699	23124
2150100QAA	CH-18019 1	215038J110	22964	22709846	23166
2150100QAA / 2150100QAB	CH-18019 1	21503CA000	23289	22709847	23165
215015M000	CH-18005 1	21503EA000	23347	242268C2 / C3AE8620C / C3OE8620 B / C3OZ8620A / C4AE8620G / C4EA8620G	T014
215018J110	22963	21503EA200	23252	2431202701	T1013
21501CA000	23288	21503EL000	23307	2431226001	T124
21501EA000	23346	21503ET000	23286	2431542200	T1096
21501EA200	23251	21503F4006	CH-18020 ?	24315-42200	T1096
21501EL000	23306	21503F4200	CH-18001 ?	2441002550	T41241
21501ET00A	23285	21503F4204	CH-18001 ?	2441026000	T41037
21501F4200	CH-18001 1	21503JA000	23345	2441032020	T41044
21501F4201	CH-18001 1	21503JA100	23352	24418248	K050400
21501F4204	CH-18001 1	21503JA100	23351	24430296	38177
21501JA000	23348	21503VW200	CH-18014 1	24430296	38011
21501JA000	22353	21504VW200	CH-18015 ?	24435940	K050405
21501JA100	23350	21569376	K060864	24435953	K050345
21501JA100	22353	22682503	22822	24441692	K060870
21501JP00B	20776	22682505	22688	24451895	T1094
21501VH000	K040360	22698697	23122	24466972	K050405















					
24466973	K050400	24574843	38015	2843209 / 3418459 / 3418459 / 3514175 / 3514176 / 3514179 / 3514181 / 3518449 / A8AZ8575F / C3AZ8575A	8400 GS
24466975	K050402	24575354	38247	2891403 / 2891493 / 2891504 / 2891515 / 2891600 / 2891661 / 26002838 / 26002839 / 26004124 / 26004126	6340 GS
24466976	K050345	24575354	38032	2C2Z8620DB	K060990
24501383	38268	24576073	38165	2C2Z8620JA	K061025
24502735	38269	24576073	38015	2C3Z8620DA	K060806
24502736	38015	24576784	K050630	2C3Z8620EB	K060997
24502989	38009	24576786	K060637	2F1Z 6B209 BA	38114
24504818	38152	24576968	38006	2L3E6B209BA	38138
24504818	38015	2481026020	T42016	2L3Z 6B209 BA	38138
24506756	38009	25135 / 70070 / 178723 / 212589 / 619486 / 950851 / 952292 / 966392 / 967119 / 967246	PQ17420	2L3Z 6B209 CA	38329
24506756	38006	2521202500	K040300	2L3Z6B209BA	38138
24507270	38198	2521226000	K040332	2L3Z8620CA	K060802
24507270	38027	2521233060	K040385	2L3Z8620DB	K060990
24507524	38007	2521542081	K040420	2L5E8620AA	K060882
24508594	38289	25476968	38006	2L7Z8620AB	K060984
24508595	38289	25530872 / 8101419970 / 453654AB / 4612894AB / 461289AAB / 461289AAC / 461589AB / 93886A228AE / E7TA6B209EA /	6390 GS	2N158B273AE	CH-13027 2
24508595	38006	25775994	23338	2N158B274AB	CH-13026 1
24574840	38011	25779559	23337	2N1Q6C301CA	K060878
24574843	38164	273458 / 4592098 / 4596198 / 5352594 / 5358177 / 6410160 / 6410665 / 6410691 / 6410962 / 12474637	6380 GS	2R3Z8620AC	k060960

					
2R3Z8620BC	K080751	30777531	K050350	38903119	37012P
2R3Z8620BC	K060935	31110PLAE02	K060338	38920P8CA02	K060461
2S658B273AC	CH-13029 2	31170P8AA01	38169	38920P8FA02	K060468
2S658B273AC	CH-13023 2	31170P8FA01	38169	38920PAAA02	K060435
2S658B274AD	CH-13022 1	31170P8FA02	38322	38920PLR003	K060388
2S6G6C301AA	K060882	31170PGKA01	38327	38920PNB003	K070683
2S6G6C301AA / 1132953	K060882	31170RAAA01	38278	38920-PWA-901	K050450
2S6G6C301BA	K060856	31170RAAA02	38278	38920RAAA02	K070701
2S6G6X301BA	K060856	31170RCAA01	38332	38920RCAA03	K060840
2W4E8620AA	K061080	31180P8CA01	38001	3C2Z 6B209 AA	38257
2W7E 6B209 AA	38189	31180P8FA01	38001	3C2Z 6B209 CA	38257
2W7Z 6B209 AA	38189	31190PCX000	36100	3C3E8620DA	K081265
30020683	K050609	31190RCAA02	36112	3C3Z 8678 BB	38022
30026799	K040365	313853 / 366775 / 366775 / 960457 / 960501 / 960545 / 960589 / 966696 / 966869 / 966920	PQ17550	3L1E8620AA	K061005
30026857	K040400	377121051C	CH-22085 2	3L1Z8620AA	K061005
30026873	K050650	377121101C	CH-22084 1	3L2E 6C348 AA	38001
3038094 / 3043066 / 3043068 / 3046544 / 3050922 / 4425620 / 8132282 / 8134146 / 69121113 / 69121113	6400 GS	377145299	TMV-2200 2	3L2E6C348AA	38001
30577561	33189	377260299 Y 40097001	TMV-2200 1	3M4Z 6C348 CA	38008
30777530	K050355	3815996 / 4428261 / 6410233 / 10055798 / 10105371 / 10183939 / 12558520 / 12560344 / 12561092 / 443201551AB	PQ17490	3M518K012AA	35B 1/4







					
3M518K312BA	35B 5/16	4451A074	K061010	4667606	T245
3S4Z6A228AA	38408	4483221	38034	4668241	K040335
3S5Q6C301AA	K060882	4573974	K060529	4668241AE	K040335
3S6G8575A2A	33238	4593684AA	K060825	4668247AG	K040520
3W4Z 6B209 AA	38279	4593805AB	38417	4668380AD	K040345
3W7E 19A216 AA	36100	4596835AB	22943	4668380AE	K040345
3W7E 6B209 AA	38189	4596861AB	22942	4668444AC	K040510
3W7E6B209AA	38189	4596874AE	22941	4668509AB	38176
3W7E8620AA	K060908	4596886AE	22940	4668509AC	38176
3W7Z8620AA	K060910	4612894 / 4612889AAC / E5PZ8620B / E83E8620GB / E83E8620HA / E83Z8620E / E83Z8620HA / MJK62039 / MB42471 /	K060837	4750220	38179
40098103	K060590	4612894AC / F13E6B209A / F13E6B209AA / F13Z6B209A / F1A6B209A / F23E6B209CE / F23E6B209EA / F23E6B209EB /	K060935	4750220	38009
4315705	T41001	461289AAB / F27A 6B209 BB / F27A 6B209 FA / F2AE 6B209 AA / F2AZ 6B209 A / F2TZ 6B209 A / F2TZ 6B209 B / F2TZ 6B209 D /	K070855	4773545	T285
4333455 / 4333566 / 4333600 / 4401153 / 4401157 / 4456516 / 4470767 / 4470971 / 4495721 / 4495805	6263 GS	4621844	T265	4773842	TCK285
4335876	K060820	4621884	T265	4777394	T41002
4356127	38083	46541764	K030267	4781569AB	T42121
4401493 / 5352954 / 5900584 / 6410427 / 6410785 / 10036879 / 10283897 / 10409635 / 14099684 / 15953298	8334 GS	4661066	K060923	4792071	K060420
44121113	33209	4663534	38040	4792112	38042
4429254	38157	4663950	7550	4792112AD	38042
4451A062	K061033	4667606	T254	4792112AE	38042







					
4792259AB	36100	4891598AB	K061005	4L2E8620EA	K060854
4792259AC	38009	4891692AB	K060802	4L2Z8620EA	K060854
4792298 / 10108694 / 10182355 / 12551958 / 12554955 / 12555685 / 21006565 / 21007200 / 21007373 / 24100190	6567 GS	4891720AA	38018	4L3Z8620EA	K060832
4792353	T295	4891721AB	K061015	4L5Z8620CA	K061010
4792581AA	38043	4891875AA	K060695	4L8Z 6B209 AA	38279
4792835AA	38018	4892444AA	K040353	4L8Z6B209AA	38279
4792836AA	38082	4892749	K040353	4L8Z8620AB	K060840
4854033AB	K060882	4898755	38226	4M5Z8620AA	K060832
4854089AB	38163	4899449	22932	4R338620EA	K061015
4861277AB	38185	4899548	K061031	4S4Q6C301CB	K060874
4861277AD	38185	4899555	K060795	5010371AA	T43005
4861322AB	K060825	49633872	22931	5037542AA	K060815
4861322AC	K060825	4963872	22931	5072277AA	K040300
4861660AA	38323	4964789	21701	5072279AA	K040295
4861850AA	K060938	4967907	36079	5080246AA	38082
4861850AB	K060935	4968590	36079	5080633AA	38157
4871721AB	K061015	499031372	TH11287G 1	5086958AA	38285
4891519AC	K040551	499031372	7374GS	5096525AA	38174
4891519AD	K040551	499031372	7371GS	5193362	22936







					
5194261	22934	53010306	K070903	53032805AA	K071009
52028988AB	22896	53013209AC	K060750	53032805AB	K071009
52028989AD	22897	53013324AA	38006	53032817AA	K060868
52029281AA	23041	53013352AD	K060849	53040171	K080810
52029284AD	23042	53013676AB	K060820	55032037AI	K060874
52477552 / 94153251 / 94408139 / 97104194 / 19045PAA51 / 19045PCA004 / 19045PR7A07 / 19045PR7A08 /	8354 GS	53013905AC	K060868	55116865AC	23035
5281351AC	K060919	53021582AD	38323	55116868AB	23036
53002903	38019	53030958	38167	55191970	K050455
53002905	38042	53030958AC	38167	55556404	K060837
53009508	38033	53030958AD	38167	55563222	K060956
53010150	K060923	53032037AI	K060874	556343 / 966696 / 966869 / 966920 / 967050	6463 GS
53010158	38116	53032037AJ	K060868	5636721/5636722/90353176/90499101/911176 95/9202478	TPG-1400 2
53010158AB	38116	53032037AL	K060876	56992P0AJ01	K040418
53010230	38043	53032125AD	K060882	56992P8AA01	K040438
53010230L	38043	53032129AA	38058	56992P8AA1	K040438
53010240	38180	53032130AA	38382	56992PLM003	K040398
53010257	K060790	53032132AK	K071013	5718143100	6470MC
53010303	K070975	53032380AD	K060882	571814A000	K040415
53010305	K071005	53032645AA	38058	5750LG	K060672







					
5750RG	K060355	5X0260849	K060888	6E5Z8678AA	38006
5750VE	K060630	6012001070	38090	6K0121051A	CH-22070 2
5750VG	K060680	617163 / 619524 / 950813 / 952132 / 960288	6417 GS	6K0121051H	CH-22083 2
5750WQ	K060630	619519 / 966919 / 966981 / 967049 / 978536	6450 GS	6K0121101A	CH-22071 1
5750XG	K060400	6230725 / F2UZ8620D / F3UA8620AAA / F3UZ8620E / F4UA8620AAA	K061025	6PK1049	K060413
5750XK	K060630	62923 / 617111 / 950821 / 952140 / 960296	6494 GS	6PK2075	K060815
5750YE	K060615	63735 / 550865 / 554709 / 556727 / 559346 / 617113 / 6003051 / 6410231 / 6410363 / 549107R1	8470 GS	70017 / 70105 / 178427 / 185126 / 203421	8473 GS
57931 / 976490 / 978543 / 978544 / 978545	6480 GS	674178 / 958349 / 958394 / 958439 / 966932 / 966959 / 966998 / 967026 / 967071 / 973535	6405 GS	70078 / 70172 / 70482 / 134823 / 178440	PQ17460
58260511	38068	686395 / 966934 / 967000 / 967073 / 978587	6574 GS	70091 / 70098 / 70167 / 118637 / 134825	8445 GS
5L3Z 6B209 AA	38138	69159 / 70113 / 100402 / 100442 / 117200	8553 GS	70103 / 70161 / 600452 / 950849 / 952251	PQ17430
5L3Z 8678 BA	38001	69265 / 69668 / 130230 / 178409 / 178558	8345 GS	70107 / 155149 / 182808 / 189527 / 189917	8494 GS
5L8Z8620AB	K060895	69311 / 103811 / 154849 / 178374 / 178459	8324 GS	70112 / 201927 / 617140 / 721211 / 753681	8543 GS
5L8Z8620BB	K060854	69312 / 69489 / 129949 / 178375 / 178557	8310 GS	70115 / 178449 / 617129 / 617130 / 617131 / 619515 / 629028 / 952265 / 958544 / 966395	8523 GS
5PK1028	K050405	69393 / 70119 / 178386 / 188839 / 239495 / 344212 / 619524 / 950813 / 952132 / 960288	6436 GS	70151 / 674178 / 966932 / 966998 / 967071	6563 GS
5S4Z8260AA	23297	69405 / 178388 / 303291 / 550681 / 950843	8371 GS	70161 / 600452 / 950849 / 952251 / 958767 / 967115 / 967185 / 967242 / 978714 / 978715	8430 GS
5S4Z8286AA	23276	69594 / 178406 / 215356 / 460710 / 958313	6433 GS	70168 / 70182 / 109179 / 178479 / 958489	8389 GS
5X0145271 / 6PK1741	K060683	6C1Q6C301CC	K060660	70172 / 70482 / 134823 / 178440 / 178623 / 313748 / 617135 / 617136 / 683589 / 858542	PQ17450
5X0260849	K060895	6E5Z6C348AA	38008	70183 / 966928 / 966994 / 967067 / 978572	6543 GS
5X0260849	K060894	6E5Z8620CA	K060919	70190 / 178495 / 619507 / 966389 / 967193	8510 GS















					
70342 / 178434 / 469583 / 958307 / 958397	6370 GS	7D0121049AS	CH-22077 2	8627484	T331
70342 / 178434 / 469583 / 958307 / 958397	6364 GS	7D0121049AS	CH-22076 2	8724506460	19467
70495 / 178441 / 178452 / 414907 / 419377 / 419407 / 460481 / 617108 / 618626 / 619518	8500 GS	7D0121049AS	CH-22075 4	8724507120	19468
7083436	T203	7D0121049AS	CH-22074 4	8724507130	19469
73131AC010	38030	7T4E6C301AB	K040365	8844004030	38031
73131FC000	38030	7T4Z8620C	K061020	88621 / 619480 / 958359 / 958404 / 958449	6444 GS
741210568	TH-35087 21	802220005 / E4EE8620KA / E4FZ8620A / GT4050355	K050355	88DY8620AA / E8SE8620BA / E8SZ8620B / F3TA8620ZA / F3TZ8620A	K061020
743 / 10000743 / 25532290 / E8DE6B209DA / E9DE6B209BA	38005	81698	T1504	89017309	38103
747 / 10000747 / 10040810 / 10041248 / 10066698	38002	8200061673	K050435	89017309	38008
76145933	K060790	8200064664	T42166	89023410	23079
7700111671	K050688	8200098343	T1565	89023411	23078
7700114860	TPG-2000 4	8200098343	T1284	893N8260AA / 893Y8260A / D8BD8286AA / MKM2014	CH-13101 2
7700872554	TH-23389 24	8200098343 / 7700100531	T1284	8943864883	T42002
7701477014	TCK1095	8200206889	K050446	8970616670	36099
77903341	38093	8200226493	K060653	8971160020	T41028
7811803 / 7815415 / 7818348 / 7818878 / 7828530 / 7828722 / 7829871 / 7830184 / 7830756 / 7833395	PQ17530	8200243021 / 8200821813	K060472	8971160031	T43095
7D0 121 049 AQ	CH-22077 2	820046148	T1565	8971258601	38266
7D0121049AQ	CH-22077 2	8200821813	K060472	8971362560	T41028
7D0121049AQ	CH-22076 2	8200833549	K060708	8971468770	T42115

					
8971783540	38008	9091602547	K060739	9128500	T285
8S4Z8620A	K060876	9091602571	K070834	9128722	T305
9004A91034	K060740	9091602585	K060882	9128725	T1022
9008091088	K040347	9091602599	K070763	9129463 / 6PK1460	K060578
9008091134	K060605	9091602639	K070735	9157962	38009
9008091136	K060739	9091602640	K070901	9194660	K050478
9008091139	K060739	9091602652	K070750	9201887	TCK285A
9008091147	K060408	9091602653	K070750	9202550	38179
9008091223 / 6PK1770	K060696	90916A2001	K070834	9202550	38009
90409238	T36038	90916A2002	K070763	92063694 / 8920636940	7417
90500229 AA	38200	90916A2004	K060882	92063695 / 8920636950	9378
90510025 / 93421207 / M JK6 2043 / MJJ 361	6362 GS	90916A2010	K070825	92063917	T309
90528760	38179	90916A2013	K060878	92065303 / 8920653030	T1502
90528760	38009	90916A2018	K060480	92067442	K060763
9091602310	K060763	91174492	K030195	92068267	K061010
9091602463	K060882	9117589	K050370	92068285	K040430
9091602499	K040360	91176512	38156	928F 6C301 CA / E6AE 8620 HA / E7DZ 8620 A / F0DE 8620 DA / F5DE 8620 AC	K060750
9091602500	K040465	91176512	38010	928M6268A1B / F5RZ6268A	T258
9091602502	K070763	9120501	TCK285	93268090	K060663







					
93268090	K060660	94BB6C301AC / 94BB6C301AD / F5RZ8620AD / F5RZ8620G	K060682	96180071	21667
93268090 / 6PK1680	K060660	94BB6C301BB / F5RZ8620C	K060735	96183108	K060739
93363910	K050715	950853 / 952255 / 958588 / 960514 / 966393 / 966394 / 966857 / 967123 / 967124 / 967188	8533 GS	96183113	38024
93363910 / 5PK1813	K050715	951075 / 960333 / 960377 / 960421 / 966381	6427 GS	96184932	38200
93424264 / 6PK2385	K060938	9513086Z00	38273	96239408	K040262
93424938 / 93428008 / 93428628	CH-14044 4	9513086Z00	38018	96298799	38200
93429152 / 357165C1 / C7JZ8620P / D4PZ8620J / D4TE8620DA / D7UE8620CA / E1PZ8620A / GT13326 / GT15332 /	K060615	9514154G61	K050658	96309968	K060744
93429162 / 111 903 137 D / 111 903 137 E / M JK6 2043	7362 GS	9514164J20	K040430	9631203080	T901
93429178 / E43E8620UA / E43Z8620N / MJK6386	K060380	9514167D10	K040425	96349976	38376
93429179 / 037 903 137 H / 11920 53J00 / 43Z 8620 B / E43E 8620 GA	K060408	9516085Z00	38200	96349976	38015
93429179 / 037903137H / 1192053J00 / 43Z8620B / E43E8620GA	K060408	9516085Z01	38200	96350550	T43039
93429181 / E2SE8620PA / E2SZ8620 / E2SZ8620E / MJK6782	K060772	952120 / 958299 / 960276 / 960320 / 960364	6294 GS	9638027180 / 6K1585	K060623
93429183 / 89Y8620AA / F77E8620GA / F77Z8620GA	K060882	952286 / 966999 / 967072 / 976496 / 978585 / 978586 / 1551007	K060806	9639842180	T1581
93429186 / E9SE8620JB / E9SE8620JC / E9SZ8620H / F2UA8620RA	K060988	958299 / 960276 / 960320 / 960364 / 960408 / 966893 / 966950 / 967017 / 2026615 / 3040483	6500 GS	96417177	T335
93429190 / F1SE8620AA / F1SE8620CA / F1SZ8620A / F1SZ8620B	K061080	958350 / 958395 / 958440 / 966904 / 966961	6352 GS	96459042	38200
93429195 / E9SE8620HB / E9SE8620HC / E9SZ8620D / E9SZ8620J	K080897	95WF19A216AC / 95WF19A216AD / 98BB19A216AA / 98BB19A216AB / F8RZ8678BA	38018	96459042	36152
9480 / 69393 / 70119 / 178386 / 188839	8484 GS	960299 / 966927 / 966992 / 967065 / 978568	6530 GS	96498019	38273
9480 / 70106 / 618386 / 978753 / 978754	PQ17480	960506 / 960550 / 960594 / 967108 / 967177 / 967234 / 977542	K060875	96498019	38018
94847233 / 94854943 / 96051840 / 96051843 / 96062603 / 19045PM3003 / 19045PM3004 / 19045PR3003 / 19045PR3004 / 19045PR3005	PQ17440	96058052 / F0BZ 8620 C / F0C63F572AA / F0CZ 8620 C	K040315	96536532	21531







					
96536592	20942	978694 / 8EL8260C / 8EL8620C / 8EL8620D / 998206R1 / A37608 / B8E8620E	K060984	A0149971792 / A0149970492	K060895
96536598	22918	978695 / C0AE8620M / C4RA8620F / C4RZ8620E / D6DE8620FA / D6DE8A615EA / EDC2875B	K061145	A6112000570 / A6462000270	38415
96553247	22913	978787 / 978788 / 2612430 / 2612431 / 3003035 / 3040315 / 3542796 / 4037207 / 4094880 / 4094881	8573 GS	AJ5715980	38308
96553316	22914	97BB6C301BC / F8RZ8620BA	K060802	AS015907A / AS0115907B / AS0115907BA / E02E8620AC / F02E8620AB	K040355
966919 / 966981 / 967049 / 978536 / 2951304 / 3932438 / 3935421 / 4027321 / 4041437 / 14017797	8594 GS	9806163 / E7UA8620ALA / E8UZ8620K / F3NN8620AA / F4DE8620AA	K061005	AS0315909B / F02E8620BAX / F12E8620AB / F228620A	K060703
966928 / 966994 / 967067 / 978572 / 978573 / 3040511 / 4494469 / 4494469 / 9787574 / 52028185	PQ17400	988Z6268B2A	T294	B7S8620A / C2OA8620A / C2OE8620A / C2OE8620C / C2OE8620F / C2OE8620S / C2OE8620Y / C2OE8A615A	6364 GS
967111 / 967180 / 967237 / 208045078 / 0079971692	8405 GS	98BB6C301BA	K060827	C2AE8A615B / C2AE8A615C / C2AZ8620A / C2AZ8620H / C2R8620L / C2TE8620BD / C2TE8620E / C2TE8A615AE / C2TE8A615Z	K060966
97221943	38008	98BZ 8678 AB	38018	C2OE8A615G / EDC8620E / EDJ8620C / EDJ8621A / EDJ88621A / GT13431 / GT15435 / GTFLN7430	K060465
97288625	38172	98SF6C301EA	K060667	C4DE8260B / D9HZ8548A / D9HZ8548B / D9TE8548AA / E0HS8548AA	CH-13005 2
97288625	38008	98SZ8620DA	K060500	C5OE8620G / C7JZ8620A / D2AE8620AMA / D2AE8620BFA / D2HA8A615AA / D2HA10C318AA / D2PZ8620A	K050336
97329062	38172	98SZ8620EB	K060667	C7JZ8620D / C9PZ8620R / C9PZ8620S / CC4TA8620AX / CC4TE8620AC / CC4TZ8620AX / CC4TZ8A615A /	K080720
97329062	38008	99245054	9380	CW750993	K040390
9765243010	6469MC	9933211205	9470	CW750994	K040390
9771328240	K040370	993642110	K040430	D0VZ8620B / D2AE8620BSA / D2AE8620BSE / D2OE8620AYA / D2TE8620AT / D2TE8620ATA	K050435
9783422000	36086	99367C2090	K070825	D5HA8A615BBA / D5HA8B615BBA / D5PZ8620F / D5TA8620MA / D5TA8A615BBA / D5TA8A615BRA /	T067
9783422100	36086	99610215164	K060832	D5HE8620HA / EBU2890A / ECU33558A / GT17426 / GTFLN9425 / MJK62020	K060915
978691 / 2612074 / 3040513 / 4027301 / 4100677 / 4106241 / 4559195	K060919	99660315250	37014P	D8BD8260AA / MKM2004	CH-13100 1
978692 / 93429160 / 208045106 / 2314A067 / 2614A167 / 3138935R1 / 358344C91	K060956	A0002020019	38099	D9AD8260AB / MKM2005	CH-13102 1
978693 / 3N6588 / 3N6589 / 681741R1 / 681741R11 / 681741R2 / 8BE8620E	K060960	A0149970692 / A0089977092	K060888	D9PZ8620K / E02E8620AA / E2AE8620AA / E3AE8620AA / E8TZ8620C	K060938

					
D9PZ8620U / E0TA8A615BA / E0TE8A615BA / EBJ8620B / GT17522 / GTFLN9520	K060923	E4EE8620NA / E4FZ8620G	K060420	E8TZ 8678 E	38012
DOAM8597A / MKM2036	CH-13104 2	E55E8620AA / F5AE8620AA / F5AZ8620A / F5AZ8620AA / F5TZ8620C	K060975	E8TZ6B209A / E8TZ6B209DA / F2TA6B209DA / F2TZ6B209C / F2UA6B209AB	38115
E1AE8620BA / E1AE8620DA / E1AZ8620A / E2AE8620MA	K060620	E59D8286AA / E5SD8286AA	CH-13118 2	E95E8620AB / E9SE8620A2B / E9SE8620AA / E9SE8620AB / E9SZ8620G	K070425
E1AZ8620B / E37E8620JA / E3TZ8620F / E3TZ8620R	K060605	E5AE8620FA / E5DE8620BA / E6SE8620AA / F3TZ8620B	K060878	E9D8286CDCB / E9DE8286CD	CH-13839 2
E1EE 8620 DB / E1FZ 8620 L / E2EE 8620 CA	K040285	E5AE8620JA / F3DZ8620A / F8KZ8620BA	K060854	E9FZ8620E / F0EE8620BE / F1CZ8620E / F2CE8620BC / F2CE8620EB	K060535
E1ZE8620BA / E1ZZ8620A / E4DE8620CA / GT4060825	K060825	E5SD8260BA / MKM2010	CH-13117 1	E9SE 8260 DA / E9SE 8260 EA / E9SE 8260 EA,DA	CH-13838 1
E27A8620AB / E7TA8620AFA / E7TA8620AFB / F27A8620AB / F2TZ8620A	K060895	E5ZE8620DA / E5ZZ8620A / E7TA8620ARA / E7TE8620ARA / E8TZ8620M	K060970	E9SE8620FB / F4SE8620EA / F4SZ8620D / F4SZ8620F	K080392
E27A8620BB / F07A8620AA / F0TZ8620A / F19Z8620C / F27A8620BB	K060870	E6AE8620GA / E6AZ8620B	K060507	E9SH18D359AG / E9SH18D359AG	CH-13838 4
E27A8620MA / E8PZ8620C / F27A8620MA / F47Z8620E / F5RZ8620B	K060721	E73E8B273CA / E73E8B273CAN / MKM2016	CH-13116 2	E9TD8286AA / E9TD8286AB	CH-13128 2
E27E8620BB / E37E8620HA / E37E8620KA	K060612	E7DE8620JA / E8DE8620EA	K060710	ERR3440	38246
E2DE8620BA / E2DZ8620B / E3AZ8620A / E7TA8620ASA / E7TH8620ASA	K060980	E7LE6B209AA / E7LY6B209A / E7ZE6B209AA / E8ZE6B209AA / E8ZE6B209BA	38121	ERR6439	38245
E2SE8620RA / MJK6782	K060775	E7SE 8620 CA / E7SE 8620 CB / E7SZ 8620 B / E8SE 8620 EA / E8SZ 8620 E	K060365	F0TZ8620B / F37A8620ARA / F3DZ8620D / F47Z8620A / F49A8620UA	K060810
E2SZ8620B / E6AE8620EA / E6DZ8620C	K060525	E7TA8620AMA / E7TA8620AMB / E7TA8620MB / E7TE8620AMB / E7TZ8620A	K060990	F13E6B209A / F13E6B209AA	38117
E2ZE8620CA / E8TA8620MA / F0TA8620JA / F1TA8620JA / F0TA8620JA	K060910	E7TA8620ANB / E7TZ8620C / E7UZ8620E / E7UZ8620J / E8UZ8620H	K061000	F19A8620HA / F49A8620VA / GT4060868	K060868
E43D8260AB / MKM2009	CH-13115 1	E8DZ6B209A / F3DZ6B209B / F4SZ6B209B / F78Z6B209AA	38127	F1DZ8260A / FIDZ8260A / MKM2051	CH-13106 1
E43E8620HA / E43E8620LA / E43Z8620C / E43Z8620H / E59E8620BA	K060480	E8DZ8620E / E8TA8620PA / E8TZ8620R / F0TA8620XA / F0TZ8620J	K060685	F1SZ8286A / FISZ8286A	CH-13112 2
E43E8620PA / F02E6B209BG / F02E6B209BH / F02E6B209E / F02Z6B209B / F02Z6B209C / F02Z8678A / F07Z6B209AA /	K060705	E8PZ8620A / F4BZ8620A	K040345	F27A6B209FA / F2TZ6B209B / F3DE6B209AB / F3DZ6B209C / F59E6B209AB	38114
E45L8620A / E5AE8620GA / E5LY8620A / E5ZE8620BA / E6SZ8620A	K060930	E8TA 8620 CA / F0UA 8620 GA / F2UA 8620 CA / F67Z 8620 KC / F87E 8620 KB	K060942	F2TZ 6B209 A	38155
E4EE 8620 MA / E9EE 8620 AA / E9FZ 8620 B	K060355	E8TA8B274HA / F1TA8B274TA / F4TM8260A / FITA8B274TA / MKM2360	CH-13558 1	F37Z6B209A / F3TZ6B209C / F47E6B209AA / F77Z6B209AA / ZZM815980	38102

					
F3AZ8678A / F3DE6B209AB / F3DZ6B209C / F3LY6B209A / F3TA6B209GA / F3TZ6B209B / F3ZE6B209AA / F3ZZ6B209A /	K050340	F53E8620AB / F5RZ8620F	K060716	F75Z8678AB	38001
F3DE 8620 CA / F3DZ 8620 E / F78E 8620 EA / F78Z 8620 EA	K060849	F53E8620BB / F5RZ8620E	K060623	F77E8620JA / F77Z8620JA	K060864
F3DE8620BB / F3DZ8620C / F57Z8620C / F77E8620FA	K060815	F53E8K543AA / F5RZ8620A	K030267	F77E8620MA / F8RZ8620AA	K060858
F3TD8B273CA / F0TD8286AA	CH-13900 ?	F57Z 6B209 A	38155	F79Z6B209AA	38114
F3TZ6B209B / F5TE6B209BA / F5TZ6B209D	38123	F5RZ 6B209 AA	38250	F7CZ 6C348 AA	38001
F3UA8620CA / F4SZ8620A / F5UE8620BA	K060994	F5RZ 8W508 A	38276	F7CZ6268AA	T283
F3UZ8620F / F3UZ8620G / F4UA8620ZA	K060997	F5RZ8620A	K030267	F7CZ6C348AA	38001
F4DE8620BA / F57A8620CA / F58Z8620A	K060820	F5TZ 6B209 AA	38119	F7RZ 6A228 AA	38160
F4SZ 6B209 A	38298	F6578620JB / F65E8620JA / F65Z8620JA / F65Z8620JB / F7UE8620EA	K080991	F7UZ8620FA	K080806
F4SZ 6B209 B	38127	F65E 19A216 AA	38022	F87Z 6B209 CA	38155
F4SZ 6B209 C	38297	F65E8620GA / F65Z8620GA	K060832	F8CZ 6B209 AA	38162
F4SZ 6B209 D	38299	F65Z 6B209 BA	38161	F8CZ 6C348 AA	38008
F4TA8B273EA / MKM2450	CH-13650 ?	F65Z 8678 AAA	38022	F8KE 19A216 AD	38006
F4TZ 6B209 A	38270	F68E8620AA / F68Z8620AA	K061031	F8KZ 8678 AA	38006
F4TZ 8678 A	38015	F6DZ 6B209 DA	38181	F8RZ8620BB	K060827
F4ZE8620CD / F4ZZ8620C / F4ZZ8620D	K061045	F6TZ 8678 HB	38052	F8RZ8620CA	K060775
F4ZE8620DA / F4ZE8620DB / F4ZZ8620A / F5ZZ8620A	K061058	F6TZ 6B209 EA	38119	F8RZ8620CE	K060837
F4ZZ 6B209 A	38182	F75Z 6B209 EA	38330	F8TZ 6B209 BA	38191
F50E8620AA / F50Y8620A / F60Z8620AA / F72E8620AA	K060755	F75Z 8678 AB	38001	F8TZ8620GC	K081377



					
GQ55351458 / 5PK1028	K050405	MD322330	K040355	MR984778	T168
JK6 922 A	K060919	MD322641	T287	MR994968	T332
JK6-922-A	K060919	MD336149	T232	NPN	38005
L37215909A	K060520	MD352473	T41038	PK1165	K060458
L37215980B	38357	MD365262	K050429	PQS101271L	K060612
L3B615909	K060900	MD365263	K050538	XF2E8620CB	K060960
L3P915980A	38409	MD368275	K060470	XF2Z 6B209 AA	38150
LF1715980D	38408	MD376691	K050370	XF2Z6B209AA	38150
LF5015909	K060514	MN155727 / 4PK1005	K040395	XF4Z8620CA	K060680
LF5015980	38357	MN155728 / 5PK1130	K050446	XR3Z 6B209 AB	38189
LFY115SAXA	K050275	MN158102	K040355	XR3Z 8678 BA	38006
MD140071	T41039	MN158794	K060705	XR83 6B209 AB	38279
MD156604	T42017	MN176972	K060744	XS2E8620HB	K060820
MD182295	T168	MN176973	K060739	XS2Z8620HB	K060820
MD182537	T41054	MN187017	K040355	XS4Z 6B209 AA	38171
MD186376	T201	MN187154	K050425	XS4Z6B209AA	38171
MD307487	T259	MN187176	K040305	XS518B274CC	CH-13012 1
MD319022	T42018	MN187177	K050510	XS618B274CC	CH-13024 1
MD320174	T41212	MR984617	K040358	XS6E6C301AD	K060413

					
XS6E6C301BB	K060670				
XS6E6C301BB / 1089877	K060670				
XW4Z 6B209 AA	38279				
YC2Z8620EA	K080991				
YF1Z 6B209 AA	38114				
YL2Z 6B209 AA	38137				
YL2Z6B209AA	38137				
YL3Z8620BA	K061031				
YL3Z8620CA	K060970				
YS-253	38001				
YS4Z 6A228 AA	38188				
YS4Z 6B209 AA	38275				
YW7Z 8678 AA	36100				
YZ4Z 6A228 AA	38188				









A **Tomkins** Company

Esta es propiedad de Gates de México, S.A. de C.V.  
Queda totalmente prohibida su reproducción parcial o total  
Impreso en la ciudad de México.

Junio del 2010

Gates de México, S.A. de C.V.

Cerrada de Galeana 5  
Fracc. Ind. La Loma  
54060 Tlalnepantla, Edo. de México  
Tel. (55) 2000 2700  
Fax. (55) 2000 2701

[www.gates.com.mx](http://www.gates.com.mx)



# Medidor de desgaste de bandas Micro V® AT

Nueva Generación de bandas... las bandas más silenciosas del mercado



Muestra de desgaste  
Banda antigua



Muestra de desgaste  
Banda nueva

## CALIDAD DE EQUIPO ORIGINAL

Debido al cambio de tecnología y materiales en la construcción en esta nueva generación de bandas, ya no se pueden apreciar las grietas y pedregadas de truenos causadas por el uso. Por esta razón GATES desarrolló el Medidor de Desgaste de Bandas Micro-V® AT, con la finalidad de ayudarte a determinar las condiciones de desgaste en esta nueva generación de bandas.

Lo puedes hacer con la banda instalada en el motor o fuera de él.

## 2 formas sencillas de medir el desgaste



Banda en buenas condiciones

### 1. Banda fuera del motor

Inserte el medidor en un canal de la banda. Si la barra medidora queda más alta que las costillas, esto indica que la banda está en buenas condiciones.



Banda desgastada

### 2. Banda instalada en el motor

Con el motor apagado busque una sección recta de la banda entre poleas y ponga la barra del medidor en un canal de la banda y con el dedo podrá sentir la profundidad de la barra medidora.



### Banda desgastada

Si el medidor se hunde por debajo de las costillas, es necesario cambiar la banda.

### Desgaste desigual de la banda

Si el desgaste no es pareja, esto indica que hay un desalineamiento de las poleas. Lo más recomendable es cambiar la banda y las poleas.





A Tomkins Company

**Gates de México, S.A. de C.V.**  
Cerrada de Galeana 5  
Fracc. Ind. La Loma  
54060 Tlaliscoyotlán, México  
Tel. (0155) 2000 2700  
Fax. (0155) 2000 2701  
[www.gates.com.mx](http://www.gates.com.mx)

**Centro de Distribución  
y Servicio Guadalajara**  
Carretera a San Martín de  
las Flores No. 520  
Parque Industrial Prologia Nave  
3-B  
45029 Tlaquepaque, Jal.  
Tel. (0133) 3697 3440  
Fax. (0133) 3697 3442

**Centro de Distribución  
y Servicio Monterrey**  
Blvd. José López Portillo No. 333  
Int. Bodegas 209  
Col. Valle del Canadá  
66090 General Escobedo, N.L.  
Tel. (0181) 8352 2829  
Fax. (0181) 8352 1398

**Centro de Distribución  
y Servicio Mérida**  
Calle 17 No. 218  
Ciudad Industrial  
97288 Mérida, Yuc.  
Tel. (01999) 948 0348  
Fax. (01999) 948 1409

**Centro de Distribución  
y Servicio Mexicali**  
Circuito de las Misiones No. 188  
Módulo B  
Parque Industrial Las Californias  
21364 Mexicali B.C.  
Tel./Fax (01606) 561 3805 / 561  
1447

**DISTRIBUIDOR AUTORIZADO**

**[www.gates.com.mx](http://www.gates.com.mx)**

**La Marca de Más Prestigio en Bandas, Mangueras, Hidráulica y Neumática**